

user manual

oliso[®]
smartiron[®]

hello

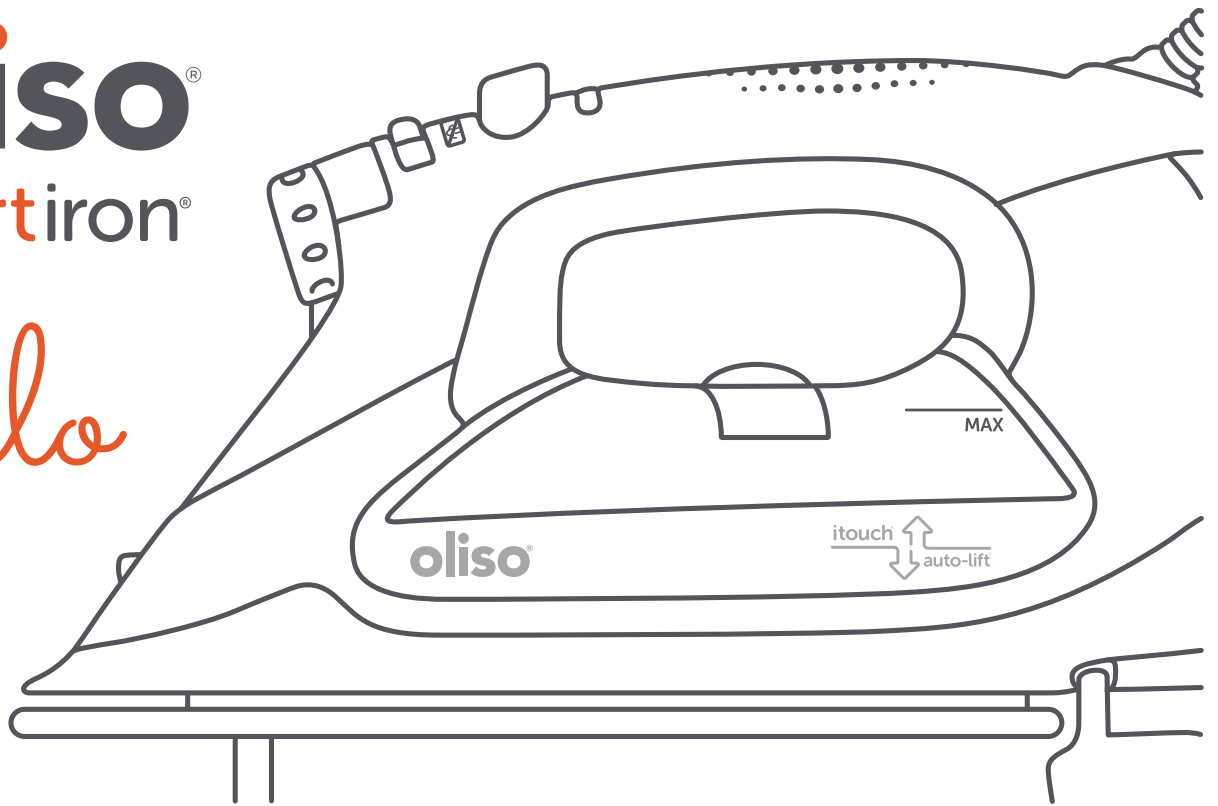

for models TG1050 | TG1100 | TG1250Pro | TG1600Pro

important safety instructions

When using your iron, basic safety precautions should always be followed, including the following:
read all instructions before using this product

- 1 Use iron only for its intended use.
- 2 To protect against a risk of electric shock, do not immerse the iron in water or other liquids.
- 3 The iron should always be turned to "Off" before plugging or unplugging from the outlet. Never tug cord to disconnect from the outlet; instead, grasp plug and pull to disconnect.
- 4 Do not allow cord to touch hot surfaces. Let iron cool completely before putting away. Loop cord loosely around iron when storing.
- 5 Always disconnect iron from electrical outlet when filling with water or emptying and when not in use.
- 6 The iron is not to be used if it has been dropped, if there are visible signs of damage, or if it is leaking.
- 7 Do not operate iron with a damaged cord or if the iron has been dropped or damaged. To avoid the risk of electric shock, do not disassemble the iron. Take it to a qualified serviceperson for examination and repair. Incorrect reassembly can cause a risk of electric shock when the iron is used.
- 8 This appliance is not intended for use by persons (including children) with reduced physical, sensory or mental capabilities, or lack of experience and knowledge, unless they have been given supervision or instruction concerning use of the appliance by a person responsible for their safety.
- 9 Children should be supervised to ensure that they do not play with the appliance.
- 10 Burns can occur from touching hot metal parts, hot water, or steam. Use caution when you turn a steam iron upside down - there may be hot water in the reservoir.
- 11 If the LED flashes orange (not red or green), the iron is not operating normally. Disconnect from the power supply and have the iron serviced by a qualified serviceperson.
- 12 When placing the iron on its stand, ensure that the surface on which the stand is placed is stable.

special instructions

- 1 oliso[®] irons are high wattage appliances - For EU version is 2000-2400W at 220-240V. For US or Canada version is 1600W at 120V for models TG1050 or 1800W at 125V for models TG1100, TG1250Pro or TG1600Pro. To avoid a circuit overload, do not operate another high wattage appliance on the same circuit.
- 2 If an extension cord is absolutely necessary, a 15A cord should be used. Cords rated for less amperage may overheat. Care should be taken to arrange the cord so that it cannot be pulled or tripped over.
- 3 This iron uses hot steam!
- 4 Never direct fill the iron from a water tap while the iron is plugged into a power source.
- 5 **FOR HOUSEHOLD USE ONLY.**

please save these instructions

side view

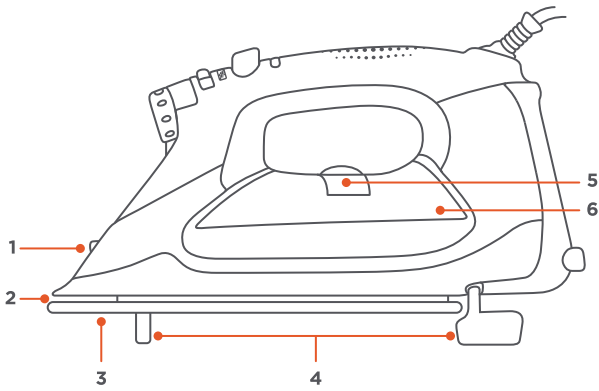



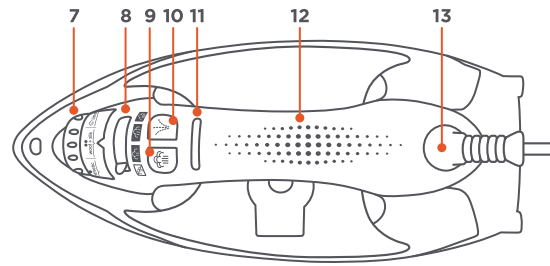



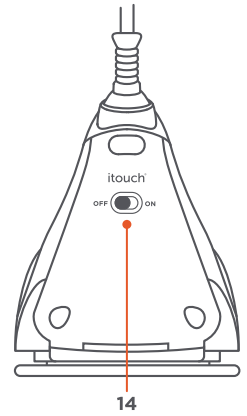





top view



back view



get to know your oliso® smart iron®

 1 spray nozzle	 5 flip funnel™	 9 steam burst	 13 360° pivot cord
 2 detailer tip	 6 water tank	 10 spray mist	 14 itouch® over-ride
 3 soleplate	 7 fabric selector	 11 status light	all features available on models: TG1050 TG1100 TG1250Pro TG1600Pro
 4 scorch guards™	 8 steam selector	 12 itouch® handle	

3 simple steps to start

step 1

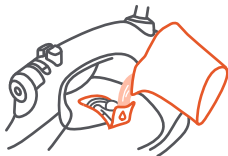

fill unplugged

Open the flip funnel™ and add water to the tank with the fill cup or directly from a faucet.

2 fill cups equal the max capacity of the water tank.

step 2

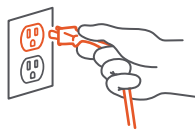

set up

Plug in. Choose a fabric setting then set desired steam level.

step 3

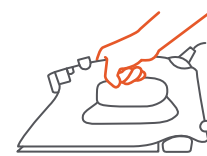

iron

When the green light stops blinking and is solid, the iron is ready for use. Touch the handle and begin using.

itouch® + auto-lift®

activating itouch®

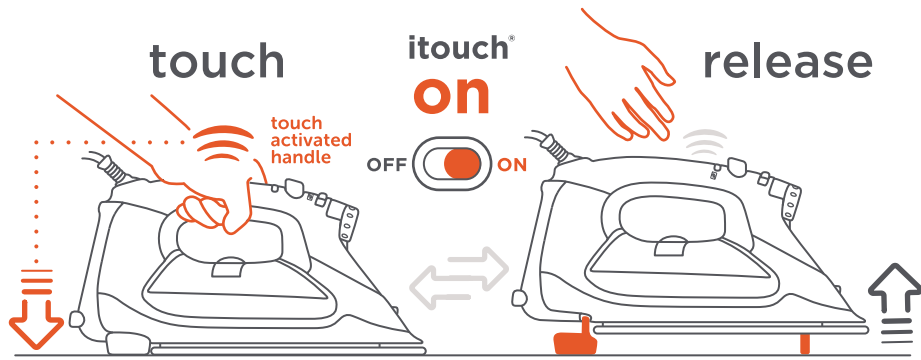

itouch®
your gentle touch
activates the **itouch®**
handle to quickly
lower iron into place



auto-lift®
auto-lift® system
instantly raises iron
up when itouch®
handle is released



deactivating itouch®

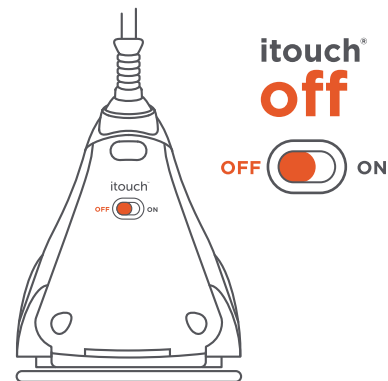

If you wish to deactivate the
itouch® feature, set the switch
on the back of the iron to the
(OFF) position.

The iron will function like a
standard iron. If you wish to
reactivate the itouch® feature,
set the switch back to the
(ON) position.

As a safety precaution, when itouch® is deactivated, if the soleplate is left face down for more than 30 seconds (TG1050, TG1100, TG1250Pro) or 3 minutes (TG1600Pro Model) the scorch guards™ will automatically lift the iron off fabric, preventing scorching and burns.

For more information regarding the auto shut-off safety feature see page 6.

auto shut-off system

iron position

TG1050 | TG1100 | TG1250Pro | TG1600Pro

itouch® on	horizontal lifted	8 minutes	8 minutes	8 minutes	30 minutes
	vertical	8 minutes	8 minutes	8 minutes	30 minutes
	knocked over	30 seconds	30 seconds	30 seconds	30 seconds

itouch® off	Horizontal	30 seconds	30 seconds	30 seconds	3 minutes

scorch guards™ will pop out as a safety feature when turned off.

If the oliso® smart iron® is not being used while it is plugged in, the status light will flash red and the iron will turn itself off.

Simply touch the handle of the iron to restart it.

after ironing

store iron properly

- 1 Turn the fabric selector to off. Slide the steam selector to off (☒).
- 2 Unplug the appliance. (Do not hold iron while unplugging or the scorch guards™ will not stay extended. Iron should always be stored with scorch guards™ extended to prevent leaking).
- 3 Allow to cool thoroughly before storing.
- 4 **Important:** Empty water from the water tank after each use. To do this, open the flip funnel™ and tilt the iron to the left over a water receptacle until the tank is empty.
- 5 For easy storage, the power cord can be wound loosely around the iron once it has cooled.

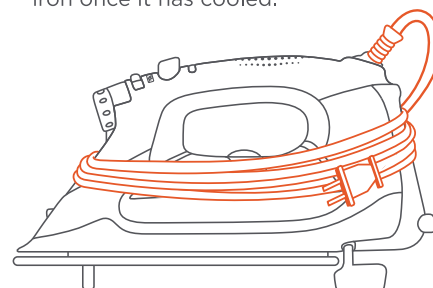

filling water tank

step 1



switch off

unplug iron

step 2



open port

step 3

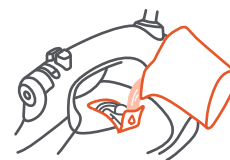

fill (cup included)

Two fill cups equal the max capacity of the water tank.

If you need to add water during ironing, unplug the iron and repeat the above steps. After filling, make sure the iron is fully reheated before ironing.

max fill line

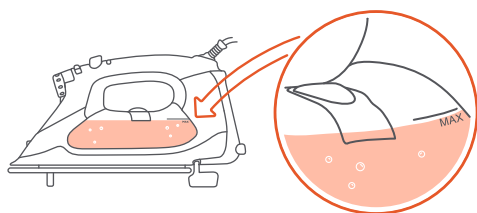

DO NOT

Fill the tank past the **MAX** fill line on the side of the iron. Close the port when done.

alternative filling

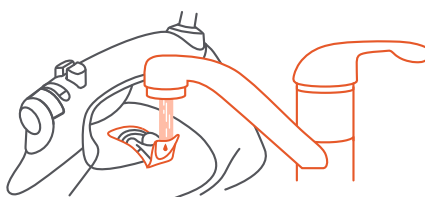

Alternatively, fill directly from a faucet holding the iron horizontally. Make sure iron is unplugged.

water recommendations

This iron is designed to be used with regular tap water. If your water is over 12 grams of hardness, we recommend using either inexpensive bottled spring water or mixing half tap water with half distilled water.

NEVER USE 100% distilled water as this can cause the iron to spit and leak.

fabric selector

fabric selector

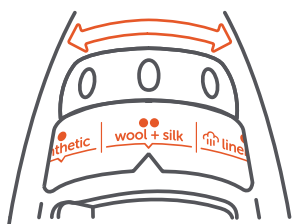

off | synthetic | wool + silk | linen + cotton

dry iron

steam iron

Turn the fabric temperature selector to select a fabric setting. To use continuous steam or steam burst, the temperature must be set to the cotton or linen range.

status light

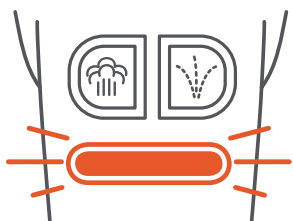

red	flashing green	solid green	flashing red
heat off	optimizing temperature	ready	auto off (heat)

The oliso® smart iron® uses a status light to display the iron's status. To ensure correct temperature, wait until the light displays solid green before ironing.

triple-play™ steam

continuous steam selector

Slide the steam selector to set the amount of continuous steam.



The iron can only produce steam when the fabric selector knob is set to linen + cotton



Allow the iron to heat up (**solid green status light**) before activating the steam control. Steam will be produced as soon as the iron is lowered. Steam will stop when iron lifts up.

horizontal burst

press steam button in



For a strong burst of steam from the soleplate.

vertical steam

press steam button in



Handheld steamer for curtains and hanging clothes.

spray

press spray button in



Helps iron heavy fabrics or difficult areas.

dry ironing

To turn off the steam, slide the steam selector off ().



zero-drip



no drip system

The **oliso® smart iron®** has a zero-drip feature which shuts off steam any time the iron's scorch guards™ are extended.

trouble shooting guide

problem	things to check	solution
Iron does not heat	Is fabric selector set to off?	Turn the fabric selector knob to a fabric setting.
	Is iron plugged in correctly?	Check to make sure the plug is fully plugged into the socket.
	Is auto shut-off system activated?	Touch the handle.
Scorch Guards™ do not come out	Is itouch® switch set to off?	Set the switch on the back of the iron to the ON position.
	Is iron plugged in correctly?	Check to make sure the plug is fully plugged into the socket.
	Is handle activated?	Move your hand away from the iron, and the itouch® technology will raise the soleplate.
Iron does not steam	Is iron hot enough?	The fabric selector must be set to the wool, cotton or linen settings to produce continuous steam.
	Is steam selector set to off?	Steam selector must be turned to a setting.
	Is steam valve clogged?	Move the steam selector from off () to the max () settings a few times to unclog.
Iron leaks	Is itouch® off, and iron is horizontal?	When the itouch® switch is set to OFF, always store the iron in the vertical position. We recommend turning on the itouch® technology to store the iron.
	Is iron is hot enough?	Make sure the fabric selector knob is set to the cotton or linen range to ensure proper steam production.
	Has steam burst button been overused?	Allow 3 seconds between uses of the steam burst function.
Iron is emitting a brown or white substance	Is water hardness too high?	Switch to either spring water or half tap/half distilled water mixture. See water recommendations on page 4

maintenance + cleaning

The soleplate should be cleaned if starch or other residue builds up. When the iron is cool, wipe the soleplate with a soft, damp cloth. Do not use abrasive cleaners or scouring pads as this will damage the iron's soleplate.

Mineral deposits from tap water can occur in the soleplate vents. To clean, fill the water tank and heat the iron to the linen fabric setting. Once the iron is fully heated, unplug the iron and hold over a sink. Press the steam button repeatedly until water begins to drip out of the soleplate. Be careful, as this creates large amounts of steam.

To ensure optimal steam production, the steam valve should be regularly cleared of accumulated debris and minerals. This is done by moving the steam selector back and forth from the off () to the max () steam settings several times.

If problems persist please visit oliso.com/faqs

warranty

REFURBISHED and REMANUFACTURED

Oliso warrants for REFURBISHED & REMANUFACTURED products that for a period of one year (TG1050, TG1100, TG1250Pro, TG1600Pro, Models) from the date of the original purchase, this product will be free from defects in material and workmanship, when utilized for normal household use. Oliso will repair or replace this product or any component of the product found to be defective during the warranty period without charge to the customer. If a replacement product is sent, it will carry the remaining warranty of the original product. Replacement will be made with a new or remanufactured product or component. If the product is no longer available, replacement may be made with a similar product of equal or greater value. This is your exclusive warranty.

This warranty is valid for the original retail purchaser from the date of initial retail purchase and is not transferable. Keep the original sales receipt. Proof of purchase is required to obtain warranty performance. Oliso dealers or retail stores selling oliso products do not have the right to alter, modify or in any way change the terms and conditions of this warranty.

The liability of oliso is limited solely to the cost of repair or replacement of the product at its option. This warranty does not cover normal wear of parts and does not apply to any product that has been tampered with or used for commercial purposes. This warranty does not cover damage caused by misuse, abuse, use on improper voltage or current, use contrary to the operating instructions, negligent handling or damage due to faulty packaging or mishandling in transit. This warranty does not cover damage or defects caused by or resulting from damages from shipping or repairs, service or alteration to the product or any of its parts, which have been performed by a repair person not authorized by oliso. Further, the warranty does not cover Acts of God such as fire, flood, hurricanes, and tornadoes.

This warranty is extended to the original purchaser of the product and excludes all other legal and/or conventional warranties. The responsibility of oliso is limited to the specific obligations expressly assumed by it under the terms of the limited warranty. In no event shall oliso be liable for any incidental or consequential damages caused by breach of any express, implied or statutory warranty or condition.

Except to the extent prohibited by law, any implied warranty or condition of merchantability or fitness for a particular purchase is limited in duration to the duration of the above warranty. oliso disclaims all other warranties, conditions, or representations, express, implied, statutory or otherwise. In no event shall oliso be liable for any indirect, special, incidental or consequential losses or damages (including but not limited to interruption of business or loss of business or profit) resulting from the use of or inability to use the product, any breach of contract, fundamental or otherwise, or for any claim brought against purchaser by any other party. Some states or jurisdictions do not allow the exclusion or limitation of incidental or consequential damages or limitations on how long an implied warranty lasts, so the above limitations or exclusion may not apply to you. If you have any question regarding this warranty or would like to obtain warranty service. Please email oliso at customerservice@oliso.com, and a service center address will be provided to you.

Please note: Your oliso® smart iron® may look slightly different than the irons illustrated here.
For a complete review of current oliso® smart iron® models, please visit oliso.com

For more information visit

oliso.com     

we'd love to hear from you!

8:30am - 4:30pm (Pacific) Monday-Friday 1-800-899-5157
or mail us at 1200 Harbour Way S, STE 215, Richmond, California, 94804, USA.

customerservice@oliso.com

thanks

for purchasing the

oliso[®]
smartiron[®]

reinvented *for you*[™]