

POWER

By ITEMDesign Works

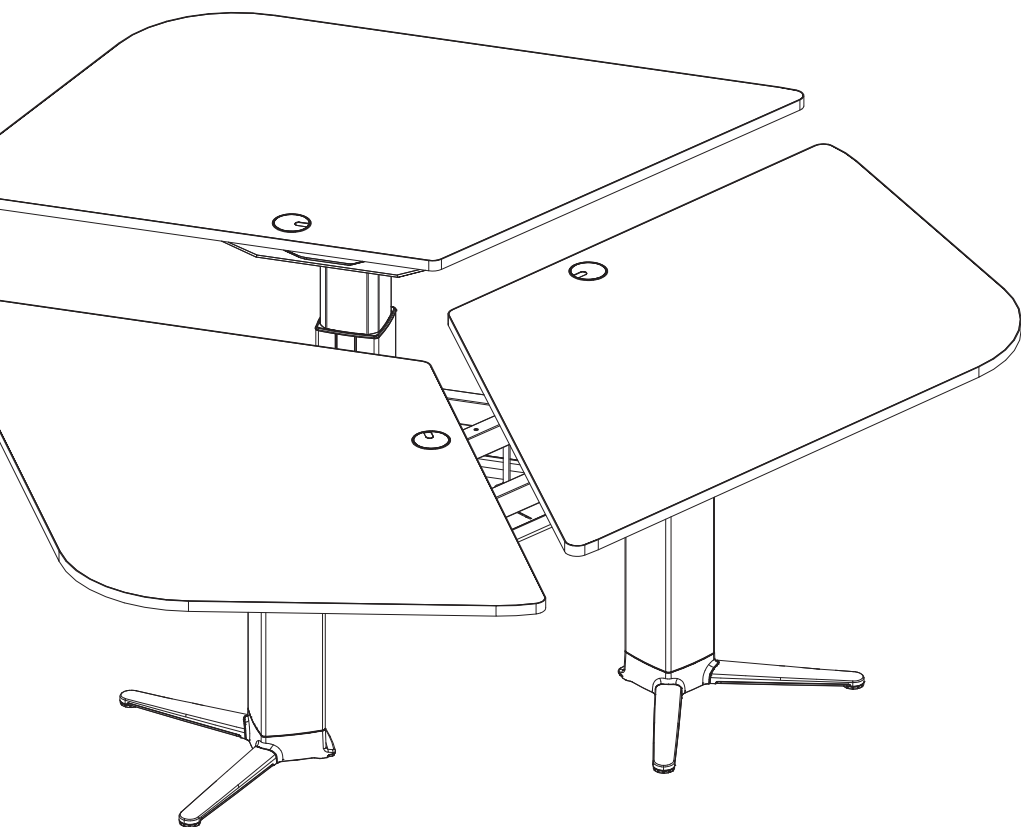

- INSTRUCTION MANUAL
- INSTRUCCIONES PARA EL USO
- BEDIENUNGSANLEITUNG
- INSTRUCTIONS D'UTILISATION





ACTIU BERBEGAL Y FORMAS, S.A. - A03137874
Castalla - Alicante - Spain - European Union

General Instructions	pg. 4
Intended use	
Basic Safety Regulations	
Assembly Site Conditions	pg. 5
Unboxing	
Safety at the Desk	
Operating guidelines	pg. 6
Electric overload	pg. 7
System assembly and connection	
Product Description	pg. 8
References and Measures	pg. 9
Technical Data	pg. 10
Movement Area	
Remote controls	pg. 11
Set up	
RESET procedure	pg. 12
FULL RESET procedure	
Programmable remote control features	pg. 13
Save a height setting	
Switching to a different height setting	
Setting the height limits	pg. 14
Safety Instructions	pg. 15
What do to if there is a fault	
Damage repair	pg. 16
Maximum Weight	pg. 17
Instructions Maintenance	
Care	
Disconnecting the table	pg. 18
Disposal	
Replacement parts	

General Indications

This instruction manual will help you to safely and correctly use your Power desk, while taking full advantage of all its features.

Anyone who uses the Power should read and apply all the steps and instructions that appear in this manual. If the product is not used correctly, the manufacturer shall not be responsible for any claims, nor for any damages that are caused.

Intended Use

The Control Box units must always be used according to general safety guidelines and for their purpose of controlling height-adjustable electric desks. Control boxes must be installed, set up, and checked by specialist personnel.

The desk is not suitable for outdoor use, it should always be used indoors.



Basic Safety Regulations

The desk can be used by children over 12 years old, by people with reduced physical, mental or sensory abilities, as well as by people with little experience and knowledge, provided they are under the supervision of a qualified person or have been provided with the necessary information on how to safely and correctly use the desk in order to understand the possible dangers that may arise from its misuse. Do NOT allow children to play with the desk.

Assembly Site Conditions

Generally speaking, the following measures will guarantee that the furniture can be assembled in a comfortable and ergonomic way:

Straight desks:

- 100 x 100 cm: 260 x 300 cm
- 140 x 85 cm: 300 x 285 cm
- 160 x 85 cm: 320 x 285 cm

Twin desks:

- 140 x 175 cm: 300 x 375 cm
- 160 x 175 cm: 320 x 375 cm

Management and meeting desks:

- 100 x 180 cm: 260 x 380 cm
- 140 x 140 cm: 300 x 340 cm

Triple desk - GEN

- 238 x 223 cm: 400 x 420 cm

- Room temperature between 5-30°C
- Atmosphere without risk of explosion
- Do not assemble under a window

Unboxing

All electrical components are packaged in a cardboard box, some components are also wrapped in plastic film. Follow these steps to unpack:

- Remove the cardboard and plastic sheets from all components.
- Check the contents of the package.
- Discard all packing materials.
- Keep the instruction guide close at hand.

Safety at the Desk

Avoid the risk of crushing people and objects:

- Do not place any object underneath or on top of the desk when adjusting its height.
- Pay attention to other people who are close to the desk.
- Before connecting the control box to the power supply you must check that the mains voltage is the same as that of the control box.

Operating guidelines



Warning: This symbol indicates danger for people. Not following this warning may lead to health problems.



Warning: Do not open the compact control box under any circumstances. In doing so you may suffer an electric shock and invalidate the guarantee.



Warning: The compact control box must only be connected to the same voltage as indicated on the specifications sticker.



Warning: Only use the power cable supplied with the control box. Do not use the control box if the power cable is damaged.



Warning: Before connecting and disconnecting any device, you must ensure that the power cable is not connected to the power supply.



Warning: Do not expose the compact control box to humidity, dripping water, or splashes.



Warning: When changing the position of the table top, there is a risk of accident and trapping. Therefore, ensure that the danger area is clear of people and objects.



Warning: Only use original replacement parts. Said parts can only be replaced by qualified personnel. In the event of product faults, please contact Actiu customer service.



Information: Use only a dry cloth to clean the compact control box. Make sure the power cable is disconnected before cleaning.

Electric overload



Warning

To avoid injury and damage to materials caused by electric overload:

- Disconnect from the power supply when assembling, disassembling, and performing maintenance.
- Disconnect from the power supply if you notice smoke or strange odours or noises.
- Disconnect from the power supply during storms and when not in use for extended periods of time.
- Ensure liquids do not enter sockets.
- Do not use the desk if the power cable shows signs of damage.
- In this case, the power cable will need to be replaced by qualified personnel from Actiu's technical service.

System assembly and connection

- a Compact control box
- b Electric legs
- c Height remote control
- d Power cable

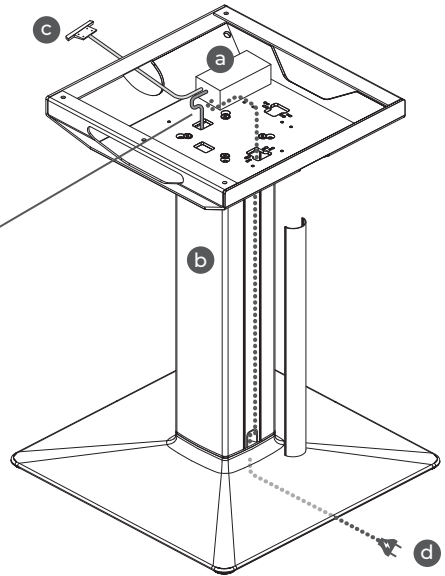
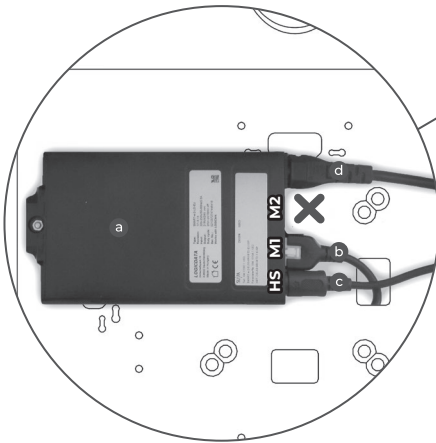

Product Description / Serie 100

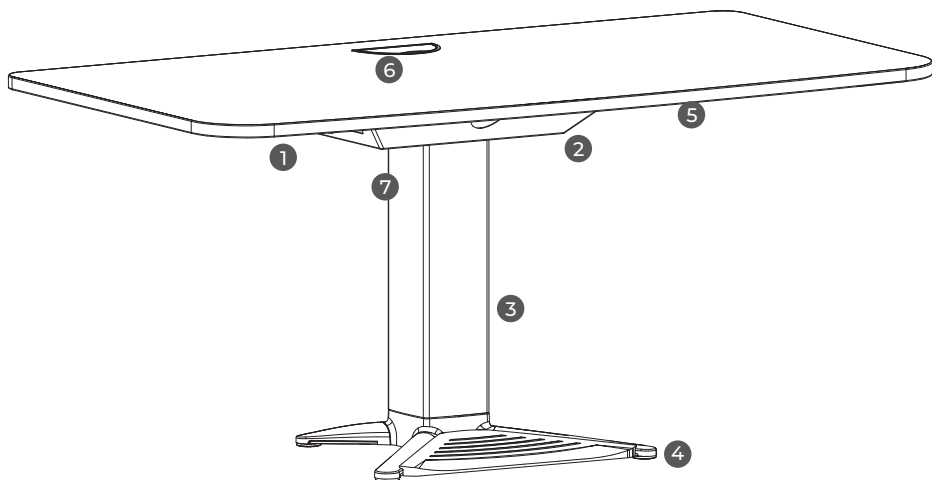

- 1 **Structure** realized in melamine board of 25/30 mm of thickness, like support of the work surface.
- 2 **Lower container** made of 6 mm-thick steel sheet, with a large capacity for cable accesses.
- 3 **Column:**
Electronic Elevation Desks: Adjustable steel tube leg composed of one 137 x 137 mm section, plus a 150 x 150 mm extruded aluminium cover.
- 4 **Base** with four 610 x 506 mm cross supports in individual and double desks, 610 x 400 mm in triple desks and 610 x 610 mm in meeting and videoconference tables, made of die-cast aluminium. Levellers made of PP.
- 5 **Work Surface**, made of 25 mm melamine with 2 mm thick edges, applied with hot melt adhesive and rounded to R = 2 mm or 13 mm phenolic. Rounded corners. Different finishes.
- 6 **Cable accesses**, with a semicircular shape, made of die-cast aluminium. Flip-up cover.
- 7 **Silent Block**. System that minimize the noise of lifting of the table.

Product Description / Serie 300

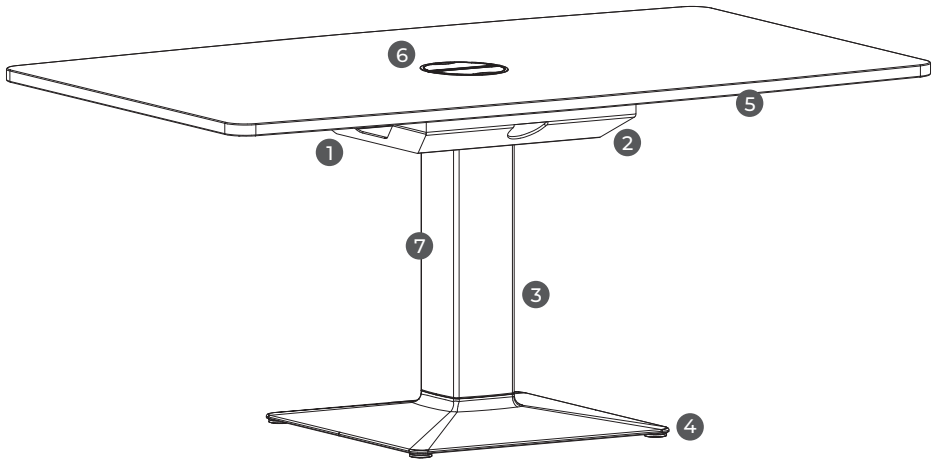

- ① **Structure** realized in melamine board of 25/30 mm of thickness, like support of the work surface.
- ② **Lower container** made of 6 mm-thick steel sheet, with a large capacity for cable accesses.
- ③ **Column:**
Electronic Elevation Desks: Adjustable steel tube leg composed of one 137 x 137 mm section, plus a 150 x 150 mm extruded aluminium cover.
- ④ **Base:** 610 x 610 mm square base, made of die-cast aluminium. Levellers made of PP. It include counterweight for greater stability.
- ⑤ **Work Surface**, made of 25 mm melamine with 2 mm thick edges, applied with hot melt adhesive and rounded to R = 2 mm; 13 mm phenolic or 10 mm crystal. Rounded corners. Different finishes.
- ⑥ **Cable accesses**, with a semicircular shape, made of die-cast aluminium. Flip-up cover.
- ⑦ **Silent Block.** System that minimize the noise of lifting of the table.

References and measures (cm)

Serie 100

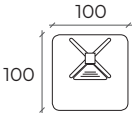
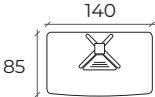
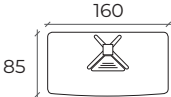
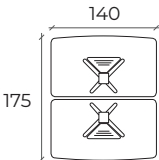
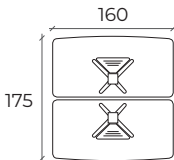
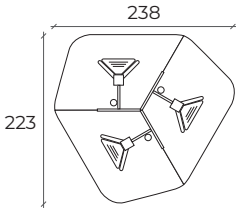
References	PV10N	PV13N	PV14N
Measures			
References	PV83N	PV84N	
Measures			
References	PV33N		
Measures			

Serie 300

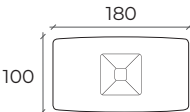
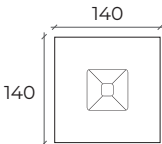
References	PV19N	PV43N	
Measures			

Technical data

Supply voltage	Eu: 207-254,4V / 50Hz Us: 90-127V / 50-60 Hz
Standby power consumption	< 0,6 W
Performance	83% @ 300W Supply input
Motor measuring accuracy @ 100% Output 4-8A per motor	± 20%
Room temperature	0°-30° C
Operative relative humidity	5-85% (non-condensing)
Transport and storage temperature	-40° - 85° C
Storage relative humidity	5 - 90% (non-condensing)
Type of ground wire protection	
Power cable length	3 meters ± 50 mm

Movement area

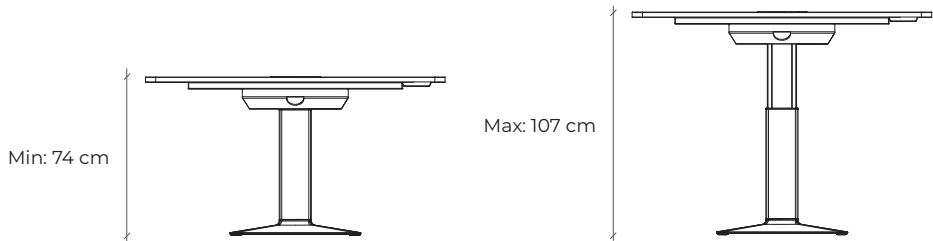

Remote controls

Programmable remote control

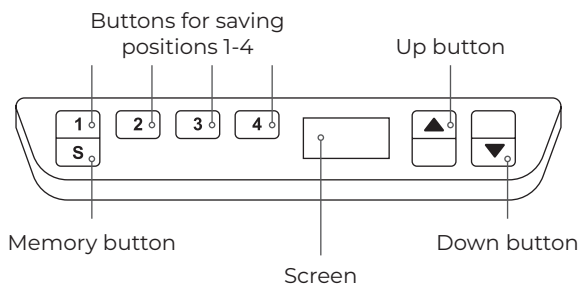



Set up

Our first step in setting up an electric height-adjustable table is a **RESET** of the electronic controls.

If the screen intermittently displays "000" a **RESET** is needed.

The desk may vibrate slightly in the first few uses. This will self-correct.

RESET procedure

- 1°  Hold down the **DOWN/LOWER ARROW** button until the desk reaches **the lowest position**. Release the button.
- 2°  Press and **hold down the DOWN/LOWER ARROW** button again. After 5 seconds, the desk will slowly lower again until it reaches the absolute lowest position.
- 3°  **Release the DOWN/LOWER ARROW button**. The height-adjustable desk may now be used normally.









Instructions video



actiu.com/mobility-reset



FULL RESET procedure

If the desk reset does not work correctly, a **FULL RESET** of the control box must be performed. This will restore the factory settings and delete any saved settings by user. This option is only available on the **PROGRAMMABLE REMOTE CONTROL**.

- 1°    Press and hold down the memory 1 and 2 buttons and the up/raise arrow together for 5 seconds.
- 2°  The display will show "S" and a number. For example "S3".
- 3° Release the buttons.
- 4°  Press the **UP/RAISE ARROW** button until the display shows "S 0"

- 5°  Press the **MEMORY** button
- 6°  Several "clicks" will be heard and E61 will appear on the display.





- 7°  Wait a few moments until 000 flashes on the display.
- 8°  Press **DOWN/LOWER ARROW** until the table reaches its minimum height, the height will then appear on the display.

NOTE: While the display is flashing the digits 000, the table can only be lowered slowly.

Programmable remote control features

Save a height setting

For example, imagine we want memory position 1 to be 73cm in height:

- 1°  Press the UP/RAISE ARROW or the DOWN/LOWER ARROW until the digital screen displays 73.
- 
- 2°  Push the key “S” and then the key “1”; you will hear two clicks and the 73cm height will be stored as key no.1. The same procedure is used for setting the other 3 heights for keys 2, 3, and 4.
- 

Switching to a different height setting

There are one way to switch between the previously saved desk height settings:



- 1°  If we hold down the corresponding memory key, for example, button “1”, the desk will rise or lower to the saved height and stop there, even if we continue to press the button.

Setting the height limits





The desk features a height limit function for both the maximum and minimum heights. These limits are used to avoid hitting shelves or furniture at a lower height.

LOWER LIMIT

- 1°  Lower the desk to the safety position, then press and hold the “S” button for ten seconds. A double click will confirm that the lower limit has been set correctly.
- 2°  To remove it press the down/lower button until the desk reaches the position and hold the “S” button for ten seconds. A double click will confirm that the lower limit has been removed.

UPPER LIMIT

- 1°  Raise the desk to the safety position, then press and hold the “S” button for ten seconds. A double click will confirm that the upper limit has been set correctly.
- 2°  To remove it press the up/raise button until the desk reaches the position and hold the “S” button for ten seconds. A double click will confirm that the upper limit has been removed.

What do to if there is a fault

In the event of a fault, such as, for example, the motors being blocked, do not use the desk and contact your Actiu distributor.

Damage repair

Indication	Cause	Solution
HOT	Overheating has caused the control box to stop working	Wait 18 minutes until the control box has cooled down and stops displaying the message
E12	Leg defect	1st Disconnect the main power cable 2nd Check connections and reconnect
E24	Overuse motor leg	1st Disconnect the main power cable. 2nd Remove excess weight from the leg. 3rd Remove any object blocking movement
E36	Motor disconnected from the control box	1st Disconnect from the power supply and wait 5 seconds 2nd Connect to the power supply 3rd Check the power cables and readjust 4th RESET
E37		
E38		
E67	Power surge, incorrect voltage	Disconnect the main power cable

If you are unable to clear the error message, disconnect the desk from the power supply, wait a few minutes, and try **RESETTING** the desk.
If the error occurs again, disconnect the desk from the power supply and contact Actiu.

Safety Instructions

- Do not sit on the desk.
- Do not use the desk as a forklift.
- Do not raise the desk while objects are on the desktop.
- Do not place objects close to the desk when changing the height.
- Warning: this is a height-adjustable desk and objects placed on the desktop may fall off when adjusting the height.
- Make sure you have a safe, wide space, free of objects to ensure generally easy, ergonomic, and safe raising of the desk.

Maximum weight

Power table can bear a vertical load up to 60 kg. The aforesaid load should be exerted on the column and centre of gravity of the table. Power table is a mobile table, therefore it is advisable not to move the table when there is load on top of it.

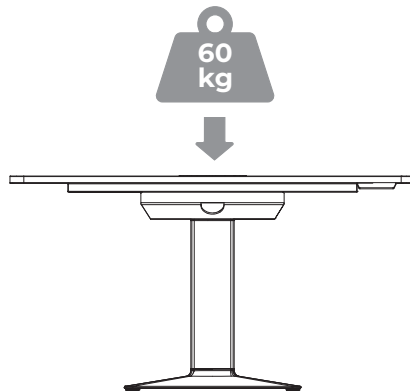

Maintenance Instructions

The Power desk does not require any type of maintenance

Care

Clean off any dust and dirt from the surface periodically with a mild cleaning product that has a neutral pH.

If the product is not used correctly, the manufacturer shall not be liable for any claims.

Disconnecting the table

To turn the table off, disconnect the power cable from the power supply.

To disassemble the desk, please check the assembly guide and follow the steps therein in reverse order.

Disposal

Electronic parts and components must be disposed of at an electronics recycling collection point.

All other components must be disposed off in accordance with the corresponding local waste management laws. Please contact your Actiu distributor for more information.

Replacement parts

Please contact your Actiu distributor.