

HermanMiller
Imagine Desking System™





Introduction

Imagine is a flexible, high-quality desking system that addresses a broad range of workplace needs across the floorplate. Whether you're looking for deeper team collaboration, a boost in creativity, or increased focus, Imagine is the backbone of the settings that help people do their best work, naturally.



Design Story

Designed for maximum versatility and ease of deployment, the Imagine Desking System has a universal infrastructure and interchangeable components. Imagine is designed to accommodate the changing nature of work from variable work style, shifting needs for privacy, and the growth of the company, all with the same kit of parts. And, thanks to that same smart design approach, specifying, ordering, and installation go smoothly.



Flex as Needs Change

Imagine gives organizations the freedom to create different kinds of workspaces as needs and preferences change. Options include benching, desks, 90-degree and 120-degree workstations, and meeting tables. Screens (suspended and floor-standing) create more or less privacy for teams and individuals, and come in tempered glass, printable fabric, perforated metal, and wood-base panels. Structured extensions and single and double returns accommodate organizations as they grow.

Imagine has three styles of legs, allowing organizations to express their character through design. The Tech leg has a unique triangular fold that creates a shifting profile when viewed from different angles. The Capsule leg with its “loop” design adds an architectural flair to any space. And the angled Axis leg, inspired by the way two divergent ideas can spark a new direction, are an expression of creativity.



Imagine Conference Table

Keep It Simple

All Imagine's elements fit and work together, making it easy to change up the settings in and accommodate different work styles. That kit-of-parts design results in a more streamlined specification and ordering process and rapid installation.

In addition, Imagine's cable management makes it easy to access and conceal wires. Work surfaces are designed with flip accessed options for easy above-desk power access. There's also a work surface option designed with a gap for attaching monitor arm supports.







Value, Guaranteed

Sturdy and durable, Imagine performs over the long haul. And because it can be reconfigured to create different settings, Imagine can have multiple lives in a company, providing more options for the investment.



Design for the Environment

For the latest information on Imagine Desking System's sustainable elements, visit hermanmiller.com/en_apc/imagine.

Details



Screen connector



Linear connector



T-Connector



Cable trays enable power and data cable to be laid-in easily



Tech leg (middle leg) with cover for cable management



Power access on the meeting table worktop

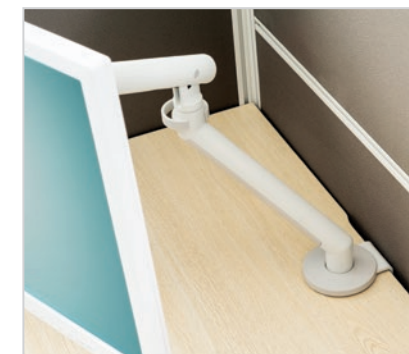

Work surface with flip accessed options



Tech leg integrated with infill

Statement of Line



Rectangular Worktop
Side to Side / Back to Back

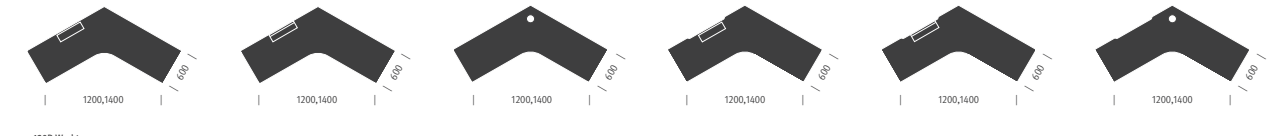
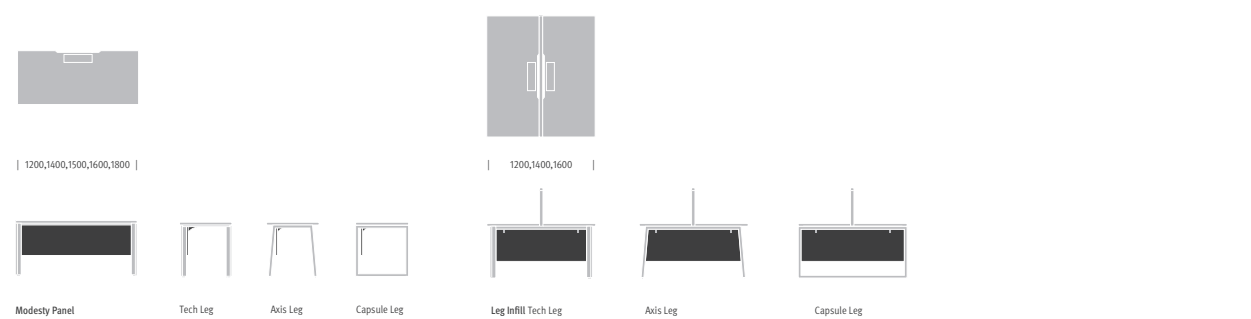
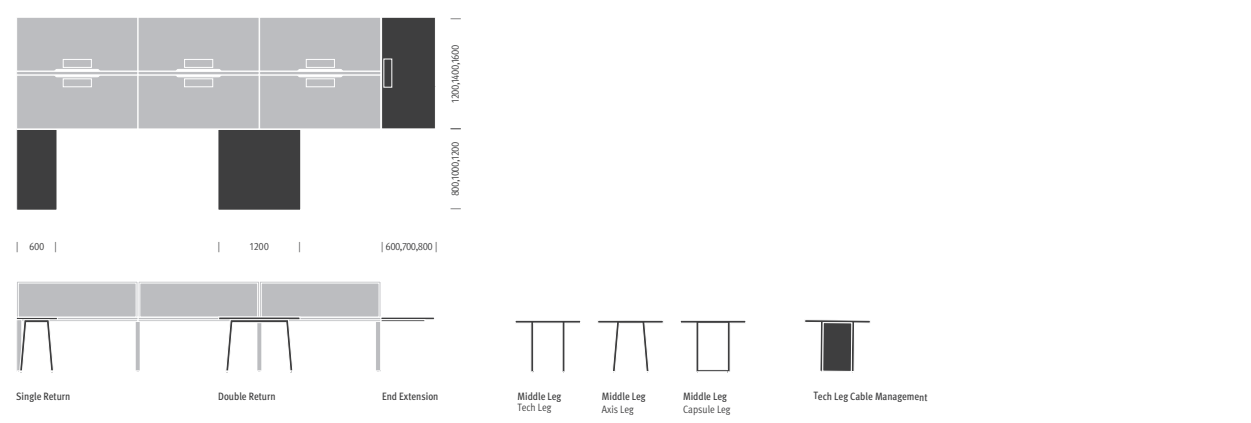
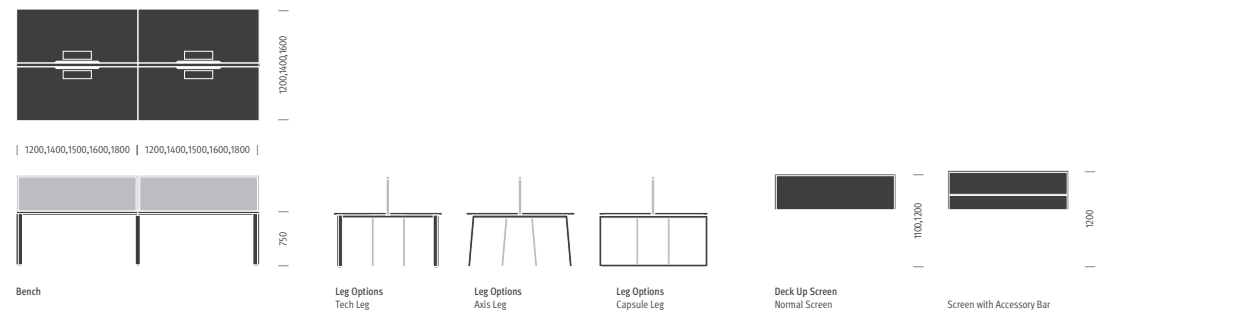
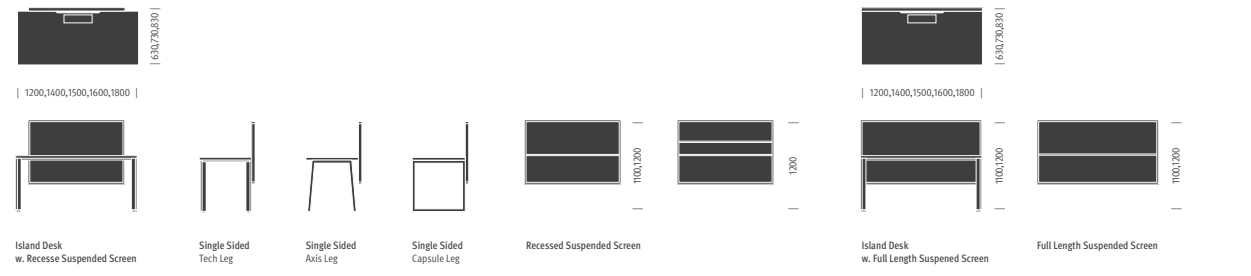
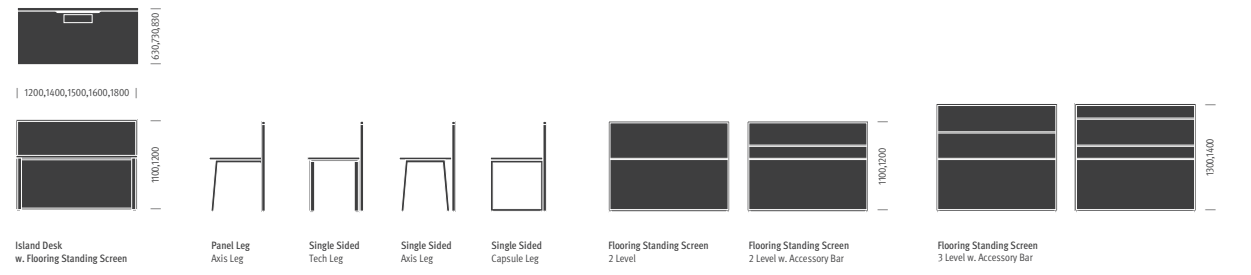

120D Worktop

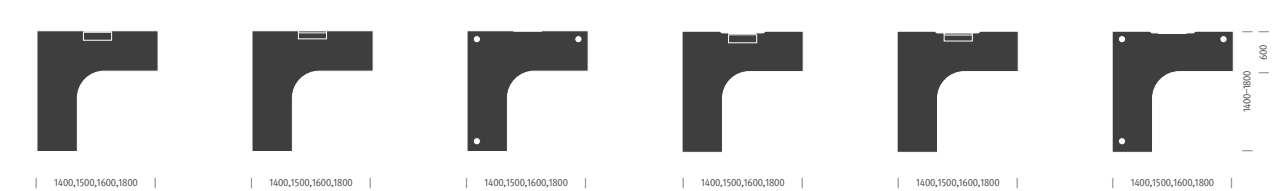
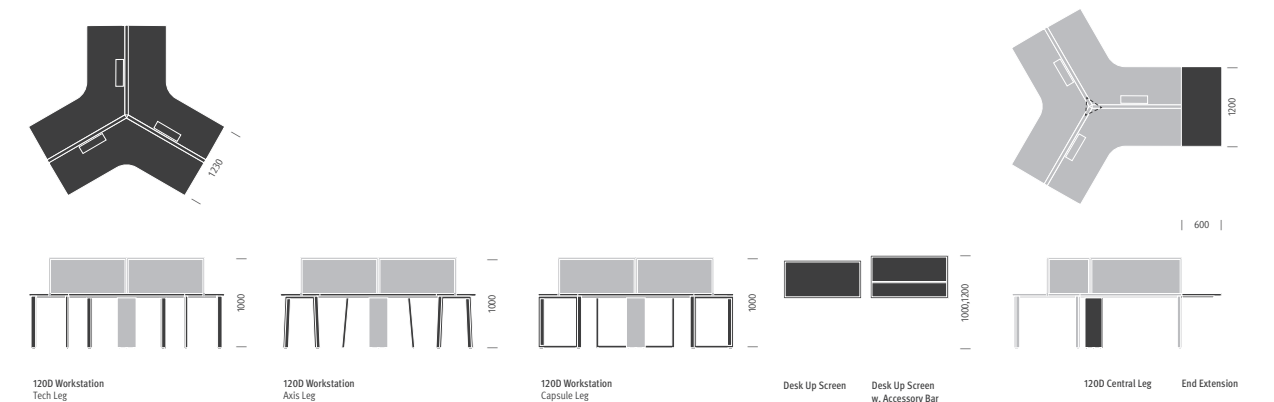

90D Worktop

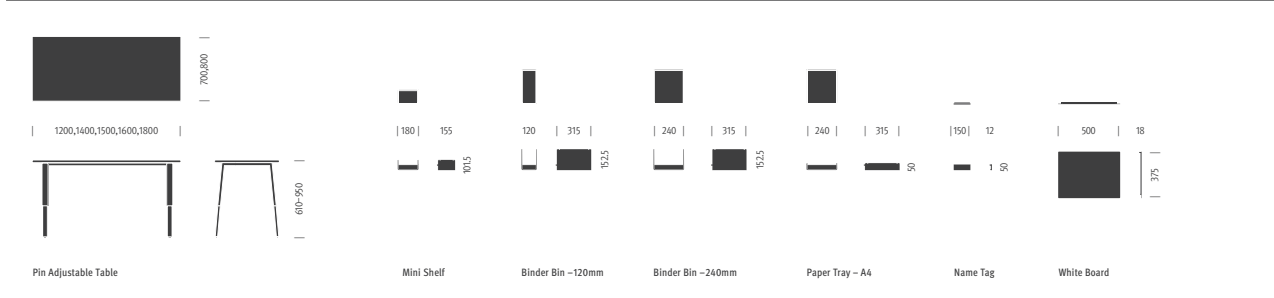
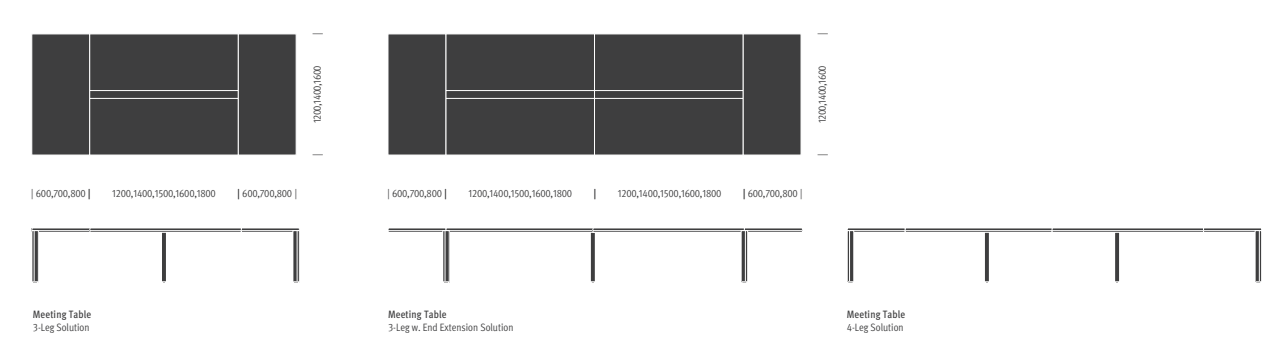
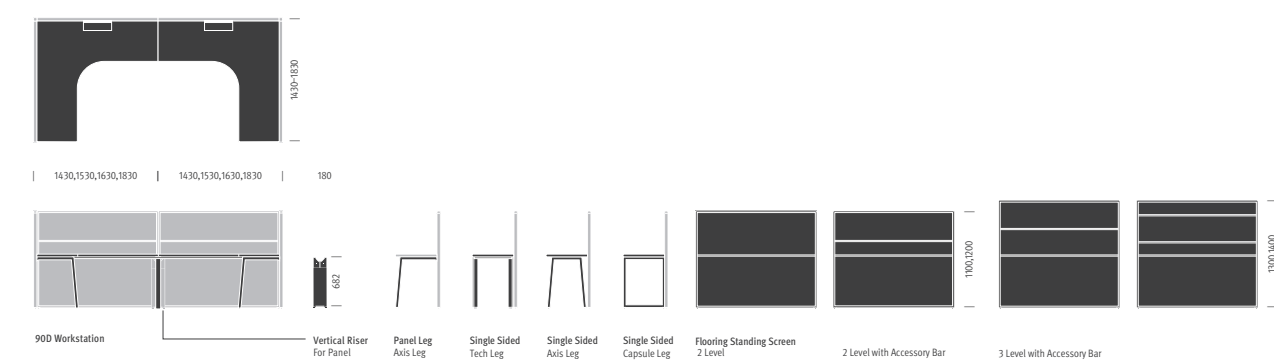

Materials

Imagine is available in a variety of finishes for fabrics, surfaces and frames, enabling you to customize and personalize your look.

Finish

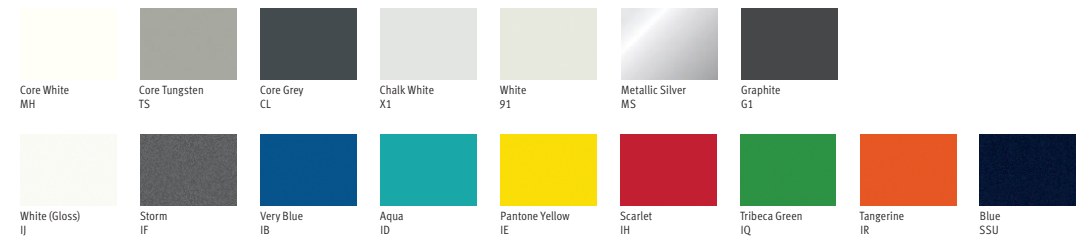

Laminate

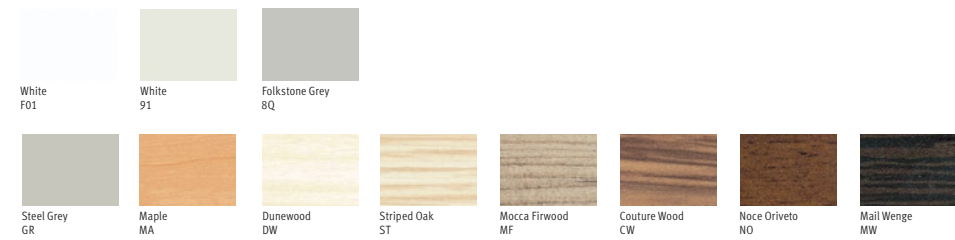

Melamine

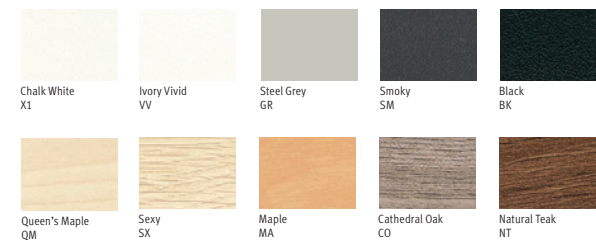

Screen Yodex X



Zen

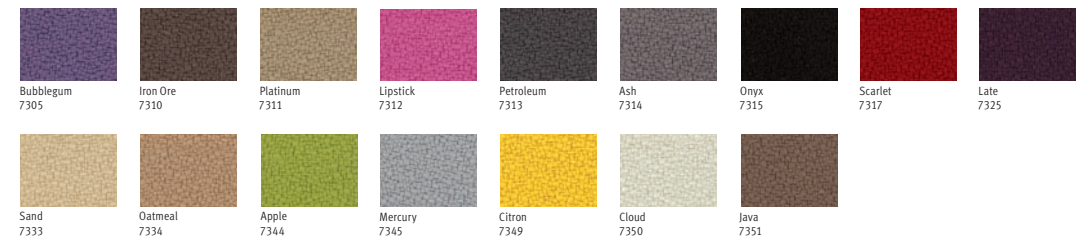

Cosmo

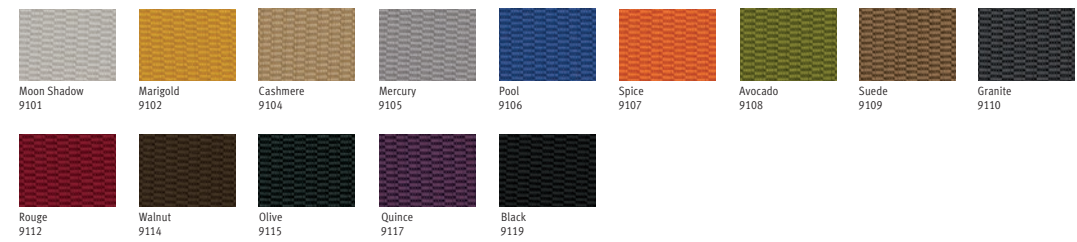

Centurion

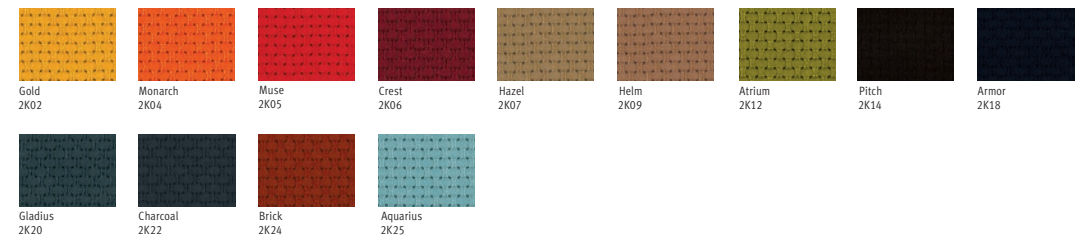

Ripple

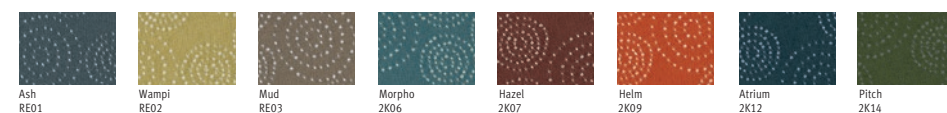

Flax



For more information, please visit hermanmiller.com/asia

HermanMiller and are among the registered trademarks of Herman Miller, Inc. Imagine Desking System is the trademark of Herman Miller, Inc.

Printed in the PRC. Please recycle.
© 2018 Herman Miller Asia Pacific
All rights reserved.

