

# Framery Magazine



# Table of contents

## FRAMERY ONE

**3**

Soundproof like Framery.  
Futureproof like no other.  
Framery One.

**5**

Design story - Framery One

## REFERENCES & ARTICLES

**9**

Reference Case:  
Postmates

**11**

Reference Case:  
Tampere Children's Hospital

**13**

Expert content: Lifecycle costs:  
Conference rooms vs. Framery pods

## FRAMERY PRODUCT FAMILY

**19**

Framery One

**23**

Framery O

**27**

Framery Q

**31**

Framery 2Q

**36**

Product safety

**37**

Taking care of you  
(And your Framery pod)

**39**

Dedicated to sustainability

**41**

The story of Framery

# Serious about happiness



Our products including pods, phone booths and soundproof private spaces solve noise and privacy issues in open offices, making employees happier and more productive in dozens of the world's leading companies, including Microsoft, Puma and Tesla. In fact, 40% of all Forbes 100 companies use Framery.

**Let's make a happy workplace the new normal – together.**

# Soundproof like Framery. Futureproof like no other. Framery One.



Meet Framery One, our first connected soundproof pod. Framery One is not only stylish and super smart, it incorporates the latest technology, leading sound insulation standards and echo-free acoustics. You can look forward to a highly adaptable workspace where you won't be disturbed by outside noise or distractions and can enjoy best-in-class design while you focus on your next project.

## High standards, as standard

We don't like to brag, but we're proud of Framery One's top rating in the new ISO 23351-1 standard for sound insulation. We've taken impressive precautions to reduce speech that could be overheard outside the pod. This means you never have to worry about private conversations being overheard, or disturbing your co-workers, even if the pods are placed near open-plan desks. The pod's impressive ventilation will keep you feeling fresh and focused, while you enjoy the high air quality. And when we say impressive, we mean it. The ventilation speed for Framery One is 29 liters/second – that's over four times higher than recommended for occupied spaces.

## Smart settings

In Framery One, the pod's settings and adjustments are just a swipe away. Want to dim the lighting or adjust the airflow? You can manage the booth using the high-res touchscreen and seamless UI. The occupancy light lets people outside know whether the pod is reserved or free to use. You can integrate the pod with your calendar system so reservations can be made easily, or, if the pod is free, simply step inside and it will be reserved automatically. The UI will show an on-screen message to alert you when your booked slot is nearly up. Feel like you need more time? If no other bookings are coming up, the pod will automatically extend your session so you can continue working without interruption.

## Connect to manage them all

Behind the scenes, our digital management system, Framery Connect keeps the Framery One performing perfectly and alerts you to any potential issues. It's easy to learn what you can do to keep everything running smoothly, while automatic alerts for any maintenance needs ensure that any issues are solved quickly thanks to direct access to Framery. If any issues arise, our premium customer care support will come to the rescue, and can be accessed over email or phone with lightning fast responses. To further put your mind at ease, there's a pod guarantee for your entire subscription, covering parts and a wear and tear policy. Framery Connect also provides insights so you can keep tabs on how Framery One is being used, including details about the booth's utilization rate and return on investment. This makes it easy to see when your office needs more pods.



## Perfect for you

How do you work best? The beautiful Framery One is ideal for one person to produce exceptional work, without distractions. Both the seat and generous table (ranging from 70-120cm/27.6-47.2in in height) are designed to be easy to adjust, with footrests on the floor and fixed to the seat to keep you comfortable for long stretches. If you work best on your feet, there's also the option to incorporate a standing desk.

## Designed for today; built to last

Framery One's impressive exterior comes in a range of Framery colors, while our design team have created a range of interior panel fabrics, carpet, seats and tables, so you can adapt the to suit your company style. And – if you need a super flexible solution – just add wheels. Framery One's future proofed, modular design means that sections of your pod can easily be upgraded as new tech specifications or ways of working become the norm. Your safety is of utmost importance, which is why we use steel as our core material, ensuring the structure is fireproof. Sustainability is also key. In fact, 95% of the material used in the highly durable pod can be recycled. And, just like its users, Framery One will continually improve over time, thanks to software updates that will future-proof it for many years.



# Design story – Framery One



## We Had a Dream – Designing the First Futureproof Pod

It all started with the dream of designing a revolutionary digital and soundproof space that would fulfill all of Framery’s and its customers’ wishes and needs built up over the years. The design was intended to not only reflect current workplace trends, but also those of the future – as well as stand out from the other products on the market. The product had to highlight Framery’s distinguished design and uphold the brand’s qualities – from the unique

experience of the pod’s usability and superior acoustics to the quality and appealing aesthetics – to creating customer happiness!

The end result is a top-of-the-line futureproof pod combining 4G technology and a digital ecosystem with superior acoustics and Framery’s distinguished design DNA.

As future forward and technical as the design team desired the product to be, Framery also wanted to ensure it was comfortable, cozy, and compelling. Using in-depth customer experience research and development,

Framery sought to create a new industry standard with world class quality and lead times.

“The carefully selected production technology used for Framery One enables mass production and full freedom with its design. Using deep drawn sheet metal allows us to modify the product exactly how we wish,” says **Henrik Ashorn, Product Manager** for Framery One. “From the start, the deep drawn sheet metal molds are refined and ready to produce the best possible quality. This would not be possible with traditional production methods!”

## What Was the Market Missing?

During the design process, Framery strived to create a never-before-seen product – or actually a whole new product category. Studies show that phone calls in the workplace have decreased while the number of video calls is simply exploding. Framery wanted to design a “2020” pod that will meet the work-life and workspace needs for the next decade and beyond. With its efficient design, Framery One gives users the maximum amount of space while it occupies as little of the office as possible.

The idea was that Framery One would be soundproof like Framery, and futureproof like no other. Through hundreds of measurements by the in-house acoustic lab, Framery One is guaranteed to provide an acoustically pleasant and private environment for the user. This attention to detail is what makes Framery One a stand-out product. The interiors of Framery One are far more optimized and variable compared to other single-person pods on the market. The comfortable seat and the adjustable table enable flexible conditions while working in the pod. Also, the optimal distance to the screen and the lighting adjustments serve the user better.

It’s now possible to manufacture more pods and scale the volumes,

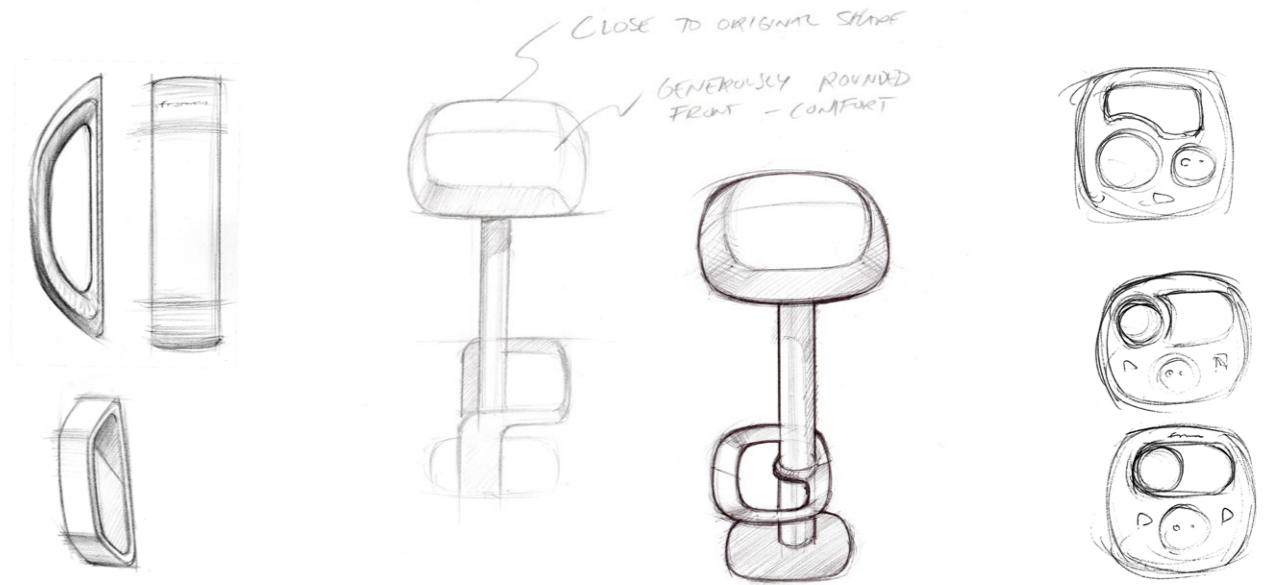

materials, and techniques, all without compromising the quality or refined end result. The choice to use sheet metal on the exterior creates a visually interesting pod that adds a level of sophistication to any space. Design and functionality have literally walked hand-in-hand throughout the entire design process.

## Design DNA

The arch design became the DNA of Framery One’s design. It results in a harmonious environment where everything fits together with ease.

**“It looks fascinating from the outside – and feels amazing from the inside!”**

Holding onto the signature Framery style, the pod needed to look and feel on brand, but have a more modern aesthetic. Using automobile design as a driving inspiration behind its creation, Framery approached the concept not only from how it would look, but also what it would feel like to the users inside. Taking inspiration from Scandinavian architectural design, the organic round arches, glass on both sides of the pod, and a fixed but height adjustable seat provide a more polished version of Framery’s signature style. It was clear from the beginning of the ideation process that the brand’s design staple needed to be preserved but enhanced to create an eye-catching aesthetic. Each piece inside

was customized to fit into Framery One and it is no coincidence that the coat rack, table, screen, and even the smallest pieces that make up the pod also have the same fine-tuned arch shape.

The interest in the end users’ experience as well as production efficiency have been the guiding factors throughout the entire project. November 2019 user tests can be seen as a game-changer in Framery One’s design process. Based on the users’ experiences after working for hours in the pod, it became apparent there were many things that still needed to be fine-tuned.

Framery One needed more adjustability to serve the wide range of shapes and sizes of the user population, as well as allow people to make adjustments that support posture changes and movement throughout the day. For example, previously there was only a single footrest on the seat. However, after further testing and trying a variety of options, another footrest was added to the floor to improve ergonomic alignment and comfort. Adjusting the location of the table and seat towards the back wall improved the overall sense of space as well as the user’s experience.

“Excellent design is not only thinking about how it looks but how it works and feels for the user. It also proves the value of user tests to validate its function.” ▶

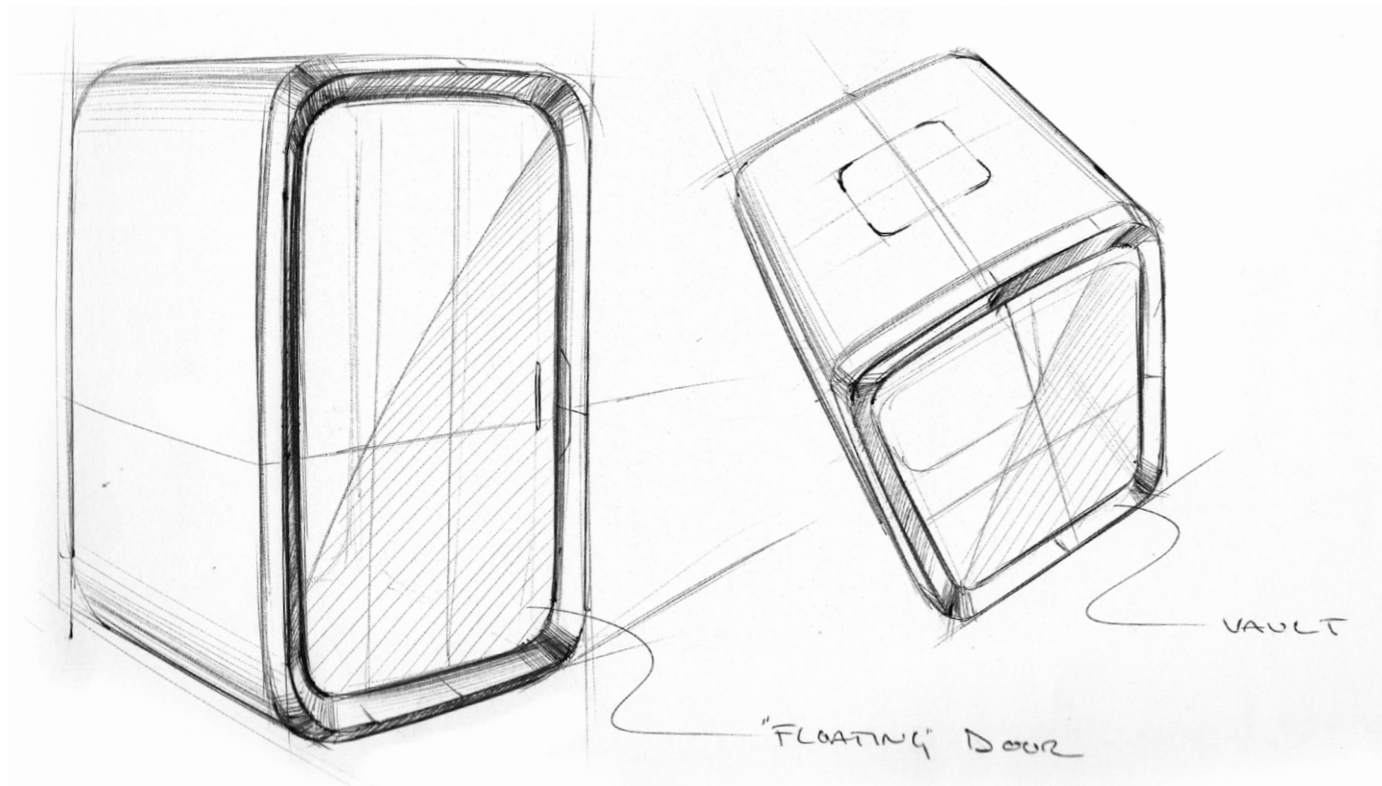

## Framery One's Sleek, Sophisticated & Subdued Color Scheme

In March 2020, the design team wanted to refine the selected color scheme to perfection so that the shades complement one another. Without overlooking even the smallest of design details, every single piece needed to match seamlessly together and within the whole design. After months of selecting the pod colors, materials, and finishes, Framery's design team did some serious brainstorming in a workshop about the final color shades and material finishes, finetuning them to hit the bullseye.

Every detail was carefully selected, including the structure and degree of shine and matte in each part and how they work together. Despite tight schedules, the design team committed to investing the time necessary to scrutinize and refine the materials and finish selections to reach the desired outcome - one that the team is proud of. Design professionals are acutely aware that colors can positively contribute to happiness, productivity and even physical health and well-being in a workplace. Framery One's more subdued color scale offers users a calming experience. Taking a closer look at the pod makes one quickly realize there is not one screw visible - the design is seamless and holistic. The clean lines and sleek finishes complement the pod's sophisticated, calming color options.



## A Futureproof Pod Means Standing the Test of Time

Even though going digital has been a dream for Framery for a long time, getting Framery One to the point of such technological innovation was a challenging process. While working to improve the user panel to adjust the pod functions in late 2019, the team realized that NOW was the time to create a whole new digital ecosystem around pods to serve users, facility managers, and pod maintenance. Furthermore, customer interviews made it clear that fleet management and predictive maintenance would be important for all of the customers, enabling Framery to fix things automatically if something is not working properly. So Framery Connect was designed. A digital management system, which shows usage data, offers a direct access to Framery customer care with lightning-fast maintenance service and offers the pod guarantee for (your) entire subscription.

With the future in mind, the design team wanted Framery One to stand the "test of time." The team developed the product's functionality backed by top notch technology that works in conjunction with the existing features. Framery One is the first digital pod in the world! Equipped with a whole new user experience, Framery One creates a virtual ecosystem around each pod. With the pod's interface panel, the user has an intuitive touchpoint, allowing for control over airflow and lighting, and providing a view to the pod's reservation calendar. The pod itself can be reserved through users own calendar - or just by walking in!

**"Framery One is physically and digitally our dream come true. Nobody knows what the digital ecosystem will enable in the future and we have only just scratched the surface."**

One is based on both expertise and intuition of the design team, making it ready to stand the test of time. The design team wanted to refine the selected color scheme to perfection so that they complement one another. Every detail was carefully selected, including the structure and degree of shine and matte in each part and how they work together.

Design professionals are acutely aware that colors can positively contribute to happiness, productivity and even physical health and well being in a workplace. Framery One's more subdued color scale offers users a calming experience. Taking a closer look at the pod makes one

quickly realize how seamless and holistic the design is. The clean lines and sleek finishes complement the pod's sophisticated, calming color options

## At Long Last, Meet Our Smart Dream Pod

Out of this in-depth design process, Framery One has come to life. A high performing, single-person pod that offers the perfect environment for user productivity and comfort. And, maybe most importantly, provides happiness to all in the office. **We just can't wait for you to meet Framery One!**

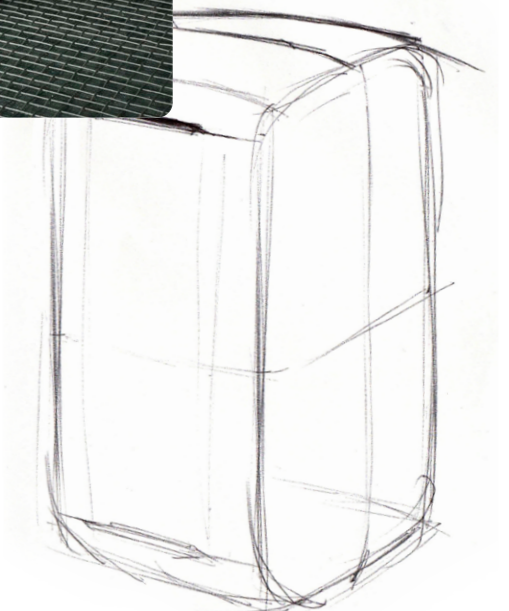
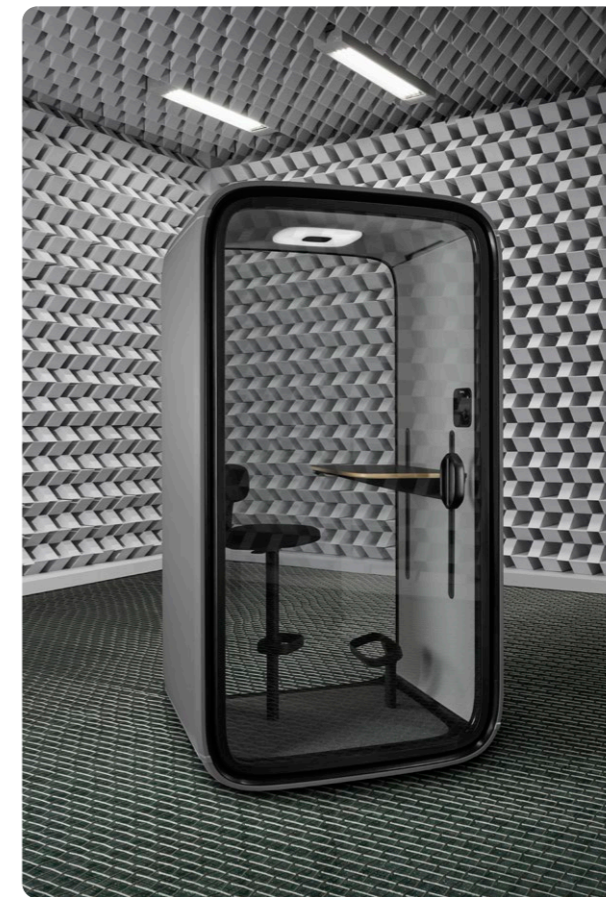

# Postmates



## Improving employee happiness with additional workspaces

“We have noted employees have been using the pods to offset environmental fatigue, as we have an open office layout, and so the booths have become a safe haven for focused work!” tells Wu. This realization has allowed Wu and her team to adjust and design additional workspaces that guarantee concentration, improving employees’ health, productivity, and most of all – happiness.

Postmates is an American company offering local delivery of restaurant-prepared meals and other goods. We had a chance to chat with **Annie Wu**, Sr. Director of Engagement & Culture at Postmates San Francisco – an office of almost 400 employees!

Like most rapidly growing companies, Postmates’ conference room shortage was quite problematic at the beginning. Wu couldn’t lease any additional space or build any enclosed rooms, but she could buy Framery’s space efficient pods (and even take that investment with her to their next office!). This was the first step toward a functional workplace – and space. “When I encountered the Framery O, I was blown away by the quality of construction and chic aesthetic. It felt very neutral and wouldn’t compete with other elements in our office,” says Wu.

“We were able to move all 1:1s out of conference rooms and into Framery products, allowing our larger [conference] rooms to be utilized to their maximum for larger team meetings. From the design, cost-efficiency and sustainability perspective, the decision to use Framery as a staple in our workplace design has been a no-brainer,” Wu states. —

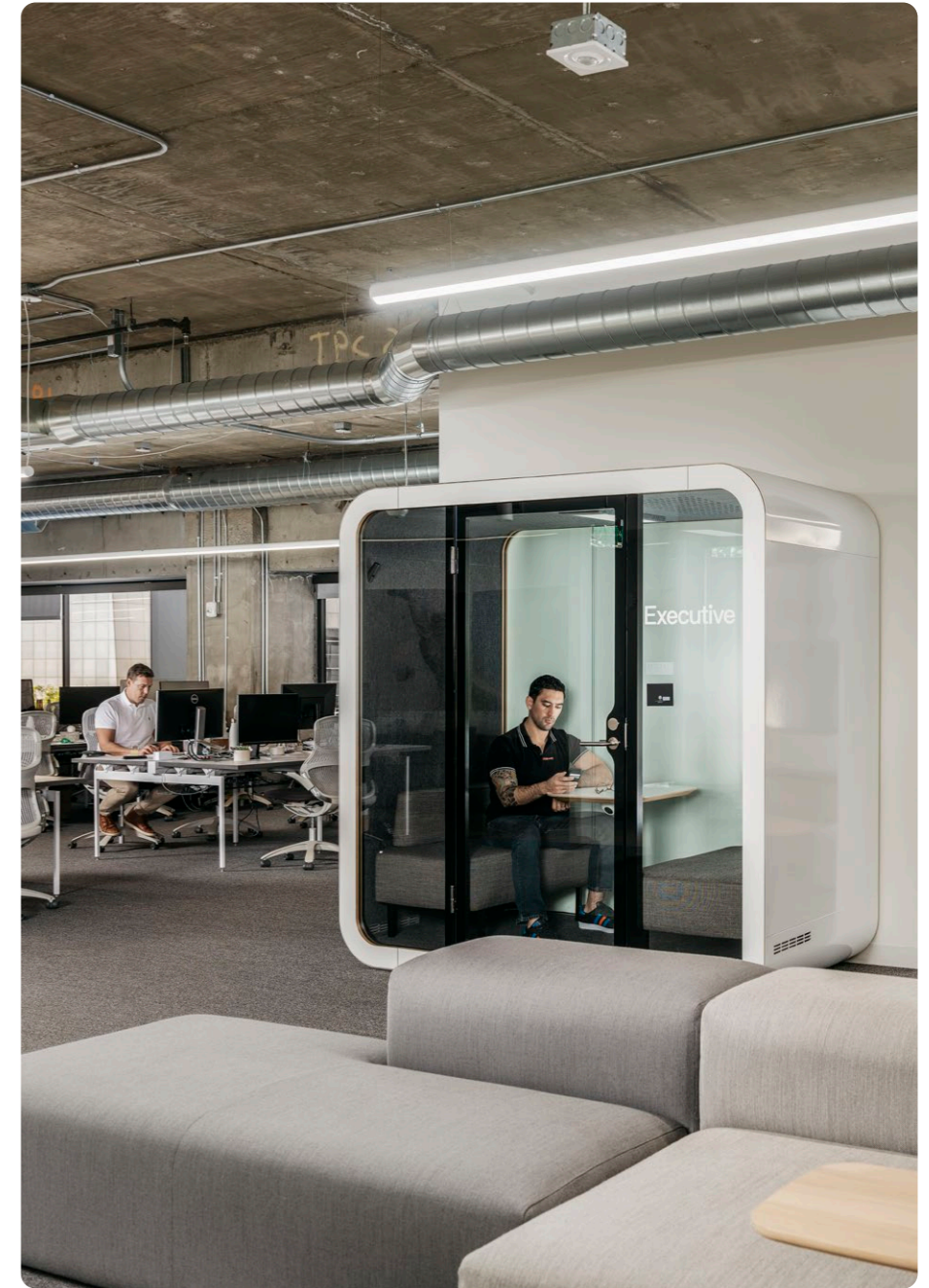

# Tampere Children's Hospital



Bringing pods where privacy matters



“I believe that the pods have helped us to protect the privacy of our employees as well as the families’. It is easy to pop into the pod and have a confidential conversation about a family’s situation and needs. No reservation needed”, says **Anna Hemmi**, Nursing Director of Child and Adolescent Psychiatry at TAYS.



**F**ramery annually picks a cause to support that has a distinct, philanthropic purpose. Hospitals are places where we face the realities of life and at the same time long for personal privacy. Still, thousands of families experience lack of privacy in hospitals around the world. This was a challenge we wanted to help solve.

In 2019, we donated five soundproof pods to the Tampere Children's Hospital, in Tampere Finland.

**Framery's O and Q pods were placed in the Child and Adolescent Psychiatry and Paediatric Haematology and Oncology sections of the hospital.**

“It's not unheard of that, for instance in the ER, several people can listen to private conversations between doctors and family members. Some hospitals try to reduce this by offering earplugs or similar distractors. We think that everyone should have the opportunity to be heard in a safe environment”, says Framery CEO **Samu Hällfors**.

Continuing on the same note, **Tuula Olkinuora**, Head Nurse in Children's Neuropsychiatry described that the benefits of the pods reach further than just the patients and their families. Doctors, psychologists and social workers, find the quiet space useful when for example making notes or dictating thoughts about appointments for later use.

“Sometimes people go in and pretend to fill out forms. Still, the main reason for stopping might be to just breathe and have a moment for themselves in the middle of a hectic day”, added **Janne Räsänen**, Head Nurse of Paediatric Haematology and Oncology at TAYS. —

# Conference Rooms vs. Framery Pods

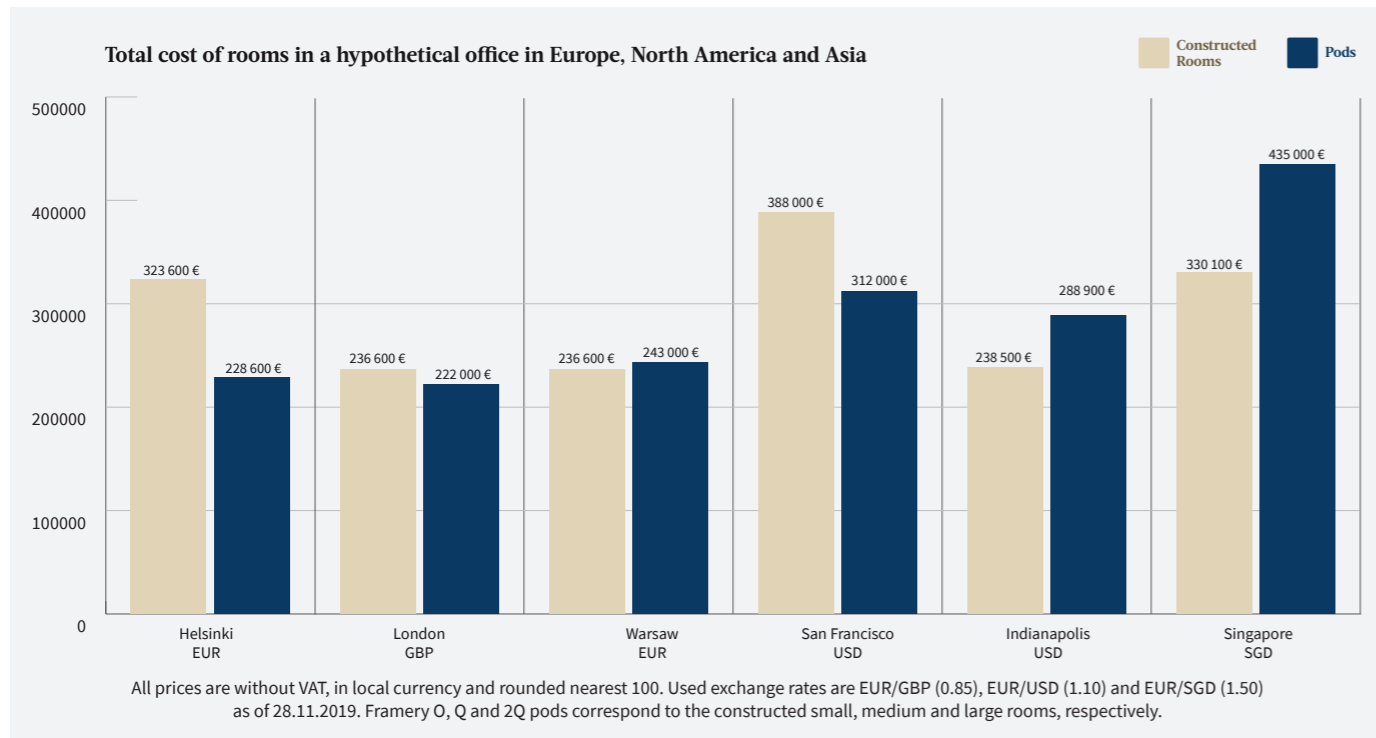

Office tenants and managers often inquire which kind of rooms, pods or constructed conference areas, are more cost efficient in the short and long term. In a recent study Framery teamed up with commercial real estate services firm, CBRE Finland, and compared the total costs of one, four and six-person Framery pods to the cost of constructed rooms of equal size in Europe, North America and Asia. The findings revealed interesting insights meant to provide office tenants and managers with the tools necessary to make informed decisions about the design and layout of their space.

“The research touches on a very common topic in office leasing and real estate development. Despite the prevalence of the topic, relatively

little research has been done on the subject. As one of the leading suppliers of soundproof pods and mobile meeting rooms, Framery was truly innovative in proposing a collaborative effort to clarify the matter.”, says **Ilkka Niska**, Director of Project Management and Workplace Consulting at CBRE Finland.

While the study was done in tandem with both companies, CBRE Finland took on the responsibility of all the calculations and calculation analysis. The research varies on the size of the hypothetical office and its location. The charts below for the costs of rooms and lifecycle costs are calculated with a setup of twelve small, six medium and three large rooms in a medium-sized flexible workplace and are compared with a single-person

Framery O, 2-4 person Framery Q and 4-6 person Framery 2Q. The pod prices are based on estimates for the average total of costs in the specific market areas for transportation and assembly, so that the hypothetical pods are ready for use!

Overall, we discovered that small conference rooms are often more expensive than the corresponding Framery pods in every city across Europe, North America and Asia. This outcome is partially due to the fact that the total cost of constructing a conference space and maintaining it is higher than the price of purchasing a pod and its upkeep.

For lifecycle cost comparisons, we’ve crafted four different, yet common, office scenarios that would impact the estimated price and cost over time for constructed rooms and pods.

- Scenario one** is based on the idea that the tenant moves to a new office at the end of a lease period and designs that new space to reflect the company’s original office layout.
- Scenario two** is when the tenant moves to a new office and after using it for a period of time, relocates 25% of the phone booths and meeting rooms to the new working environment.
- Next is **scenario three** in which a tenant moves to a new office and after some time relocates 75% of the phonebooth and meeting rooms to that space.
- Lastly, **scenario four** is when the tenant moves to a new office and at the end of the lease period returns the office to its original layout and integrates 100% of these dedicated rooms and/or pods again.

The main idea here is that the tenant can take all of their previously purchased pods with them, and use them in a new office or construct a relative amount of fixed meeting rooms again in a new office. Wherever you might fall within these crafted scenarios, there is likely one that might line up closest with your future plans for the office, and the cost comparisons for life cycles between constructed conference rooms and Framery pods will help make the best decision based on those projected plans.

In terms of total lifecycle costs, the long-term cost benefit of pods outweighs that of newly built infrastructure for the tenant. Let’s say for example, that if the total life-cycle cost of rooms in Helsinki is indicative for life-cycle costs in other cities, larger pods may be a more optimal choice than comparative constructed rooms. A reason for this is because **Framery pods are movable, and constructed conference rooms are not**. That said, if a business decides to move locations, the lifecycle cost of a Framery pod is more valuable than that of a built-in conference room.

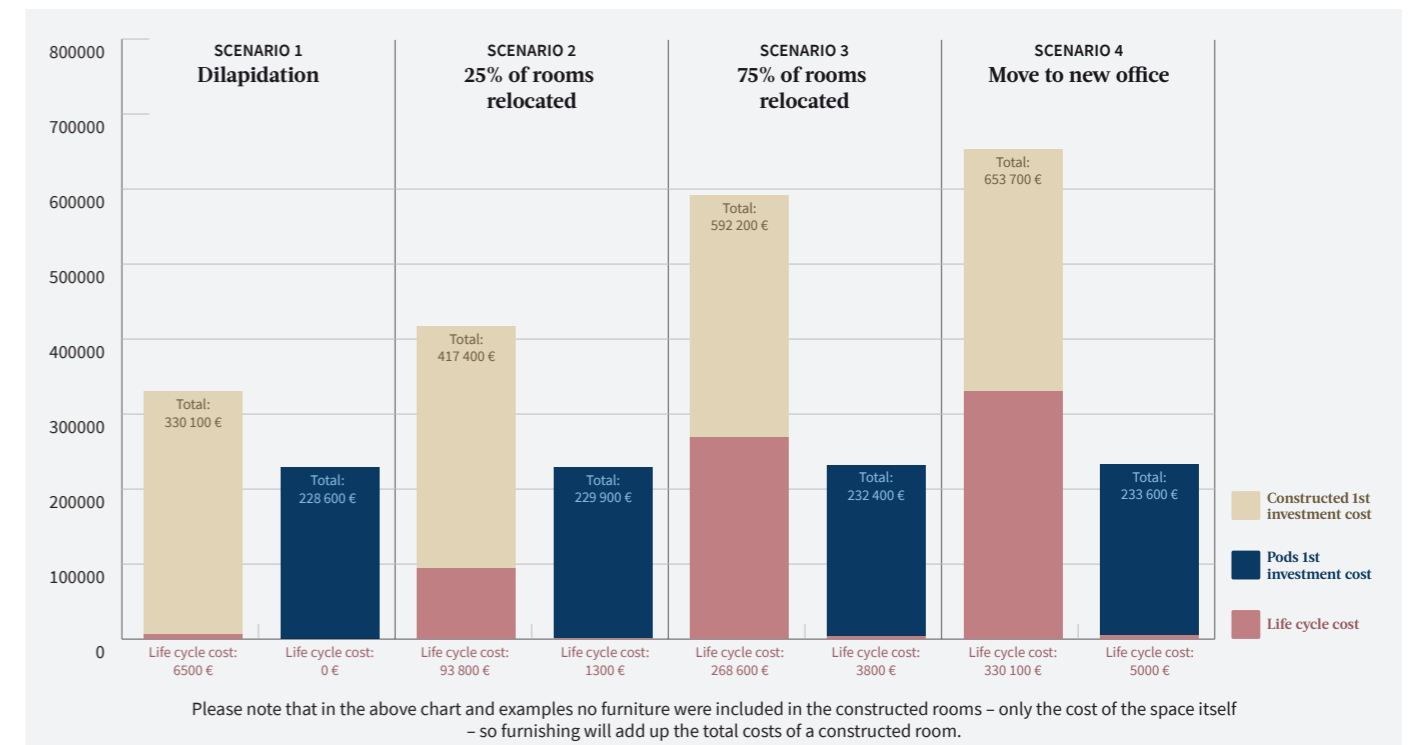

**For example, in Helsinki specifically, purchasing a Framery O pod is nearly 50% less expensive than building and constructing a small room.**

The study reveals that the choice between pods and constructed rooms depends heavily on the average size and cost of the office as well as the location in question and future plans for change. The lifecycle of a Framery pod is significantly less costly than that of a constructed conference room – not only saving clients’ money in the short term, but benefiting them in the long term as a worthwhile investment. ▶







COST OF USED SPACE

Room	Size	Amount in case office	Used space
Framery O	 1 m <sup>2</sup>	12	12 m <sup>2</sup>
Framery Q	 2,7 m <sup>2</sup>	6	16,2 m <sup>2</sup>
Framery 2Q	 6,6 m <sup>2</sup>	3	19,8 m <sup>2</sup>

Framery pods total used space: **48 m<sup>2</sup>**

Small room	 4 m <sup>2</sup>	12	48 m <sup>2</sup>
Mid size room	 9 m <sup>2</sup>	6	54 m <sup>2</sup>
Large room	 21 m <sup>2</sup>	3	63 m <sup>2</sup>

Constructed rooms total used space: **165 m<sup>2</sup>**

Sizes of Framery pods compared to average size of constructed rooms in case office. Totalling the amount of small, medium and large rooms, we can compare the total office space required by each solution. Source of average room sizes: CBRE Finland

City	Cost of m <sup>2</sup> annually	Cost of pods (48 m <sup>2</sup> )	Cost of rooms (165 m <sup>2</sup> )
Hong Kong	2 750 USD	132 009 USD	453 780 USD
New York	1 647 USD	79 050 USD	271 735 USD
Tokyo	1 345 USD	64 583 USD	222 006 USD
London	1 313 USD	63 033 USD	216 678 USD
San Fransisco	1 130 USD	54 250 USD	186 485 USD

Example of five cities with the worlds most expensive office space rent. Source of annual costs: Knight Frank

Folding into this conversation surrounding lifecycle comparison, pods are more cost efficient when considering the skyrocketing prices of real estate and office space across major cities. For example, in Helsinki specifically, purchasing a Framery O office phone booth is nearly 50% less expensive than building and constructing a small room. This is based on the cost of real estate and amount of space that is considered average in these locations.

Framery pods are designed to be as compact as possible, serving the needs of today's workplace climate. 80% of all meetings are held between one to four people – which means having an appropriately sized meeting space is cost efficient for the business and it's staff. Instead of constructing rooms or

expanding offices, Framery pods can be configured to fit within the existing office space and as a result, conveniently create additional rooms without the need for real estate expansion. It's a great investment of company capital, given that pods are flexible and can be configured to adapt to the existing office environment.

Other components to consider is the overall feature comparison between constructed rooms and movable pods. Office pods, given that they are a product for purchase, have a guaranteed level of performance and are more likely to meet expectations – they are also easy to move and can be placed anywhere in the existing workplace. However, when constructing a meeting room, the consumer might not be certain of

the type of acoustics and/or quality of sound insulation that would be a result of the newly built room.

“The study and the results of modular rooms being cost efficient and flexible solutions compared to constructed rooms has led to interesting discussions with both landlords and tenants.” continues **Ilkka Niska**, Director of Project Management and Workplace Consulting at CBRE Finland. “I'm looking forward to seeing how the needs of the office change in the near future and what impact it will have on the subject of this study.” —

Information Source: *Movable Pods or Constructed Rooms?*

Office pods have a guaranteed level of performance, are easy to move and can be placed anywhere in the existing workplace.



# Framery product family



# Framery One

Not a dumb pod











**Framery One**, our first digital soundproof pod. Framery One is not only stylish and super smart, it incorporates the latest technology, leading sound insulation standards and echo-free acoustics. You can look forward to a highly adaptable workspace where you won't be disturbed by outside noise or distractions and can enjoy best-in-class design while you focus on your next project.



Stepping into the pod, Framery One's occupancy light will display a red light with **360° visibility** to let the office know the pod is in use. Using the **pod's touch-screen**, the user is able to adjust the airflow and brightness of the lights according to his/her own preferences. With Framery One's integrated 4G module, the user will always stay connected. **Calendar integration** allows reservations for the pod from the user's laptop. **Seamless connection** between the pod, user and Framery. Whether it's about new features, calendar issues, updates or maintenance requests – everything can be handled remotely or digitally.

## Color options



### Exterior

 White Standard RAL 9016 Ultramatt	 Black Standard RAL 9005 Ultramatt	 Gray Standard S7500-N Ultramatt	 Navy NCS S 7020 - R90B Ultramatt	 Powder Blue NCS 3421-R86B Ultramatt	 Sand NCS S 2010 - Y20R Ultramatt	 Blush NCS 2728-R01B Ultramatt	 Winter Moss S 7010-G10Y Ultramatt
--	--	--	---	--	---	--	--

### Interior panels

 Pure Gray Standard Tonal #60123 Gabriel	 Navy Atlantic #66057 Gabriel	 Sand Tonal #61180 Gabriel	 Rouge Tonal #64210 Gabriel
---	--	---	--

### Table

 White Standard White laminate	 Black Black laminate with anti-fingerprint surface	 Oak Oak veneer
---	--	--

### Carpet

 Light Gray Standard Ex-dono Quartet #393330 Fletco Carpets	 Dark Blue Zenith #T371880 Fletco Carpets	 Champagne Zenith #T371210 Fletco Carpets	 Grape Zenith #371680 Fletco Carpets
---	---	---	--

### Frames

 Black RAL 9005
--

### Seat fabrics

 Graphite Standard Select #60051 Gabriel	 Dark Blue Select #66144 Gabriel	 Powder Blue Select #67098 Gabriel	 Beige Select #61184 Gabriel	 Mustard Select #62098 Gabriel	 Grape Select #61190 Gabriel	 Rose Select #65117 Gabriel	 Green Select #68209 Gabriel
---	---	---	---	---	---	--	---

# Technical specifications



## Framery One features and options

- Colors
  - 8 Exterior panel colors
  - 4 Interior panel colors
  - 8 Seat fabric colors
  - 4 Carpet colors
  - 3 Table colors
- Framery Connect
- Occupancy indicator
- Wireless charger
- Activated carbon filter
- LAN
- Movability kit
- Seismic anchors

More about Framery One on our website

The adjustable work surface provides ample space for laptops, personal devices and other work tools. The electric height adjustable table can be positioned vertically between 70 - 120 cm (27,6 - 47,2 in) to allow for different working positions and provide comfort for all users.

	Measurements - cm	Measurements - in
<b>Exterior</b>	225,5 cm x 122 cm x 100 cm (height, width, depth)	88,8 in x 47,9 in x 40 in (height, width, depth)
<b>Interior</b>	204 cm x 102 cm x 93 cm (height, width, depth)	80,3 in x 40 in x 36,7 in (height, width, depth)
<b>Door (left- and right-handed)</b>	Doorway 204 cm x 101,5 cm (height, width)	Doorway 80,2 in x 40 in (height, width)
<b>Table</b>	76 cm x 45 cm (width, depth) Adjustment height 70 cm - 120 cm	30 in x 17,7 in (width, depth) Adjustment height 27,6 in - 47,2 in
<b>Adjustable seat height</b>	59 cm - 85 cm	23,2 in x 33,5 in

The door handedness can be changed on-demand with simple tools, by flipping the front frame in its place. No additional components are needed, should the customer want to have the door opening to the right instead of left.

## UI panel

High resolution touchscreen

### Outlet

1 power socket + USB C socket + optional LAN (extra cost)

Adjust airflow & brightness of the light according to your own preference from the touchscreen. See both the availability of the pod and/or book a reservation (by using the optional calendar integration) from your own laptop or phone or just walk in and the pod reserves itself automatically for you. Integrated 4G technology module enables three way communication between you, the pod and Framery. Whether it's about calendar reservation, pod maintenance, updates or notifications, all matters related to the Framery One pod are handled remotely (digitally).

Features		
<b>Exterior</b>	Powder coated deep-drawn steel panels	
<b>Interior</b>	Replaceable interior panels made from PET sheets which are laminated with polyester fabric	
<b>Glass</b>	Sound control laminated glass	
<b>Frames</b>	Semi-gloss black frames made from steel & aluminum	
<b>Solid walls and floor</b>	A sandwich element chassis, made of deep-drawn sheet metal & recycled acoustic foam. Fabric interior panels and an anti-static and stain resistant low loop pile carpet for the floor.	
<b>Tabletop</b>	Formica laminate on birch plywood with varnish trim	
<b>Weight</b>	325 kg / 716,5 lb	
<b>Airflow</b>	Maximum airflow is 29 l/s. (Minimum recommended space for the air to circulate is 5 cm / 1,9" on the sides - 20 cm / 8" above the pod.)	
<b>Acoustics</b>	Speech level reduction (D <sub>s,A</sub> ) according to ISO 23351-1 testing method: >30 dB	
Power		
<b>Power consumption</b>	<b>35 W while in use (Default)</b> LED lights: 19 W Fans in total: 7 W <b>6 W standby power consumption</b> Fans are working on 25 % of the maximum power	<b>Maximum power consumption:</b> 80 W total LED light: 24 W Fans in total: 9 W USB C charger: 21 W Wireless charger: 12 W <b>Input:</b> 100-240 VAC, 10,0 A, 50-60 Hz
	<b>Outlets</b>	<b>Always included</b> Power socket + USB charger  <b>Optional</b> Wireless charger LAN
<b>Output values</b>	<b>Output VAC (power socket):</b> 100-240 VAC, 6,6 A, 50-60 Hz <b>Output USB C charger:</b> 18 W <b>Output Qi wireless charger:</b> 10 W	

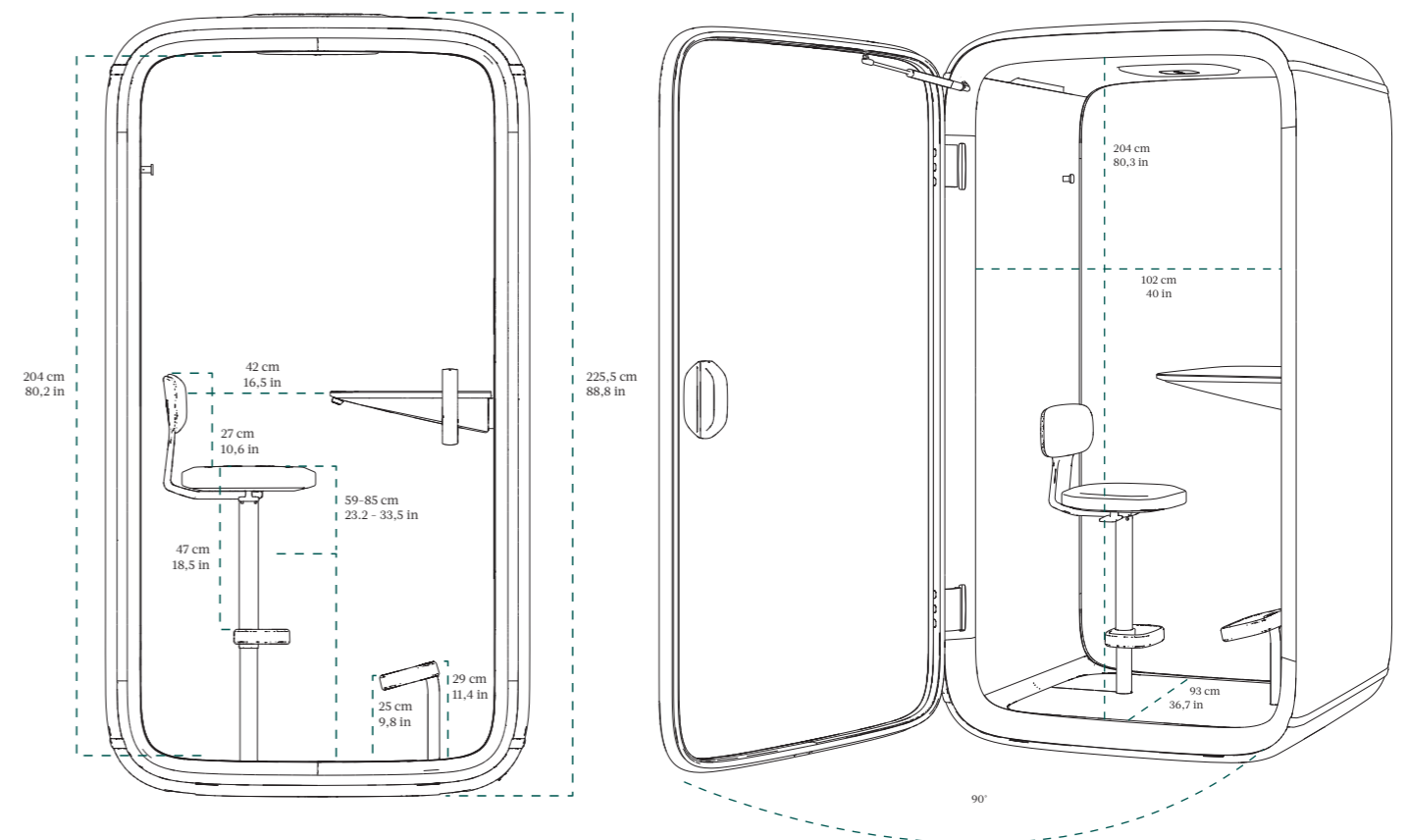

# Framery O

Ideal for one – awkward for two



Framery O is ideal for important calls or video conferences. Have your discussions in privacy without disturbing your colleagues. The classic office phone booth delivers leading sound insulation standards and echo-free acoustics, providing a comfortable working environment for one.

## Perfect for you

How do you work best? Choose the interior layout that best suits your needs.



### For quick calls

If you work best on your feet, choose Framery O without a seat. Perfect for those quick ad-hoc calls and standing work. Installation is fast and the pod is ready to be used the same day it's delivered.



### Videoconferences are here to stay















Framery O is also available in the Video Conference Ready variant. A tilting screen bracket and the LED lighting surrounding the screen provide optimal conditions for videoconferences, with the control panel enabling you to adjust the lighting and airflow inside the pod.

## Color options

### Exterior

 White Standard RAL 9016 Glossy, Ultramatt or Whiteboard paint finish	 Black RAL 9005 Ultramatt	 Cloudy Gray RAL 850-2 Ultramatt	 Misty Blue RAL 620-3 Ultramatt	 Petrol Blue RAL 690-6 Ultramatt	 50's Blue RAL 6034 Ultramatt	 Burned Orange RAL 410-5 Ultramatt
	 Purple Red RAL 3004 Ultramatt	 Lemon RAL 1012 Ultramatt	 Piglet Pink RAL 940-6 Ultramatt	 Forest Green RAL 750-4 Ultramatt	 Spring Green RAL 230-6 Ultramatt	 Brushed Stainless Steel

### Frame

 White Standard F6463 Formica	 Black F2253 Formica	 Cloudy Gray F0189 Formica	 Misty Blue F1998 Formica	 Petrol Blue 850 Abet Laminati	 50's Blue F7879 Formica	 White Standard White laminate
 Burned Orange F2962 Formica	 Purple Red F7966 Formica	 Lemon 0647 Arpa Industriale	 Piglet Pink 830 Abet Laminati	 Forest Green F7967 Formica	 Spring Green 0630-60 Resopal	 Black Black laminate

### Upholstery

 Light Gray Standard Remix 3 #123 Kvadrat	 Black Remix 3 #183 Kvadrat	 Cloudy Gray Divina MD #733 Kvadrat	 Misty Blue Divina Melange 2 #731 Kvadrat	 Petrol Blue Divina MD #843 Kvadrat	 50's Blue Divina MD #813 Kvadrat
 Burned Orange Divina 3 #542 Kvadrat	 Purple Red Divina MD #633 Kvadrat	 Lemon Divina Melange 2 #421 Kvadrat	 Piglet Pink Divina MD #613 Kvadrat	 Forest Green Divina 3 #876 Kvadrat	 Spring Green Divina Melange 2 #971 Kvadrat

# Technical specifications



**Regular**  
13 x 70 x 28,5 cm  
5,1 x 27,5 x 11,2 in



**Wide**  
12 x 75 x 30 cm  
4,7 x 29,5 x 11,8 in



**Adjustable stool**  
68,5 - 81,5 cm  
26,8 - 31,9 in

## Framery O options

### Standard

- Frame, exterior and seat colors
- 2 Table options (Regular, Wide)
- Wireless charger (for Wide table)
- Self-closing hinges
- Electromechanical code lock
- LAN

### Video Conference Ready

- Frame, exterior and seat colors
- Wireless charger
- Self-closing hinges
- Electromechanical code lock
- LAN

## Framery O - Video Conference Ready

Adjust:

- Brightness of the ceiling light
- Brightness of LED surrounding the screen
- Capacity of the airflow

### Control Panel

### Screen bracket

**Screen specifications:**  
Tilting screen bracket. Maximum display size 24" with flat VESA 100 x 100 mounting surface. Screen not included

## Features

<b>Exterior</b>	Painted sheet metal or brushed stainless steel
<b>Glass</b>	Sound control laminated glass
<b>Frame and table</b>	Formica laminate on birch plywood with varnish trim
<b>Solid walls, roof and floor</b>	A sandwich element of sheet metal, birch plywood, recycled acoustic foam and acoustic felt. An anti-static and stain resistant low loop pile carpet for interior floor.
<b>Weight</b>	320 kg / 705 lb
<b>Airflow</b>	Total airflow is 21,5 l/s / 77,4 m <sup>3</sup> /h (Minimum recommended space for the air to circulate is 5 cm / 1,9" on the sides - 15 cm / 5,9" above the pod.)
<b>Acoustics</b>	Speech level reduction (D <sub>s,A</sub> ) according to ISO 23351-1 testing method: 30 dB

## Measurements - cm

<b>Exterior</b>	221 cm x 100 cm x 100 cm (height, width, depth)
<b>Interior</b>	200 cm x 80 cm x 95 cm (height, width, depth)
<b>Door (left-handed only)</b>	Doorway 84 cm - clear opening width 78,5 cm

## Measurements - in

<b>Exterior</b>	87 in x 40 in x 40 in (height, width, depth)
<b>Interior</b>	78 in x 31,5 in x 37,4 in (height, width, depth)
<b>Door (left-handed only)</b>	Doorway 33 in - clear opening width 30,9 in

<b>Table</b>	<b>Regular:</b> 13 cm x 70 cm x 28,5 cm (height, width, depth)	<b>Regular:</b> 5,1 in x 27,5 in x 11,2 in (height, width, depth)
	<b>Wide:</b> 12 cm x 75 cm x 30 cm (height, width, depth)	<b>Wide:</b> 4,7 in x 29,5 in x 11,8 in (height, width, depth)
	Table height from floor: 102,5 cm	Table height from floor: 40 in

Power cord can be led out of the bottom corner of the pod. The cord length outside the pods is 4,5 m / 177 in.

## Framery O - Standard

<b>Power consumption</b>	<b>13 W while in use (Default)</b> LED light: 10 W Fans in total: 3,1 W
	<b>0,8 W standby power consumption</b> Fans are working on 25 % of the maximum power
	<b>Maximum power consumption:</b> 15 W total LED light: 11 W Fans in total: 3,1 W
	<b>Input:</b> 100-240 VAC, 8,0 A, 50-60 Hz

## Framery O - Video Conference Ready

<b>Power consumption</b>	<b>28 W while in use (Default)</b> LED ceiling light: 10 W - LED wall light: 12,5 W Fans in total: 3,1 W
	<b>0,8 W standby power consumption</b> Fans are working on 25 % of the maximum power
	<b>Maximum power consumption:</b> 40 W total LED ceiling light: 11 W - LED wall light: 25 W Fans in total: 3,1 W
	<b>Input:</b> 100-240 VAC, 8,0 A, 50-60 Hz

### Outlets

<b>Regular table:</b> Power socket + optional LAN (extra cost) Framery O Standard is available with both table options	<b>Wide table:</b> Power socket + Twin USB charger + LAN (extra cost) Framery O VCR comes with Wide table only
--	--

### Output values

<b>Output VAC (power socket):</b> 100-240 VAC, 6,6 A, 50-60 Hz
<b>Output USB (TUF) charging:</b> Maximum combined output of 5 A at 5 VDC ( 25 W)

All electric components can be changed if there is a malfunction. Power consumption is a constant value that is determined by the power usage of the pods' internal components (electric unit, motion detector, light and fans). Framery's products can be plugged into a wall socket. The pods have their own power supplies that give 24 V DC to the lights and 12 V DC to the fans. The lights and fans are operated by a motion detector. Inside the pods, there are country-specific power outlets for charging mobile devices.



# Framery Q

Two is company, four is a party – everyone fits



**Framery Q** office pod is a multifunctional, soundproof space for 1-4 people to have meetings, brainstorming sessions and important one-on-one conversations in private without disturbing the office – or the office disturbing you.



## Comfortable privacy for longer meetings

Suitable for meetings, brainstorming and much more. Two Maggie Sofas are always included, and you can choose them with a curved or straight backrest. There are also three different table options available.

- Frame, exterior and sofa colors
- 2 Maggie Sofas
- 3 Table options
- 3 Power sockets

### Maggie Sofa upholstery options

- |   |   |
|---|---|
| ● Maggie Gray Standard<br>Canvas 3 #154 Kvadrat | ● Black<br>Remix 3 #183 Kvadrat                 |
| ● Petrol Blue<br>Divina MD #843 Kvadrat         | ● 50's Blue<br>Divina MD #813 Kvadrat           |
| ● Lemon<br>Divina Melange 2 #421 Kvadrat        | ● Piglet Pink<br>Divina MD #613 Kvadrat         |
| ● Cloudy Gray<br>Divina MD #733 Kvadrat         | ● Misty Blue<br>Divina Melange 2 #731 Kvadrat   |
| ● Burned Orange<br>Divina 3 #542 Kvadrat        | ● Purple Red<br>Divina MD #633 Kvadrat          |
| ● Forest Green<br>Divina 3 #876 Kvadrat         | ● Spring Green<br>Divina Melange 2 #971 Kvadrat |



## For shared videoconferences

A high table and handy bar stools make the Working With PAL interior layout very efficient for short-term sessions. The shape of the desk is suitable for teamwork for two, private sessions or video conferences. You can choose from two height options for both the table and PAL stools.

### PAL stool color options

- White
- Black

### PAL stool felt cap

- Cloudy Gray  
Divina MD #733 Kvadrat

- Frame and exterior colors
- 2 PAL stools (black or white)
- 2 Table height options
- Standard 90 cm / 35.4 in
- High 110 cm / 43.3 in
- 2 Power sockets



## Heads-down work

Designed for uninterrupted heads-down work. It comes with an adjustable electric table that allows you to change your working position from sit-to-stand in a matter of seconds. The Flow has plenty of space inside for a chair and even an extra stool, making it possible to invite your colleague in for a chat or a shared videoconference.

- Frame and exterior colors
- Adjustable electric table



## For easy access

One of the more convenient and flexible interior alternatives for the Framery Q office pod. Low doorstep, a wider door with an automatic opener, folding chairs and table enable many different meeting arrangements and easy access with a wheelchair.

- Frame and exterior colors
- Accessible
- Automatic door opener

# Technical specifications

## Color options

<b>Exterior</b>						
White Standard RAL 9016 Glossy, Ultramatt or Whiteboard paint finish	Black RAL 9005 Ultramatt	Cloudy Gray RAL 850-2 Ultramatt	Misty Blue RAL 620-3 Ultramatt	Petrol Blue RAL 690-6 Ultramatt	50's Blue RAL 6034 Ultramatt	Burned Orange RAL 410-5 Ultramatt
White Standard F6463 Formica	Purple Red RAL 3004 Ultramatt	Lemon RAL 1012 Ultramatt	Piglet Pink RAL 940-6 Ultramatt	Forest Green RAL 750-4 Ultramatt	Spring Green RAL 230-6 Ultramatt	Brushed Stainless Steel
<b>Frame</b>						
White Standard F6463 Formica	Black F2253 Formica	Cloudy Gray F0189 Formica	Misty Blue F1998 Formica	Petrol Blue 850 Abet Laminati	50's Blue F7879 Formica	
Burned Orange F2962 Formica	Purple Red F7966 Formica	Lemon 0647 Arpa Industriale	Piglet Pink 830 Abet Laminati	Forest Green F7967 Formica	Spring Green 0630-60 Resopal	



More about Framery Q on our website

	Framery Q	Framery Q Flip n' Fold
<b>Power consumption</b>	<b>20 W while in use (Default)</b> LED lights: 11 W Fans in total: 8,6 W <b>2,1 W standby power consumption</b> Fans are working on 25 % of the maximum power	<b>Maximum power consumption:</b> 23 W total LED light ceiling: 13,5 W Fans in total: 8,6 W <b>Framery Q Flow adjustable table:</b> 149 W total (when table height is adjusted) <b>Input:</b> 100-240 VAC, 8.0 A, 50-60 Hz
<b>Outlets</b>	2 power sockets + 2 Twin USB chargers + optional LAN (extra cost)	2 power sockets + 2 Twin USB chargers
<b>Output values</b>	<b>Output VAC (power socket):</b> 100-240 VAC, 6,6 A, 50-60 Hz <b>Output USB (TUF) charging:</b> Maximum combined output of 5 A at 5 VDC ( 25 W)	

	Features
<b>Exterior</b>	Painted sheet metal or brushed stainless steel
<b>Glass</b>	Sound control laminated glass
<b>Frame and table</b>	Formica laminate on birch plywood with varnish trim
<b>Solid walls, roof and floor</b>	A sandwich element of sheet metal, birch plywood, recycled acoustic foam and acoustic felt. An anti-static and stain resistant low loop pile carpet for interior floor.
<b>Weight (without furniture)</b>	630 kg / 1389 lb
<b>Airflow</b>	Total airflow is 66 l/s / 237,6 m <sup>3</sup> /h (Minimum recommended space for the air to circulate is 5 cm / 1.9" on the sides - 15 cm / 5.9" above the pod.)
<b>Acoustics</b>	Speech level reduction (D <sub>s,A</sub> ) according to ISO 23351-1 testing method: 29 dB

Power cord can be led out of the bottom corners of the pod. The cord length outside the pods is 4,5 m / 177 in.

Framery Q	Measurements - cm	Measurements - in
<b>Exterior</b>	222 cm x 220 cm x 120 cm (height, width, depth)	87,4 in x 86,6 in x 47,2 in (height, width, depth)
<b>Door</b>	Doorway 86 cm Clear opening width 82 cm	Doorway 33,8 in Clear opening width 32,3 in
<b>Tables</b>	<b>Meeting Maggie</b> Turnable: 70 cm x 71 cm x 53 cm (height, width, depth) Oval: 70 cm x 71 cm x 68 cm (height, width, depth) <b>Meeting Maggie and Working With PAL</b> Full width: 200 cm x 60 cm (width, depth) <b>Flow</b> Adjustable electric table: 100 cm x 56 cm (width, depth) 65 cm - 125 cm (height adjustment)	<b>Meeting Maggie</b> Turnable: 27,5 in x 28 in x 20,8 in (height, width, depth) Oval: 27,5 in x 28 in x 26,8 in (height, width, depth) <b>Meeting Maggie and Working With PAL</b> Full width: 78,7 in x 23,6 in (width, depth) <b>Flow</b> Adjustable electric table: 39,4 in x 22 in (width, depth) 25,6 in - 49,2 in (height adjustment)
<b>PAL stools</b>	<b>PAL 90:</b> 65 cm (height) <b>PAL 110:</b> 80 cm (height)	<b>PAL 90:</b> 25,6 in (height) <b>PAL 110:</b> 31,5 in (height)

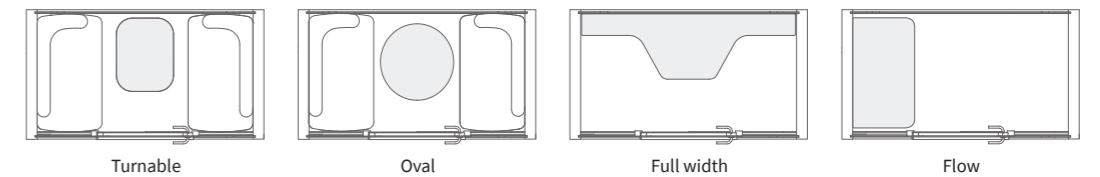

Framery Q Flip n' Fold	Measurements - cm	Measurements - in
<b>Exterior</b>	221 cm x 220 cm x 120 cm (height, width, depth)	87,3 in x 86,6 in x 47,2 in (height, width, depth)
<b>Door (left-handed only)</b>	Doorway clear opening width 91,5 cm	Doorway clear opening width 36 in
<b>Platform</b>	99 cm x 60 cm (width, depth)	39 in x 23,6 in (width, depth)

Framery Q Flip n' Fold features ADA 2010 compliant T-shaped turning space and threshold.

	Framery Q - Meeting Maggie, Working With PAL 90
<b>Screen bracket</b>	Framery Q screen bracket is located on the center of the back glass. Display mounting with counterpiece 4 x magnets. <b>Screen specifications:</b> Maximum display size 27" Maximum weight 6,5 kg / 14 lbs with flat VESA 75 x 75 or VESA 100 x 100 mounting surface. Screen not included.

All electric components can be changed if there is a malfunction. Power consumption is a constant value that is determined by the power usage of the pods' internal components (electric unit, motion detector, light and fans). Framery's products can be plugged into a wall socket. The pods have their own power supplies that give 24 V DC to the lights and 12 V DC to the fans. The lights and fans are operated by a motion detector. Inside the pods, there are country-specific power outlets for charging mobile devices.



# Framery 2Q

Not only a pod, but a full-sized meeting room



Framery 2Q meeting pod is designed for 4-6 people, making it the ideal place to co-create, brainstorm and have meetings. Our superior sound insulation and echo-free acoustics ensure that your meetings won't disturb the office – and the office noise won't disturb you.

## Perfect for you

How do you work best? Choose the interior layout that best suits your needs.



### Get together in comfort

Gather your team around the table for a Monday morning meeting or Tuesday afternoon brainstorming session. A meeting table with two different height options makes this interior layout optimal for laptop use or some creative collaboration. Want to dim the lighting or adjust the airflow? You can control the pod's settings from its clever control panel, located on the power column. Additional options include a display bracket or a whiteboard.



### Living room in your office

Framery 2Q Lounge interior provides a more casual environment for company meetings, a calm space to retreat to during the workday, or an area for socialization. Custom-designed Clint Sofa, large whiteboard, free-standing Piaggio table and a wall shelf make up for a functional yet relaxed setting. The adjustable airflow and lighting create a happy atmosphere to work in. Additional options include, for example, a display bracket on the wall for a TV or a booking system ready option for the door for reserving the pod.

## Color options

### Exterior

White Standard

RAL 9016 Glossy, Ultramatt or Whiteboard paint finish

Burned Orange

RAL 410-5 Ultramatt

Black

RAL 9005 Ultramatt

Purple Red

RAL 3004 Ultramatt

Cloudy Gray

RAL 850-2 Ultramatt

Lemon

RAL 1012 Ultramatt

Misty Blue

RAL 620-3 Ultramatt

Piglet Pink

RAL 940-6 Ultramatt

Petrol Blue

RAL 690-6 Ultramatt

Forest Green

RAL 750-4 Ultramatt

50's Blue

RAL 6034 Ultramatt

Spring Green

RAL 230-6 Ultramatt

### Frame

White Standard

F6463 Formica

Burned Orange

F2962 Formica

Black

F2253 Formica

Purple Red

F7966 Formica

Cloudy Gray

F0189 Formica

Lemon

0647 Arpa Industriale

Misty Blue

F1998 Formica

Piglet Pink

830 Abet Laminati

Petrol Blue

850 Abet Laminati

Forest Green

F7967 Formica

50's Blue

F7879 Formica

Spring Green

0630-60 Resopal

### Clint sofa upholstery

Clint Lemon Standard  
Steelcut Trio 3 #446 Kvadrat

Burned Orange  
Divina 3 #542 Kvadrat

Clint Gray Standard  
Fiord 2 #151 Kvadrat

Purple Red  
Divina MD #633 Kvadrat

Cloudy Gray  
Divina MD #733 Kvadrat

Piglet Pink  
Divina MD #613 Kvadrat

Misty Blue  
Divina Melange 2 #731 Kvadrat

Forest Green  
Divina 3 #876 Kvadrat

Petrol Blue  
Divina MD #843 Kvadrat

Spring Green  
Divina Melange 2 #971 Kvadrat

50's Blue  
Divina MD #813 Kvadrat

# Technical specifications



More about Framery 2Q on our website

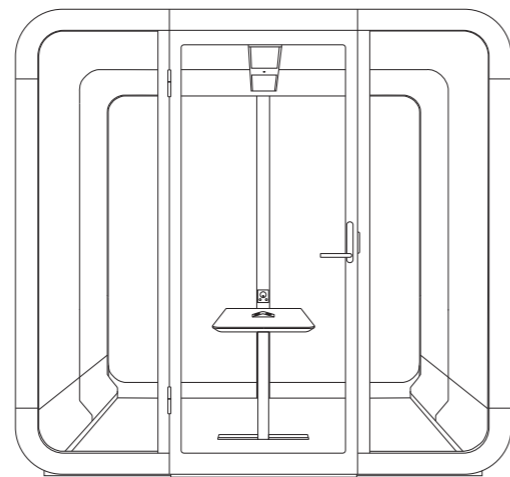
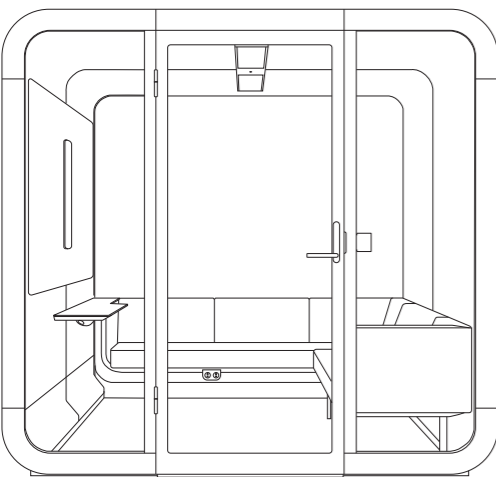

	Features
<b>Exterior</b>	Painted sheet metal
<b>Glass</b>	Sound control laminated glass
<b>Frame and table</b>	Formica laminate on birch plywood with varnish trim
<b>Solid walls, roof and floor</b>	A sandwich element of sheet metal, birch plywood, recycled acoustic foam and acoustic felt. An anti-static and stain resistant low loop pile carpet for interior floor.
<b>Weight (without furniture)</b>	950 kg / 2094 lb
<b>Airflow</b>	Total airflow is 121 l/s / 436 m³/h (Minimum recommended space for the air to circulate is 20 cm / 7,9 in above the pod)
<b>Acoustics</b>	Speech level reduction (D <sub>s,A</sub> ) according to ISO 23351-1 testing method: 29 dB

	Measurements - cm	Measurements - in
<b>Exterior</b>	220 cm x 235 cm x 280 cm (height, width, depth)	86,6 in x 92,4 in x 110,4 in (height, width, depth)
<b>Interior</b>	200 cm x 80 cm x 95 cm (height, width, depth)	78 in x 31,5 in x 37,4 in (height, width, depth)
<b>Door (left-handed only)</b>	Doorway 86 cm - Clear opening width 82 cm	Doorway 33,8 in - Clear opening width 32,3 in
<b>Table</b>	<b>Framery 2Q Standard - working height:</b> Standard table: 72 cm High table: 90 cm <b>Framery 2Q Lounge :</b> Wall shelf: 175 cm (length) Piaggio table: 63 cm x 42 cm x 36 cm (height, width, depth)	<b>Framery 2Q Standard - working height:</b> Standard table: 28,3 in High table: 35,4 in <b>Framery 2Q Lounge :</b> Wall shelf: 68,9 in (length) Piaggio table: 24,8 in x 16,5 in x 14,2 in (height, width, depth)

Standard: Power cord can be led from the floor. The cord length is 2,7 m / 106,3 in  
 Lounge: Power cord can be only led out of the bottom from back-side of the pod, the length is 3,5 m / 137,8 in

	Power
<b>Power consumption</b>	<b>42 W while in use (Default)</b> LED lights: 24 W Fans in total: 18 W <b>5 W standby power consumption</b> Fans are working on 25 % of the maximum power <b>Maximum power consumption:</b> 45 W total LED light ceiling: 27 W Fans in total: 18 W <b>Input:</b> 100-240 VAC, 8.0 A, 50-60 Hz
<b>Outlets</b>	<b>Framery 2Q Empty</b> 3 power sockets + 2 Twin USB chargers <b>Framery 2Q Standard</b> 4 power sockets + 2 Twin USB chargers + HDMI Both outlet options available for order with LAN <b>Framery 2Q Lounge</b> <b>Wall shelf</b> 2 power sockets + 2 Twin USB chargers <b>Clint sofa</b> 4 power sockets (2 under each sofa)
<b>Output values</b>	<b>Output VAC (power socket):</b> 100-240 VAC, 6,6 A, 50-60 Hz <b>Output USB (TUF) charging:</b> Maximum combined output of 5 A at 5 VDC ( 25 W)

All electric components can be changed if there is a malfunction. Power consumption is a constant value that is determined by the power usage of the pods' internal components (electric unit, motion detector, light and fans). Framery's products can be plugged into a wall socket. The pods have their own power supplies that give 24 V DC to the lights and 12 V DC to the fans. The lights and fans are operated by a motion detector. Inside the pods, there are country-specific power outlets for charging mobile devices.

	Framery 2Q Standard	Framery 2Q Lounge
<b>Screen bracket (optional)</b>	<b>Framery 2Q Standard and Empty</b> Located on the back glass, attached to the power column. <b>Screen specifications:</b> Maximum display size 50" - Recommended size 43" with flat VESA 100 x 100 or 200 x 200 (with adapter) mounting surface. Screen not included.	<b>Framery 2Q Lounge</b> Located on the center of the Lounge whiteboard. <b>Screen specifications:</b> Recommended size 50" - Maximum weight 30 kg / 66 lbs Tilting angle: +5/-8" VESA support: 100 x 100, 100 x 150, 150 x 100, 200 x 100, 100 x 200, 200 x 200, 300 x 200, 400 x 200. Screen not included.

## Product add-ons



### Copper-plated door handle

Copper has been used for health purposes since ancient times. According to a study by Centers for Disease Control and Prevention (CDC), The SARS-CoV-2 virus disintegrates quicker after landing on copper surfaces than on plastic or stainless steel surfaces. Available for Framery O, Q and 2Q.



### Booking system ready

Universal booking system bracket. Attached to the door locking plate. Bracket set includes 2 plates to choose from, large and small. Booking system can be connected to pod's electrical system. Maximum device weight 5 kg / 11 lbs. Available for Framery Q and 2Q.



### Movability kit

Relocating your Framery pod has never been this easy! Movability kit includes castors and fasteners that can be installed to the bottom of the pod for moving it. Available for Framery O, Q and One.



### Anti-Microbial, non-toxic polyester fabric

Anti-microbial, waterproof, bleach cleanable, stain resistant and durable polyester fabric. Our non-toxic material is safe and ISO 10993-5:2009 tested. Available for upholstered Framery furniture.



### Wireless charger

Charge your phone fast and wire-free inside our pods! The charger itself is located underneath the table, with a sticker on top of the table indicating where to place your phone to get it charged. Available for Framery One, O, Q (Meeting Maggie, Working With PAL) and 2Q.



### Whiteboard paint

Utilize the walls of your pod and choose the whiteboard paint covers. Perfect for quick brainstorming, making notes or leaving messages for your colleagues. Easy to clean. Available for Framery O, Q and 2Q.

## Product safety

Framery's Quality Management System is certified against ISO 9001 and Framery's Environmental Management System is certified against ISO 14001. CE marking is a manufacturer's declaration that a product meets the requirements of relevant EC directives. The EC directives for Framery O, Q and 2Q pods are: Low Voltage Directive (LVD) 2006/95/EC, Electromagnetic Compatibility Directive (EMC) 2004/108/EC, Restriction of Hazardous Substances (RoHS) Directive 2011/65/EU and Ecodesign Directive 2009/125/EC.

## Acoustics

Phone booths and meeting pods can be used to eliminate distractions and increase productivity in the workplace, but this is only achieved if they are actively used. To reach their full potential, pods must be placed close enough to their users. This creates certain requirements especially in terms of sound insulation. The required level of sound insulation for pods, expressed in practical terms, is that they can be placed right next to workstations in an office and people working outside them will not be able to overhear discussions inside. This is especially important in the case of on-demand use of single-person pods.

ISO 23351-1 is a new standard that can be used to measure the level of pods' sound insulation as a whole and to produce a single figure, called speech level reduction, which describes the degree of provided speech privacy. A speech level reduction of 30 dB corresponds with the practical requirement of sound insulation mentioned above. With a lower level of sound insulation, pods should be placed further away from people working outside them.

In addition to sound insulation, interior acoustics of pods are another factor to take into consideration. Poor interior acoustics make it difficult to hear what's being said during phone calls and meetings. This also causes users to raise their voices, which creates another problem in terms of privacy.

Reverberation time is typically used to describe the interior acoustics of a space. Unfortunately, it's not possible to reliably test reverberation time in pods because of their small size. However, the surface area and thickness of absorptive materials inside a pod are good indicators of its acoustics. Also, as with sound insulation, it's important to test pods in practice and make sure that speech sounds natural inside them.



## Fire safety

No flammable materials are used in Framery products. The fire safety of all surface materials, upholstery and acoustics materials of the products are tested and classified by either national or international standards. EN 13501-1 classification for the used materials is the following: acoustic wool is classified B-s1, d0, acoustic felt B-s2, d0 and carpet Cfl-s1. All surface materials have also been tested against ASTM E84 / UL 723 and are classified at least as Class C. Outer frames with laminated surface are IMO certified (French Maritime Authority). Moulded foam used in Tovi stool seat meets CA TB 117:2013 requirements. Fabric meets the performance requirements of BS EN 1021-1 and 1021-2. According to Inspecta, an EU accredited inspection body, there is no need for installing sprinklers in Framery O, Q or 2Q in Europe. Framery has conducted extensive fire testing in US for the products and results suggest that there is no need for installing sprinklers in Framery O, Q and 2Q in North America either. It is still recommended to check the requirements with local AHJ / fire inspector in North America as interpretations may differ.

## Material Safety

We conduct emissions testing for the products every time a major update is planned for Framery products in order to be sure that there aren't any harmful compounds volatilizing from the products such as formaldehydes or VOCs. We want to embrace transparency of the materials we use for our products and thus we have compiled Health Product Declarations® (HPD) for our products. Our HPDs can be found and downloaded for free online from the Health Product Declaration Collaborative public repository.

## Sustainability

Framery's products consist mostly of plywood, steel, glass and acoustic materials. Plywood used in Framery products has a sustainable forestry FSC or PEFC certification. Sound dampening panels are made up to 60% and the felt panels are made up to 80% of recycled PET plastic (e.g. Plastic bottles). Significant part of all steel, aluminum and glass is recycled during their manufacturing processes. 3rd Party Certifier has conducted a Life Cycle Assessment (LCA) and compiled Environmental Product Declarations (EPD) for both Framery O and Framery Q.



# Taking care of you (and your Framery pod)

We at Framery are serious about the happiness and safety of you all! This is why we gathered useful information on how to make people feel safe to return to their workplaces and use their Framery pods mindfully.

Here's how to make a safe workplace the new normal:

## Good hygiene is key

As the World Health Organization states, good hygiene and keeping distance is key in protecting yourself and others. Wash your hands regularly, keep your surroundings clean and stay at home if you're feeling sick. Naturally we encourage you to follow your local health authorities' recommendations!

Please also keep in mind that you can have the pods moved around to adapt to your changed needs. You can have your Framery pods placed so that they are only available to limited number of users, keeping a healthy distance. Place hand sanitizers and bleach wipes at entrance of pods to give people peace of mind.

## Framery cleaning guide

Framery pods can and should be cleaned efficiently on a regular basis. All materials of the pod can be cleaned with disinfection solution. See the Framery Cleaning Guide for easy steps on how to best take care of your Framery pod.

## Social distancing inside the pods

Recommended distance of 6 feet (1,8m) can be maintained between two users in Framery Q and between four

users in Framery 2Q. Remember to practice good hygiene and follow guidelines for the number of people per pod.

## Framery pod ventilation

Framery pods have a proprietary two-phased ventilation system. Air enters the pod through the ceiling and is rapidly pushed down, exiting out of the lower baseboard ventilation channels. When you enter a Framery pod, the fans engage at full capacity.

Framery fans are always turning. They remain at full capacity for 8 minutes after the last user leaves the pod. All the air inside the pod is refreshed several times over before switching back to low voltage mode. Each new user will be greeted with refreshed air every time they enter the pod.

The air circulation inside a Framery pod is multiple times higher than the general recommendation for occupied spaces.

A typical recommendation is 6-8 liters per second (13-17 cubic feet per minute) of ventilation

per person inside a space. The ventilation speed of Framery O is 21,5 l/s (45 CFM), Framery Q is 66 l/s (140 CFM) and Framery 2Q is 121 l/s (256 CFM).

## Framery added safety

All tabletop laminates used in Framery pods are antimicrobial as a standard, but we do offer some added options for high-touch surfaces. Our copper-plated door handle and non-toxic polyester fabrics make good even better and maximize safety.



# Cleaning guide

**Ventilation shaft**  
Vacuum clean the ventilation shaft.

**Exterior**  
Wipe metal body covers.  
Use a mildly alkaline all-purpose detergent for cleaning.

**Glass**  
Clean the glass.  
Standard glass cleaning solution can be used.

**Fabrics (stool & sofas)**  
We use wool in our fabrics. Wool is naturally resistant to dirt. For woolen textiles we recommend dry cleaning or professional cleaning. Alcohol-based disinfectants can be used without damaging the textiles or changing its color. Concentration should be between 70-85%. Avoid chlorine-based and bleach cleanable solutions. We do not recommend washing woolen textiles.

**Carpet**  
Vacuum clean the interiors.

**Frames**

**Table**  
Use a mildly alkaline all-purpose detergent for cleaning. Alcohol-based disinfectants can also be used. (For example: Framery Disinfectant Spray) In extreme circumstances, a 1% chlorine-based solution may be used for table tops. Apply a small amount of the solution to a cloth and wipe the surface gently. Avoid rubbing, as it might lead to discoloration.

**Door handle**  
Use a mildly alkaline all-purpose detergent for cleaning. Alcohol-based disinfectants can also be used. (For example: Framery Disinfectant Spray) In extreme circumstances, a 1% chlorine-based solution may be used for table tops. Apply a small amount of the solution to a cloth and wipe the surface gently. Avoid rubbing, as it might lead to discoloration.

**Felts**  
Vacuum clean the felt.  
Use a mildly alkaline all-purpose detergent for cleaning. Alcohol-based disinfectants can also be used. In extreme circumstances, a 1% chlorine-based solution may be used for the felt. Apply a small amount of the solution to a cloth and wipe the surface gently. Avoid rubbing, as it might lead to discoloration.

**NOTE!** These instructions only apply to furniture provided by Framery.  
**Clean pods make for happier workplaces.**

# Dedicated to sustainability



Framery's sustainability work covers economic, social and environmental responsibility throughout our entire value chain.

Human rights are also fully integrated into everything we do. Since 2018, Framery has been committed to the United Nations Global Compact (UNGC) corporate responsibility initiative and its principles. Our ambition is to make three million people happier by providing our pods and phone booths to workplaces, schools, hospitals and other spaces. And we constantly seek to make our environmental footprint smaller and handprint bigger to be sure we are not just creating happiness today, but happiness also for future generations.

We have defined our sustainability work under three themes:

## 1. Economic value creation

Over the last five years, Framery has grown organically from EUR 1 million to over EUR 106 million. What's our secret to sustainable growth? Well, simply, we don't engage in any funny business. We pay our taxes fair and square; we

do honest deals with our partners and dealers; we pay fair wages and we offer our customers the best possible product.

Furthermore, we have continued to keep all our production at our Tampere headquarters in Finland. This way, we can support our local community by offering jobs in our home municipality of Pirkanmaa.

## 2. Social responsibility

We take special care of our employees, customers and all the people we work with. We have a strong culture backing up our sky-rocket growth and the happiness of our people.

We invest in our people, because we believe that happy Framerians make the best possible products and provide our customers with the best service—in turn making them happy as well. While there are great cultures in many companies, our unique way of working makes Framery a one-of-a-kind. In 2019 we created our own Culture Handbook to tell our story. Our handbook, 'A Culture Fit for Framery', defines our passion and drive to do meaningful things together

and also represents our deep sense of community and appreciation towards others. Our values in the core of our culture are the abilities and practices that we especially appreciate in each other and where we base our decision making on. They are not just hollow phrases – our values create our shared practices, rules and goals. When we recruit new colleagues, consider pay raises or individual growth, we always mirror the actions of the individual to our values.

The values we expect each of us and future colleagues to live by are:

- Respect
- Courage
- Transparent communication
- Impact
- Curiosity
- Good judgment

At Framery we have absolutely zero tolerance for discrimination and inappropriate behavior. We cherish and support different viewpoints and believe that the more diverse spectrum of different views we have, the better decisions we are able to make.

## 3. Environmental efficiency

We are aware of the serious environmental threats that our world is facing; climate change, resource scarcity, loss of biodiversity. This challenging context motivates us to do our part in helping to create a more sustainable world.

The shift towards a circular economy is indispensable. By converting our business models to be more circular, we are future-proofing our business and respecting planetary boundaries at the same time. Framery has paid special attention to better understand its position in circular economy and climate change.

We have undergone Life-Cycle Assessments for all our products and conducted calculations on different scopes of company GHG emissions. In 2019 we participated in the Nordic CIRCit research project.

Framery is committed to the Science Based Targets as it relates to reducing greenhouse gas emissions. This target shows Framery's commitment to the latest climate science that says it is necessary to meet the goals of the Paris Agreement—to limit global warming to well-below 2°C above pre-industrial levels and pursue efforts to limit warming to 1.5°C.

As the first pod manufacturer to receive a verified Environmental Product Declaration (EPD), Framery has always believed in transparency when it comes to the sustainability of our pods. Having committed to disclosing product materials transparently through the Health Product Declaration, we allow customers to know everything that goes into our pods. GREENGUARD certification shows that our products are proven to meet some of the world's most rigorous third-party chemical emissions standards, helping to reduce indoor air pollution and the risk of chemical exposure. ■

## Carbon Footprint During the Pod Life Cycle

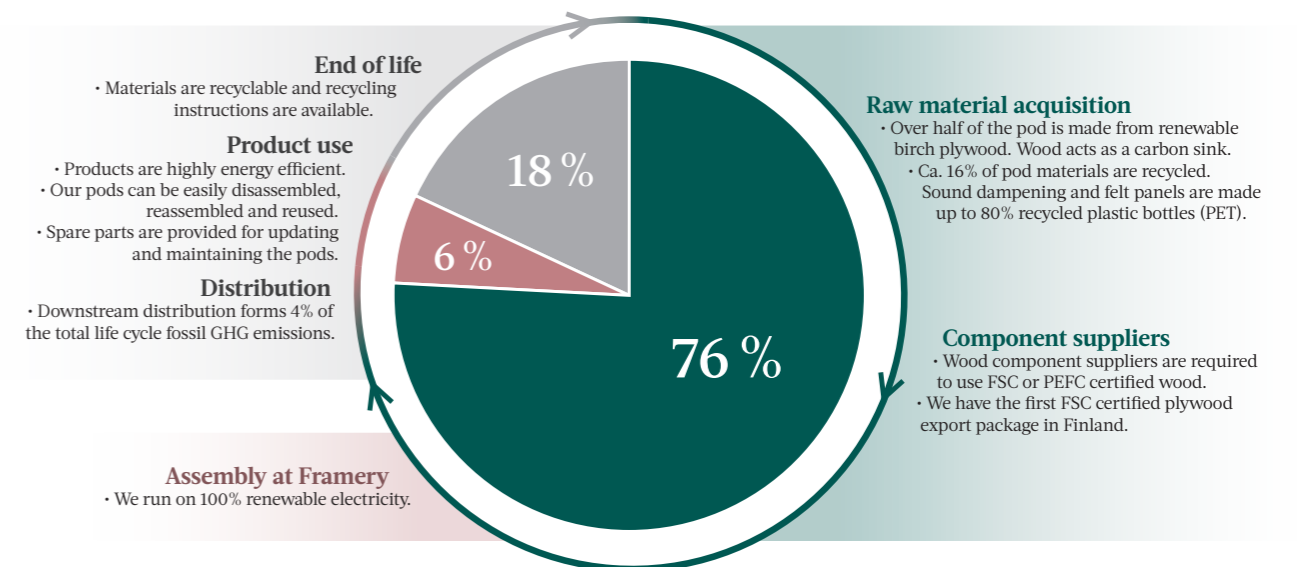

In comparison	Framery O	Framery Q	Framery 2Q
<p>2-PERSON FLIGHT</p> <p>HELSINKI - SAN FRANCISCO - HELSINKI</p> <p>= 2611 CO<sub>2</sub> kg</p>			
▼ CO <sub>2</sub> footprint, kg	1634	2880	3890
▲ CO <sub>2</sub> uptake, kg	1760	2923	3268

Carbon footprint is the amount of fossil greenhouse gas emissions that are released in the whole value chain during the whole product life cycle. Carbon uptake is wood's ability to bind carbon dioxide from the atmosphere. This amount of carbon is stored in the pod as long as it is used. Links to the handprint of the product = positive climate impact that using a product or service has.

# The story of Framery



This is the story of Framery. It was 2010 and there were around a hundred employees working in the same open office space, two of them, including our current CEO who was also one of Framery's founders, had enough of listening to their boss speaking constantly on his phone with a headset. It was basically impossible to concentrate on anything. The two soon came up with a less than polite proposal, that the boss go elsewhere to make his calls. He was quick with a response: **"Well, buy me a phone booth"**. The problem being that there wasn't one on the market, so the only alternative was to make one.

**That day they gave up working for that software company and started to become experts on acoustics and, Framery was born.**

The first booth was ugly and not particularly sound-proof, but the guys had found their calling and realized that many workplaces suffer from the same problem with no solution available.

After years of development, analyzing customer feedback and rigorous trial and error, our sixth generation for phone booth or pod, the Framery O, turned out to be super functional, a silent place to work with superb acoustics and silent ventilation. Initially, as with anything new it was a struggle to sell them, but when people began to use them and their office culture quickly transformed, news began to travel and soon companies such as Microsoft, SAP and Deloitte bought them and loved them. We've sold them in the thousands, and today the Framery O is the world's best selling pod.

Initially we thought we were selling silence – but we were wrong. Together with our customers we saw the bigger picture.

Noise in open offices is a major obstacle to workplace happiness, as a result of constant disruptions from phone calls, ad hoc meetings and discussions. It's hard to recover your concentration when it's broken, it takes time to refocus, you become less productive, less creative and your potential is not fulfilled. You become less happy as a result.

This was our wake-up call. When we removed the noise problem, people quickly became happier. Happy people are more efficient, more creative and produce better work. Happiness then obviously and quickly became our purpose going forward, not only concerning our products but for everything we do.

## Noise in the open office is just one obstacle to happiness.

Work and the way we do it is changing quickly. What was relevant in an industrial context does not apply to information work. What worked in an open-plan office does not work in multipurpose spaces. And whatever we are learning about new digital working methods, will become obsolete as soon as we start working side-by-side with artificial intelligence. So noise reduction is, and will be, just a part of the solution to workplace happiness.

With a strong focus and investment in research, and a commitment to practice what we preach inside our own company, we are determined to find the other parts of the happiness solution, and we intend to be happy while doing it. ■

2010  
Framery founded.

2012  
1st deliveries to other Nordic countries.  
Sweden and Denmark.

2013  
1st deliveries outside Nordics.  
E.g. to Twitter in USA.

2015  
Production starts.

2016  
Framery Inc. founded.

2017  
1st Framery World Conference held.  
Showrooms opened in Tampere and Sweden.

2018  
Equity investor Vaaka Partners buys the majority of Framery.  
Logistics hub started in Michigan, USA.  
Framery products have been sold to all inhabited continents.

2019  
Framery Singapore established.  
Framery Subscribed and online store introduced.

2020  
Framery Japan and Australia established.  
Science Based Target set to reduce greenhouse gas emissions.

2021  
Framery One – the start of a new era.



**framery**  
SERIOUS ABOUT HAPPINESS



WWW.FRAMEYACOUSTICS.COM