

WHASS

— By ITEMDesign Works —
Javier Cuñado



■ **DESCRIPTION**

- ① **Polypropylene (P.P) + 30% F.V. frame**, 5 mm thick, with glass fibre.
- ② Model with or without arms. Model with arms: **polypropylene (P.P) armrests**.
- ③ **Optional seat:** Upholstered with an ergonomic cushion (115-125 kg/m³) in upholstered or PUR
- ④ **Bottom structure:** 24,5 x 12 mm ovale steel tube bars, 1.5 mm thick. Lower polypropylene frame covering the structure.
- ⑤ **Structure** made with cylindrical hot-rolled steel tubes, Ø16mm and e=2 mm, with a 90-micron thick epoxy paint coating.
- ⑥ **End caps** in a graphite grey finish with felt silent pad-anti scratch.



■ **SHELL**

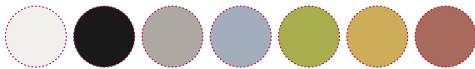

5 mm polypropylene (P.P) with 30% fibreglass in a wide range of colours.

■ **UPHOLSTERED SEAT**



Fabric T Fabric M Fabric D Fabric V

■ **PU SEAT**



■ **STRUCTURE FINISH**



Ø13x2 mm hot-rolled steel tube in a white, black, aluminised or chrome finish.

■ **STACKING**

The 4 legs chairs is designed for the seats to be stacked on top of one another, with the ability to stack **up to 30 chairs in the stacking cart** and **up to 10 chairs in the standard way**. (without an upholstered seat)

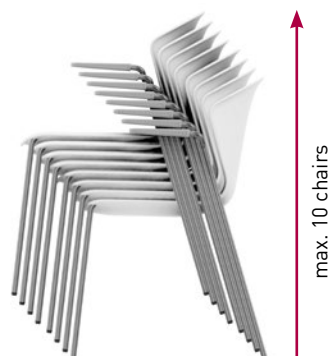

■ **DIMENSIONS**

- Total Height: 813 mm
- Total Width: 517 mm
- Total Depth: 540 mm
- Seat Height: 455 mm or 474 mm with cushioned seat
- Seat Width: 440 mm
- Seat Depth: 400 mm

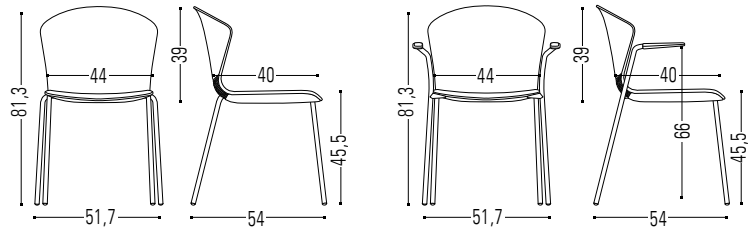

■ **OPTIONAL ACCESSORIES**



Optional removable writing tablet in 3 mm compact laminate; can be placed on the right or left.

Chairs with a writing tablet stack 4 chairs in the standard way.

■ **DESCRIPTION**

- ① **Polypropylene (P.P) + 30% F.V. frame**, 5 mm thick, with glass fibre.
- ② **Model without arms.**
- ③ **Optional seat:** Upholstered with an ergonomic cushion (115-125 kg/m3) in upholstered or PUR
- ④ **Bottom structure:** 24,5 x 12 mm ovale steel tube bars, 1.5 mm thick. Lower polypropylene frame covering the structure.
- ⑤ **Structure** made with cylindrical hot-rolled steel tubes, Ø16mm and e=2 mm, with a 90-micron thick epoxy paint coating.
- ⑥ **End caps** in a graphite grey finish with felt silent pad-anti scratch.



■ **SHELL**

5 mm polypropylene (P.P) with 30% fibreglass.

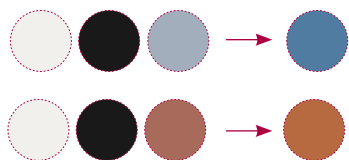

■ **STRUCTURE FINISH**

Ø13x2 mm hot-rolled steel tube in a blue or orange finish.

■ **DIMENSIONS**

- Total Height: 813 mm
- Total Width: 517 mm
- Total Depth: 540 mm

- Seat Height: 455 mm or 474 mm with cushioned seat
- Seat Width: 440 mm
- Seat Depth: 400 mm

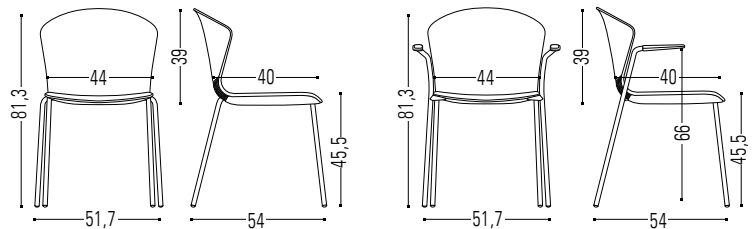

■ **UPHOLSTERED SEAT**

Blue Structure

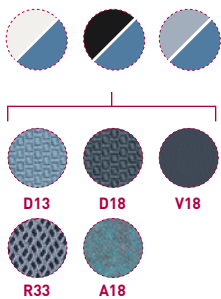

Orange Structure

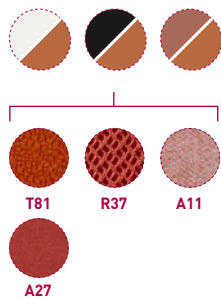

■ **DESCRIPTION**

- ① **Polypropylene (P.P) + 30% F.V. frame**, 5 mm thick, with glass fibre.
- ② **Model without arms.**
- ③ **Optional seat:** Upholstered with an ergonomic cushion (115-125 kg/m³) in upholstered or PUR
- ④ **Bottom structure:** 24,5 x 12 mm ovale steel tube bars, 1.5 mm thick. Lower polypropylene frame covering the structure.
- ⑤ **Structure** made with cylindrical hot-rolled steel tubes, Ø16mm and e=2 mm, with a 90-micron thick epoxy paint coating.
- ⑥ **End caps** in a graphite grey finish with felt silent pad-anti scratch.

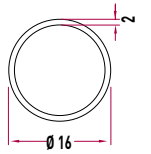

■ **SHELL**



5 mm polypropylene (P.P) with 30% fibreglass in a wide range of colours.

■ **UPHOLSTERED SEAT**



Fabric T Fabric M Fabric D Fabric V

■ **PU SEAT**



■ **STRUCTURE FINISH**



Ø13x2 mm hot-rolled steel tube in a white, black, aluminised or chrome finish.



■ **DIMENSIONS**

- Total Height: 758 mm
- Total Width: 517 mm
- Total Depth: 540 mm
- Seat Height: 400 mm or 419 mm with cushioned seat
- Seat Width: 440 mm
- Seat Depth: 400 mm

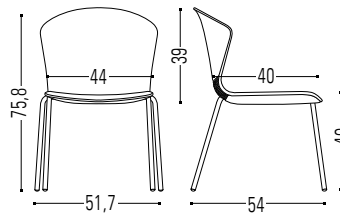

■ **DESCRIPTION**

- ① **Polypropylene (P.P) + 30% F.V. frame**, 5 mm thick, with glass fibre.
- ② Model with or without arms. Model with arms: **polypropylene (P.P) armrests**.
- ③ **Optional seat:** Upholstered with an ergonomic cushion (115-125 kg/m³) in upholstered PUR.
- ④ **Bottom structure:** 24,5 x 12 mm ovale steel tube bars, 1.5 mm thick. Lower polypropylene frame covering the structure.
- ⑤ **Structure** made with cylindrical hot-rolled steel tubes, Ø13mm and e=2 mm, with a 90-micron thick epoxy paint coating.
- ⑥ **End caps** in a graphite grey finish with felt silent pad-anti scratch.

■ **SHELL**



5 mm polypropylene (P.P) with 30% fibreglass in a wide range of colours.

■ **UPHOLSTERED SEAT**



Fabric T Fabric M Fabric D Fabric V

■ **PU SEAT**

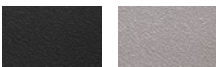

■ **STRUCTURE FINISH**



Ø13x2 mm hot-rolled steel tube in a white, black, aluminised or chrome finish.

■ **OPTIONAL ACCESSORIES**



For **projects of facilities** that require **concatenated joints of the chairs and minimum quantities of 100 units**, consult with **Sales Department**.
Can only be used on armless Cantilever chairs.



Optional removable writing tablet in 3 mm compact laminate; can be placed on the right or left.
Chairs with a writing tablet stack 4 chairs in the standard way.

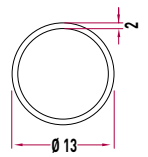

■ **DIMENSIONS**

- Total Height: 813 mm
- Total Width: 517 mm
- Total Depth: 540 mm
- Seat Height: 455 mm or 474 mm with cushioned seat
- Seat Width: 440 mm
- Seat Depth: 400 mm

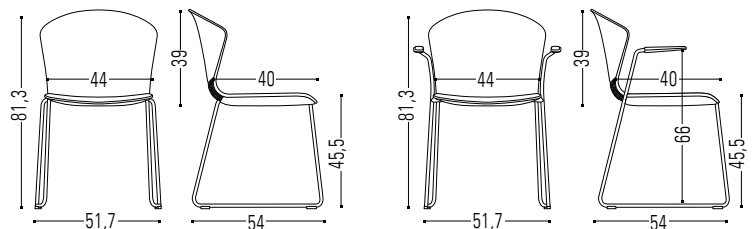

■ **STACKING**

The WHASS cantilever is designed for the seats to be stacked on top of one another, with the ability to stack **up to 30 chairs in the stacking cart and up to 10 chairs in the standard way**. (without an upholstered seat)



■ **DESCRIPTION**

- ① **Polypropylene (P.P) + 30% F.V. frame**, 5 mm thick, with glass fibre.
- ② **Model without arms.**
- ③ **Optional seat:** Upholstered with an ergonomic cushion (115-125 kg/m³) in upholstered or PUR
- ④ **Bottom structure:** 24,5 x 12 mm ovale steel tube bars, 1.5 mm thick. Lower polypropylene frame covering the structure.
- ⑤ **Structure** made with cylindrical hot-rolled steel tubes, Ø13mm and e=2 mm, with a 90-micron thick epoxy paint coating.
- ⑥ Ø13x2 mm hot-rolled steel cylindrical tube **footrest**. Protector for placing feet on chairs with a painted structure.
- ⑦ **End caps** in a graphite grey finish with felt silent pad-anti scratch.

■ **SHELL**



5 mm polypropylene (P.P) with 30% fibreglass in a wide range of colours.

■ **UPHOLSTERED SEAT**



Fabric T Fabric M Fabric D Fabric V

■ **PU SEAT**



■ **STRUCTURE FINISH**



Ø13x2 mm hot-rolled steel tube in a white, black or chrome finish.

■ **DIMENSIONS**

- Total Height: 1120 mm
- Total Width: 517 mm
- Total Depth: 540 mm
- Seat Height: 760 mm or 779 mm with cushioned seat
- Seat Width: 440 mm
- Seat Depth: 400 mm

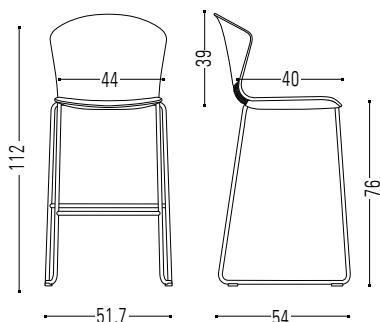

- **Not Stackable**

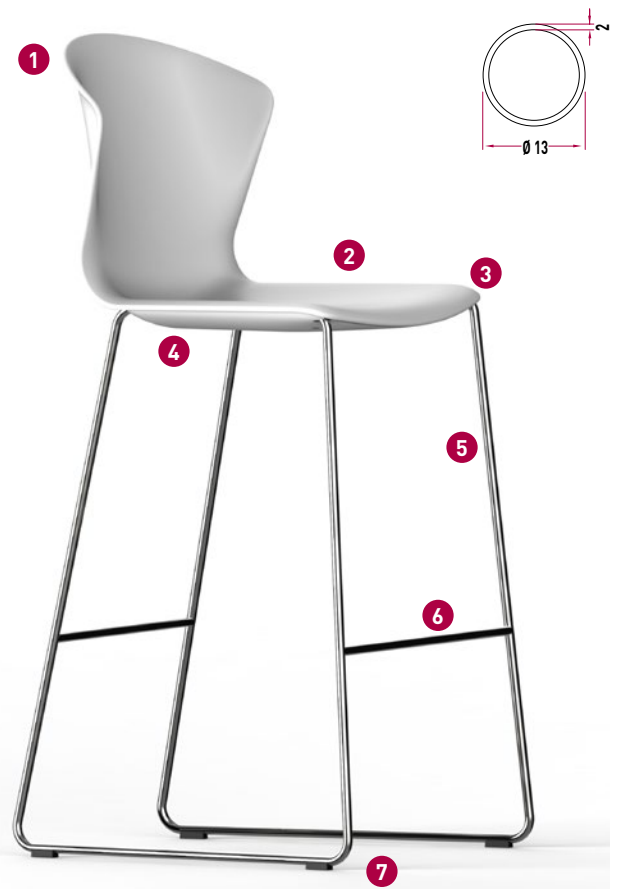

STACKABILITY

WHASS chair is designed to offer a very high stacking level on both models: 4 legs and cantilever frame.

WHASS cantilever frame provides the possibility of stacking up to **30 chairs on the trolley** and up to **10 chairs vertically positioned**. (only without seat pad).

On the other hand, the 4 legs model provides the possibility of stacking up to **30 chairs on the trolley** and up to **10 chairs vertically positioned**. (only without seat pad).

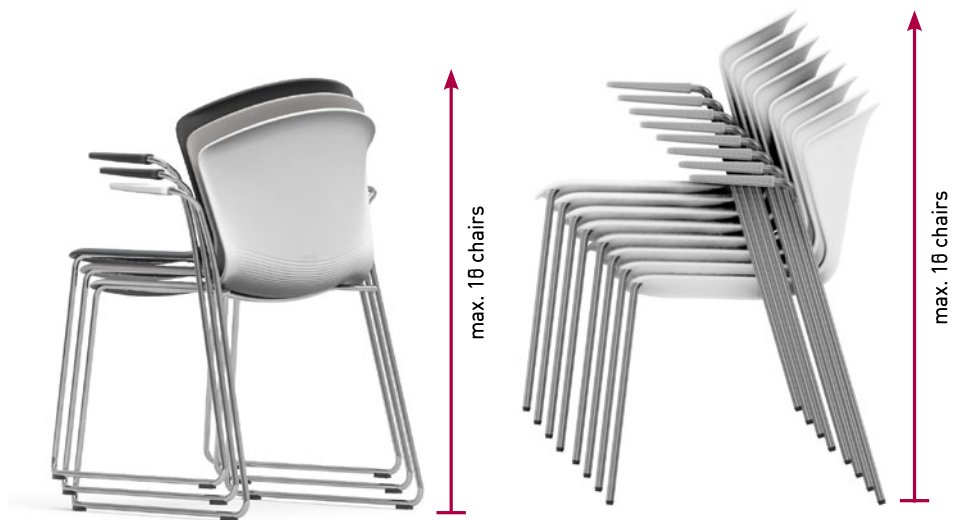

NOTE: We suggest that chrome frames are used on projects where intensive use is required and where stacking/unstacking of chairs is done very often. Nevertheless, you can check with Sales department a special option to have both 4 legs and cantilever frames painted in high-resistant two-coated white paint based on quantities only for projects.

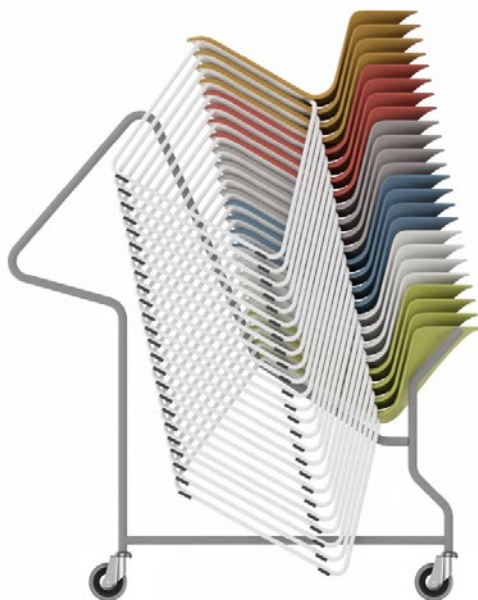

stacking details

		Seat WITHOUT PAD (models with and without arms)		Seat WITH PAD (models with and without arms)	
		Trolley stacking capacity	Vertical stacking capacity	Trolley stacking capacity	Vertical stacking capacity
		Quantity of chairs	Quantity of chairs	Quantity of chairs	Quantity of chairs
4 legs model	With bottom cover	30	10	20	5
	Without bottom cover	30	10	--	--
Cantilever frame	With bottom cover	30	10	20	5
	Without bottom cover	40	10	--	--

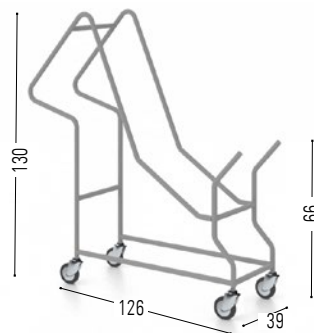

NOTE: Chairs can also be ordered without the under-seat carcass only for Projects and based on quantities to improve the stacking capacity. Please check with **Sales department**.

■ **DESCRIPTION**

- ① **Polypropylene (P.P) + 30% F.V. frame**, 5 mm thick, with glass fibre.
- ② Model without arms.
- ③ **Optional seat:** Upholstered with an ergonomic cushion (115-125 kg/m³) in upholstered or PUR
- ④ **Bottom structure:** Bottom structure: Bottom frame of injected aluminum, which gives the chair greater precision, lightness and recyclability, covering the structure
- ⑤ **Wooden legs** with a conical shape in a natural beech wood or black lacquered finish.
- ⑥ Polypropylene (P.P) **End caps** in black with non-slip felt



■ **SHELL**



5 mm polypropylene (P.P) with 30% fibreglass in a wide range of colours.

■ **UPHOLSTERED SEAT**



Fabric T Fabric M Fabric D Fabric V

■ **PU SEAT**

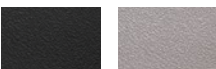

■ **LEGS FINISH**



Wooden legs with a conical shape in a beech wood finish.

■ **DIMENSIONS**

- Total Height: 800 mm
- Total Width: 440 mm
- Total Depth: 480 mm
- Seat Height: 455 mm or 474 mm with cushioned seat
- Seat Width: 440 mm
- Seat Depth: 400 mm

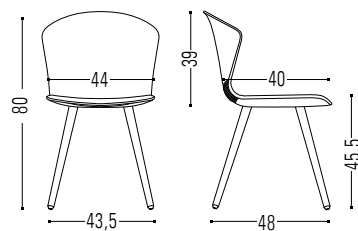

■ **DESCRIPTION**

- ① **Polypropylene (P.P) + 30% F.V. frame**, 5 mm thick, with glass fibre.
- ② Model without arms.
- ③ **Optional seat:** Upholstered with an ergonomic cushion (115-125 kg/m³) in upholstered or PUR
- ④ **Bottom structure:** Bottom structure: Bottom frame of injected aluminum, which gives the chair greater precision, lightness and recyclability, covering the structure
- ⑤ **Wooden legs** with a conical shape in a natural beech wood or black lacquered finish.
- ⑥ Ø13x2 mm hot-rolled steel cylindrical tube **footrest**. Black Finish
- ⑦ Polypropylene (P.P) **End caps** in black with non-slip felt

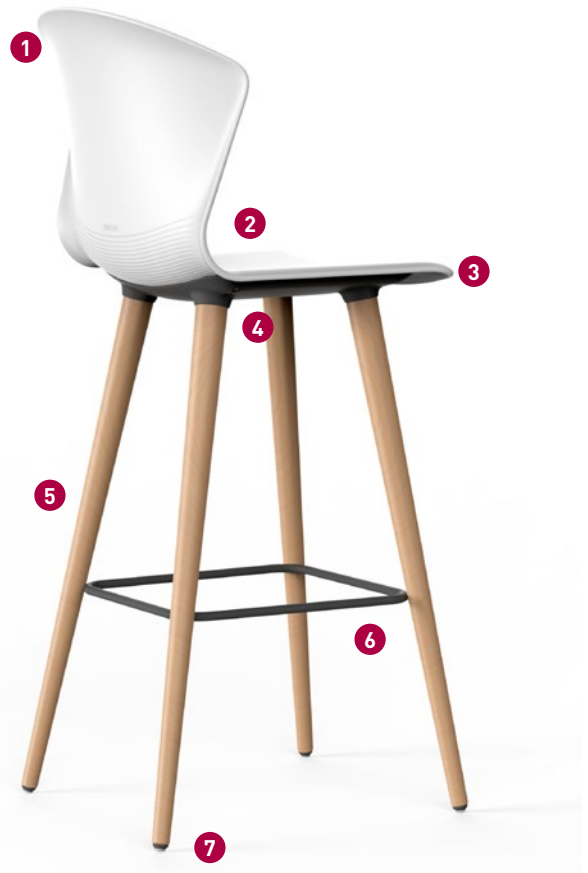

■ **SHELL**



5 mm polypropylene (P.P) with 30% fibreglass in a wide range of colours.

■ **UPHOLSTERED SEAT**



Fabric T Fabric M Fabric D Fabric V

■ **PU SEAT**



■ **LEGS FINISH**



Wooden legs with a conical shape in a beech wood finish.

■ **DIMENSIONS**

- Total Height: 1120 mm
- Total Width: 517 mm
- Total Depth: 540 mm
- Seat Height: 760 mm or 779 mm with cushioned seat
- Seat Width: 440 mm
- Seat Depth: 400 mm

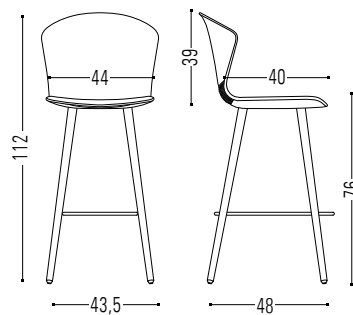

■ **DESCRIPTION**

- ① **Polypropylene (P.P) + 30% F.V. frame**, 5 mm thick, with glass fibre.
- ②
- ③ Model without arms.
- Optional seat:** Upholstered with an ergonomic cushion (115-125 kg/m³) in upholstered or PUR
- ④ **Bottom structure:** Bottom structure: Bottom frame of injected aluminum, which gives the chair greater precision, lightness and recyclability, covering the structure .
- ⑤
- ⑥ **Gas lift**
- ⑦ 5-spoke rotating **base** made of polyamide with fibreglass.
Standard silent **castors** Optional hole, antistatic or auto-brake castors.



■ **SHELL**



5 mm polypropylene (P.P) with 30% fibreglass in a wide range of colours.

■ **UPHOLSTERED SEAT**



Fabric T Fabric M Fabric D Fabric V

■ **PU SEAT**



■ **BASE**



Polyamide Base - Ø67.5 cm

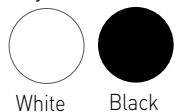

White Black

■ **DIMENSIONS**

- Total Height: 870 -970 mm
- Total Width: 640 mm
- Total Depth: 640 mm
- Seat Height: 420-530 mm or 439-549 mm with cushioned seat
- Seat Width: 440 mm
- Seat Depth: 400 mm

■ **CASTORS AND CAPS**

Standard Castors



Standard

Auto-breaking castors



Optional

Auto-breaking Hole castors



Anti-static castors



Polypropylene caps

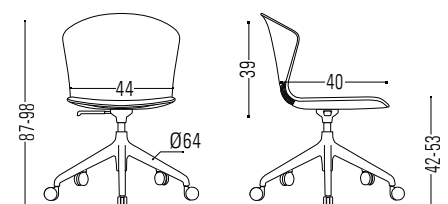

■ **DESCRIPTION**

- ① **Polypropylene (P.P) + 30% F.V. frame**, 5 mm thick, with glass fibre.
- ② Model without arms.
- ③ **Optional seat:** Upholstered with an ergonomic cushion (115-125 kg/m³) in upholstered or PUR
- ④ **Bottom structure:** Bottom structure: Bottom frame of injected aluminum, which gives the chair greater precision, lightness and recyclability, covering the structure
- ⑤ **Gas lift**
- ⑥ Ø18 x 1.5mm chrome steel **footrest** ring, 1.5 mm thick.
- ⑦ 5-spoke rotating **base** 5-spoke rotating made of polyamide with fibreglass.
- ⑧ Inverted auto-brake **castors**. Optional polypropylene caps.



■ **SHELL**

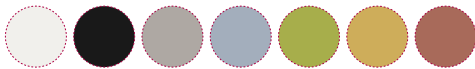

5 mm polypropylene (P.P) with 30% fibreglass in a wide range of colours.

■ **UPHOLSTERED SEAT**



Fabric T Fabric M Fabric D Fabric V

■ **PU SEAT**



■ **BASE**



Polyamide Base - Ø67.5 cm



Black

■ **CASTORS AND CAPS**

INVERTED AUTO-BREAK CASTORS



Standard

POLYPROPYLENE GLIDES



Optional

■ **DIMENSIONS**

- Total Height: 1065-1225 mm
- Total Width: 675 mm
- Total Depth: 675 mm
- Seat Height: 685-845 mm or 704-864 mm with cushioned seat
- Seat Width: 440 mm
- Seat Depth: 400 mm

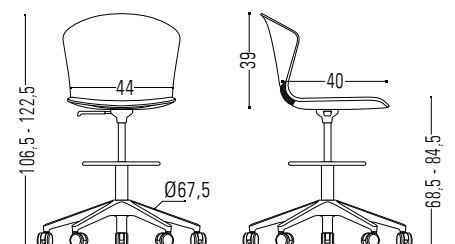

■ **DESCRIPTION**

- ① **Polypropylene (P.P) + 30% F.V. frame**, 5mm thick, with glass fibre.
- ②
- ③ Model without arms.
- Optional seat:** Upholstered with an ergonomic cushion (115-125 kg/m³) in upholstered or PUR
- ④ **Bottom structure:** Bottom structure: Bottom frame of injected aluminum, which gives the chair greater precision, lightness and recyclability, covering the structure
- ⑤
- ⑥ **Gas lift**
4-spoke rotating **base** made of injected aluminium.
- ⑦ **Standard silent hole castors**



■ **SHELL**

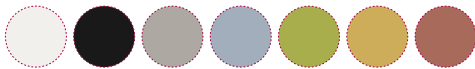

5 mm polypropylene (P.P) with 30% fibreglass in a wide range of colours.

■ **UPHOLSTERED SEAT**



Fabric T Fabric M Fabric D Fabric V

■ **PU SEAT**

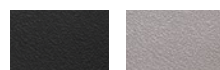

■ **BASE**



Aluminium injection base - Ø69 cm



White Black

■ **DIMENSIONS**

- Total Height: 790 -850 mm
- Total Width: 690 mm
- Total Depth: 690 mm
- Seat Height: 425-485 mm or 443-504 mm with cushioned seat
- Seat Width: 440 mm
- Seat Depth: 400 mm

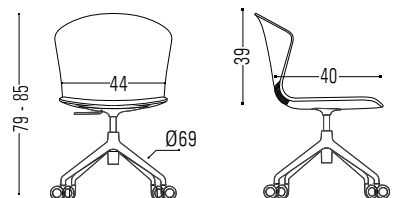

■ **DESCRIPTION**

- ① **Polypropylene (P.P) + 30% F.V. frame**, 5mm thick, with glass fibre.
- ②
- ③ Model without arms.
- ④ **Optional seat:** Upholstered with an ergonomic cushion (115-125 kg/m3) in upholstered or PUR
- ⑤ **Bottom structure:** Bottom structure: Bottom frame of injected aluminum, which gives the chair greater precision, lightness and recyclability, covering the structure
- ⑥ **Swivel seat**
- ⑦ 4-spoke rotating **base** made of injected aluminium.
Black non-slip **rubber pad**



■ **SHELL**

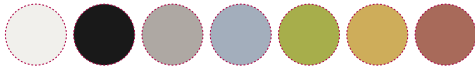

5 mm polypropylene (P.P) with 30% fibreglass in a wide range of colours.

■ **UPHOLSTERED SEAT**



Fabric T Fabric M Fabric D Fabric V

■ **PU SEAT**



■ **BASE**



Aluminium injection base - Ø69 cm



White Black

■ **DIMENSIONS**

- Total Height: 820 mm
- Total Width: 690 mm
- Total Depth: 690 mm
- Seat Height: 460 mm or 479 mm with cushioned seat
- Seat Width: 440 mm
- Seat Depth: 400 mm

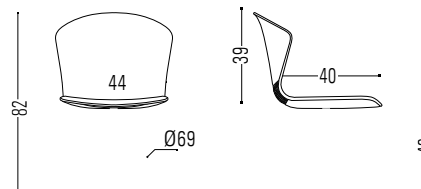

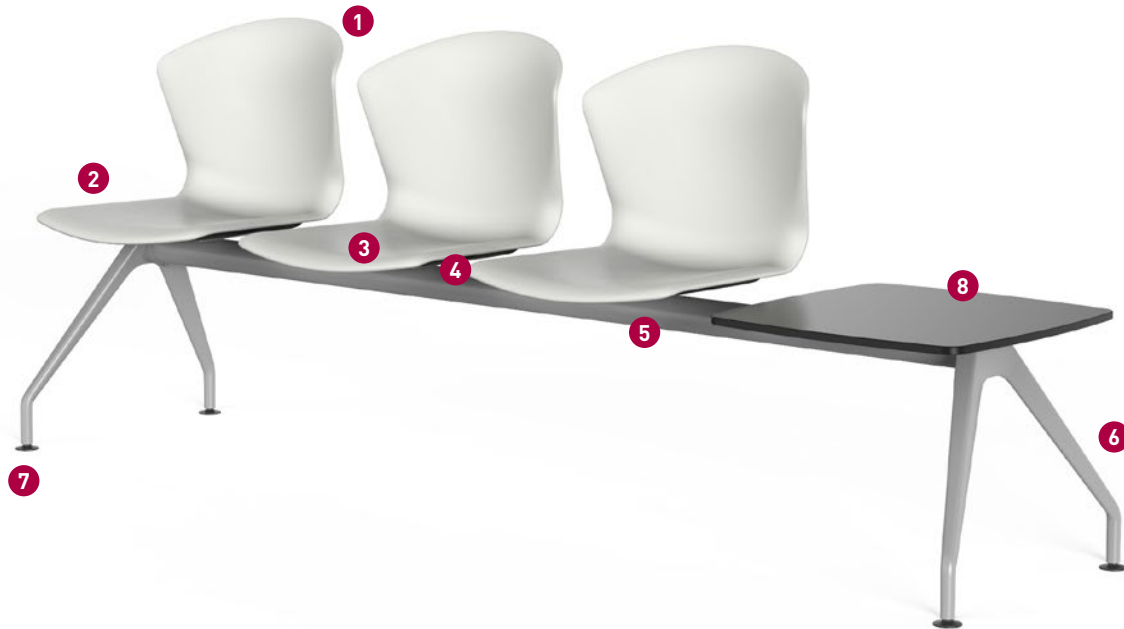

■ **DESCRIPTION**

- ① Polypropylene (P.P) + 30% F.V. frame, 5 mm thick, with glass fibre .
- ② Model without arms.
- ③ **Optional seat:** Upholstered with an ergonomic cushion (115-125 kg/m3) in upholstered or PUR
- ④ **Bottom structure:** Bottom structure: Bottom frame of injected aluminum, which gives the chair greater precision, lightness and recyclability, covering the structure
- ⑤ **Lower steel tube structural beam,** 60 x 3 mm-thick circular section
- ⑥ **Injected aluminium legs** with a 90-micron thick epoxy paint coating
- ⑦ 3 mm thick polypropylene (P.P) **end caps** in a black finish.
- ⑧ **Optional C. Laminate table** in white or black finish - 13 mm thick

■ **SHELL**



5 mm polypropylene (P.P) with 30% fibreglass in a wide range of colours.

■ **UPHOLSTERED SEAT**



Fabric T Fabric M Fabric D Fabric V

■ **PU SEAT**



■ **STRUCTURE FINISH**



Aluminium injection legs



White Silver Black

■ **DIMENSIONS**

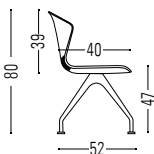

- Total Height: 800 mm
- Total Width: según modelos
- Total Depth: 520 mm
- Seat Height: 455 mm or 474 mm with cushioned seat
- Seat Width: 440 mm
- Seat Depth: 400 mm

Model 3 posts

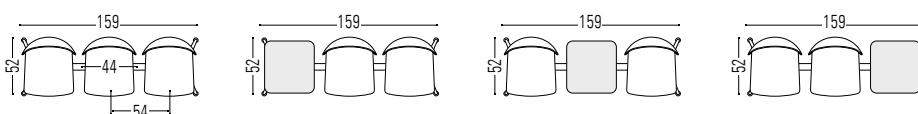

Model 4 posts

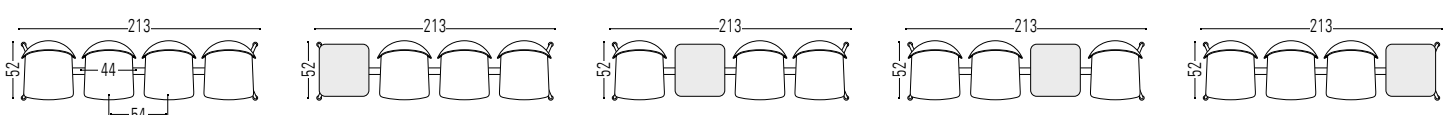

Model with seats



Model 3 posts

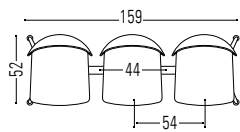

Model 4 posts

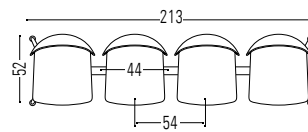

Model with seats with auxiliary table



Model 3 posts

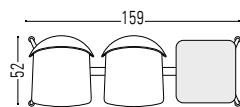
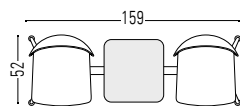
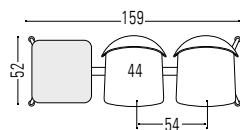

Model 4 posts

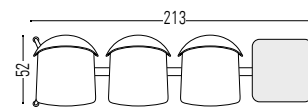
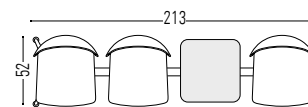
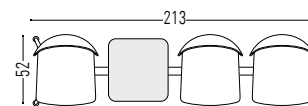
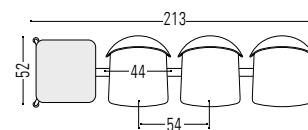

■ Available combinations for the following models:

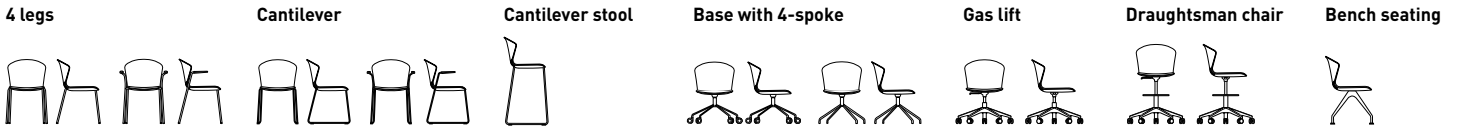

White Frame

- White arms
- White lower cover
- Structure - Any finish



Black Frame

- Black arms
- Black lower cover
- Structure - Any finish



**Blue/Grey/Dark Orange/
Pistachio/Mustard**

- White arms
- White lower cover
- Structure - White finish



**Blue/Grey/Dark Orange/Pistachio/
Mustard**

- Black arms
- Black lower cover
- Structure - Black, Silver, Chrome, Blue or Orange finish

■ Available combinations for the following models:



Frame: Any finish

- Black lower cover
- Structure / Base - Any finish



MATERIALS

Maximum use of materials to eliminate and minimize scraps. Use of recyclable and recycled materials in those components that do not affect the functionality and durability.

Metal legs: **28,10%**
 Cantilever stool: **34,41%**
 Wood legs: **50,09%**
 RECYCLED MATERIALS



PRODUCTION

Maximum optimization of energy use. Minimal environmental impact. Last generation technological systems. Zero discharge of wastewater. No VOC coatings. Processes free of heavy metals, phosphates, OC and COD.

100%
 RECYCLABLE ALUMINIUM, STEEL & WOOD



TRANSPORT

Detachable systems. Volumes that facilitate the optimization of space. Maximum reduction of energy consumption by transport.

100%
 RECYCLABLE PACKAGE AND THINNER FREE



USE

Quality and warranty. Long lasting. Replacements available.

EASY
 TO CLEAN AND MAINTAIN



DISPOSAL

Waste reduction. Supplier-manufacturer packaging reuse system. Components are easy to be separated. Inks in packaging are water-based, without solvents.

Metal legs: **49,71%**
 Cantilever stool: **54,08%**
 Wood legs: **50,34%**
 RECYCLABLE MATERIALS

■ **CERTIFICATES AND REFERENCES**

The different programmes get points in different environmental categories to get the LEED certificate (sustainability, material and resources, water, energy and atmosphere, inner environment quality, innovation and design).



The mark of responsible forestry



EN ISO 14006:2011
 ECODESIGN Certificate



UNE-EN ISO 9001:2008
 ISO 9001 Certificate



UNE-EN ISO 14001:2004
 ISO 14001 Certificate



ACTIU TECHNOLOGY PARK
 LEED® PLATINUM certified by USGBC
 Leadership in Energy & Environmental Design
 LEED® Gold certified 2011 - LEED® Platinum certified 2017

■ **STANDARDS**

Confident office chair. Standard applied

- **UNE-EN 16139:13.** Furniture. Resistance, long lasting, security. Requirements for non domestic use seating.
- **NF P92-507:2004.** Certificate of reaction to fire. Group M2 (Only for projects)
- **UNE EN ISO 14006: 2019.** Environmental management system. Guidelines for incorporating ecodesign.