



# I.AM

Specification Guide

# I.AM

I.AM is a totally flexible and versatile table base that provides a complete family of product options for the commercial environment.

# I.AM

Round/Square

6 – 10



Meeting Tables

11 – 13



Multi-Leg

14 – 15

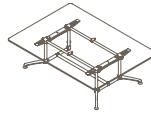

Folding

16

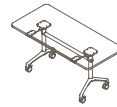

Features

17 – 18

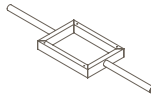

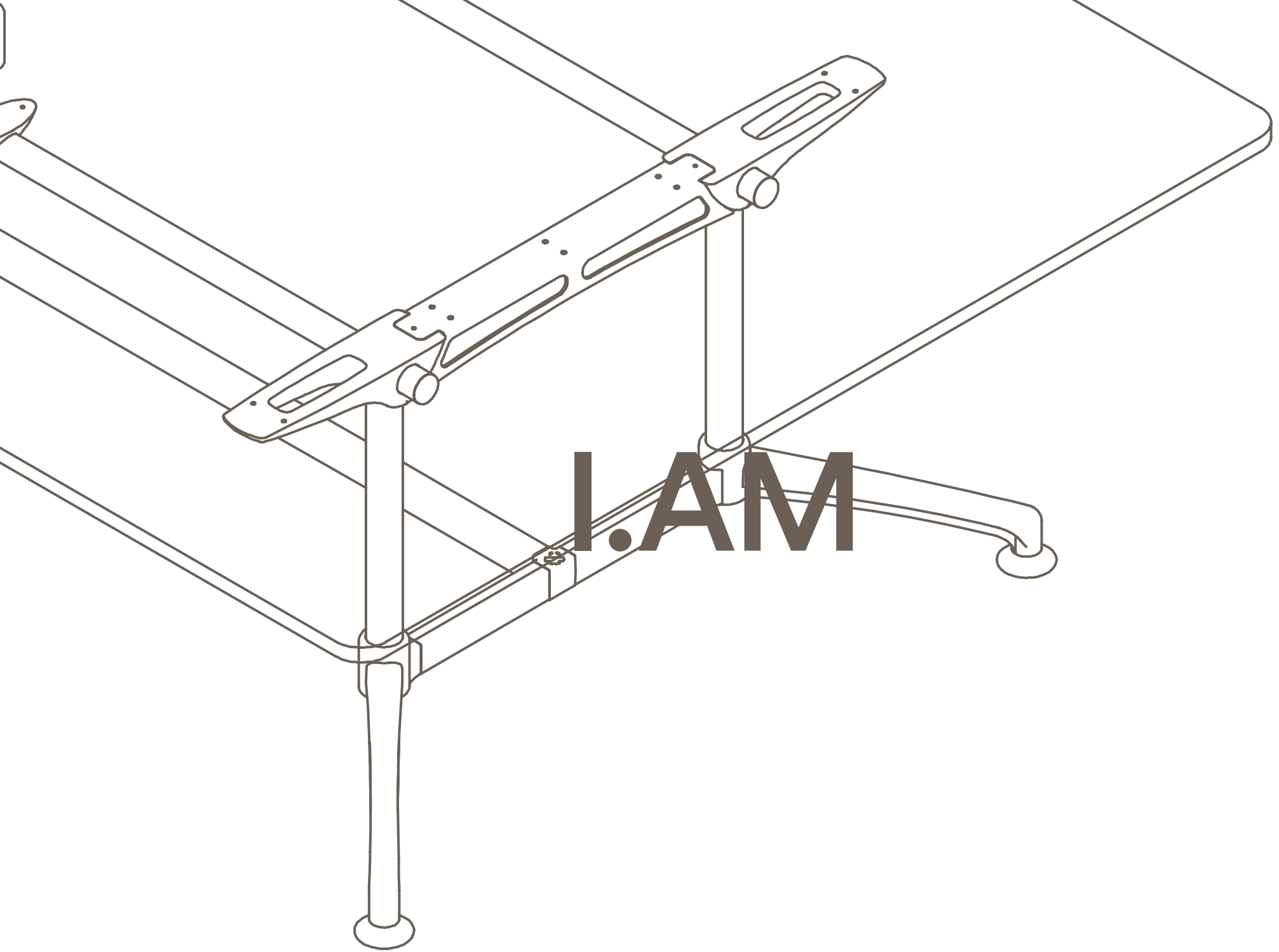

**I.A.M.**

# Multi-Leg Finishes

## 1. Frame Finishes

Standard I.AM frame finishes include black or chrome legs with a polished foot. I.AM is also available in our current season powdercoat colours listed, with custom colour optional.

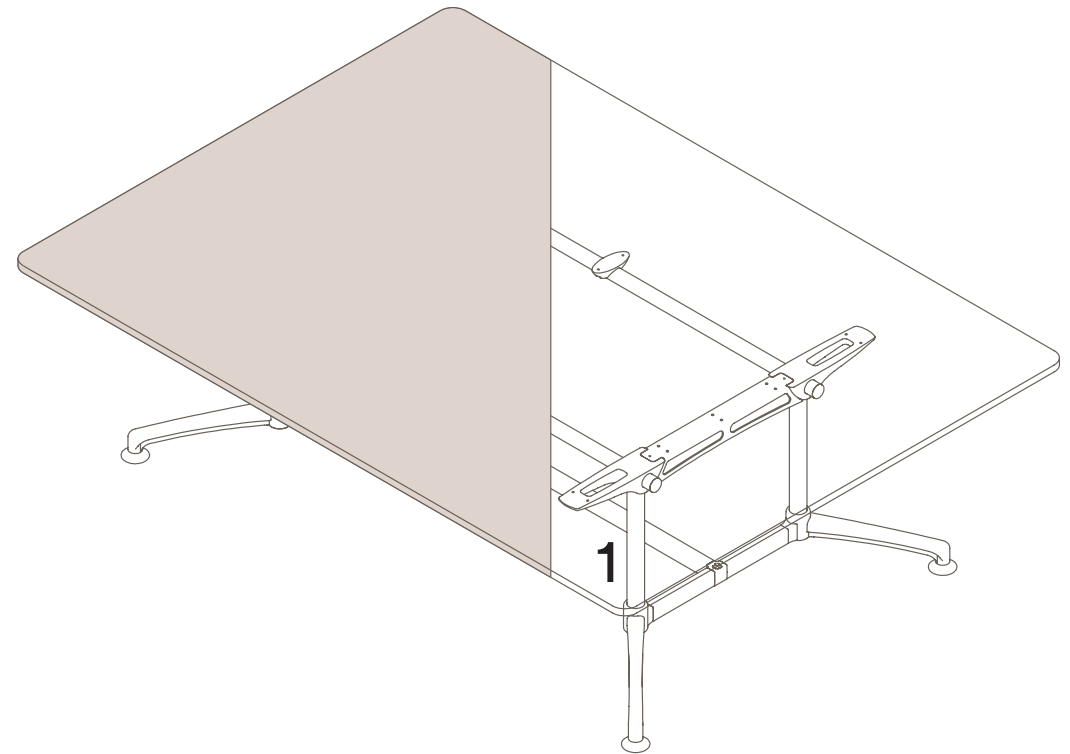
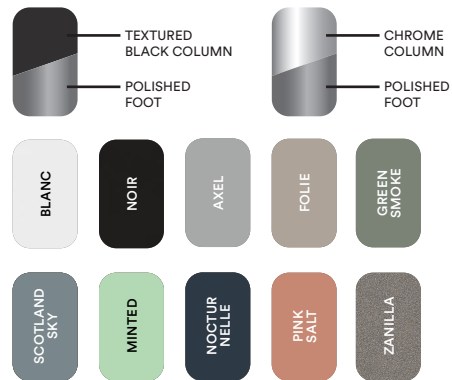

Colours are representative only, please check with your Thinking Works consultant to view samples of any specific colour.

# Tables

## Round / Square

### Materials Information

#### Leg Finish

Steel Leg Column

- a. Textured Black (standard)
- b. Chrome (standard)
- c. Blanc
- d. Noir
- e. Axel
- f. Folie
- g. Green Smoke
- h. Scotland Sky
- i. Minted
- j. Nocturnelle
- k. Pink Salt
- l. Zanita

### I-1020

### 720 (standard Height)

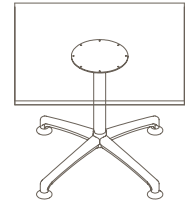
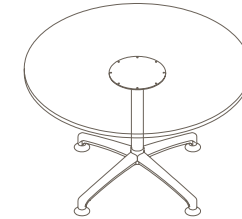
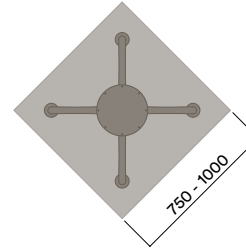
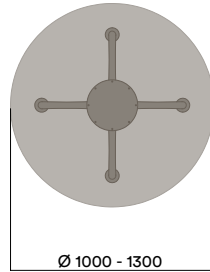

#### Foot Finish

Aluminium Foot

- a. Polished (standard)
- b. Powdercoat (to match column)

#### Frame Finish

Steel Top Horn

- a. Black Powdercoat

### I-1021 Castors

### 720 (standard Height)

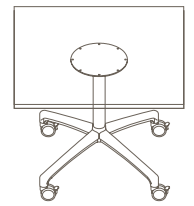
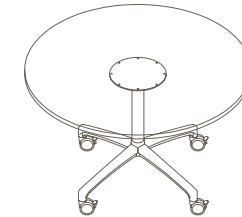
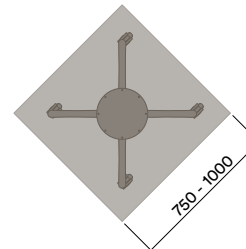
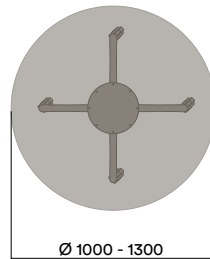

\* Maximum Custom Height 1000mm on Glides  
900mm on Castors

Maximum inc. worktop 40kg  
Maximum Point Load 50kg  
Seats 4

# Tables

## Round / Square

### Materials Information

#### Leg Finish

Steel Leg Column

- a. Textured Black (standard)
- b. Chrome (standard)
- c. Blanc
- d. Noir
- e. Axel
- f. Folie
- g. Green Smoke
- h. Scotland Sky
- i. Minted
- j. Nocturnelle
- k. Pink Salt
- l. Zanita

### I-1025 Folding

### 720 (standard Height)

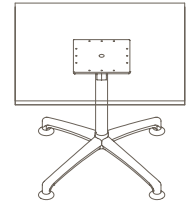
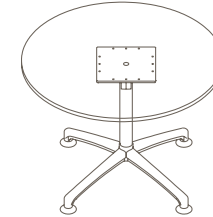
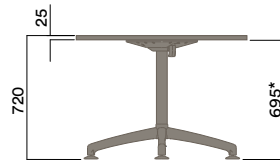
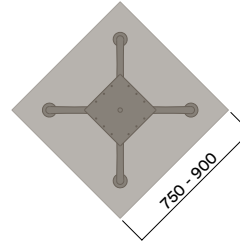
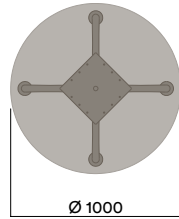

#### Foot Finish

Aluminium Foot

- a. Polished (standard)
- b. Powdercoat (to match column)

### I-1026 Folding on Castors

### 720 (standard Height)

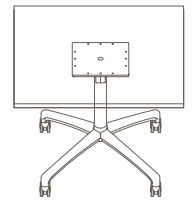
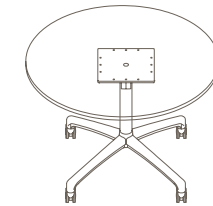
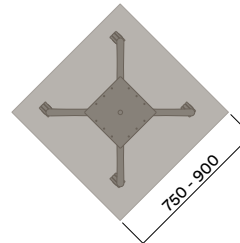
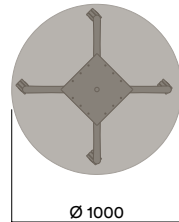

- \* Maximum Custom Height 1000mm on Glides  
900mm on Castors
- Maximum inc. worktop 40kg
- Maximum Point Load 50kg
- Seats 4

# Tables

## Round / Square

### Materials Information

#### Leg Finish

Steel Leg Column

- a. Textured Black (standard)
- b. Chrome (standard)
- c. Blanc
- d. Noir
- e. Axel
- f. Folie
- g. Green Smoke
- h. Scotland Sky
- i. Minted
- j. Nocturnelle
- k. Pink Salt
- l. Zanita

### I-1030

### 720 (standard Height)

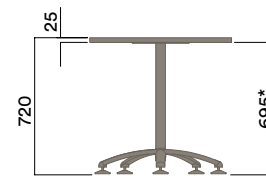
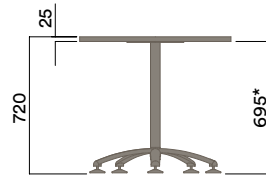
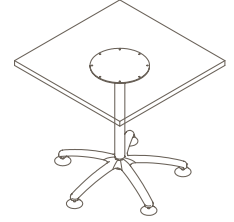
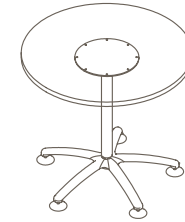
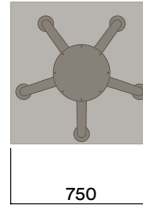
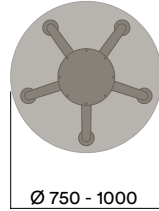

#### Foot Finish

Aluminium Foot

- a. Polished (standard)
- b. Powdercoat (to match column)

#### Frame Finish

Steel Top Horn

- a. Black Powdercoat

### I-1031 Castors

### 720 (standard Height)

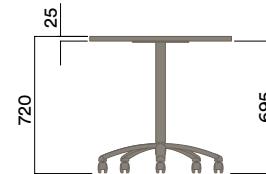
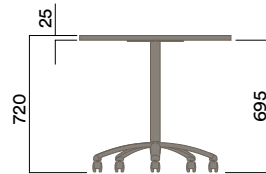
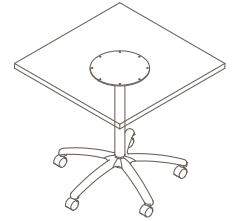
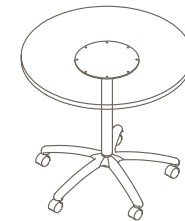
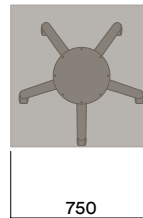
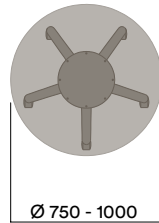

- \* Maximum Custom Height 695mm
- Maximum inc. worktop 20kg
- Maximum Point Load 30kg
- Seats 4



# Tables

## Round / Square

### Materials Information

#### Leg Finish

Steel Leg Column

- a. Textured Black (standard)
- b. Chrome (standard)
- c. Blanc
- d. Noir
- e. Axel
- f. Folie
- g. Green Smoke
- h. Scotland Sky
- i. Minted
- j. Nocturnelle
- k. Pink Salt
- l. Zanita

#### Foot Finish

Aluminium Foot

- a. Polished (standard)
- b. Powdercoat (to match column)

#### Frame Finish

Steel Top Horn

- a. Black Powdercoat

### I-1032 Castors

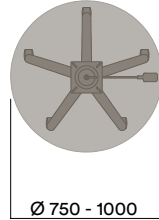

### Gas Lift Height Adjustable

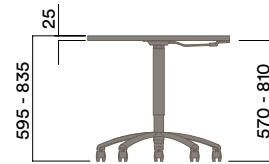
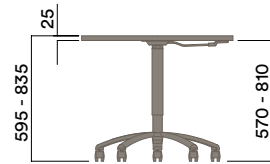
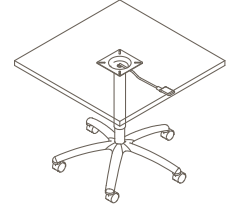
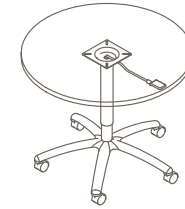
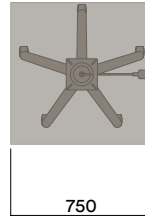

### I-1033

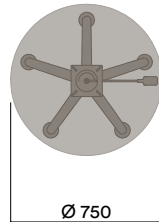

### Gas Lift Height Adjustable

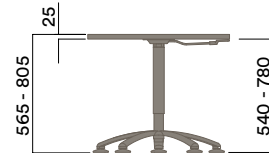
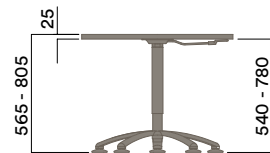
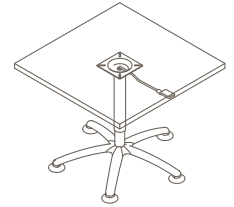
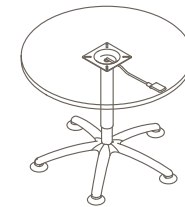
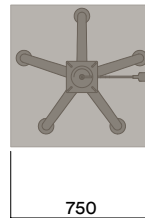

Maximum inc. worktop 20kg  
 Maximum Point Load 30kg  
 Seats 4

# Tables

## Round / Square

### Materials Information

#### Leg Finish

Steel Leg Column

- a. Textured Black (standard)
- b. Chrome (standard)
- c. Blanc
- d. Noir
- e. Axel
- f. Folie
- g. Green Smoke
- h. Scotland Sky
- i. Minted
- j. Nocturnelle
- k. Pink Salt
- l. Zanilla

### I-1035 Folding

### 720 (standard Height)

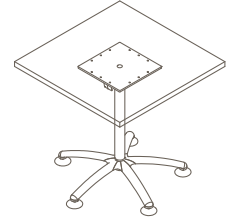
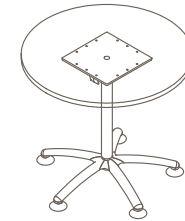
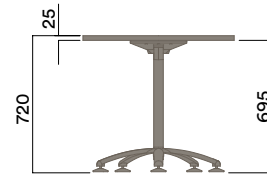
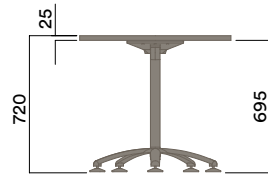
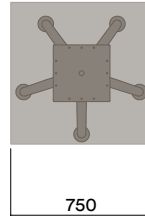
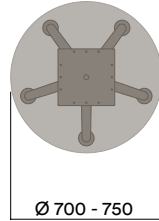

#### Foot Finish

Aluminium Foot

- a. Polished (standard)
- b. Powdercoat (to match column)

### I-1036 Folding on Castors

### 720 (standard Height)

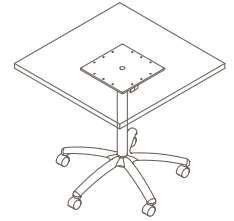
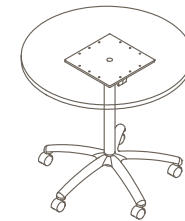
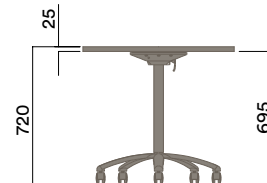
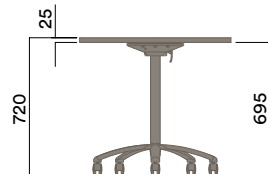
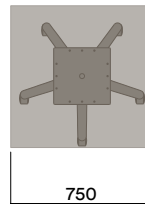
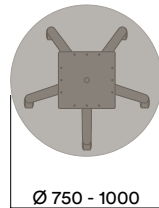

Maximum inc. worktop 20kg  
 Maximum Point Load 30kg  
 Seats 4

# Tables

## Rectangle

### Materials Information

#### Leg Finish

Steel Leg Column

- a. Textured Black (standard)
- b. Chrome (standard)
- c. Blanc
- d. Noir
- e. Axel
- f. Folie
- g. Green Smoke
- h. Scotland Sky
- i. Minted
- j. Nocturnelle
- k. Pink Salt
- l. Zanilla

I-1000, I-1001, I-1002

720 (standard Height)

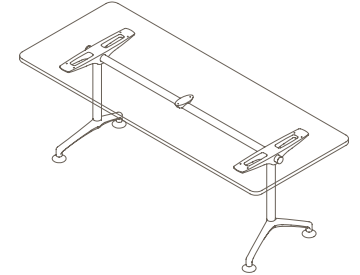
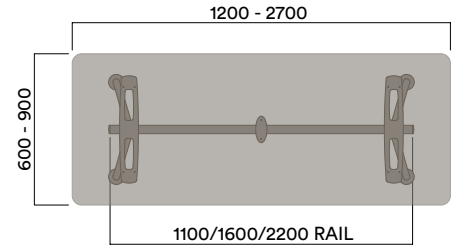

#### Foot Finish

Aluminium Foot

- a. Polished (standard)
- b. Powdercoat (to match column)

#### Frame Finish

Polished Aluminium Top Horn  
Steel Black Powdercoat Rails

I-1010, I-1011, I-1012

720 (standard Height)

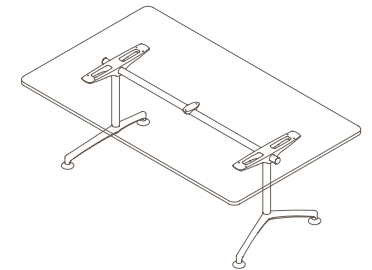
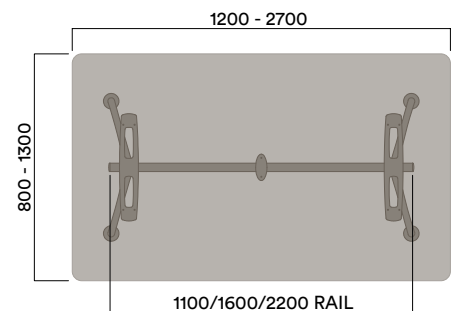

- \* Maximum Custom Height 1000mm on Glides  
900mm on Castors
- Maximum inc. worktop 100kg
- Maximum Point Load 50kg
- Seats 4-6

# Tables

## Rectangle

### Materials Information

#### Leg Finish

Steel Leg Column

- a. Textured Black (standard)
- b. Chrome (standard)
- c. Blanc
- d. Noir
- e. Axel
- f. Folie
- g. Green Smoke
- h. Scotland Sky
- i. Minted
- j. Nocturnelle
- k. Pink Salt
- l. Zanita

#### Foot Finish

Aluminium Foot

- a. Polished (standard)
- b. Powdercoat (to match column)

#### Frame Finish

Polished Aluminium Top Horn  
Steel Black Powdercoat Rails

### I-1040

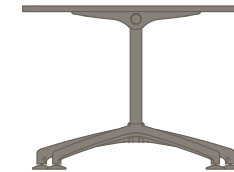
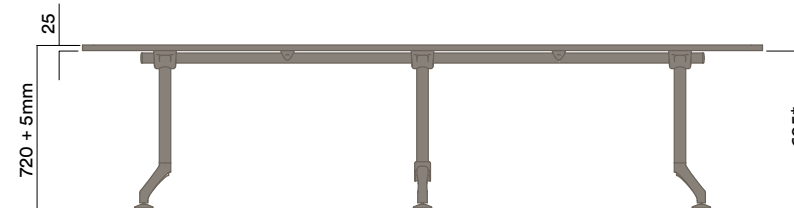
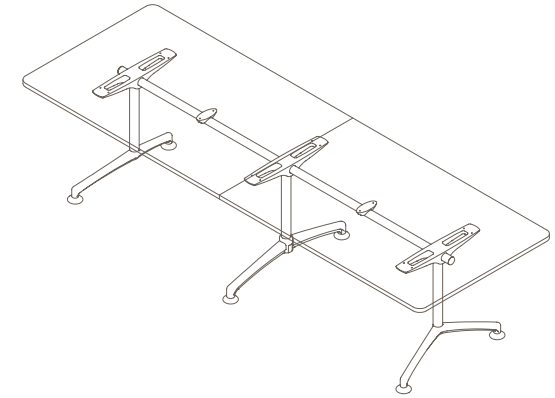
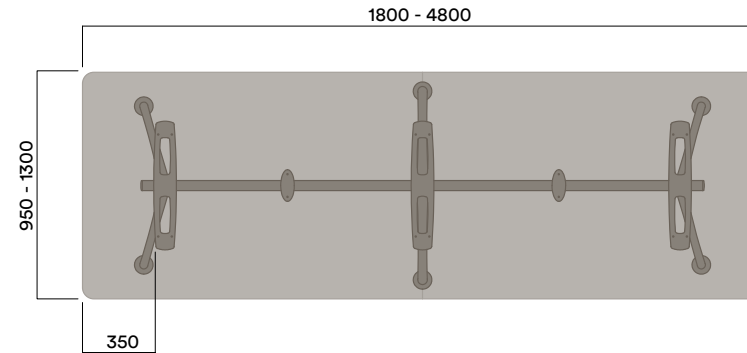

### I-1041

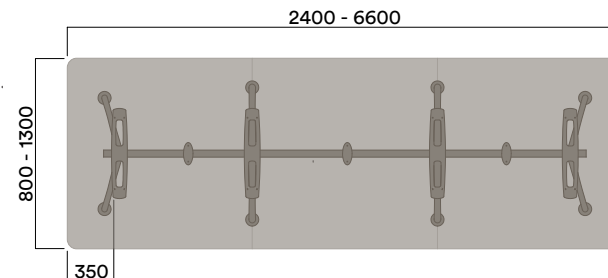

* Maximum Custom Height	1000mm
Maximum inc. worktop	130kg
Maximum Point Load	50kg
Seats	6-18

# Tables Boatshape

## Materials Information

### Leg Finish

Steel Leg Column

- a. Textured Black (standard)
- b. Chrome (standard)
- c. Blanc
- d. Noir
- e. Axel
- f. Folie
- g. Green Smoke
- h. Scotland Sky
- i. Minted
- j. Nocturnelle
- k. Pink Salt
- l. Zanilla

### Foot Finish

Aluminium Foot

- a. Polished (standard)
- b. Powdercoat (to match column)

### Frame Finish

Polished Aluminium Top Horn  
Steel Black Powdercoat Rails

I-1044

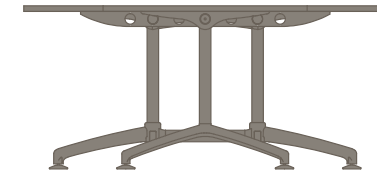
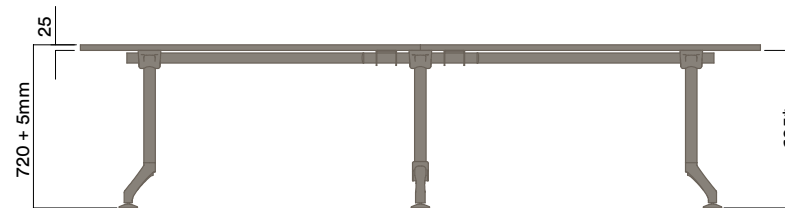
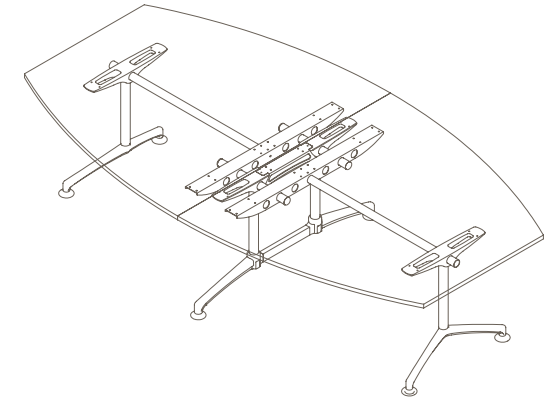
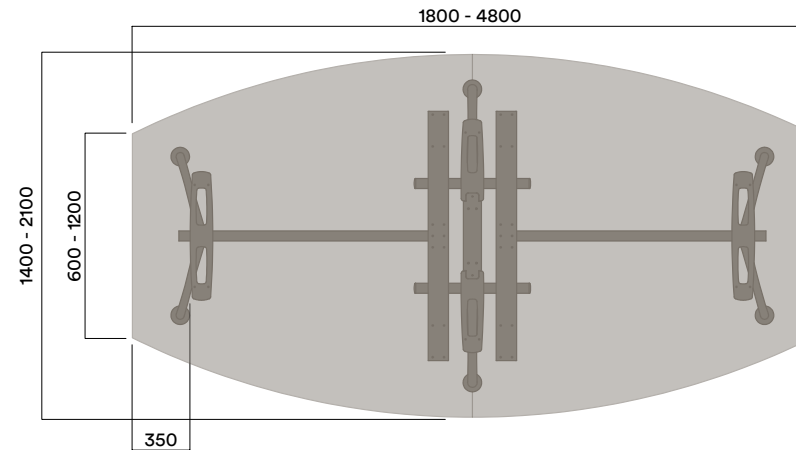

I-1046

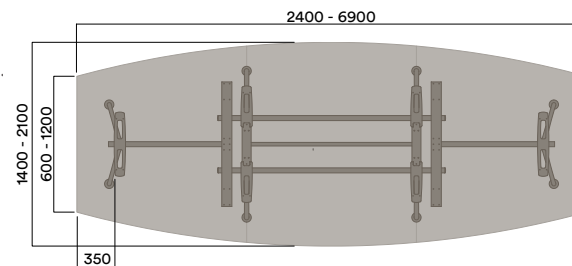

\* Maximum Custom Height 1000mm  
Maximum inc. worktop 160kg  
Maximum Point Load 50kg  
Seats 6-18

# Multi-Leg Round/Square

## Materials Information

I-1070

### Leg Finish

Steel Leg Column and Lower Frame

- a. Textured Black (standard)
- b. Chrome (standard)
- c. Blanc
- d. Noir
- e. Axel
- f. Folie
- g. Green Smoke
- h. Scotland Sky
- i. Minted
- j. Nocturnelle
- k. Pink Salt
- l. Zanilla

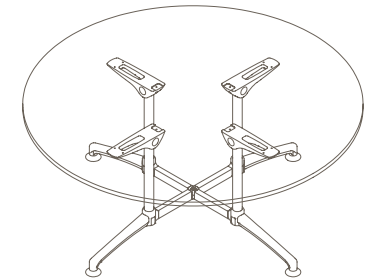
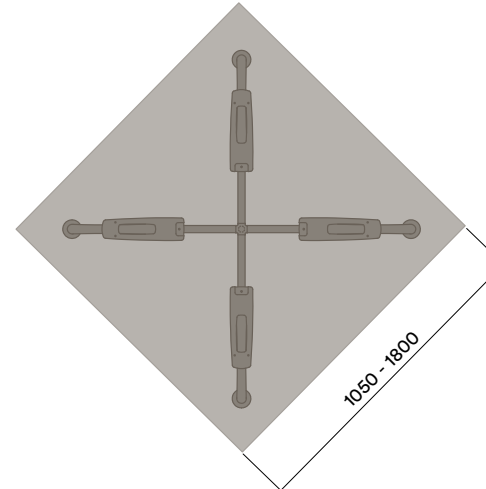
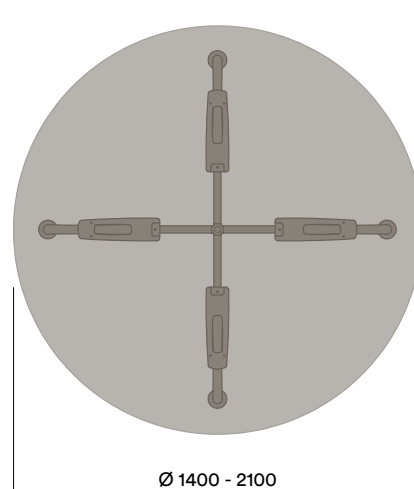

### Foot Finish

Aluminium Foot

- a. Polished - Standard
- b. Powdercoat - to match frame

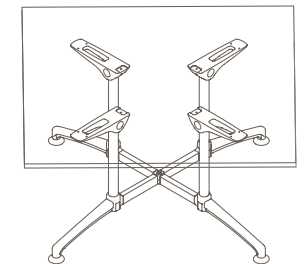
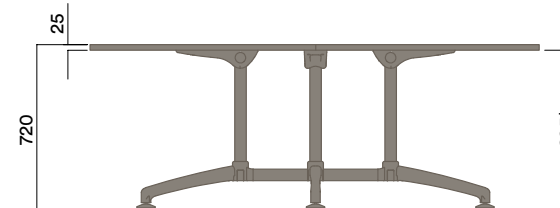
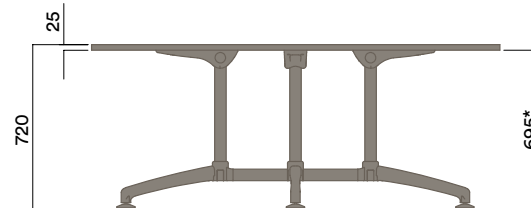

### Frame Finish

Polished Aluminium Top Horn

* Maximum Custom Height	1000mm
Maximum inc. worktop	80kg
Maximum Point Load	50kg
Seats	4-6

# Multi-Leg Rectangle

## Materials Information

### Leg Finish

Steel Leg Column

- a. Textured Black (standard)
- b. Chrome (standard)
- c. Blanc
- d. Noir
- e. Axel
- f. Folie
- g. Green Smoke
- h. Scotland Sky
- i. Minted
- j. Nocturnelle
- k. Pink Salt
- l. Zanilla

### Foot Finish

Aluminium Foot

- a. Polished (standard)
- b. Powdercoat (to match column)

### Frame Finish

Polished Aluminium Top Horn  
Steel Black Powdercoat Rails

## I-1050 4 Leg

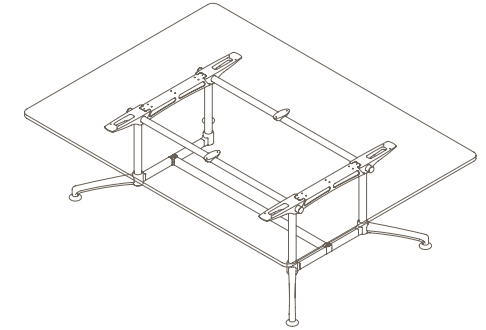
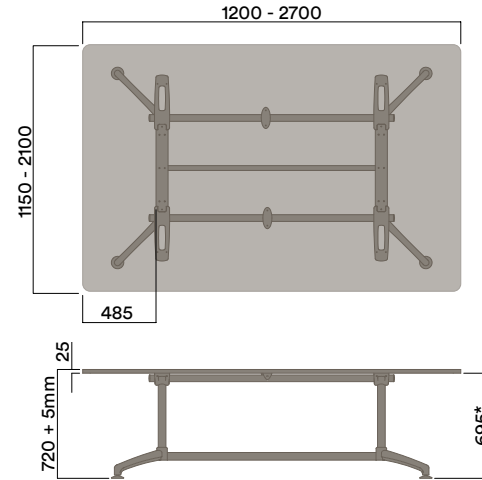

## I-1051 6 Leg

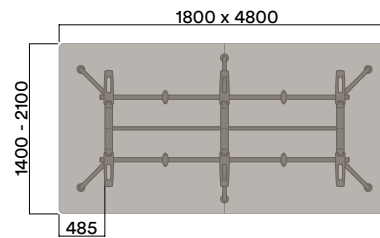

## I-1052 8 Leg

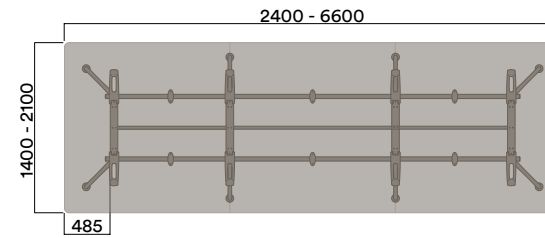

## I-1053 10 Leg

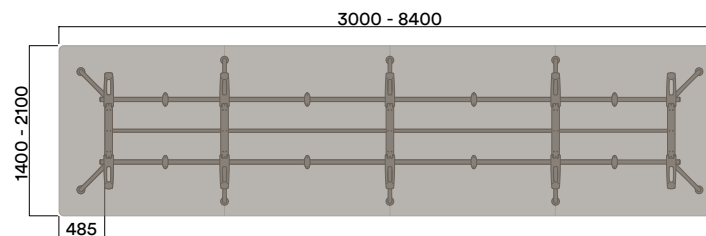

* Maximum Custom Height	1000mm
Maximum inc. worktop	160kg
Maximum Point Load	50kg
Seats	4-24

# Tables Folding

## Materials Information

### Leg Finish

Steel Leg Column

- a. Textured Black (standard)
- b. Chrome (standard)
- c. Blanc
- d. Noir
- e. Axel
- f. Folie
- g. Green Smoke
- h. Scotland Sky
- i. Minted
- j. Nocturnelle
- k. Pink Salt
- l. Zanilla

I-1080 , I-1082, I-1084, I-1086 720 (standard Height)

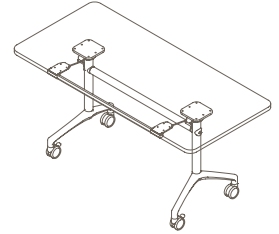
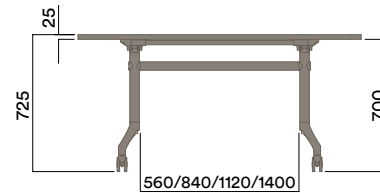
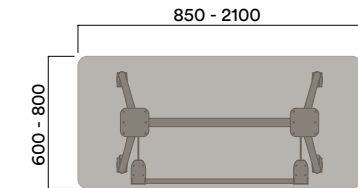

### Foot Finish

Aluminium Foot

- a. Polished (standard)
- b. Powdercoat (to match column)

I-1081, I-1083, I-1085, I-1087 720 (standard Height)

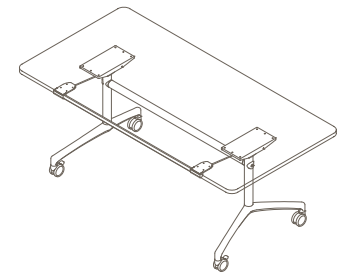
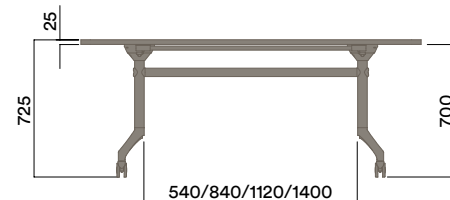
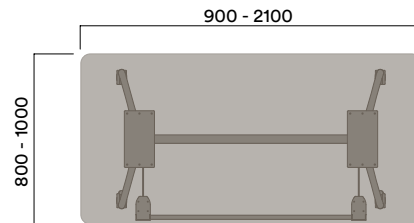

\* Maximum Custom Height 1000mm on Glides  
900mm on Castors  
Maximum inc. worktop 24kg  
Maximum Point Load 30kg  
Seats 4-6



# Tables Features

## Materials Information

### Frame Finish

Steel Slingshot

a. Powdercoat (to match frame)

Steel Power/Data Beam

a. Black Powdercoat

## Powerbox Management

## Slingshot

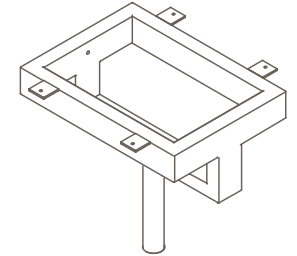
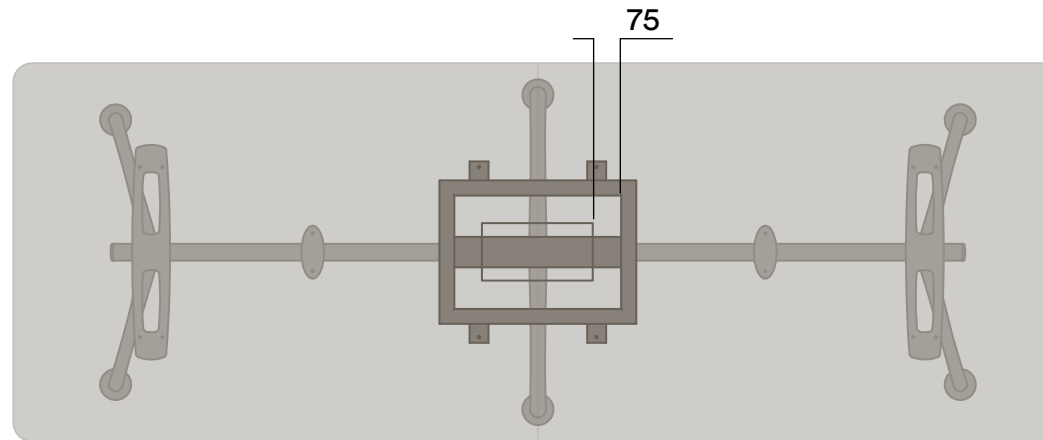

### Powerbox Slingshot

Suitable for I-1040 and I-1041 table frames

Replaces I.AM leg column to provide placement of powerboxes without frame interference

Made to order to cater for specified powerbox requirements and size

Provides 75mm clearance around powerbox to ensure fitment without frame interference

### Power/Data Beam

Suitable for I-1000, I-1001 and I-1002 frames

Suitable for I-1010, I-1011 and I-1012 frames

Replaces central rail to provide placement of powerboxes without frame interference

Made to order to cater for specified powerbox requirements and size

Provides 50mm clearance around powerbox to ensure fitment without frame interference

## Powerbox Management

## Power/Data Beam

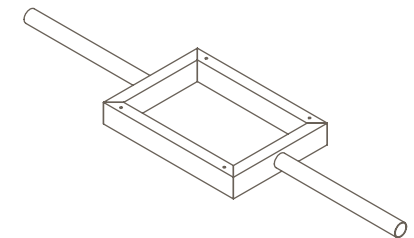
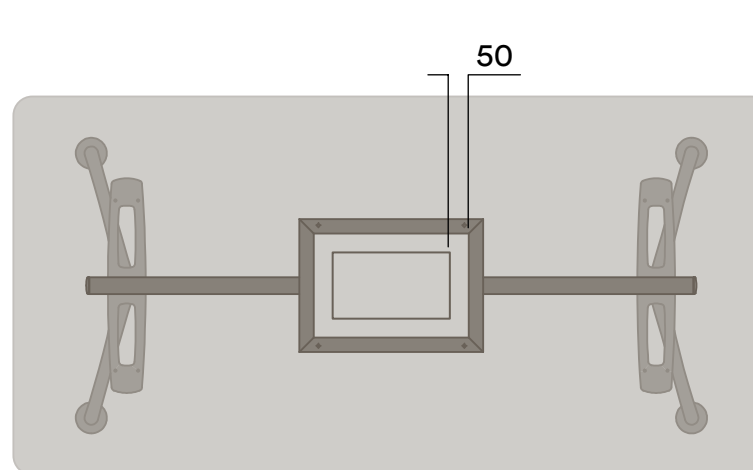

# Tables Features

## Materials Information

### Frame Finish

Steel Multi-Leg Spacer

a. Black Powdercoat

Steel Outrigger

a. Black Powdercoat

## Powerbox Management

## Multi-Leg Spacers

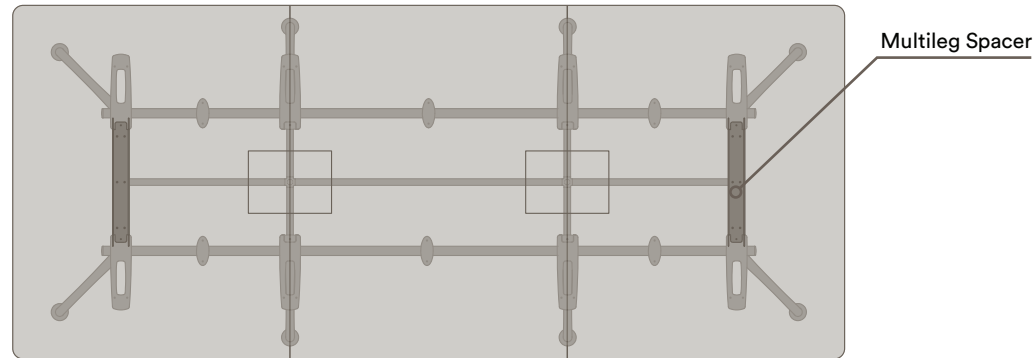

## Worktop Management

## Outriggers

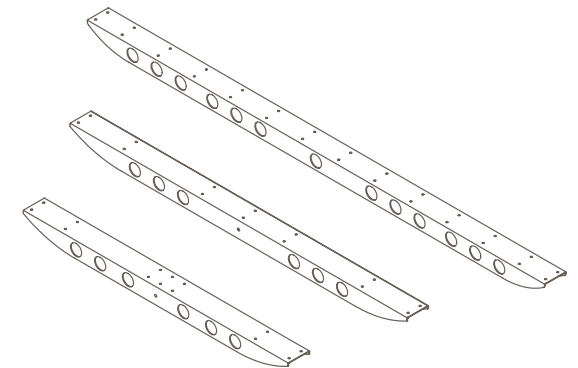
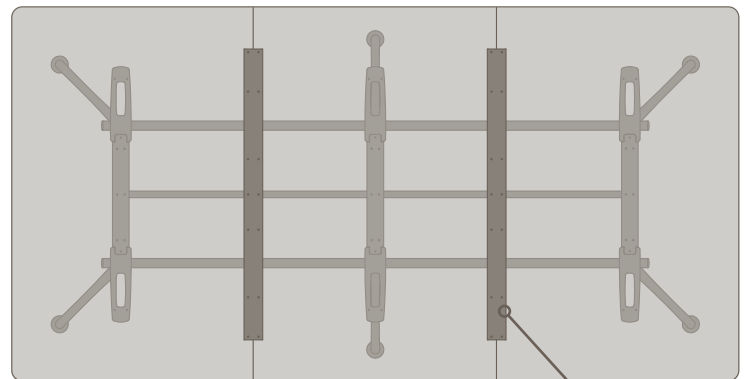

### Multi-leg Spacers

Provided with frame, spacers can be removed on-site to provide placement of powerboxes without frame interference

Applies to all Multi-Leg Rectangle Frames

### Outriggers

Additional Outriggers can be purchased to provide adequate worktop support on odd worktop splits

Outriggers available to suit SML, MED and LRG width Multi-Leg frames



## Specification

If you would like a sample set of any of our finishes, please call us on 61 (0)2 9726 7177 or e-mail at [sales@thinkingw.com](mailto:sales@thinkingw.com).

Due to our policy of continuous product development, specifications and finishes may change without prior notice.

## Sustainability Policy

We realise the importance of responsible business practices and have in place numerous product and company sustainability certifications. We would encourage you to download our annual Sustainability Report from the Thinking Works website to get a full overview of our sustainability program.

Thinking Works  
© Copyright 2020  
All right reserved

Thinking Works  
25 Helles Avenue  
Moorebank  
New South Wales 2170

[www.thinkingw.com](http://www.thinkingw.com)  
61 (0)2 9726 7177  
[sales@thinkingw.com](mailto:sales@thinkingw.com)