

LES



Levelling
Equipment
Services

Leica Geosystems Intelligent solutions for heavy construction



leica-geosystems.com



- when it has to be **right**

Leica
Geosystems

TABLE OF CONTENTS

Intelligent jobsite

ConX	4
PA10	6
iCON office	8
HxGN Smartnet	9

Off-machine

iCON site	12
Tablets	14
GNSS antennas	16
Total stations	20

On-machine

Panels	24
Excavate	28
Grade	40
Rig	58
Compaction	66
Pave	70

Services

Customer Care Package	82
-----------------------	----

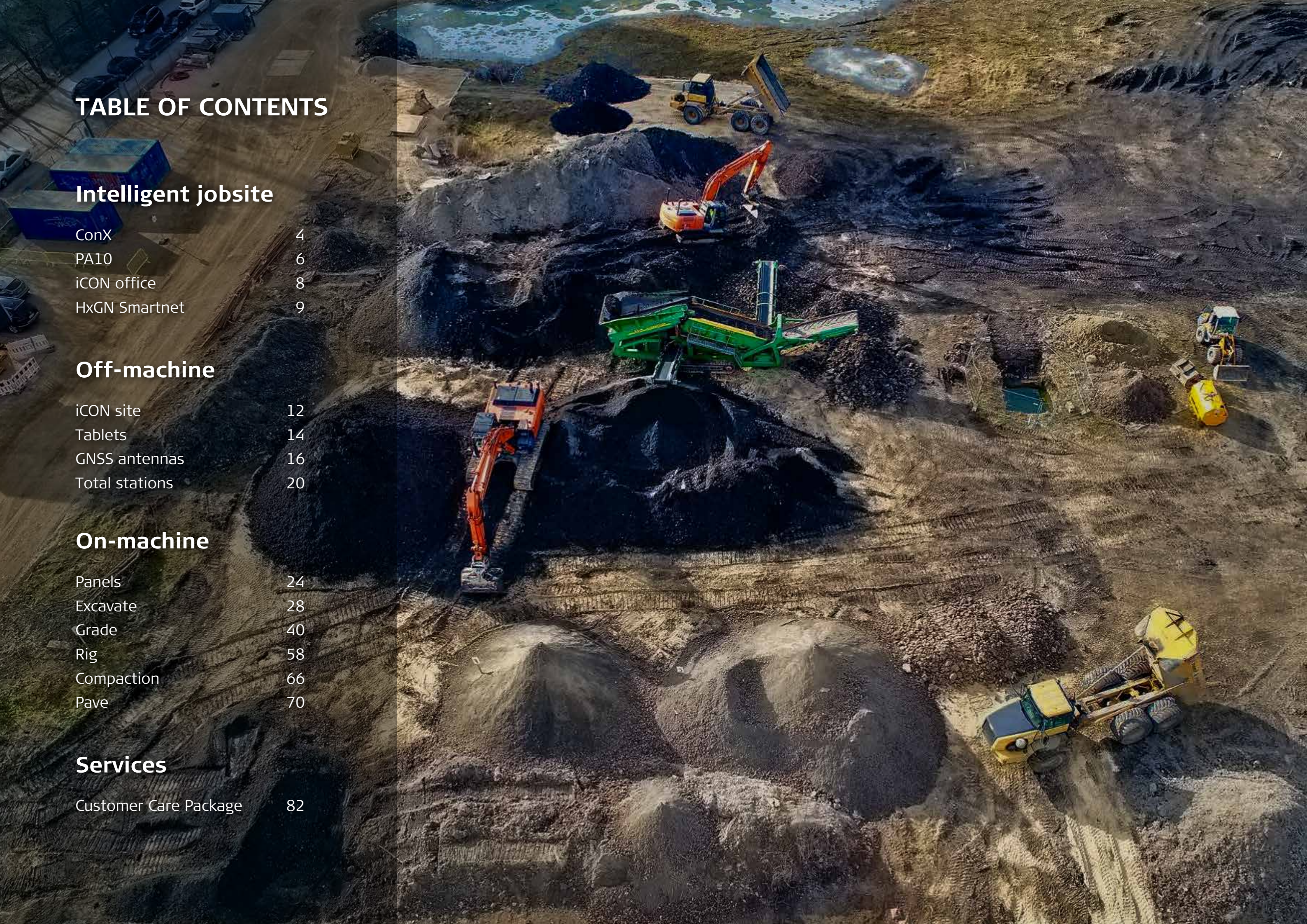

Leica ConX

Gain the ultimate transparency into your construction activity and monitor progress in real time from anywhere on any device.



Leica ConX

Easily visualise and share data through a powerful cloud solution and web interface

This cloud-based collaboration tool allows you to efficiently manage all your connected construction projects and to share job-related data with all stakeholders. Leica ConX enables you to visualise and validate localised reference models, survey data and constructed data with powerful analysis tools for monitoring and reporting site productivity.

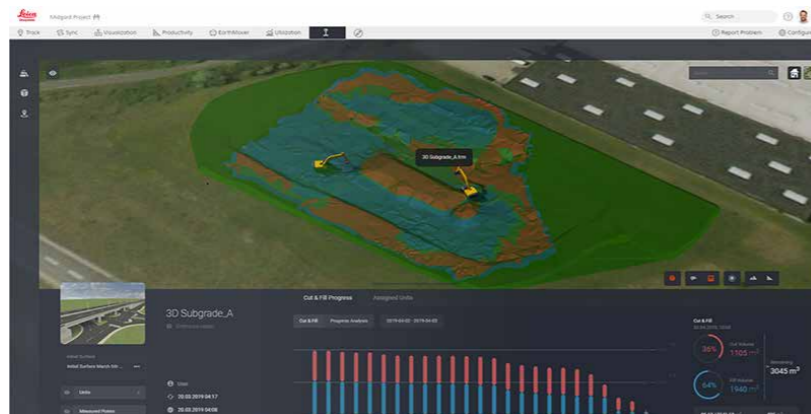

- Monitor the cut and fill situation in real-time
- Visualise designs localised on a 3D project map for quick and easy data validation
- Assign and automatically share designs and updates to 3D machines and surveyors
- Connect Leica desktop applications to ConX projects for direct field and office data sharing
- Minimise downtime with immediate remote support and trouble shooting
- Aggregate measured points from all connected sensors in real time
- Simple tools for analysing measured point data by source, time and design
- Powerful real time cut and fill analysis tool for monitoring project progress
- Current and historical volume calculating for automated project productivity analysis and reporting

Leica PA10 – Personal Aid

Leica PA10 is an innovative solution from Leica Geosystems that combines a tag worn by personnel moving around on foot one that communicates with machines on a heavy construction site. The goal is to create awareness for machine operators and pedestrians and create a safer working environment.



AWARENESS

PA10 is a proximity detection system to provide information about pedestrians around vehicles and machines on a heavy construction site. PA10 creates awareness for operators and pedestrians about their surroundings.

ALERT SIGNALS

Signal propagation time is measured between anchors installed inside machines/vehicles and battery-powered tags worn by pedestrians. The PA tag provides **audio**, **visual** and **haptic** feedback to the pedestrian, and the anchor provides **visual** and **audible** feedback to the machine operator or driver.

LONG-RANGE

PA10 is based on the latest Ultra Wideband (UWB) time-of-flight technology that provides ranges up to 40 m with +/-20 cm accuracy without separate RF link. It provides situational awareness and reliable alerts even under roof and closed spaces where GNSS coverage is limited or unavailable e.g. workshop, quarries.

Scalable

PA10 can be used for all machines and vehicles on a heavy construction site. The system provides three configurable alert distances around the machine or vehicle. PA10 is scalable from a single anchor up to 7 anchors on the vehicle.



iCON office – Speaks the language of your design data

The Leica Geosystems philosophy is to use the shortest possible path from design to field. By working in close co-operation with local and international design software suppliers Leica Geosystems has produced an application that can import and export data formats that have become de facto industry standards as well as many data formats that are used only in specific regions. These formats include, amongst others:

- AutoCAD DWG and DXF
- IFC
- Microstation DGN
- LandXML
- MX / Moss
- REB

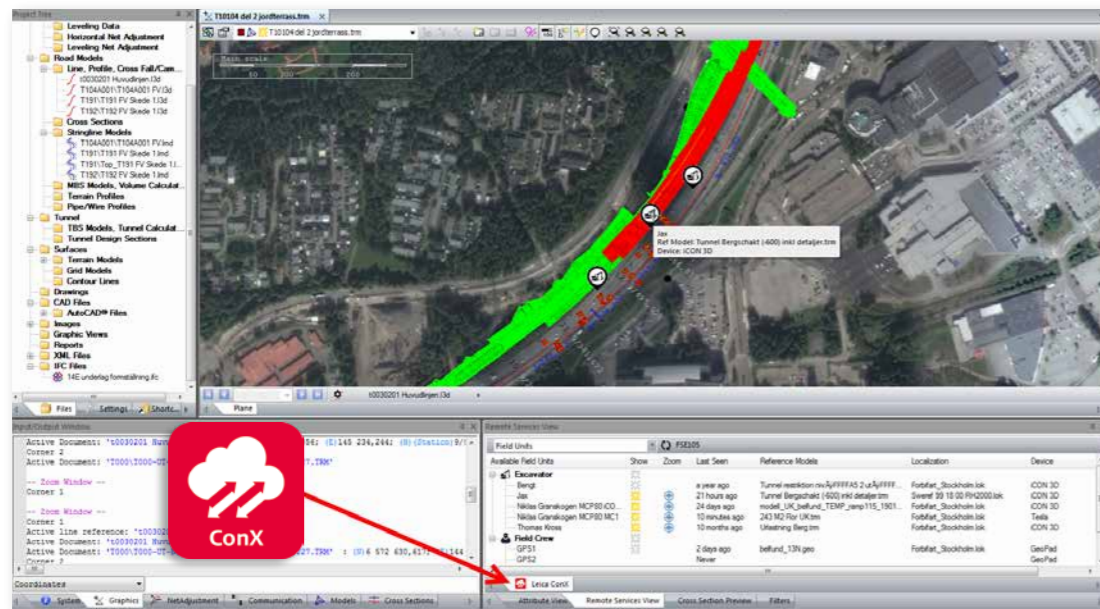

Direct connection to field units via Leica ConX

iCON office provides a seamless data flow from office to field through an API integration to Leica ConX. Available machines and their locations can be displayed in iCON office. The integration also allows sharing of design and as-built data directly between iCON office and equipment on site.

Work with a range of different design models

Different design entities from simple road alignments to more complex road stringline, cross-section or layer models as well as digital terrain models and background maps may be used with Leica iCON office.

Send your design data to all of your machines and sensors from one package

Leica iCON office is compatible with many different machine control systems. The software supports a range of machine control systems and measurement sensors from Leica Geosystems as well as other manufacturers.

Calculate as-built cost estimates using volume analysis

The optional Leica iCON office terrain model module allows accurate surface to surface or surface to elevation volumes for cost estimation purposes. This module allows complete control of the surface models used for calculation including boundaries and breaklines. The module may also be used for creating terrain profiles and sections.

Easy and quick quality control reporting

Leica iCON office offers various standard reports for quality control reporting. For example, a statistical check and tolerance report of deviations with respect to a design surface can be created at the click of a button.

Save time and costs

The Leica iCON office package has an easy to use interface that allows you to be up and running in a short period of time. Use the self-training package delivered with the software or take advantage of one year's free technical support that is included with the licence. In addition to the simple user interface, Leica iCON office works the way you are used to, using the built-in AutoCAD® engine to open and edit native AutoCAD® drawings.

HxGN Smartnet – GNSS data over the world's largest reference station network

HxGN SmartNet is an integrated 24/7 GNSS network RTK and GNSS correction service, built on the world's largest reference network, enabling GNSS-capable devices to quickly determine precise positions.

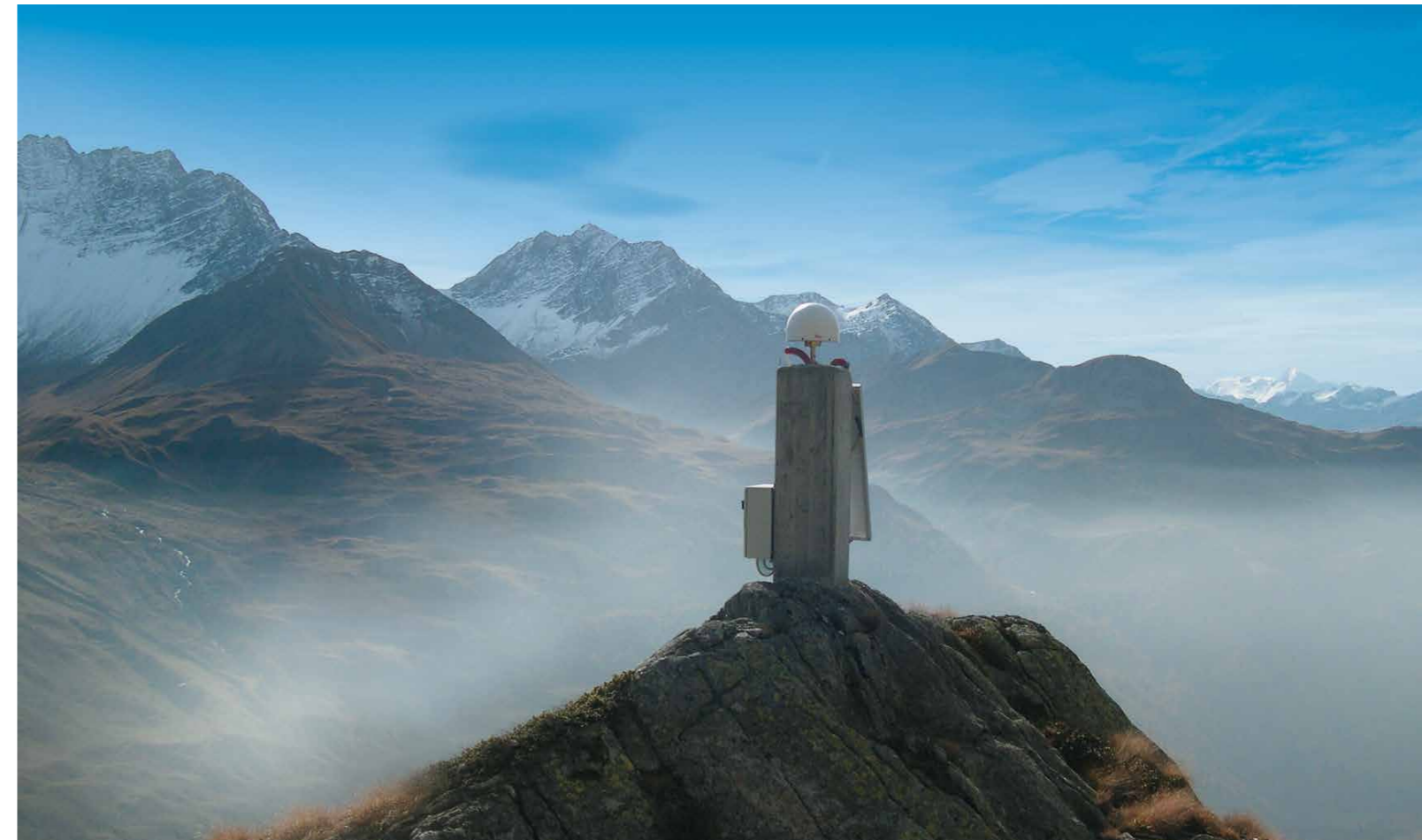

The service is provided continuously by a highly available infrastructure and professional support team with more than 10 years of experience reliably delivering the service. HxGN SmartNet is an open standard correction service, able to use with any GNSS device, and is constantly monitored for integrity, availability and accuracy. With more than 4,500 reference stations based on Leica Geosystems technology that ensure position accuracy in any application, HxGN SmartNet is easy-to-use and provides the fastest precise positions.

HxGN SmartNet was built to provide high-precision, high-availability network RTK corrections for any application, using any constellation, while at the same time being open to all. With easy access to precise correction data, Network RTK users experience the best availability, reliability and traceability using internationally recognised standards, together with flexible and affordable subscription options that meet the needs of the local market. With a robust, traceable and repeatable network RTK correction, users can expect centimetre-level accuracies. Quality of service is guaranteed through our highly sophisticated data centre and monitoring systems.

Off-machine solutions

Invest in the solution you need today and have the flexibility to expand your product portfolio based on your future needs tomorrow.

Maximise your investment with flexible hardware and software solutions that allow you to carry out critical positioning tasks with confidence. These on-the-ground solutions not only increase your efficiency, but your peace of mind as well.



iCON field software



Tablets



Smart-Antennas



Robotic total stations

Leica iCON site – Profit from your investment



User interface customised for construction personnel

iCON site is designed to increase your productivity and enable you to adapt to any given scenario on site. If you work with machines on site, use iCON site to check your progress to determine if you are working to the correct depth, profile, grade or surface, without having to wait for an engineer or surveyor to carry out these tasks. iCON site is developed to seamlessly integrate with any of the Leica iCON sensors and machine solutions.

Using the same, interchangeable user interface means:

- You only need to learn its functionality once resulting in less training, increased motivation and significantly reducing your investment
- The ability to exchange hardware and data between on-machine and off-machine use, projects and site personnel maximises your flexibility and reduces possible downtime

Exceptional application functionality

The features and graphical support within iCON site allow you to carry out specific tasks on site in an easier, straightforward way. Use iCON site for checking dimensions, volumes, positions and the status of key site elements. iCON site allows the user to complete all site related tasks from one measuring device ensuring an effortless process from start to finish.

- Simply measure, stake-out or check site elements without waiting for an engineer or surveyor to do the work for you
- Benefit from quick volumes and checks by using iCON site for site navigation on your vehicle
- If using 2D machine control, iCON site allows the operator to mark out the required starting point or boundary of the profile to be used on the excavator or dozer

Leica iCON site for foremen – Take the guesswork out of your project

With the Leica iCON site field solution you can increase efficiency and quality of work on site. The Leica iCON field Supervisor and Foreman kit from Leica Geosystems gives you instant real time access to project statistics in the field, allowing you to make informed decisions quicker than ever before. Instantly increase site productivity by checking the efficiency of your machines and site personnel with an easy-to-use in-cab display, make checks on whether your project is on time, on budget and on specification. With iCON site software you can carry out accurate as-built checks, grade checking and volume calculation.



Leica iCON CC70/CC80 – Real-time communication on site

Leica iCON CC70/CC80 versatile tablet PC's are designed to transport a user's office directly to the field. The rugged, lightweight devices have a clear and easy-to-use 7" touchscreen designed to facilitate with data collection tasks on site, while at the same time communicating with the central office, real-time data transfer is made easy.



Leica iCON CC70

High-end controller designed for standard construction measure and stakeout tasks

Leica iCON CC80

Rugged premium controller with maximum performance to boost all site tasks to improve productivity without compromises

LEICA iCON CC70/CC80

- Leica iCON CC70/80 controller series are the world's thinnest and lightest fully-rugged 7" Windows® tablets and feature a battery life of up to 16 hours
- Large 7" sunlight readable touchscreen display for convenient operation
- Windows 10 multi-lingual, multi-touch operating system
- Various wireless communication possibilities (Bluetooth®, Wi-Fi and integrated 4G/LTS multi-carrier mobile broadband) for use with different sensors and internet access
- The CCD17 Bluetooth® radio kit extends the robotic working distance between the CC70/CC80 tablet computers and Leica iCON or Nova total stations

Leica iCON gps 60 – Smart positioning on any construction site

Leica iCON gps 60 is a versatile SmartAntenna for all construction positioning tasks. Featuring superior GNSS technology and various integrated communication options, it meets all your requirements for reliable and accurate measurements. Its intuitive display shows full status information of the instrument, simplifying operation and configuration. Leica iCON gps 60 also offers exceptional network capabilities allowing you to use RTK network services (Leica SmartNet and other networks) for highly reliable, improved GPS positions.



LEICA ICON GPS 60 SMART ANTENNA

- Superior GNSS technology for maximum accuracy and reliability
- Features Leica SmartTrack+ and SmartCheck+ and Leica xRTK
- Future-proof satellite tracking. Works with all existing and future satellite systems.
- SmartLink – bridges RTK communication gaps up to 10 minutes
- Multi-purpose GPS solution. Can be used as construction site GNSS Base, Rover or NetRover, in supervisor vehicle on site and entry level machine control mounted inside a machine, increasing machine productivity
- Unique communication flexibility, featuring integrated radio, modem and Bluetooth®
- System integration made easy through use of platform independent SDK (Software Development Kit) bringing swift configuration to all
- Integrated NTRIP Server and Caster for Internet based Reference Station
- No controller required for base station set-up means you need less hardware.
- Unique flexible software licencing and feature upgrade concept
- You can order packages or individual licences when you need them, investing when you need to

All-purpose GNSS solution

iCON gps 60 is the perfect mobile base station for your construction site. You don't need a controller for base station setup. Stream corrections over the internet without radio and easily and quickly perform many positioning tasks yourself. Check grade or cut & fill, stakeout points and lines, and as built checks. Save time and increase productivity monitoring the grade from your supervisor vehicle on site.



Leica iCON gps 70 Series – Most efficient construction GNSS smart antennas

The Leica iCON gps 70 and Leica iCON gps 70 T represent Leica Geosystems' ultimate GNSS rovers and field solutions for maximum efficiency. With the iCON gps 70 T you can measure and stakeout points quicker than ever before without the need to keep the pole vertical and level the bubble. The combination of the latest GNSS technology and inertial measurement unit (IMU) equips the iCON gps 70 T with permanent tilt compensation and makes it resistant to any magnetic interference. Being fully calibration-free, the iCON gps 70 T is ready when you are – anytime, anywhere.

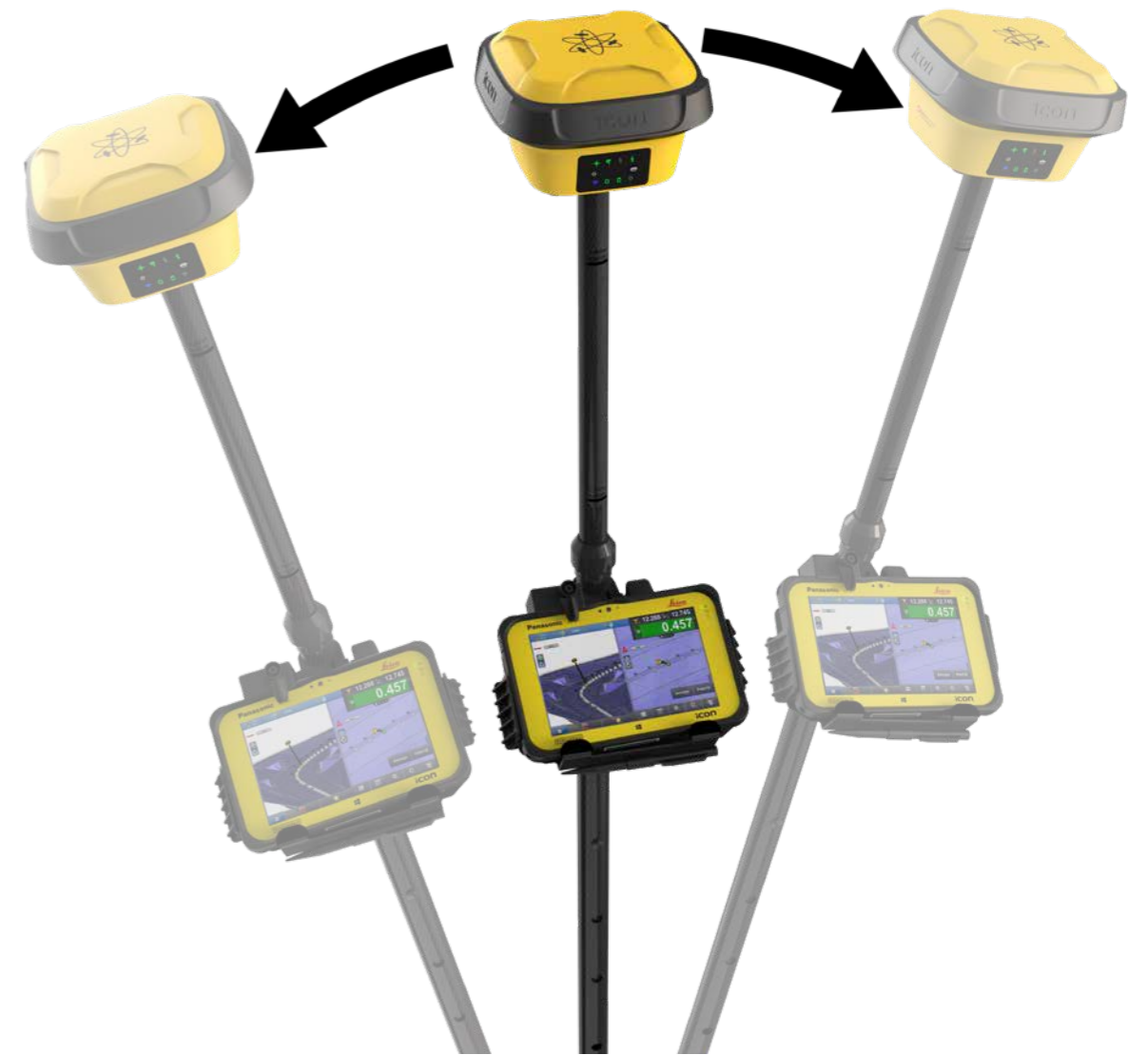

PERMANENT TILT COMPENSATION

- Calibration-free
- Resistant to magnetic interferences
- Increased measurement productivity and reduction of human error

FUTURE-PROOF GNSS TECHNOLOGY

- 555 channels for more signals, faster acquisition and improved sensitivity
- Intelligent management of multi-frequency, multi-constellation signals
- Intelligent selection to automatically reject reflected or noisy signals

HARDWARE & ERGONOMICS

- Compact and lightweight housing
- UHF radio
- Tilt and non-tilt variant

ROBUSTNESS FOR DEMANDING SITES

- Leica iCON CC70/80 controller series are the world's thinnest and lightest fully-rugged 7" Windows® tablets and features a battery life of up to 16 hours
- IP66 / IP68 protection
- Built for extreme temperatures of -40°C to +65°C
- Fulfils toughest standards throughout the complete product lifetime
- Rugged aluminium housing

SMARTCHECK+ & SMARTTRACK+

- Unique RTK technology provides continuous checks to guarantee correct results
- Initialisation within seconds
- Complete reliability

ICON FIELD SOLUTION

- Seamless integration into the iCON field solution
- Easy-to-use software interface and seamless data flow throughout the workflow
- Exceptional application functionality
- Leica ConX cloud-based collaboration tool for real-time 3D data exchange

Leica iCON iCR80 – High performance total station for one-person operation

Save time and increase your productivity by doing layout work and as-built checks yourself. With the iCON iCR80 you don't need an operator at the instrument. The robotic total station can be operated from the machine or the field controller at the prism pole, at the point you need positioning.



LEICA ICON iCR80 FEATURES

- Faster prism search by patented technology, PowerSearch
- Stable data communication with long-range Bluetooth® (up to 400 m)
- Easy hand-over control from pole to machine and vice versa
- ATRplus technology, maximising the total station's ability to remain locked onto your machine mounted prism
- "Tune out targets" feature to ignore other distractions in the field
- Fastest re-lock in case of interrupted line of sight

BENEFITS

- Obtain the highest accuracy for machine control of a wide variety of construction machines, such as curb and gutter or milling machines, asphalt or concrete pavers, and graders and dozers
- Use iCR80 for machine control of construction machines when working inside tunnels or where GNSS coverage is weak or not available
- Work with multiple iCR80 total stations for automatic leap frogging of paving machine for continuous paving and increased surface quality
- Use iCR80 for as-built documentation

Leica iCON iCR80

The Leica iCON iCR80 construction total station keeps its 'eye' on only one thing: the user's target. Move or place more material per day thanks to ATRplus, the most robust automated-aiming, lock and re-lock technology in the market. iCR80 is especially useful in congested sites with many distractions, such as reflections, machines and people moving around. Challenging and changing site conditions should not be an obstacle.

The iCON iCR80 guarantees efficiency with the most reliable, simple and automatic set up procedure and industry-leading prism lock. This sophisticated, one-person total station offers an 'all-in-one' solution for every purpose – especially the difficult ones, allowing you to speed up your workflow.

On-machine solutions

Increase accuracy, productivity, and uptime with Leica Geosystems' machine control solutions. With a powerful feature set and real-time designs sent straight to the machine, avoid rework, material waste, and reduce crews needed on site – meaning a safer work zone.



Excavator solution



Dozer solution



Grader solution



Wheel loader solution



Driller solution



Piler solution



Compaction solution



Asphalt paver solution



Milling solution



Concrete paver solution

Leica MCP80 and MC1 – One panel, one software, **always connected**

The new Leica MCP80 can handle all 3D applications in heavy construction. You can easily move your panel from machine to machine no matter the application. The new Leica MDS series in-cabin docking stations will store your calibration values and hydraulic parameters for worry-free machine swapping. These docking stations require no long-winded setups when switching panels. And at an IP67 rating, these are truly the most resilient docking stations for the heavy construction industry.

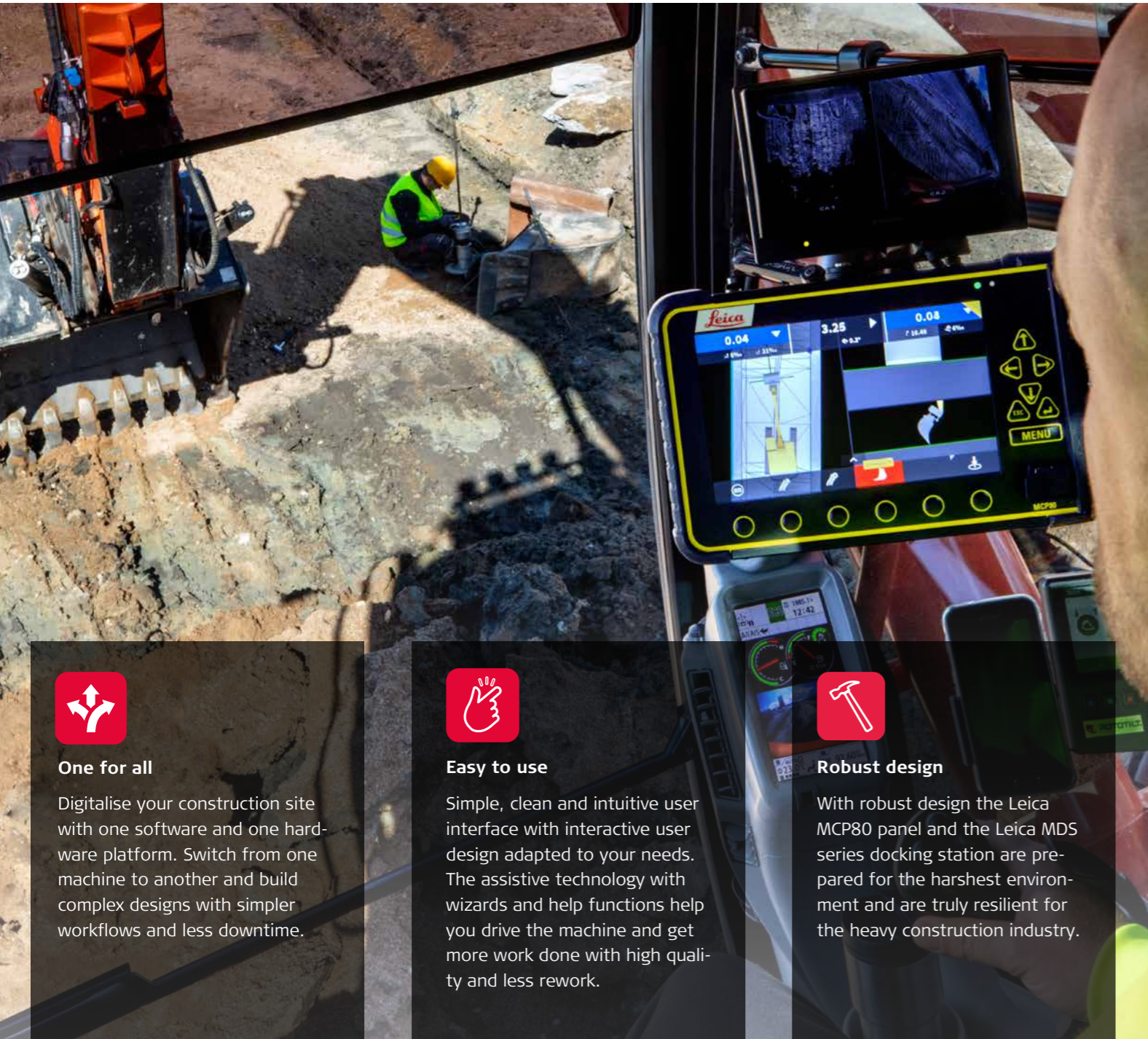

One for all

Digitalise your construction site with one software and one hardware platform. Switch from one machine to another and build complex designs with simpler workflows and less downtime.



Easy to use

Simple, clean and intuitive user interface with interactive user design adapted to your needs. The assistive technology with wizards and help functions help you drive the machine and get more work done with high quality and less rework.



Robust design

With robust design the Leica MCP80 panel and the Leica MDS series docking station are prepared for the harshest environment and are truly resilient for the heavy construction industry.

Leica MCP80 – One panel, **complete control**



MCP80 is available for:



Excavator



Dozer



Grader



Wheel loader



Driller



Piler



Compaction



Asphalt paver



Miller



Concrete paver

One common platform

Optimising the machine fleet

Leica Geosystems delivers an intelligent and intuitive hardware and software combination for the heavy construction industry – the new all-in-one machine control platform consisting of a panel, MCP80, and docking station combined with a new application software, MC1, supports multiple machines for heavy construction.

Simplified and connected solutions for increasing staff productivity on site and unifying design data for seamless workflows are essential to keep margin gains and generate profits. With the all-in-one machine control platform, Leica Geosystems delivers a unique, intelligent and intuitive hardware and software combination for the heavy construction industry.

Leica Geosystems' solution for heavy construction applications offers a unified hardware platform with common software interface across our machine control portfolio. Interchangeable between several heavy construction machines, the Leica MCP80 control unit integrates into the common software platform, Leica MC1, while Leica ConX, the cloud-based and user-friendly productivity platform for increased project efficiency, rounds off Leica Geosystems' goal to achieve a digitised construction site.

MCP80 & MC1 FEATURES

- Fully cable free
- Easy removal of panel
- P67 environmental rating
- One common interface across all 3D machine control applications
- Simple and intuitive user interface
- Easy installation and quick setup for operators
- Rugged design of cradle and panel
- Docking station with onboard memory
- One software for all for easier operation

2D panel – One panel, multiple machines

The Leica Machine Control solution allows you to easily interchange, customise, and upgrade system components in order to provide you with the most flexible and cost-efficient solution on the market today.



PowerSnap™ Technology

Use your panel on several machines in your fleet without the hassle of installation. This cable-free configuration allows for simple and fast exchange of panels between different 2D machines. The cradle is installed once and stores machine specific settings.



BENEFITS OF 2D

- Rapid interchange of control panels between machines
- One cradle for all iCON 2D excavate and iCON 2D grade panels
- Easy removal of core components for overnight security
- Contact and cable-free connection to control/display panels
- Unique patented Snap-On & Snap-Off capability

2D panel is available for:



Excavator



Dozer



Grader



Excavator solution

From simple slope grading, to blind and submerged cuts, and everything in between, our versatile machine control solutions provide your excavator operators with design models right in the cab. The easy-to-operate user interface means your operators can jump on it with little training and get optimal results. Grade check without a surveyor with our robotic total station guidance or our GNSS setup for advanced control. And at the end of the day, the core components snap off for maximum security.



Leica iCON iXE1

Even for the not so complex excavating tasks, the 1D guidance solution provides far superior laser guidance over traditional practices.

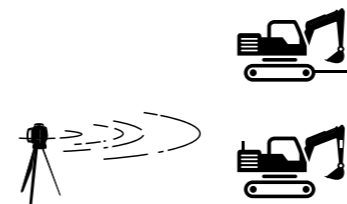

Leica iCON iXE2

Our 2D solution gives the operator high-accuracy dual slope and level control for maximum utilisation of your machine from the start.

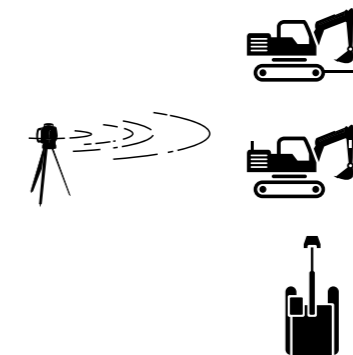

Leica iCON iXE3

For those who need the ultimate precision guidance, the 3D machine control solution is available. Work from 2D and/or 3D digital models for supreme accuracy and the most complex designs.

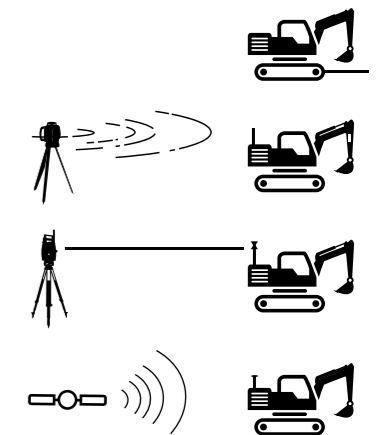

Leica iCON iXE3 – The future of excavating

The iXE machine control solution guides the operator using reference models and GNSS in 3D. Design information and real-time cut/fill indications are displayed in the cab on your control panel, allowing you to rapidly excavate to the reference design. The solution ensures more uptime and operator satisfaction while increasing safety and productivity.

Work with a wide range of popular data formats including LandXML, DXF, GEO, KOF, L3D, LMD, LIN, MBS and TRM formats. The operator can use the function **Create Model** to make even complex models directly on the panel without leaving the cab and without the assistance of a surveying engineer.



Excavator 3D solution – Full 3D and 2D control of your excavator

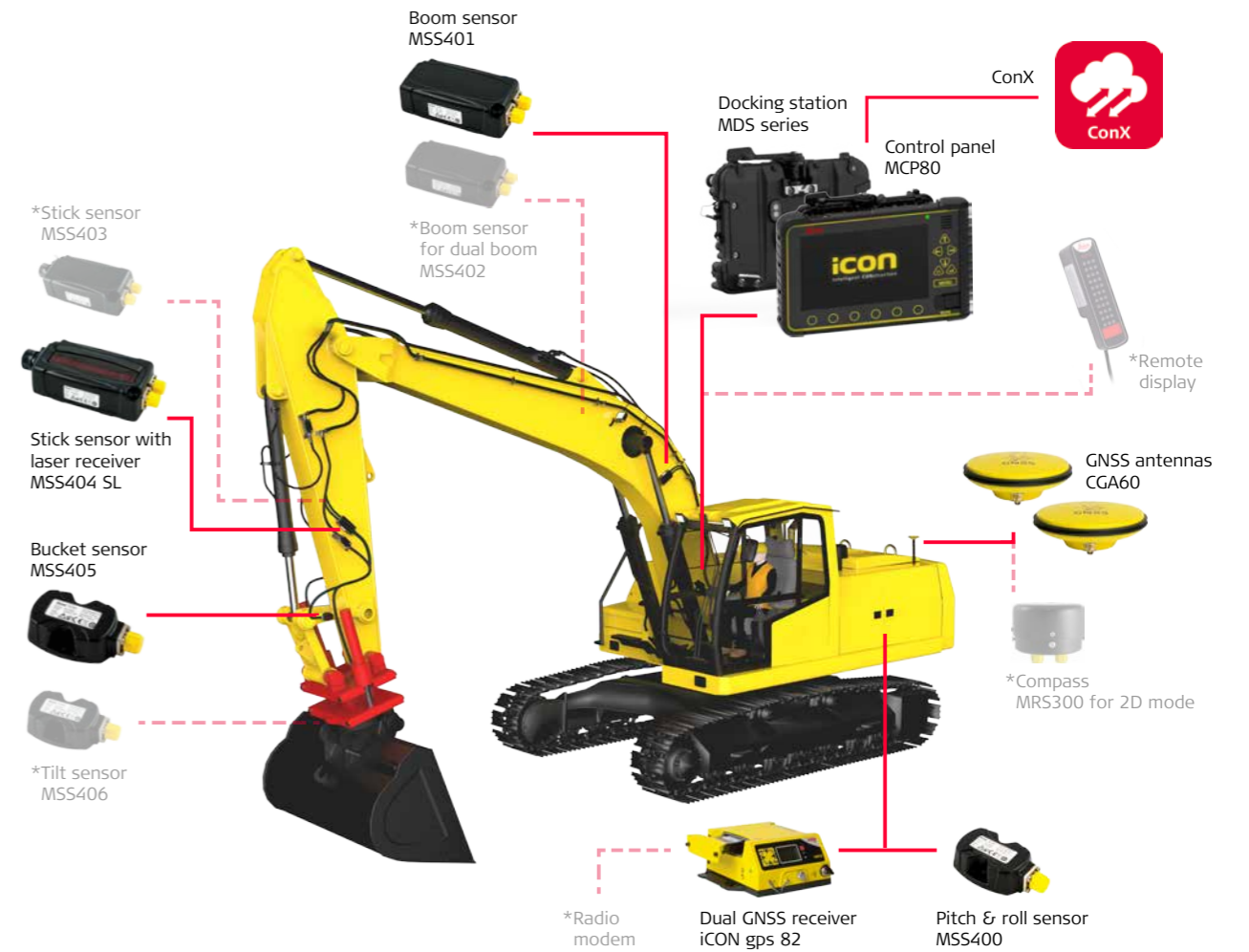

Other available options:



Prism & compass configuration

Simple user interface

Assisting the excavator operator's workflow

The iXE3 machine control solution guides the operator using reference models and GNSS in 3D. The user interface, with excavator relevant functions and wizards keep the operator in the run screen and assists him through the workflows to keep a targeted attention to the job at hand.



Leica iCON iXE2 – Single/dual slope and depth control

This multifunctional 2D control system is designed to make excavating easier and more productive. It allows multiple elevations and slopes to be constructed, at any orientation, without resetting the machine or laser height reference.



Excavator 2D solution

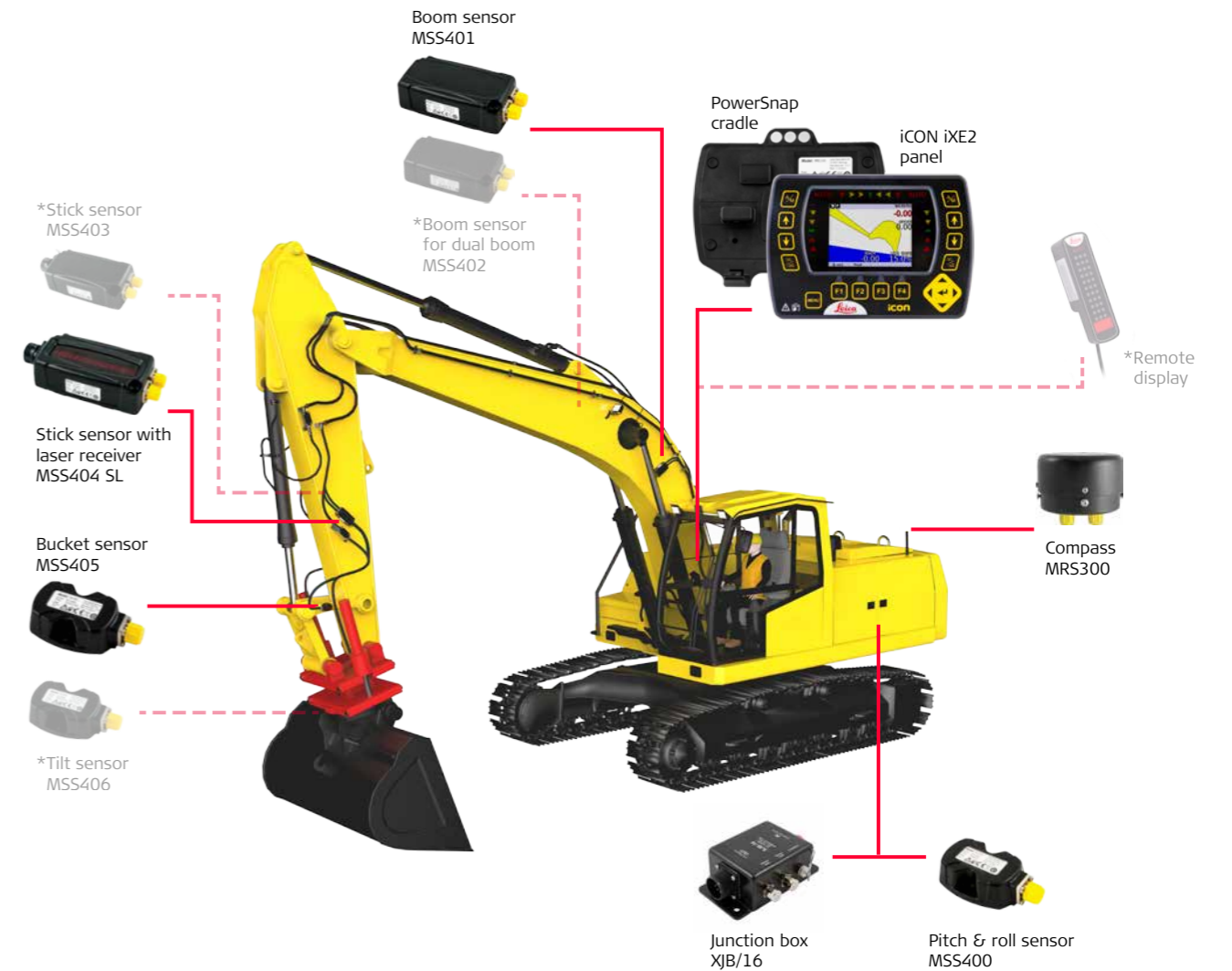

Leica iCON iXE2

The Leica iCON excavate iXE2 displays the bucket's actual position relative to design elevation and slope, allowing you to reach the design grade faster. This multi-functional 2D machine control solution is designed to make excavating easier and more productive. It allows multiple elevations and slopes to be constructed, at any orientation, without resetting the machine or laser height reference.

BENEFITS OF ICON iXE2

- Upgrade to 3D by adding a GNSS receiver and 3D control panel.
- High-accuracy dual slope and level control via the rotation sensor
- Real-time cut/fill indication on the graphic display
- No grade checking needed
- No more over excavations

Leica iCON iXE1 – Simple single slope control solution

This is the ideal solution for contractors who want to start with machine control. Its easy-to-use single slope control panel is designed specifically for standard excavating applications.



KEY BENEFITS OF ICON iXE1

- Easy single slope and depth
- Increase machine productivity
- Graphical cut/fill indication in the cab
- No more over excavations
- Get done in fewer passes
- No batteries to charge

Excavator 1D solution

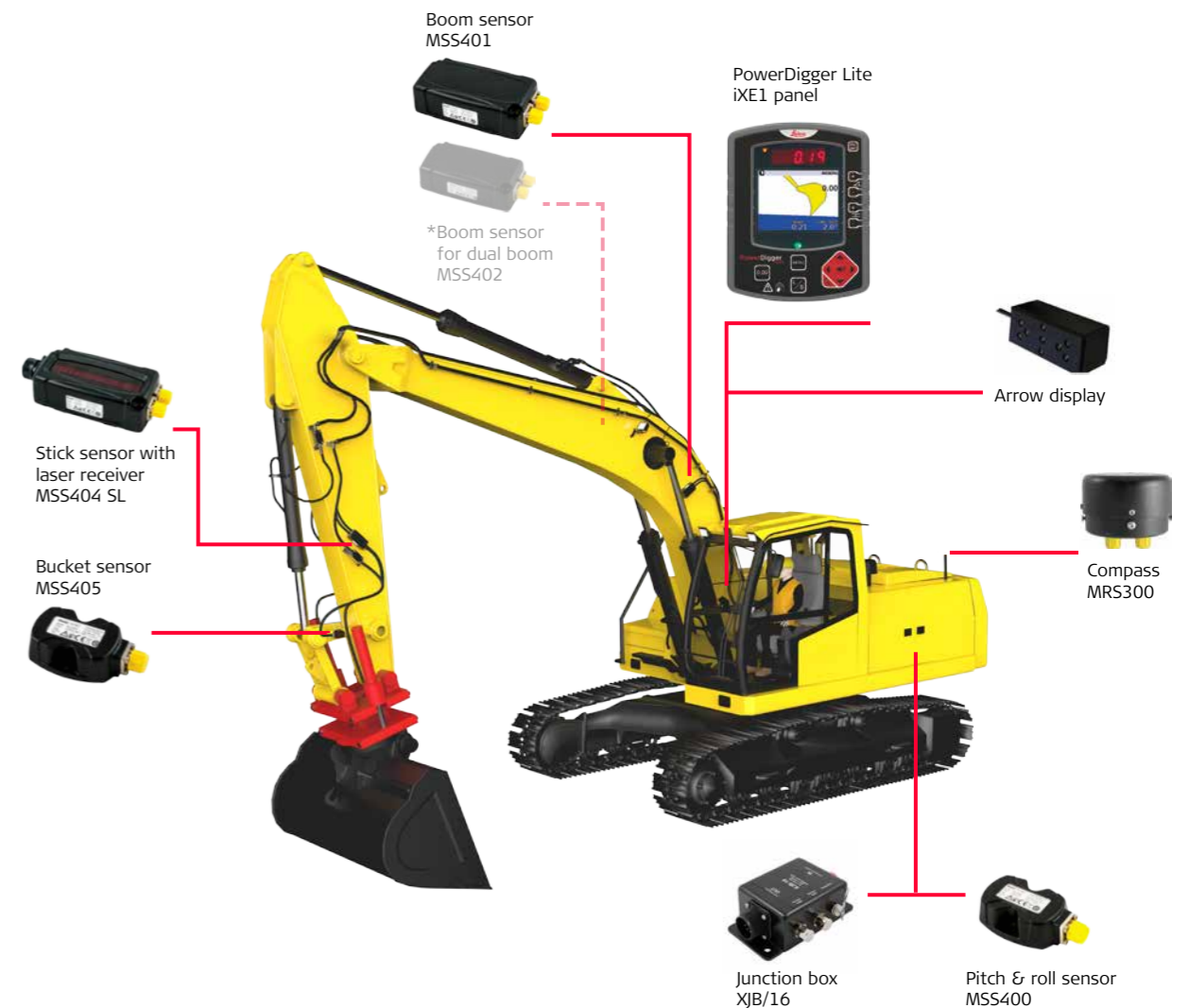

Leica iCON iXE1

The Leica iXE1 is a simple, economic excavator control system that's perfect for backhoes and mini excavators. This single slope control panel can even tackle difficult tasks like blind cuts or digging underwater. The iXE1 has the flexibility to work from different references such as existing surface, string line, or a laser reference.

SYSTEM FEATURES

- 3.5" colour graphic display
- Simple menu structure - very easy-to-use
- Remote display supported
- 100 % waterproof (IP68) – no special sensors or cables needed for underwater use
- Offset your reference surface
- Visual and audio guidance according to reference height

iXE CoPilot – Automatic tilt rotator control

Using the Leica iXE CoPilot, the excavator operator only needs to concentrate on controlling the digging movement (boom, stick and bucket) while the tilt and rotation function of the tilt rotator is adjusted automatically based on the reference model surface under the bucket.

The operator maintains control of the bucket rotation allowing him to manage material in the bucket properly but eliminating the constant manual adjustment of the slope of the bucket. Enabling the CoPilot by simply pressing a button simplifies the use of tilt rotators regardless of training level reducing operator fatigue.



Leica TRM – Automatic Tool Recognition

Use tool recognition to automatically select the right tool for your excavator or wheel loader. Tool recognition modules are mounted on the excavator buckets and tilt rotators. The hub in the cabin registers and sends signals to the machine control solution when the bucket is taken off, a new bucket is selected and sends warnings if a bucket that is not calibrated is selected.

The operator no longer needs to manually change settings when changing work tools. This minimises the risk of using the wrong bucket and the subsequent over or under digging and costly rework. Besides supporting the attached tools, the tool recognition system also supports standard tilt buckets and detachable tilt rotators.





Submersible configuration – Underwater excavating

As part of the MSS400 series, the MSS420 sensors for underwater dredging jobs are built on the well-established MSS400 Series Sensor technology. Ensuring speed, performance, precision and productivity (SP), the MSS400 Series Sensors incorporate SP Technology that allows faster digging without loss of precision at higher speeds, dramatically increasing machine utilisation and productivity.



Reinforced cabling, sensor housing and bracket

Designed to be used down to 40 m at 5 bar pressure, the MSS420 sensors are equipped with reinforced components such as pressure tight connectors, a robust sensor housing, rugged cabling and stainless-steel brackets making it the most reliable equipment for underwater applications. The Leica MSS420 dredging sensors can be programmed to boom 1, boom 2, stick, bucket and even tilt sensors.





Dozer solution

With our machine control solution for dozers, you can tackle any task from small road excavation jobs, to large industrial sites. Our solutions give the operator proficiency with little training and an easy-to-use yet powerful interface. Pair our flexible solutions with a rotating laser, total station, or GNSS to tailor to your needs, and optimise your productivity and workflow on site. Core components can easily be dismantled.



Leica iCON iGD2

Our entry level machine control solution for dozers gives you powerful control over your machine. Work with a variety of different sensors and make tasks easier.

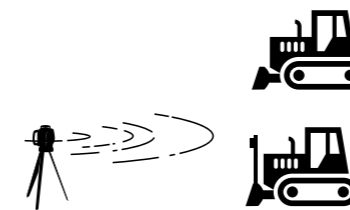

Leica iCON iGD3 & iGD4^{SP}

Our 3D machine control solutions for dozers give you accurate and independent control of your dozer, anywhere on the project design.

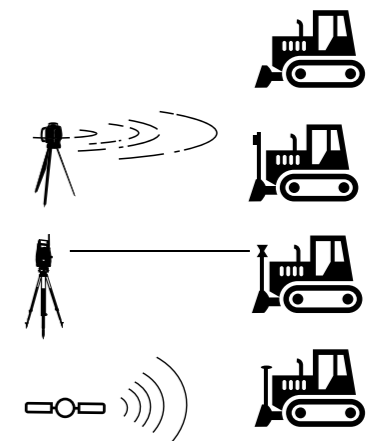

Leica iCON iGD3/ iGD4^{SP} – Intelligent 3D grading solution for dozers

The iGD3 3D dozer solution opens new dimensions in earthmoving and fine grading. It brings the design surfaces and alignments inside the cab. Work independently and accurately anywhere on the project design, guided by GNSS or total station.



BENEFITS OF IGD3/IGD4^{SP}

- User-selectable views (e.g. Plan View, Cut & Fill View)
- Visible display screen, even in sunlight.
- iGD3 remembers all your settings
- Scalable from 2D to full 3D capability
- Create a reference surface with up to four slopes

Dozer 3D solution

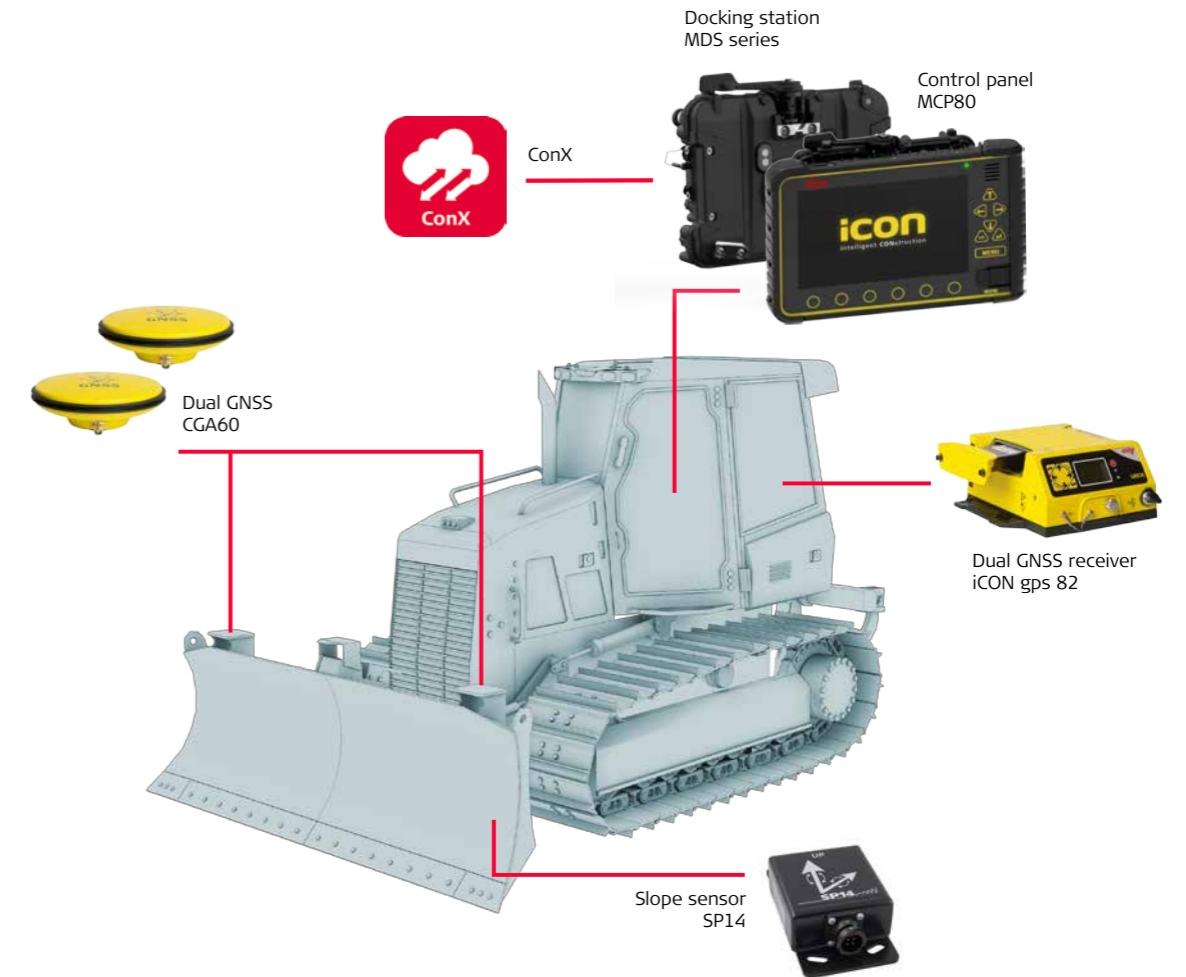

Leica iCON iGD3

The Leica iCON grade iGD3 solution can dramatically increase machine utilisation and productivity and optimise material usage on any earthmoving and fine-grading contract. It can be used with a wide range of sensors and combines ease-of-use with unrivalled flexibility and a powerful and intuitive user interface.

Leica iCON iGD4^{SP}

iGD4^{SP} is ideal for dozers with six-way (PAT) blades. Having a second GNSS antenna on the blade will improve the accuracies your dozer can achieve when working in very demanding environments such as steep slopes with the blade fully angled.

Other available options:

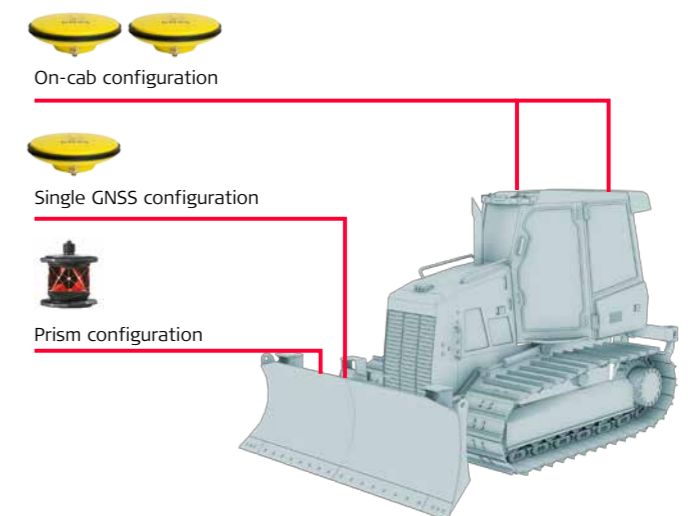

Leica iCON iGD2 – Easy-to-use, yet powerful 2D dozer machine control

The Leica iCON iGD2 dozer solution provides automatic control of both slope and elevation. When using two masts and laser sensors, you can work independently of slope direction.

Leica iCON iGD2 solution for dozers can dramatically increase machine utilisation, boost productivity and optimise material usage on any earthmoving and fine-grading contract. It can be used with a wide range of sensors and combines ease of use and unrivaled flexibility with a very powerful and intuitive user interface.



BENEFITS OF IGD2

- Dedicated grade and slope adjustment keys
- Intuitive graphics show the blade's actual position
- Quick and easy setup for operator preferences
- Auto/Manual control mode selection

Dozer 2D solution

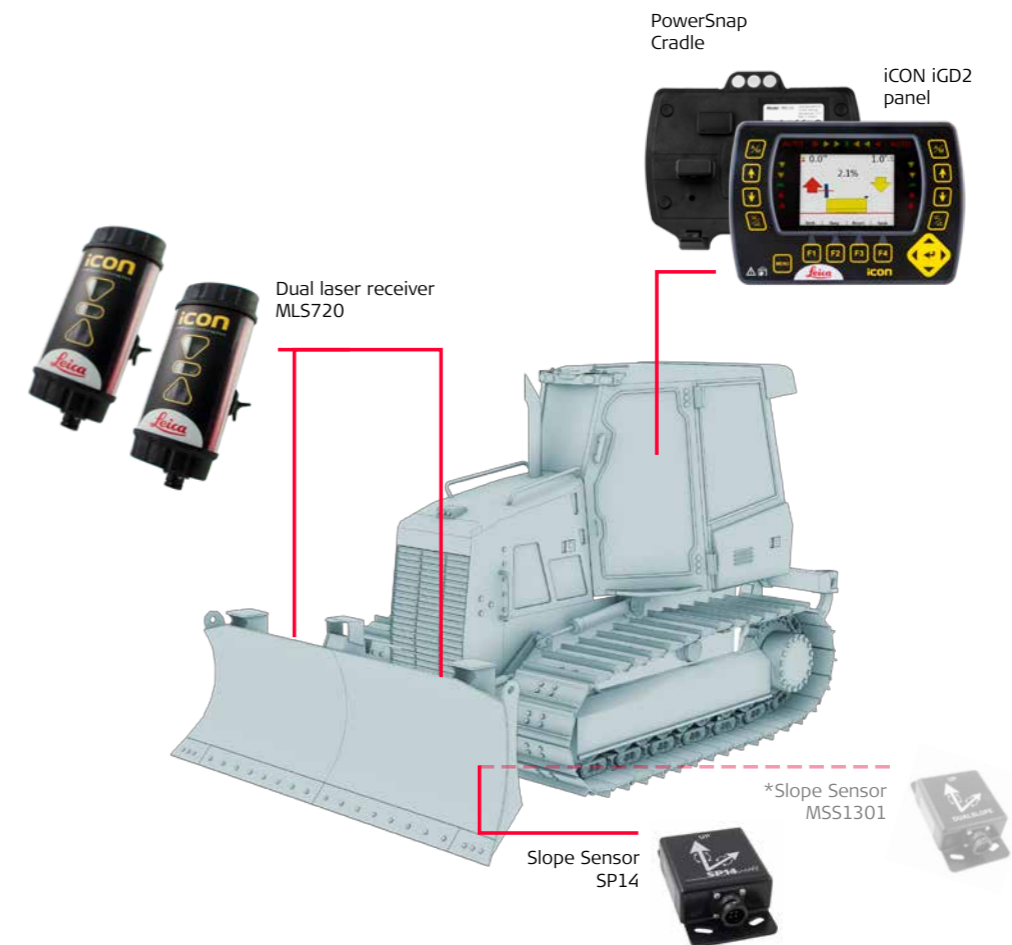

Other available options:

Automatic functions

AUTOMATIC TILT FUNCTION

Be in permanent control over the dozer blade. The MSS1301 inclinometer sensor is mounted on the machine to detect the tilt of the blade.

AUTOMATIC HEIGHT FUNCTION

The laser receivers have a capture angle of 360 degrees. The MLS720 laser receiver is mounted on the mast for obtaining height. iGD2 can be installed with either single or dual laser receivers.

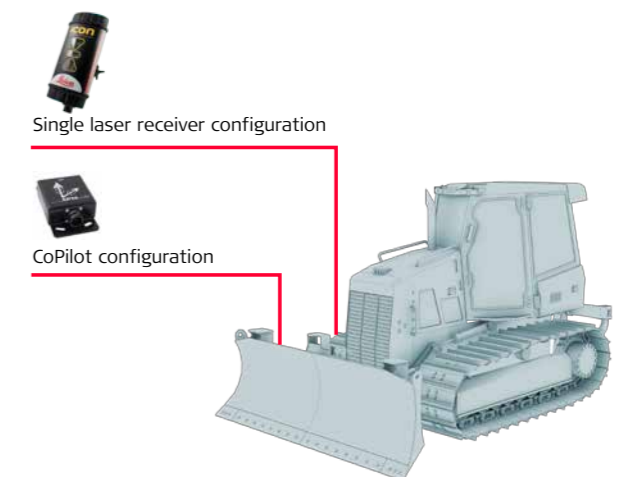

Leica iGD2 CoPilot – Automatic cut/fill control on your dozer

The iGD2 CoPilot software upgrade allows the dozer operator to grade to specification, regardless of their training level. It automatically adjusts critical parameters for more accurate grading results. Make straight, smooth pushes without any waves on all your grading or material moving tasks.



BENEFITS OF IGD2 COPILOT

- Ensures correct grades without washboard surfaces
- Works without a rotating laser, total station, or GNSS
- Less rework, wear and tear, and training effort
- Provides a safer work environment
- Works with 2D

On-Cab configuration - for iGD4^{SP}

The iGD4^{SP} solution is optionally available with on-cab mounted antennae for advanced personnel safety and reduced wear and tear of the equipment. Benefit from increased versatility with customer-focused mounting options. This configuration means that the antennae can be placed on the top of the roof on the cabin instead of on the dozer blade. The advantage of this new configuration is that there are no external masts and cables and gives the operator better visibility.



BENEFITS OF ON-CAB

- No need to climb onto the blade for installation
- Increased field of view for the operator
- Eliminated risk of damage on masts, cables and antennae
- Enhanced versatility – mount the antennae on the blade or onto the cab



Grader solution

When using your grader for anything from cutting ditches to grading side slopes, our machine control solutions for motor graders are at your service. With an easy-to-use, easy-to-learn interface, your operators will work directly from 3D CAD design models right inside the cab. Real-time cut and fill information means fewer passes, less rework, and no surveyor needed to check grade. When you're done, swap your components to another machine or put them away for safety.



Leica iCON iGG2

Our 2D solution for motor graders is the perfect entry point for those looking to get into machine control. Get right to grade the first time.



Leica iCON iGG3 & iGG4^{SP}

Get better insight into your job when you can work from the digital design surfaces and alignments right inside the cab. The perfect solutions for all fine grading applications.

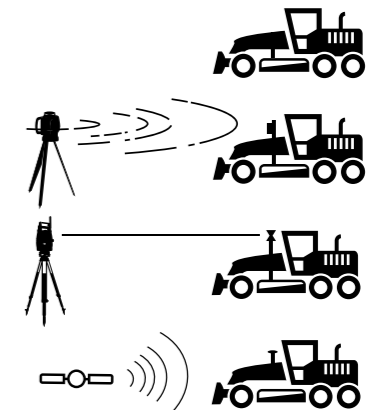

Leica iCON iGG3/iGG4 – efficient and flexible solution

The single or dual GNSS solutions for guided or automatic machine control for motor graders gives the operator a huge range of configurations to fulfil any customer need. Let operators utilise the true potential of their machines for a wider range of applications, by moving materials anyway they want. Operators can now finish jobs faster, with drastically reduced downtime and complete more tasks with their motor grader than ever before.



BENEFITS OF IGG3/IGG4

- Auto/Manual information directly on screen
- User definable views (e.g. Plan View, Cut & Fill View)
- Visible display screen, even in sunlight
- Expand your system simply by adding components

Grader 3D solution

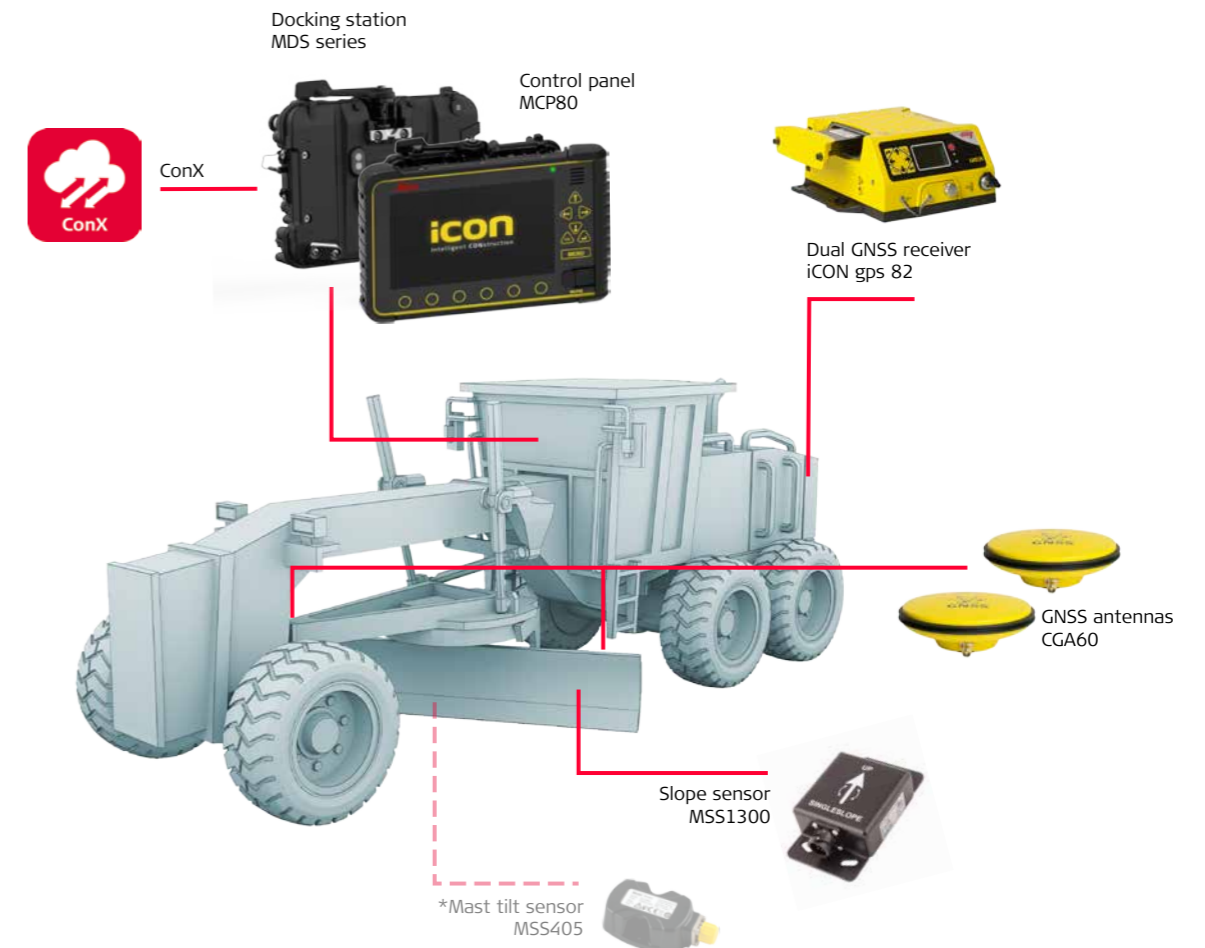

Leica iCON iGG3

Optimise material usage on any earthmoving and fine-grading contract with the iGG3. Bring the design surfaces and alignments virtually in the cab – breaking you free from stakes or hubs. The most efficient and flexible solution for complete automatic motor grader control, the Leica iCON iGG3 delivers millimetre-accurate control of the blade, which is ideal for all fine grading applications.

Other available options:



Single GNSS configuration



Prism configuration

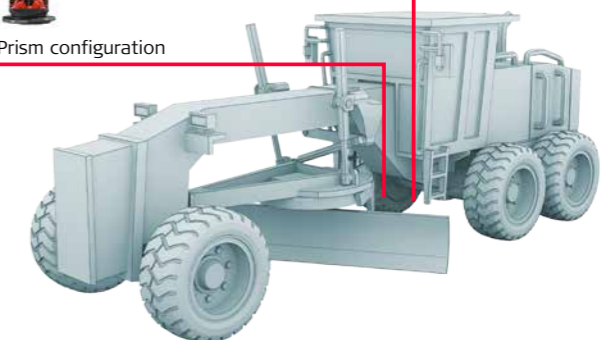

Leica iCON iGG4

The iGG4 machine control solution for motor graders automatically controls the blade while you focus on putting the machine in the optimal position. It watches both ends of the blade for you so you can focus on manual steering.

Leica iCON iGG2 – Scalable 2D entry solution

The iGG2 provides automatic control of both slope and elevation. When using two masts and laser sensors, you can work independently of slope direction. Get to the grade faster than before.



- BENEFITS OF iGG2**
- Easy-to-use graphical display – the same panel is used on your dozer and grader, giving you the ultimate in equipment flexibility
 - Short learning curve thanks to intuitive software
 - The wireless cradle makes it easy to place and remove the panel from the cabin

Grader 2D solution

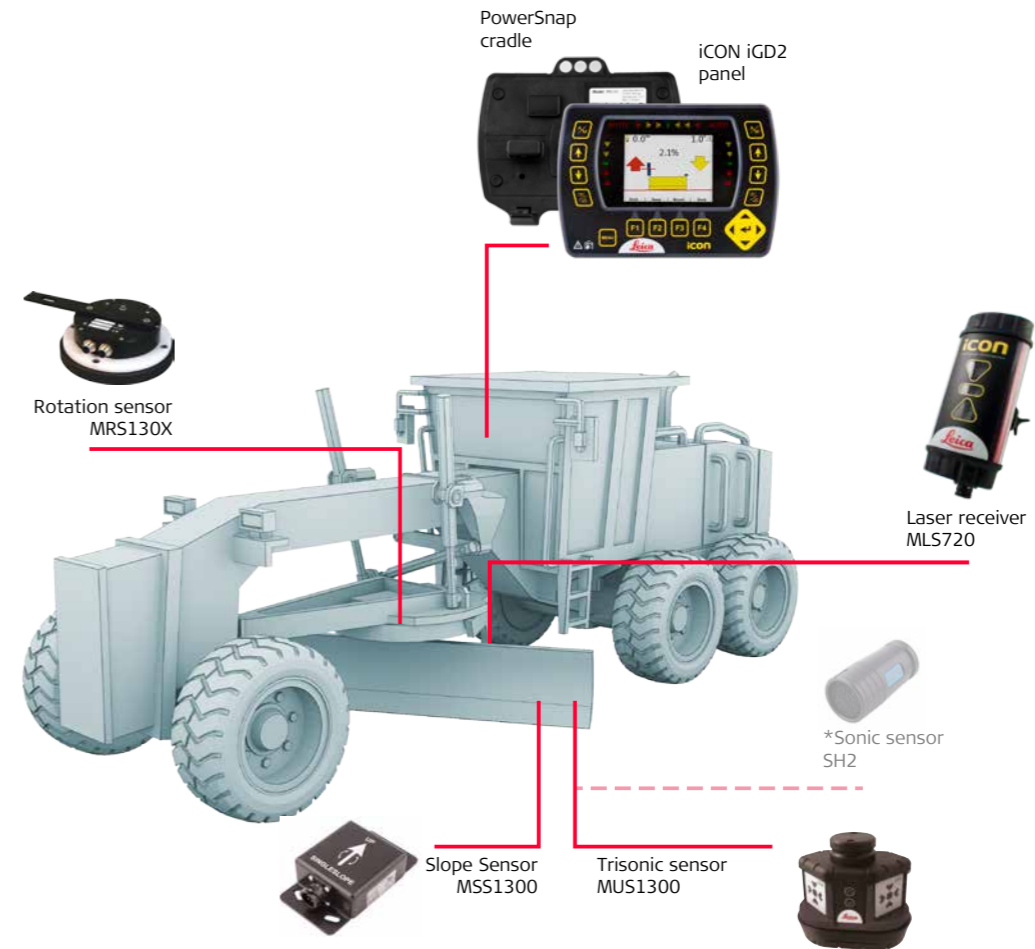

Other available options:



Dual laser receiver configuration

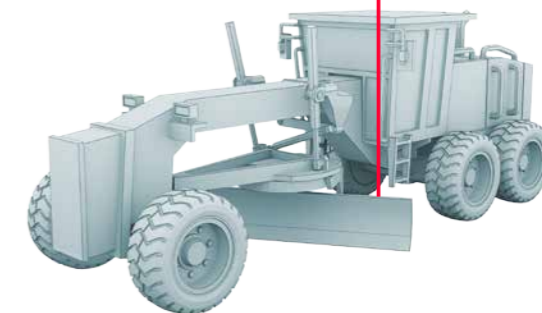

Leica iCON iGG2

The Leica iCON grade solutions for motor graders offer new site preparation possibilities. The system regulates the elevation and cross slope by means of robust and high-tech sensors. The system helps you improve your productivity as well as save material costs.



Wheel loader solution

Keeping your earthmoving tasks efficient safeguards your bottom line. Our solution for wheel loaders provides the operator with precision guidance so that they can get to grade the first time.



Leica iCON iGW3

Make earthmoving with your wheel loader easier by adding 3D machine control. With guidance in the cab, you can make sure you're on grade the first time – saving you time and money on your earthmoving tasks.

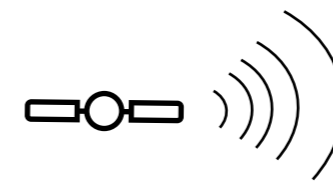

Leica iCON iGW3 – Increased efficiency for wheel loaders

Experience the unique benefits of Leica iCON iGW3 machine control for your wheel loader. Get your earthwork jobs done faster and right the first time. Save time and costs by reducing rework and eliminating over excavating and grade checkings.



Wheel loader 3D solution

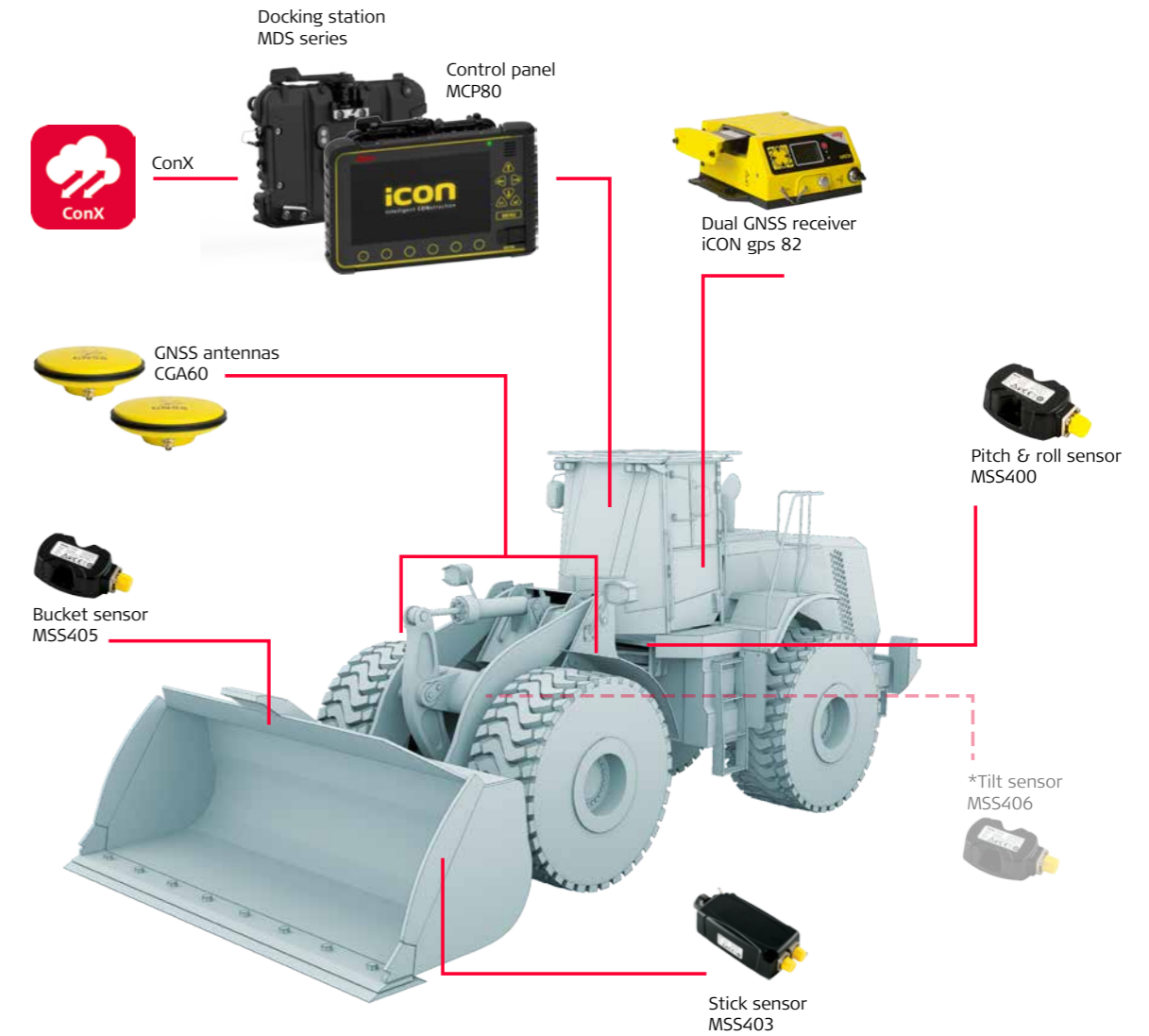

Leica iCON iGW3

The Leica iCON grade iGW3 wheel loader system provides the real-time positioning of the bucket, allowing the operator to apply instantaneous adjustments of the bucket position. The system uses 3D design models and state-of-the-art GNSS technology. Design information and real-time cut and fill indications are displayed on the control panel in the cab for easy and productive operation. The user-friendly interface with graphical colour display provides full guidance and allows easy operation.

BENEFITS OF IGW3

- Maximise your machine utilisation and return on investment from day one - get the grade right from the start
- Eliminate over excavation and costly material overruns
- Operator-friendly user interface reduces training time and cost
- Intuitive user interface provides additional confidence and high productivity
- Reduces labor costs by decreasing or eliminating grade checks



Piler solution

Maximise safety and cost savings with a Leica Geosystems piling solution. High efficiency piling makes you more productive and enables you to use fewer people onsite, allowing you to optimise your resources. With applied documentation being automated, there is no need to survey the finished project. Save time and costs with automated navigation between piles and monitor your project progress through Leica ConX from the comfort of your office. All in all, our piling solution shortens project time and increases your efficiency.



Leica iCON iRP3

The piling solution offers a standard tower or body-mounted GNSS piler configuration in combination with an array of sensors for piling of precast concrete piles, sheet wall and ground stabilisation.

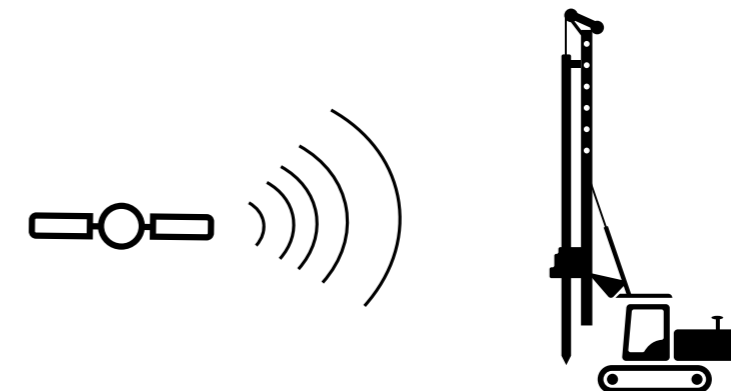

Leica iCON iRP3 – Increase **efficiency** and **productivity** for pilers

The Leica iCON iRP3 solution for pilers maximises productivity in piling applications. Piling rigs can be controlled easily from the cab via the control panel with 3D design plan. There is no need to manually stake out the positions of the piles or sheets.



KEY BENEFITS

- Huge cost savings and increased safety due to less people on the site
- As applied documentation is automated, there is no need to survey the finished project
- Save time and costs with faster navigation between piles
- Check on your projects progress from the comfort of your office
- Complete large piling projects in a short time

KEY FEATURES

- Eliminate stake out – start working immediately
- Document pile positions on-the-fly
- Navigate automatically to nearest pile
- Get real-time status of project with Leica ConX
- Choose between body mounting or tower mounting of GNSS antennae

ICON RIG BENEFITS

- One solution for all your drilling and piling needs
- Built on the same hardware platform as all other iCON solutions, one platform for all your machine control needs
- Connect entire site with ConX
- Simple and intuitive user interface
- Fully customisable 3D views of your machine and jobsite, see the job exactly how you want to
- Quick and easy setup for operator preferences
- No need for office software, the iCON rig software platform accepts several open 3D data formats

Leica iCON iRP3

Export the 3D piling plan, upload it to Leica ConX and transfer the file to the machine and get to work.

The Leica iCON iRP3 piler solution gives you maximum control. Guide your piler via the GNSS antennae and 3D design plans directly in the cab on the display. Automatically documenting the work as the project progresses means there's no need to survey the finished project.

Leica ConX

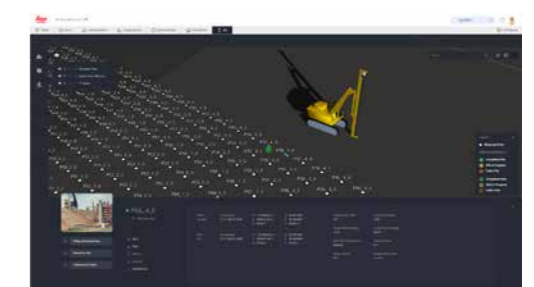

Piler 3D solution

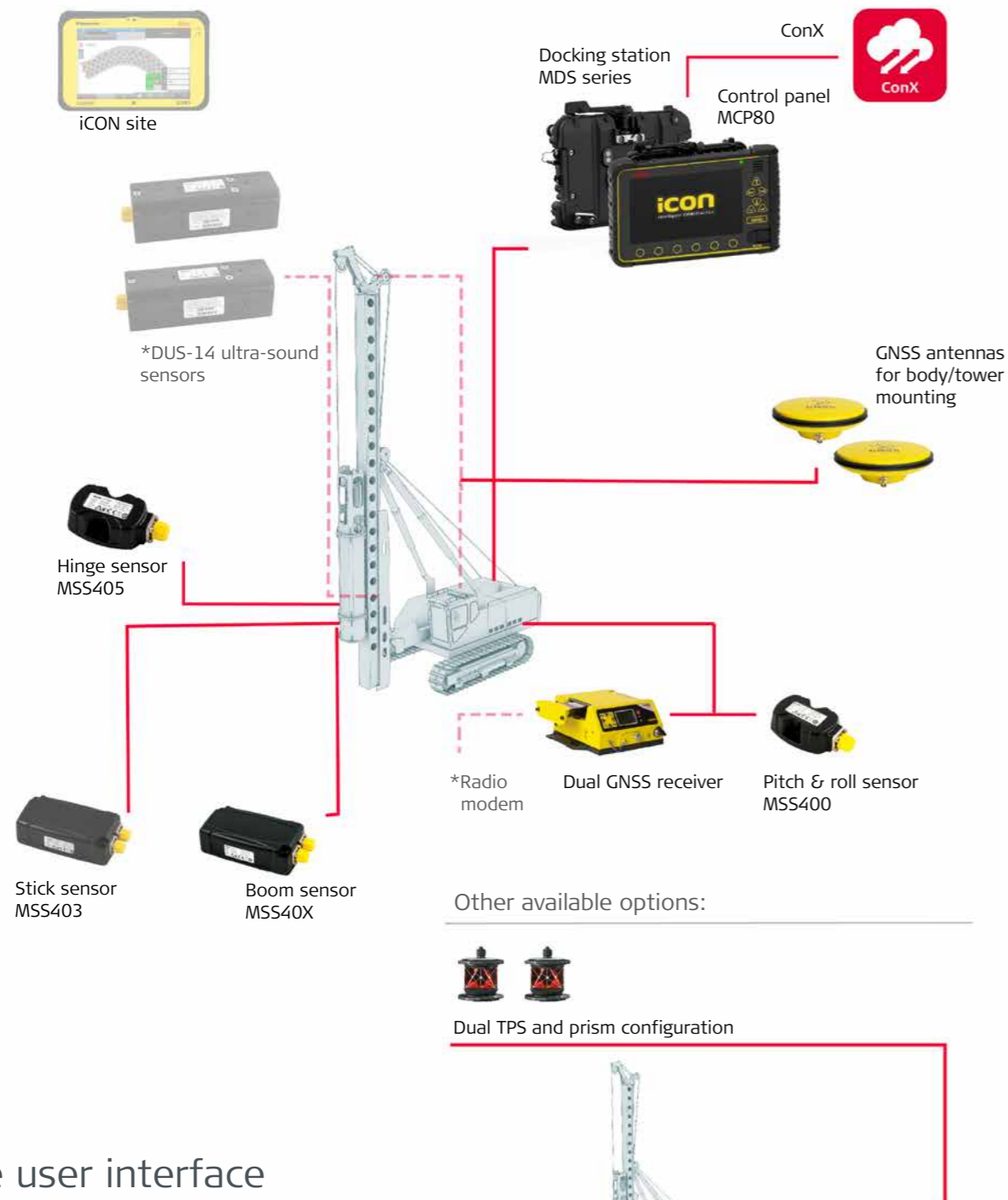

Simple user interface

The user interface in iRP3 is simple and intuitive with icons and help texts. The iRP3 assists the piler operator during the workflow and the run screen can be set up to suit the task at hand.

The interface displays the most relevant functions for pilers in the menu for easy access.

Exact position, precise results



Select run screen



Bull's eye view

Full screen with bull's eye view with the navigation area being collected into one single focus area for the operator. When the operator reaches the target distance to the point, the run screen automatically zooms to the point.



Cylinder view

The operator can choose to show the piler pattern in a colour-coded cylinder view. Green shows that a pile is driven successfully, red shows a failed pile, yellow shows a paused pile and white cylinders show the piles to be piled. The auto-navigation functionality automatically navigates the operator to the nearest pile.



Split screen view

The split screen run screen combines the advantages of both the bull's eye view and the cylinder view. It assists the operator in the piling work and lets the operator keep an eye on the navigation.



Driller solution

Maximise the productivity of your drilling machines by adding Leica Geosystems machine control. Bring the 3D design plan right inside the cab to eliminate the dependency on stake outs. Directly supply the operator with a drill pattern to the machine control panel and navigate via GNSS to your next drilling location. Our innovative drilling solution allows for drilling of complex patterns and even directional drilling. Work with GNSS antennas along with an array of sensors for your drilling tasks.



Leica iCON iRD3

Leica iCON iRD3 offers a standard tower or body-mounted GNSS driller in combination with multiple sensors for surface drill rigs.

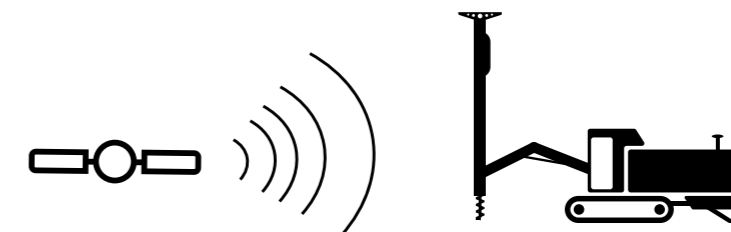

Leica iCON iRD3 – Increase performance, accuracy and safety for drillers

The imported or created drill pattern guides the operator to the closest hole. When the position is within the horizontal tolerances, the operator now only needs to adjust and align the tower so that it fits the chosen hole angle and heading. The navigation is simple: Follow the arrows and numbers on the run screen, and align so that the bull's eye turns green, and you are ready to drill.



KEY BENEFITS

- Huge time and costs savings with every drilling job
- Eliminate or drastically reduce stake out work
- Wireless update of project files and remote support via Leica ConX
- Integration with manufacturers' on-board computer system
- Avoid drilling in old and failed holes

KEY FEATURES

- Drilling complex patterns is a breeze - even directional drilling is possible
- Create drill patterns directly on the display
- Log holes on-the-fly and share with entire site via Leica ConX
- Choose between body mounting or tower mounting of GNSS antennae
- Import drill patterns from Leica iCON site or Leica ConX

ICON RIG BENEFITS

- One solution for all your drilling and piling needs
- Built on the same hardware platform as all other iCON solutions, one platform for all your machine control needs
- Connect entire site with ConX
- Simple and intuitive user interface
- Fully customisable 3D views of your machine and jobsite, see the job exactly how you want to
- Quick and easy setup for operator preferences
- No need for office software, the iCON rig software platform accepts several open 3D data formats

Leica iCON iRD3

The Leica iCON iRD3 driller solution puts you in full control. Guide your driller via the GNSS antennas and 3D design plans directly in the cab on the display. Automatically documenting the work as the project progresses allows you to avoid drilling in old and failed holes.

The Leica iCON iRD3 solution for drills maximises productivity in drilling applications. Drilling rigs can be controlled easily from the cab via the control panel with 3D design plan. There is no need to stake out the positions of the holes to be drilled.

Leica ConX

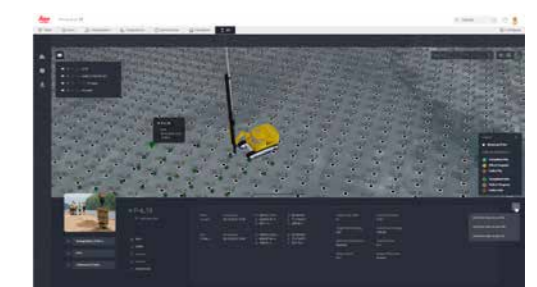

Driller 3D solution

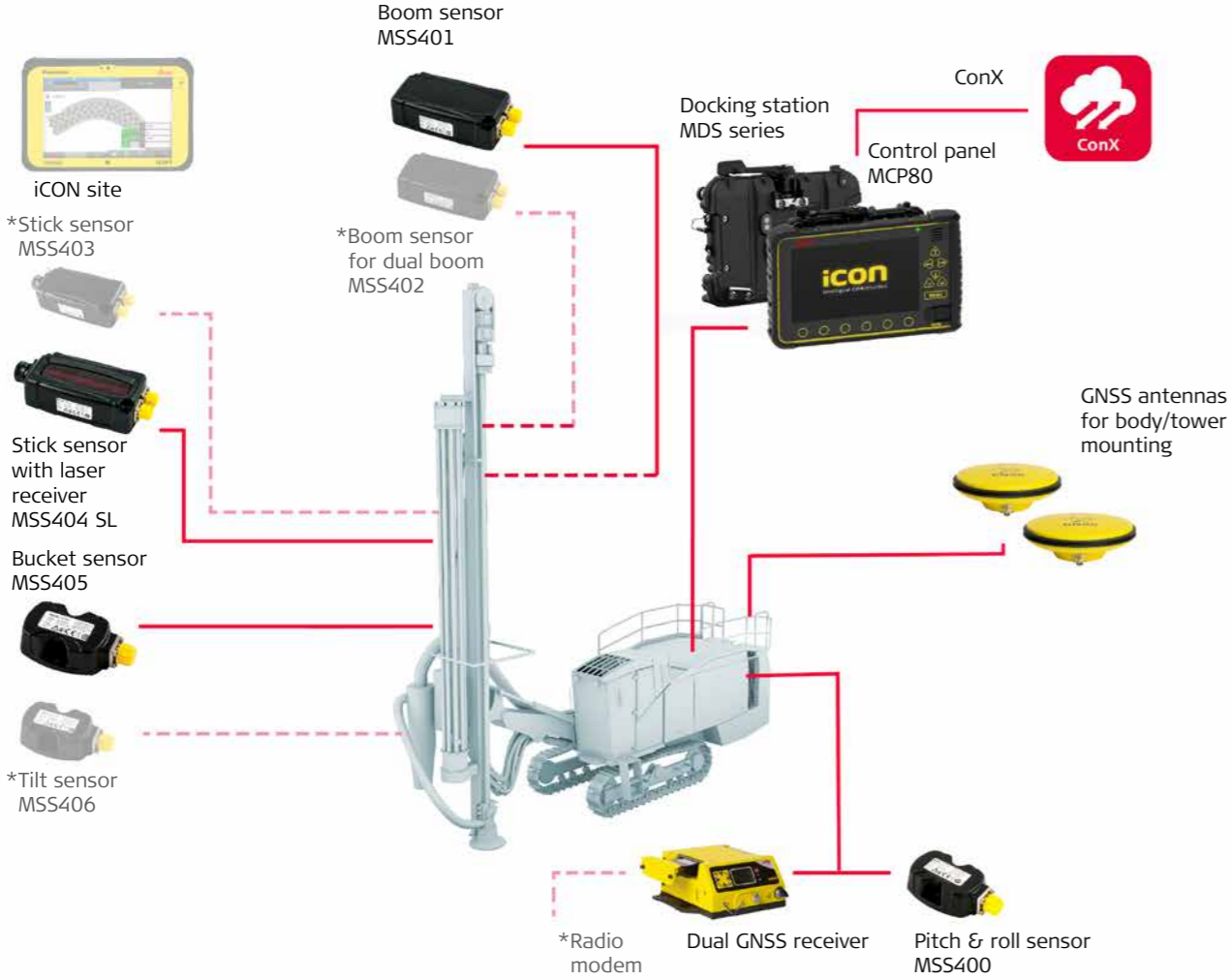

Other available options:



Simple user interface

The user interface in iRD3 is simple and intuitive with icons and help texts. The iRD3 assists the driller operator throughout the entire workflow and the run screen can be set up to suit the task at hand. Use automatic navigation to nearest hole, bull's eye or cylinder view for easy navigation and auto-zoom for increased focus on the task. The interface displays the most relevant functions for drillers in the menu for easy access.

Always in control



Select run screen



Bull's eye view

Full screen with bull's eye view with the navigation area being collected into one single focus area for the operator. When the operator reaches the target distance to the hole, the run screen automatically zooms to the point. Day light and night light modes are available.



Cylinder view

The operator can choose to show the drill pattern in a colour-coded cylinder view. Green shows that a hole is drilled successfully, red shows failed hole and white cylinders show the holes to be drilled. The auto-navigation functionality automatically navigates the operator to the nearest hole.



Split screen view

The split screen run screen combines the advantages of both the bull's eye view and the cylinder view. It assist the operator in the piling work as well as let's the operator keep an eye on the navigation.



Compaction solution

Use the Leica iCON machine control for your soil compactor to get your compaction jobs done faster, more efficient and right the first time. Save time and costs by avoiding over or under compaction. Achieve smooth compaction results every time for a long-lasting foundation.



Leica iCON compaction

With the iCON roller, simplicity is key as it helps to monitor and to document the compaction process while at the same time improving the compaction quality and reducing operational costs.

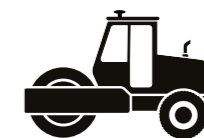
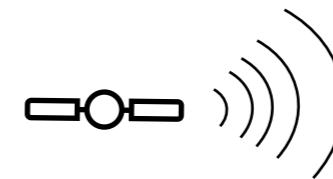

Leica iCON compaction – Achieve higher quality in soil compaction

Experience the unique benefits of Leica iCON machine control solutions in your soil roller. Get your compaction jobs done faster, more efficient and right the first time. Save time and costs by avoiding over or under compaction. Achieve smooth compaction results every time for a long-lasting foundation.

iCON compaction makes the compaction work for the roller operators easier as they can follow the information on the screen to reach the target. The office staff can monitor the compaction progress in real time using Leica ConX.



Simple user interface

Wireless transfer of compaction data to ConX for as-built reporting

Leica iCON compaction for soil rollers is developed to suit the specific needs of the soil compactor operator. The colour-coded mapping visualises the pass counts, and the quick accesses allow the operator to enter the functions that are relevant for the operator's work tasks. The solution interfaces with the cloud-solution Leica ConX for reporting of the quality of work, and data can be exported to advanced post processing programs such as VETA.

KEY FEATURES

- Compaction Meter Value (CMV) sensor implemented in iCON compaction to provide stiffness indication
- Three use cases available: Pass count, CMV target, delta CMV
- Wireless data transfer between site and office for real-time monitoring of work progress
- Job reports for quality control or payment release via Leica ConX
- Export of compaction data in ConX into Veta data format for post process analysis

KEY BENEFITS

- Easy retrofittable for any roller brand and specification
- Versatility by supporting single/dual GNSS and total station position sensors
- Avoid over and under compaction and save fuel, time and rework
- Improved job site planning

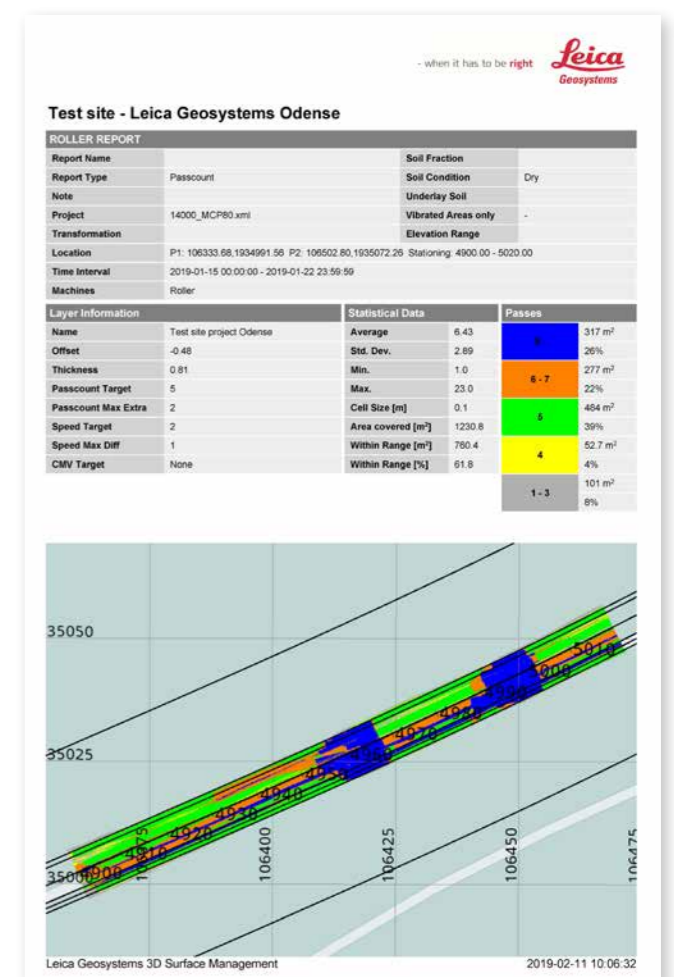



Asphalt paving solution

Save time and costs by avoiding the dependency of string lines. Leica Geosystems offers 3D machine control solutions for any heavy construction application on your construction site. iCON pave makes the paving work for asphalt operator and contractor easier and at lower costs. Stringless asphalt paving increases consistency and quality of the surface.



Leica iCON pave asphalt

Third generation paving solution from Leica Geosystems - the 3D paving pioneer.

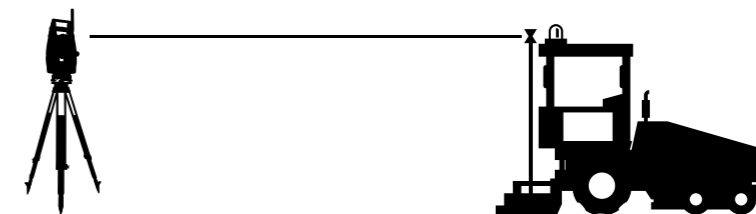

Leica iCON pave for asphalt – 3D machine control for asphalt paving applications

Experience the unique benefits of Leica iCON machine control solutions for your asphalt pavers. Get your asphalt paving job done faster, more efficiently and right the first time. Save time and costs by avoiding the dependency of string lines. iCON pave makes the paving work for asphalt operator and contractor easier and at lower costs. Stringless asphalt paving increases consistency and quality of the surface.



KEY FEATURES

- Stringless paving to reduce costs and shorten project time
- Many sensor combinations possible to suit every paving task
- Track, view and sync via Leica ConX
- Automatic leapfrog for continuous paving to increase quality
- Support all main asphalt paver brands
- High end version includes working width and steering control

KEY BENEFITS

- Asphalt paver ready to pave after reference upload
- Stringline inaccuracy eliminated with consistent paving quality 24/7
- Lower road maintenance costs due to accurate paved surface
- Improved safety for workers on site due to removal of stringlines

PREPARATION

- Upload project data (xml files) via Leica ConX
- Select reference line in project
- Customise the screen

WORK PROGRESS

- Monitor work progress on the panel, and adjust the settings if required
- Perform as-built checks with spare total station
- Reposition total station for automatic leapfrog

QUALITY CONTROL

- Monitor project progress in real time via Leica ConX
- Generate as-built documentation
- Use Leica ConX for remote support

Simple user interface

Assistive user-interface

The Leica iCON pave for asphalt solution is designed to assist the operator through his work tasks. The quick accesses allow the operator to have the most important functions at his fingertips e.g. the simple offset change for elevation and steering, tuning, safety features and selection of total stations. Measured as-built information is sent to the MCP80 panel and then synchronised with Leica ConX.



Milling solution

Experience the unique benefits of Leica iCON machine control solutions for your milling machines. Get your milling job done faster, more efficiently and right the first time. Save time and costs by avoiding the manual work of spraying and typing in of values.



Leica iCON pave for milling

The 3D milling solution from Leica Geosystems ensures a smooth and even milled surface preparing the ground for later asphalt paving, saving time and costly asphalt mix. iCON pave makes the milling work for the operator and contractor easier and at lower costs.

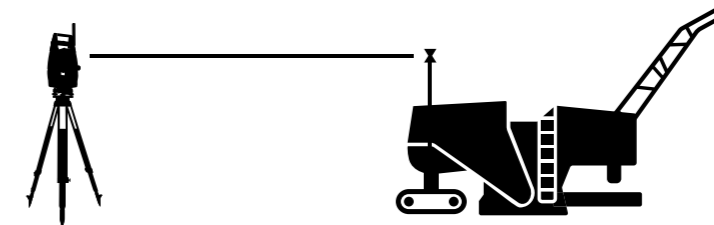

Leica iCON pave for milling – 3D machine control for cold planers

The Leica iCON pave milling solution is designed to assist the operator through his work tasks. The quick accesses allows the operator to have the most important functions at his fingertips e.g. change offset for elevation and set-up of total stations or GNSS. Measured as-built information is sent to the MCP80 panel and then synchronised with Leica ConX.

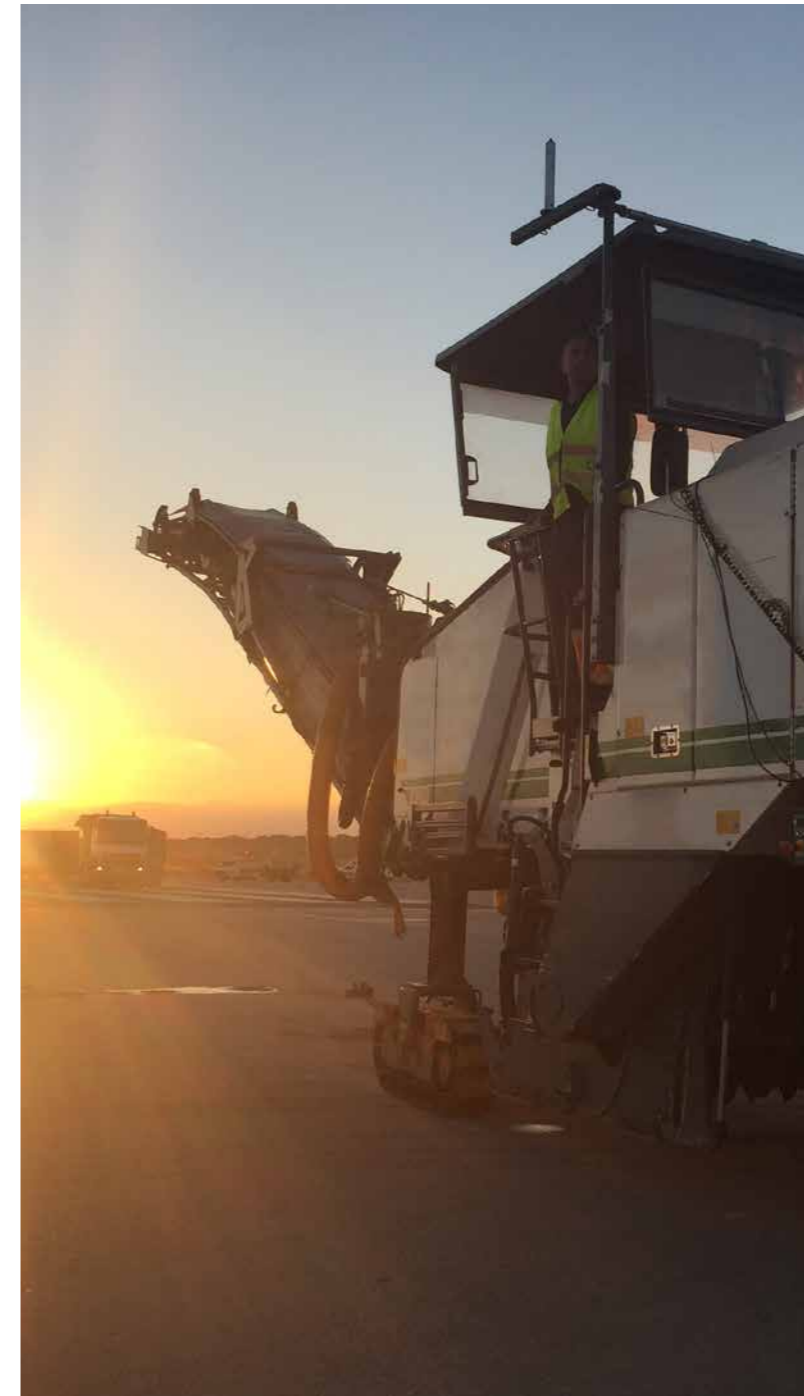

KEY FEATURES

- Automatic leapfrog for continuous work process
- Many sensor combinations possible to suit every milling need
- Track, view and sync via ConX
- Optional patented 1UP sensor configuration for complex projects like race tracks with slope in curves

KEY BENEFITS

- Easy retrofittable for any cold planer brand and specification
- Correct grade and slope without copying effect saving fuel, time and avoiding rework
- Accurate milling surface according to the design model avoids subsequent over paving with costly asphalt mix
- Seamless workflow between milling and asphalt paving to shorten project time
- Improved job site planning and safety on site

PREPARATION

- Upload project data (stringline files) via Leica ConX
- Select reference line in project
- Customise the screen for the required use case
- Position cold planer for milling start

WORK PROGRESS

- Start moving the cold planer and mill automatically to the required level
- Monitor work progress on the panel
- As-built checks with spare total station

QUALITY CONTROL

- Monitor project progress in real time via Leica ConX
- Use Leica ConX for remote support

Leica iCON site milling pilot

Entry-level GNSS milling machine guidance

Leica iCON site milling pilot is your first step into digitised GNSS milling. Control the precise cutting depth and gain from increased productivity, higher precision and smoother surfaces by moving away from traditional methods in the re-paving process. Forget about losses in milling quality resulting from vague or missing spray marks. The iCON site milling pilot calculates the difference between the existing and the design surface at the cold planers' current position. In addition, set values at predicted points ahead of the current position are calculated.





Concrete paving solution

From highways, to tunnels, to airport runways and beyond, the comprehensive Leica Geosystems solution set can be easily configured to your needs with most industry leading paver manufacturers. Its intelligent automation, industry-leading positioning, and intuitive user interface deliver unmatched performance – giving you the edge over your competition.



Leica iCON pave for concrete paving

The ultimate in paving solutions for cold planers, curb & gutter, placer spreader and trimmer machines.

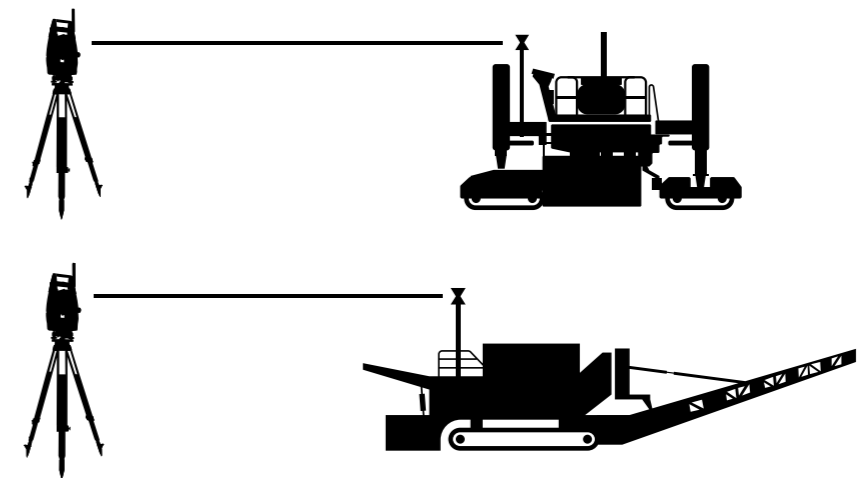

Leica iCON pave for concrete – 3D paving solutions for concrete pavers

Leica iCON pave supports your business with 3D paving solutions from airport paving to tunnel work, curb and gutter jobs or new highway projects. With decades of experience in 3D paving solutions, Leica Geosystems has proven expertise in hundreds of installed and active systems throughout the world and numerous approved interfaces with all main OEMs. Get your paving jobs done faster, more efficiently and right the first time with the concrete paving solution of Leica iCON machine control solution.



KEY FEATURES

- Simplified data transfer within the same platform as all other iCON machine control solutions
- Intelligent hardware combination of panel and at-machine mounted cradle storing machine specific data
- Simple and intuitive user interface
- Smooth workflows due to complete Leica iCON product portfolio for any construction site application
- IUP sensor configuration combining total station and prism with dual GNSS system

KEY BENEFITS

- Consistent and highly accurate pave quality as the third generation of iCON stringless paving solutions
- Easy adaption to any job site conditions with several sensor combinations
- Continuous paving operation with auto leapfrogging of TPS
- Reduced cabling and costs with the new multipoint radio
- Supported by Leica ConX for track, view and synchronisation

PREPERATION

- Upload stringline road models via Leica ConX
- Select reference and slope line on the display
- Customise the run screen
- Activate multipoint radio
- Set up total station (auto leap frog)

WORK PROGRESS

- Monitor material flow while in auto run mode
- Use quick access keys to off-set/tune set safety features for job adaptations

QUALITY CONTROL

- Log as-builts
- Monitor progress in Leica ConX

Simple user interface

Wizards and help functions

The Leica iCON pave solution offers a new machine calibration wizard for easy set-up of the machine. Useful help functions can assist the operator in his work and remote support and communication is helpful tool for the operator to receive information from the site office or from a surveyor. The assistive software ensures better communication and consequently more uptime and productivity.

Customer Care Packages – Maintenance contracts

Leica Geosystems Customer Care Packages (CCP) ensure you achieve maximum value from your investment. When you buy a CCP from Leica Geosystems, you immediately start to benefit from instant access to our network of professional support and service team while you work. With a range of three different Customer Care Packages, you will be sure to obtain the package that best suits your particular requirements and budget. From Basic to Silver, Leica Geosystems has the right Customer Care package for your business.

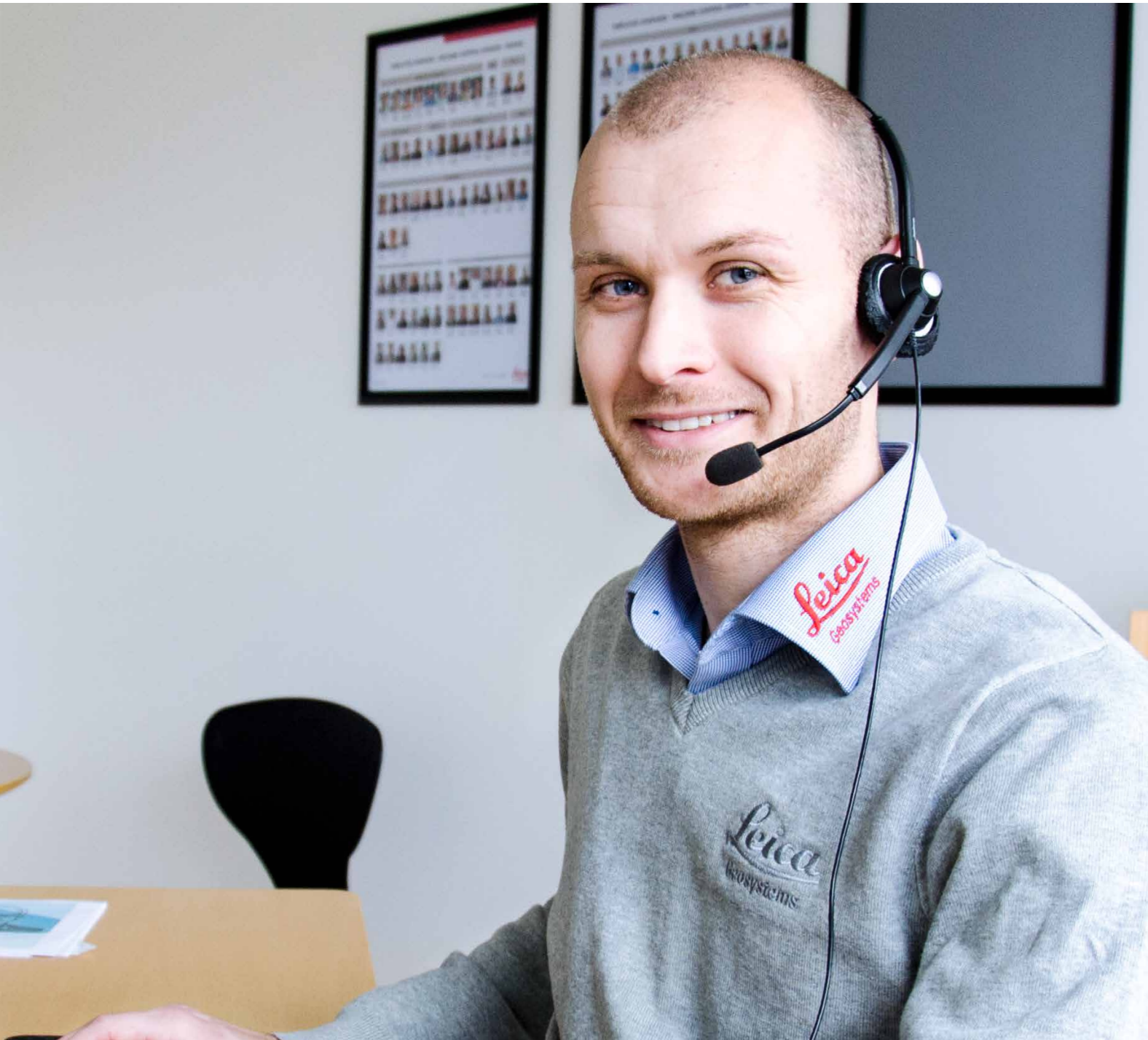

Customer Care PACKAGES >>

The CCPs are Leica Geosystems' maintenance contracts customised for you
1, 2, 3- or 5-years duration

BASIC CCP >> **BLUE CCP >>** **SILVER CCP >>**

	BASIC CCP >>	BLUE CCP >>	SILVER CCP >>
Customer Support	✓	✓	✓
Software Maintenance	✓	✓	✓
Field Service		✓	✓
Extended Warranty			✓



Customer Support

Direct telephone and online access to our machine control professionals. They will work with you to solve any problems that may arise, whether they are operational questions, solution configuration issues or general advice.



Software Maintenance

Benefit from the latest software improvements and new features keep you and your solution up-to-date to maximise productivity. Update your software from myWorld or by talking to your local Leica Geosystems representative about the opportunities.



Field Service

Annual preventative inspection of the solution carried out by experienced technicians minimises repairs, downtime and ensures reliable machines. The annual Field Service inspection includes a visual and a system check and check of the calibration measurements. This gives higher up-time and more reliable machines.



Extended Warranty

Leica Geosystems machine control products come with a standard one-year warranty. The coverage may be extended to a maximum of five years, covering labour and spare parts. An extended warranty provides the additional security of knowing that unplanned costs in the future can be avoided.

Leica Geosystems – when it has to be right

Revolutionising the world of measurement and survey for nearly 200 years, Leica Geosystems is the industry leader in measurement and information technologies. We create complete solutions for professionals across the planet. Known for innovative product and solution development, professionals in a diverse mix of industries, such as surveying and engineering, building and heavy construction, safety and security, and power and plant trust Leica Geosystems for all their geospatial needs. With precise and accurate instruments, sophisticated software, and trusted services, Leica Geosystems delivers value every day to those shaping the future of our world.

Leica Geosystems is part of Hexagon (Nasdaq Stockholm: HEXA B; hexagon.com), a leading global provider of information technology solutions that drive productivity and quality across geospatial and industrial landscapes.



Copyright Leica Geosystems AG, 9435 Heerbrugg, Switzerland. All rights reserved. Printed in Switzerland – 2019. Leica Geosystems AG is part of Hexagon AB. 888095en – 09.19



Leica iCON excavate iXE3 brochure



Leica iCON grade brochure



Leica iCON gps 70 series brochure



Leica iCON pave asphalt flyer