

cimilre S6 Plus

Double Electric Breast Pump Operation Manual



For additional languages, visit
cimilrebreastpumps.com/manuals

Table of Contents

1. Introduction	4
1.1 Key Features	4
1.2 Indications for Use	4
1.3 Explanation of Symbols	5
2. Warnings and Cautions	6-8
3. Components	9
4. Cleaning	10
4.1 Before using your pump	10
4.2 After using your pump	10
5. Assembly	11
6. Pumping	12
6.1 Positioning	12
6.2 Button Controls	13
6.3 Night Light	13
6.4 LCD Screen	13
6.5 Battery Information	14
6.6 Pump Operation	15-16
6.7 Cycle and Suction Settings	16-17
6.8 Massage and Expression Modes	17
7. Breast Shield Sizing	17
7.1 Understanding Size	17
7.2 Test your breast shield size	18
7.3 Determining the right fit	18
8. Breast Milk Storage	19
8.1 How long can I store breast milk?	19
8.2 How do I thaw and use stored milk?	19
9. Troubleshooting	20
10. Disposal	21
11. Technical Information	21
12. Electromagnetic Compatibility	22-25
13. Description of IP Classification	26
14. Warranty	27-28

PLEASE READ THIS MANUAL IN ITS ENTIRETY, INCLUDING ALL INSTRUCTIONS AND WARNINGS, BEFORE USE.

1. Introduction



Congratulations on your decision to provide your baby with breast milk and thank you for choosing the Cimilre S6 Plus breast pump to help you reach your breastfeeding goals. While we hope you enjoy your Cimilre S6 Plus, it is recommended to breastfeed your baby whenever you can. The Cimilre S6 Plus was innovated with moms in mind, as it combines premium quality with a modern design. The Cimilre S6 Plus is a safe, efficient, and effective choice for pumping moms.

1.1 Key Features

- **Double Pumping:** Expressing from both breasts at the same time can save time and supports milk supply.
- **Massage & Expression Modes:** Effortlessly switch from Massage to Expression Mode by pressing a single button.
- **Customized Controls:** Easily adjust suction levels and cycle speeds for maximum comfort and an effective pumping session.
- **LED Night Light:** Choose from three different ambient light levels.
- **Built-in Rechargeable Battery:** With a battery life of 2+ hours between charges, the S6 Plus is portable, allowing for ease of use while pumping on the go.

 Manufacturer	97-14, Seongnam-ro, Mokcheon-eup, Dongnam-gu, Cheonan-si, Chungcheongnam-do, Korea Phone : +82-41-553-0941 Email : cimilre@cimilre.kr
--	--















 Please read this document completely and follow the instructions exactly. To prevent personal injury and material damage, please observe the warning and safety information provided in this document. Identification of danger levels:











 WARNING	Potentially dangerous situation that could result in serious injury.
 CAUTION	A possibly dangerous situation that could result in slight bodily injury
 NOTICE	Useful information or information you need to know when using this product.

1.2 Indications for Use

The Cimilre S6 Plus breast pump is intended to be used by lactating women to express and collect milk from their breasts.

1.3 Explanation of Symbols

Symbol	Description
	Manufacturer
	Date of manufacture
	Serial number
	General prohibition sign
	General warning sign
	Caution
	Notice
	Refer to instruction manual
	Type BF applied part
	CLASS II equipment
	DC
	Alternating current
IP22	Degree of protection against harmful ingress of water or particulate matter. Please see section 11 for the detail information.
	Temperature limit
	US Agent

	Humidity limitation
	Atmospheric pressure limitation
	Keep dry
	Fragile, handle with care
	This product should not be mixed with other commercial waste for disposal.
	Power
	Battery Status
	Adjust the level of suction or cycle
	Changes the operation mode
	LED night light

2. Warnings and Cautions



PROHIBITION: To reduce the risk of electrocution.

- Do not modify this equipment without authorization of the manufacturer.
- Do not disassemble or modify the product. The device has no user-serviceable parts.



WARNING: To reduce the risk of electrocution.

- Always unplug immediately after use.
- Do not use while bathing.
- Do not place or store product where it can fall or be pulled into a tub or sink.
- Do not place or drop into water or other liquid.
- Do not reach for a product if it has fallen into water. Immediately unplug from electrical outlet.



WARNING: To avoid fire, electrocution, or serious burns.

- Do not leave the product unattended when plugged into an electrical outlet.
- Close supervision is necessary when this product is used near children or persons with disabilities.
- Place product out of reach of children.
- Use the product only for its intended use as described in this manual. Do not use attachments not recommended by the manufacturer.
- Never operate this product if it has a damaged cord or plug if it is not working properly, or if it has been dropped or damaged, or dropped into water.
- Keep cord away from heated surface.
- Never use while sleeping or when drowsy.
- Never drop or insert any object into any opening or tubing.
- Do not use outdoors, or operate where aerosol (spray) products are being used or where oxygen is being administered.
- Always inspect power adapter and battery pack wires prior to use for damage or exposed wire. If damage is found, immediately discontinue use of power adapter or battery pack and call Cimilre customer service.
- The CIMILRE S6 Plus should not be positioned so that it is difficult to operate the adapter.



WARNING: To avoid health risk and reduce the risk of injury.

- If you are a mother who is infected with Hepatitis B, Hepatitis C, or Human Immunodeficiency Virus (HIV), pumping breast milk will not reduce or remove the risk of transmitting the virus to your baby through your breast milk.
- Before each use visually inspect the individual components for cracks, chips, tears, discoloration or deterioration. In the event that damage to the device is observed, please discontinue use until the parts have been replaced.
- This product is the intended for use by a single user only and should not be shared between users.
- Do not drive while pumping.
- Never use while pregnant, as pumping can induce labor.
- Clean and sanitize all parts that come in contact with your breast and breast milk prior to first use.
- Wash all parts that come in contact with your breast and breast milk after every use.
- Inspect all appropriate pump components before each use.
- Do not continue pumping for more than two consecutive pumping sessions if no results are achieved.
- Do not thaw frozen breast milk in a microwave or in a pan of boiling water.
- If tube becomes moldy, discontinue use and replace tube.
- If breastmilk backup occurs, you must clean tube and make sure it is dry before your next pumping session.



CAUTION: To avoid minor injury.

- Do not wrap cord around adapter body.
- Use only the power adapter that comes with the powered breast pump.
- Pump only with the breast pump in an upright position.
- Do not shorten tubing.
- Make sure the voltage of the power adapter is compatible with the power source.
- Plug the power adapter into the breast pump first and then into the wall socket.
- Do not use antibacterial or abrasive cleaners/detergents when cleaning breast pump or breast pump parts.
- Never put breast pump motor unit in water or a sterilizer, as you can cause permanent damage to the breast pump.
- Do not attempt to remove the breast shield from your breast while pumping. Turn the breast pump off and break the seal between your breast and breast shield with your finger, then remove breast shield from your breast.
- If pumping is uncomfortable or causing pain, turn the unit off, break the seal between the breast and the breast shield with your finger and remove the breast shield from your breast.
- Plastic bottles and component parts become brittle when frozen and may break when dropped.
- Bottles and component parts may become damaged if mishandled, e.g. dropped, over-tightened or knocked over.
- Take appropriate care in handling bottles and components.
- Do not use the breast milk if bottles or components become damaged.

3. Components

- Cimilre reserves the right to substitute any component or accessory with a replacement of equivalent performance.

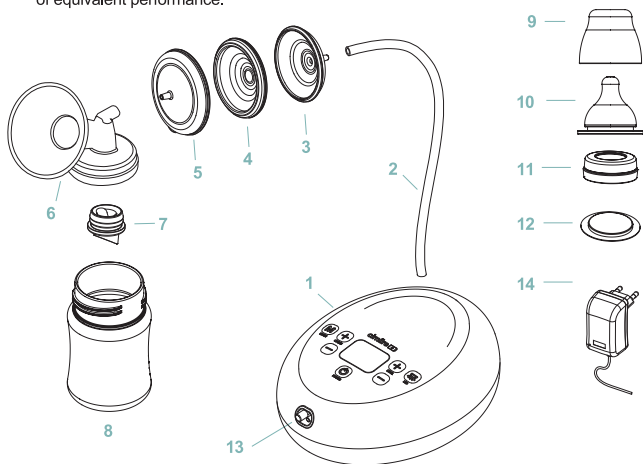

Included Components

1 - Double Electric Breast Pump, Cimilre S6 Plus

2x Milk
Collection Kit

- 2 - Tubing
- 3 - Backflow Protector Top
- 4 - Backflow Protector Silicone
- 5 - Backflow Protector Bottom
- 6 - 24mm & 28mm Breast Shield
- 7 - Valve
- 8 - Bottle
- 9 - Bottle Cap
- 10 - Nipple
- 11 - Bottle Cover
- 12 - Bottle Disk
- 13 - Air Flow Port

14 - Adapter - DC12V, 2A

4. Cleaning

4.1 Before using your pump

Clean and sanitize the parts before using your pump for the first time.

- Backflow protectors
- Breast shields
- Bottles, bottle discs, and bottle covers
- Nipples
- Valves

WARNING: Do not wash or boil tubing. Tubing needs to remain dry to avoid any potential mold contamination.

Cleaning and sanitizing instructions:

1. Only use drinking-quality water or bottled water for cleaning.
2. Wash hands thoroughly.
3. Wash parts with a clean dish cloth or soft brush in warm soapy water.
4. Rinse parts with clear water.
5. Sanitize the parts by placing in boiling water for 5 minutes.
6. Safely remove all parts from water with tongs.
7. Allow all parts to air dry in a clean area.

4.2 After using your pump

Take apart and wash all parts that come in contact with your breasts or breast milk after use to avoid milk residue and bacteria growth.

1. Thoroughly wash your hands before handling each breast pump part.
2. Disassemble each part that comes into contact with breast milk including the backflow protectors, breast shields, bottles, bottle disks, bottle covers, nipples, and valves.
3. Rinse each part in cool water to remove milk residue.
4. Separately wash each part in the sink with a soft brush or clean dishcloth; OR soak each part in warm soapy water for 5 minutes and thoroughly rinse them. Alternatively, place the disassembled parts, except for the tubing, on the top rack of your dishwasher.
5. Dry each part with a clean towel and/or allow them to completely air dry on a sanitary surface.
6. Wipe the main body with a dry, clean towel after each use.
7. Store completely dry parts in a clean bag or container. Do not store any damp parts.

We recommend to sanitize all parts that come in contact with your breast and breast milk daily.

5. Assembly

1. Wash hands before touching breast pump parts.
2. Place breast pump on a clean, dry, and secure surface.
3. Insert the backflow protector silicone membrane into the backflow protector bottom (the part that connects to the breast shield). Ensure that it fits securely and that the backflow protector silicone edge fits around the rim of the backflow protector bottom.
4. Snap on the backflow protector top (the component that connects to the tubing) to the assembled backflow protector bottom.
5. Push the valve onto the underside of the breast shield.
6. Connect the backflow protector assembly to the top of the breast shield. Use a twisting motion to attach, and later remove this assembly, to avoid damaging it.
7. Screw the bottle onto the underside of the breast shield.
8. Connect the tubing to the backflow protector assembly and connect the other end of the tubing to the Cimilre S6 Plus (for single pumping attach the cap on one of the air flow ports).
9. Attach power adapter to the Cimilre S6 Plus.
10. Plug power adapter into a standard electrical outlet.

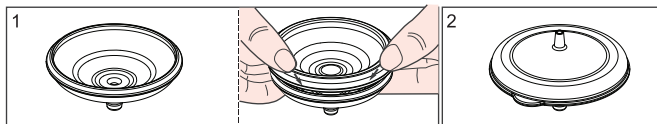

1. Insert silicone membrane into lower protector.
2. Snap on the protector top to the assembled protector bottom.

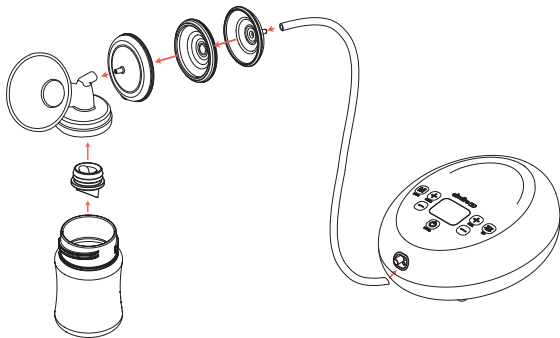

6. Pumping

Gently massage your breasts from the breast toward the nipple or apply warm compresses before using. Express milk from each breast for 10-15 minutes. It is recommended to pump frequently rather than pumping for a long duration. (Every 2-3 hours, 8 times a day).



Consult with your health care provider regarding recommendations for breastfeeding, including breastfeeding while pumping.

6.1 Positioning

1. Before pumping, get into an upright position to prevent milk from back flowing and maintain that position throughout your pumping session.



(✓)



(X)



(X)



(X)

2. Center the breast shield on your breast so that the nipple is drawn into the flange.

It is important that the breast shield is positioned properly before pumping begins to avoid any pain that may be caused by rubbing or twisting of your nipple onto the side of the flange. If double pumping, place the second breast shield in place.

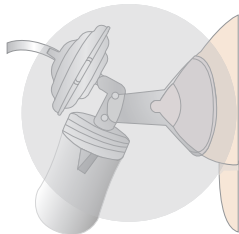

While some discomfort may be felt when first using a breast pump, using a breast pump should not cause pain. If you are unsure about breast shield sizing, please contact a Lactation Consultant or Cimilre representative who can help you get a proper fit.



When pump is powered on for the first time after unboxing, the suction may be preset to a higher level than desired. Adjust the level to a preferred setting before first use.

6.2 Button Controls

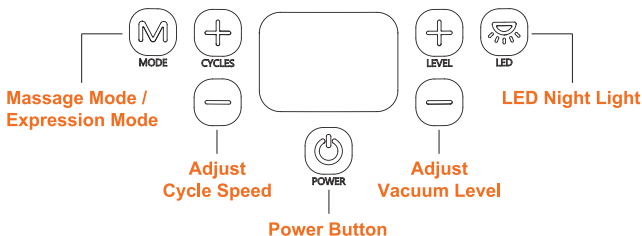

6.3 Night Light



- The LED light appears by pressing the button.
- Select one of three lighting levels.



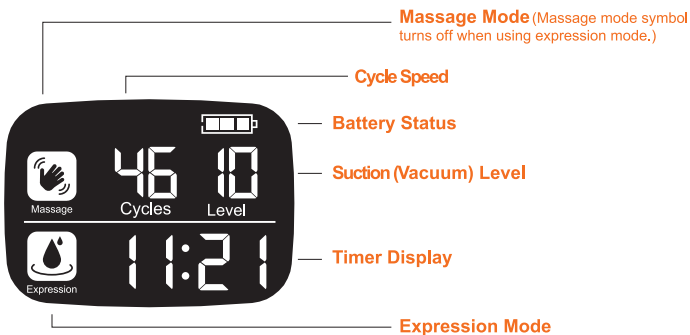

6.4 LCD Screen



6.5 Battery Information

No.	Description
1	Operating time: Approx 3 hours
2	When Charging - Bars flash progressively inside the battery indicator to show that the pump is charging.
3	Fully Charged - Battery indicator shows 3 full bars and the outline of the battery blinks continuously.

Battery Icon - Different Levels of Charge

			
Low Battery	1/3 Charge - Connect AC Adapter Soon	2/3 Charge	Full Charge



When using the AC adapter, the battery will be charged even while pump is in use.

6.6 Pump Operation



When the pump is powered on for the first time after unboxing, the suction may be preset to a higher level than desired. Adjust the level to a preferred setting before first use. After first use, the Cimilre S6 Plus will automatically remember your last settings for your next pumping session.

1. Wash your hands before touching breast pump and parts.

2. To Double pump, remove the plug from the air flow port and connect the tube from the extra collection kit.

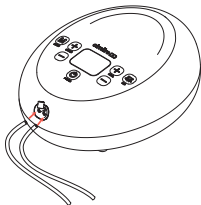

3. If you want to Single pump, make sure to cover one of the air flow ports with the plug.

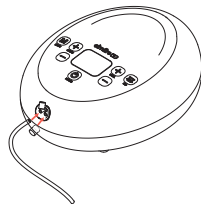

4. To begin pumping, press the Power button on top of the pump. The device will power ON, indicated by the screen lighting up.

Press the Mode button to begin your pumping session in Massage Mode, which will help initiate a faster letdown.

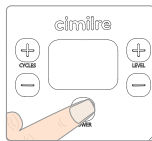

5. Press the Mode button to change to Expression Mode once your milk starts flowing.

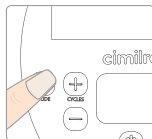

6. Adjust cycle speed using the + - level buttons to preferred suction speed.

7. Adjust suction (vacuum) strength using the + - level buttons to preferred comfort level.



8. When you wish to stop expressing, press the Power button and then remove the milk collection kit from your breast.

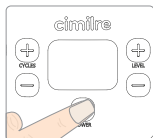

9. Close the bottle(s) tightly with bottle disk and cover, and store safely.

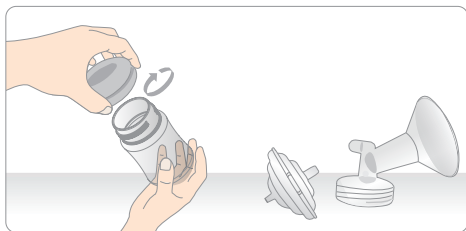

6.7 Cycle and Suction Setting

1. The Cimilre S6 Plus will automatically remember your last settings for your next pumping session. If you want to start pumping on different settings, adjust the settings before you start expressing.
2. The suction (vacuum) level refers to the suction strength; this is measured in millimeters of mercury (mmHg). When you are using the Cimilre S6 Plus, you will usually find that expressing is most effective on the highest suction level that is comfortable for you.

However, it's important not to set suction level so high that it makes you uncomfortable or causes pain as this can hinder your milk flow.



While some discomfort may be felt when first using a breast pump, using a breast pump should not cause pain. If you are feeling strong discomfort or pain while using the breast pump or unsure about breast flange sizing, immediately stop use and contact a healthcare professional.

3. Both cycle and suction can be adjusted in expression and massage mode.

Press the + - buttons on the left side of the screen to adjust the **cycle** settings.

Press the + - buttons on the right side of the screen to adjust the **suction** settings.



6.8 Massage and Expression Modes

Massage Mode: Suction pattern with fast cycle speed and low suction to help encourage a letdown and to start milk flowing.

Expression Mode: Suction pattern with slower cycle speed and higher suction to express milk gently and efficiently.

7. Breast Shield Sizing

7.1 Understanding Size

Pumping should not hurt. This guide is a starting point to help determine your optimal size based on your nipple diameter.

How to find the right size flange for you:

Step 1: Using a ruler or measuring tape, measure the diameter of your nipple at base (across middle) in millimeters (mm).
* 1cm = 10mm. Do not include areola.

Step 2: Take your measurement and add 4mm to determine your breast shield size.
*Example: If your nipple size measures 26mm in diameter, the recommended breast shield size is 30mm.

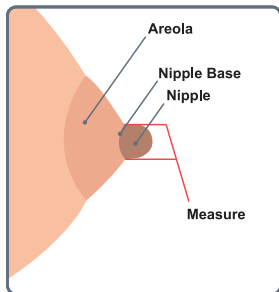

7.2 Test your breast shield size

Good Fit

During pumping, your nipple is able to move freely in the flange tunnel. You will have space around your nipple and not much of the areola is drawn into the tunnel with the nipple.

Too Small

During pumping, some or your entire nipple rubs against the sides of the flange tunnel.

Too Large

During pumping, more of your areola is drawn into the breast pump flange with your nipple. You may experience your areola rubbing up against the side of the flange tunnel.

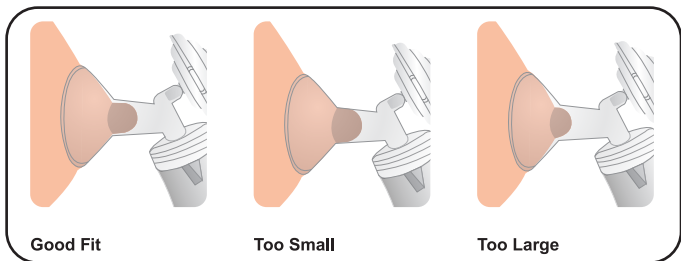

7.3 Determining the right fit

- Does your nipple rub the sides of flange tunnel to the point of causing discomfort?
- Do you see excessive areola being pulled into tunnel?
- Do you see any redness?
- Is your nipple or areola turning white?
- Do you feel unexpressed milk after pumping?

If you answered 'YES' to any of these questions, consider trying a new size by following the measuring instructions above. If you are still unsure if you selected the correct size, see a lactation consultant, or breastfeeding specialist for assistance in choosing the right size breast shield.

8. Breast Milk Storage

8.1 How long can I store breast milk?

	Storage Locations and Temperatures		
Type of Breast Milk	Countertop 77°F (25°C) or colder (room temperature)	Refrigerator 40°F (4°C)	Freezer 0°F (-18°C) or colder
Freshly Expressed or Pumped	Up to 4 hours	Up to 4 Days	Within 6 months is best Up to 12 months is acceptable
Thawed, Previously Frozen	1-2 hours	Up to 1 Day (24 hours)	Never refreeze human milk after it has been thawed
Leftover from a Feeding (baby did not finish the bottle)	Use within 2 hours after the baby is finished feeding		

Source: cdc.gov

8.2 How do I thaw and use stored breast milk?

1. Always thaw the oldest breast milk first. Remember first in, first out.
Over time, the quality of breast milk can decrease.
2. There are several ways to thaw your breast milk:
 - a. In the refrigerator overnight.
 - b. Set in a container of warm or lukewarm water.
 - c. Under lukewarm running water.
3. Never thaw or heat breast milk in a microwave. Microwaving can destroy nutrients in breast milk and create hot spots, which can burn a baby's mouth.
4. Use breast milk within 24 hours of thawing in the refrigerator (this means from the time it is no longer frozen or completely thawed, not from the time when you took it out of the freezer).
5. Once breast milk is brought to room temperature or warmed after storing in the refrigerator or freezer, it should be used within 2 hours.
6. Never refreeze breast milk once it has been thawed.

Source: cdc.gov

9. Troubleshooting







Condition	Possible Causes	Checks	Solutions
No power	Adapter	Confirm that power cord is not damaged and is connected to standard electrical outlet.	If cord is damaged, order replacement at cimilrebreastpumps.com . Plug into standard outlet. If it is still not working, contact Cimilre at (888) 394-2422.
No suction	Tubing	Check the tubing to make sure it is connected to the air flow ports on the pump.	Connect the tubing to the air flow ports on the pump.
	Valve	Check if they are properly connected to breast shield.	Disassemble and properly reassemble.
	Air Flow Port Cover	Check if the air flow port is closed.	Close unused air flow port with cover.
Low suction	Suction level	Listen for abnormal pump sound/noise.	Contact Cimilre at (888) 394-2422.
	Defective assembly kit	Check the connection of the kit.	Disassemble and reassemble the kit.
	Breast Shield	Examine the breast shield for potential cracks or chips. Check breast shield sizing (see section 7).	Visit cimilrebreastpumps.com to purchase and replace breast shield.
	Valve	Check if there is damage to the valve.	Visit cimilrebreastpumps.com to purchase and replace valve.
Pain	Suction too high	Check the suction level.	Decrease suction level and consult with your lactation consultant or healthcare provider.

10. Disposal



As an electrical and electronic equipment, the device must be disposed of according to a specialized procedure for collection, pick-up and recycling or destruction in accordance with Directive 2012/19/EU of the European Council on Waste Electrical and Electronic Equipment [WEEE]. Please properly dispose the Class II medical device in accordance with local, state and federal regulations.

11. Technical Information

Contents	Description	
Rated voltage and frequency	Input: DC 12V, 2A	
Power consumption	0.8A	
Battery / Life	11.1V 2000mAh Li-Polymer / 2 hours +	
Protection on electronic shock	Class II, <input type="checkbox"/> TYPE BF Applied Part 	
Degree of protection against ingress of water	IP Classification: IP22	
Operation mode (Continuous operation)	Expression Mode, Massage Mode	
Suction levels	Expression Mode	1 - 12 Levels
	Massage Mode	1 - 5 Levels
Cycle speeds	Expression Mode	Adjustable (30-46)
	Massage Mode	Adjustable (60-80)
Single/Double	Single/Double	
Timer function	Automatic Off (30 min ± 1 min)	
Noise	Less than 45 dB	
Backflow protection	Yes	
Cleaning method for accessories	Boiling water	
Operating conditions		
Ambient temperature	41 to 104°F	  
Relative humidity	20 to 80 %	
Air pressure	700 to 1,060 hPa	
Transport and storage conditions		
Ambient temperature	-4 to 122°F	  
Relative humidity	20 to 95 %	
Air pressure	500 to 1,060 hPa	

12. Electromagnetic Compatibility

Guidelines and Manufacturer's Declaration – Electromagnetic Emissions

The Cimilre S6 Plus is intended for use in the electromagnetic environment specified in the table below. The customer or the user of the Cimilre S6 Plus should ensure that it is used in such an environment.

Emission test	Compliance	Electromagnetic environment—guidance
RF emission - CISPR 11	Group 1	The Cimilre S6 Plus uses RF energy only for its internal function. Therefore, its RF emissions are very low and are not likely to cause any interference in nearby electronic equipment.
RF emission - CISPR 11	Class B	The Cimilre S6 Plus is suitable for use in all establishments, including domestic establishments and those directly connected to the public low-voltage network that is supplied to buildings used for domestic purposes.
Harmonic emissions IEC 61000-3-2	Class A	
Voltage fluctuations /flicker emissions IEC 61000-3-3	Complies	

Guidance and Manufacturer's Declaration – Electromagnetic Immunity

The Cimilre S6 Plus is intended for use in the electromagnetic environment specified below. The customer or the user of the Cimilre S6 Plus should ensure that it is used in such an environment.

Immunity test	IEC 60601 test level	Compliance level	Electromagnetic environment—guidance
Electrostatic discharge (ESD) IEC 61000-4-2	± 6 kV contact ± 8 kV air	± 6 kV contact ± 8 kV air	Floors should be wood, concrete or ceramic tile. If floors are covered with synthetic material, the relative humidity should be at least 30%.

Electrical fast transients IEC 61000-4-4	± 2 kV for power supply lines ± 1 kV for input/ output lines	± 2 kV for power supply lines	Mains power quality should be that of a typical commercial or hospital environment.
Surges IEC 61000-4-5	± 1 kV differential mode ± 2 kV common mode	± 1 kV differential mode ± 2 kV common mode	Mains power quality should be that of a typical commercial or hospital environment.
Voltage dips, short interruptions and voltage variations IEC 61000-4-11	< 5% U_T (> 95% dip in U_T) for 0.5 cycle 40% U_T (60% dip in U_T) for 6 cycles 70% U_T (30% dip in U_T) for 30 cycles < 5% U_T (>95% dip in U_T) for 5 s	< 5% U_T (> 95% dip in U_T) for 0.5 cycle 40% U_T (60% dip in U_T) for 6 cycles 70% U_T (30% dip in U_T) for 30 cycles < 5% U_T (>95% dip in U_T) for 5 s	Mains power quality should be that of a typical commercial or hospital environment. If the user of the Cimilre S6 Plus requires continued operation during a power interruption, it is recommended that the Cimilre S6 Plus be powered from an uninterruptible power supply.
Power frequency (50/60 Hz) magnetic field IEC 61000-4-8	± 1 kV differential mode ± 2 kV common mode	± 1 kV differential mode ± 2 kV common mode	Power frequency magnetic fields should be measured in the intended installation location to ensure that it is sufficiently low.
NOTE. U_T is the AC mains voltage prior to application of the test level.			

Conducted RF IEC 61000-4-6	3 Vrms 150 kHz to 80 MHz	3 Vrms	Portable and mobile RF communications equipment should be used no closer to any part of the device, including cables, than the recommended separation distance calculated from the equation applicable to the frequency of the transmitter.
Radiated RF IEC 61000-4-3	3 V/m 80 MHz to 2.5 GHz	3 V/m	<p>Recommended separation distance</p> $d = 1,2 \sqrt{P}$ $d = 1,2 \sqrt{P} \text{ 80 MHz to 800 MHz}$ $d = 2,3 \sqrt{P} \text{ 800 MHz to 2.5 GHz}$ <p>Where (P) is the maximum output power rating of the transmitter in watts (W) according to the transmitter manufacturer and d is the recommended separation distance in meters (m).</p> <p>Field strengths from fixed RF transmitters, as determined by an electromagnetic site survey, should be less than the compliance level in each frequency range^b. Interference may occur in the vicinity of equipment marked with the following symbol: </p>

NOTE 1. At 80 MHz and 800 MHz, the higher frequency range applies.

NOTE 2. These guidelines may not apply in all situations. Electromagnetic propagation is affected by absorption and reflection from structures, objects and people.

- a. Field strengths from fixed transmitters, such as base stations for radio (cellular/cordless) telephones and land mobile radios, amateur radio, AM and FM radio broadcast and TV broadcast cannot be predicted theoretically with accuracy. To assess the electromagnetic environment due to fixed RF transmitters, an electromagnetic site survey should be considered. If the measured field strength in the location in which the device is used exceeds the applicable RF compliance level above, the device should be observed to verify normal operation. If abnormal performance is observed, additional measures may be necessary, such as reorienting or relocating the device.
- b. Over the frequency range 150 kHz to 80 MHz, field strengths should be less than 3V/m.

Recommended separation distances between portable and mobile RF communications equipment and the Cimilre S6 Plus

The Cimilre S6 Plus is intended for use in an electromagnetic environment in which radiated RF disturbances are controlled. The customer or the user of Cimilre S6 Plus can help prevent electromagnetic interference by maintaining a minimum distance between portable and mobile RF communications equipment (transmitters) and the Cimilre S6 Plus as recommended below, according to the maximum output power of the communications equipment.

Rated maximum output power of transmitter [W]	Separation distance according to frequency of transmitter [m]		
	150kHz to 80MHz $d = 1,2 \sqrt{P}$	80MHz to 800MHz $d = 1,2 \sqrt{P}$	800MHz to 2.5GHz $d = 2,3 \sqrt{P}$
0.01	0.12 m	0.12 m	0.23 m
0.1	0.38 m	0.38 m	0.73 m
1	1.2 m	1.2 m	2.3 m
10	3.8 m	3.8 m	7.3 m
100	12 m	12 m	23 m

For transmitters rated at a maximum output power not listed above, the recommended separation distance (d) in meters (m) can be estimated using the equation applicable to the frequency of the transmitter, where P is the maximum output power rating of the transmitter in watts (W) according to the transmitter manufacturer.

NOTE 1. At 80MHz and 800MHz, the separation distance for the higher frequency range applies.

NOTE 2. These guidelines may not apply in all situations. Electromagnetic propagation is affected by absorption and reflection from structures, objects and people.

13. Description of IP Classification

IPN ₁ N ₂	N ₁	0: Non-protected
		1: Protected against solid foreign objects of 50 mm Ø and greater
		2: Protected against solid foreign objects of 12,5 mm Ø and greater
		3: Protected against solid foreign objects of 2,5 mm Ø and greater
		4: Protected against solid foreign objects of 1,0 mm Ø and greater
		5: Dust-protected
		6: Dust-tight
	N ₂	0: Non-protected
		1: Protection against vertically falling water drops
		2: Protection against vertically falling water drops when enclosure tilted up to 15°
		3: Protected against spraying water
		4: Protected against splashing water
		5: Protected against water jets
		6: Protected against powerful water jets
		7: Protected against the effects of temporary immersion in water
8: Protected against the effects of continuous immersion in water		

14. Warranty

LIMITED MANUFACTURER'S WARRANTY

The manufacturer provides the following limited warranties on the Cimilre S6 Plus:

THE MANUFACTURER PROVIDES A LIMITED 24-MONTH MECHANICAL WARRANTY FOR MAIN PUMP:

The manufacturer provides a LIMITED MECHANICAL WARRANTY that the main pump will be free from manufacturing defects in materials and workmanship under normal personal use for the 24-month period after purchase by the original owner. Proof of purchase (copy of your original receipt, purchase order, or invoice), the date that the product was purchased, and the location of purchase will be required. Replaced or repaired products are warranted only for the period remaining under the initial warranty.

THE MANUFACTURER ALSO PROVIDES A LIMITED 90-DAY WARRANTY FOR ALL OTHER PARTS:

The manufacturer provides a LIMITED WARRANTY that all other parts will be free from manufacturing defects in materials and workmanship under normal personal use for the 90-day period after purchase by the original owner. Proof of purchase (copy of your original receipt, purchase order, or invoice), the date that the product was purchased, and the location of purchase will be required. Replaced or repaired products are warranted only for the period remaining under the initial warranty.

At the manufacturer's discretion, the manufacturer will replace the main pump and/or any part that proves to be defective in material and/or workmanship under normal use and service. PLEASE NOTE: WARRANTIES DO NOT COVER NORMAL "WEAR AND TEAR." This warranty is extended to the original consumer owner only and shall not apply to any products or parts of products which have been (A) Repaired by unqualified persons not using original spare parts or altered in any manner unless previously authorized in writing by the manufacturer; or (B) Damaged as a result of misuse, negligence, accident, or faulty use or maintenance; or (C) Used or stored in a manner contrary to the manufacturer's written instructions; or (D) Damaged by the effects of improper cleaning and/or use of aggressive cleaners. The warranty does not cover misplacement or theft of the breast pump or supplies.

THIS IS THE EXCLUSIVE WARRANTY BY THE MANUFACTURER, WHICH DOES NOT MAKE ANY OTHER WARRANTY OF ANY KIND, INCLUDING BUT NOT LIMITED TO THE IMPLIED WARRANTY OF MERCHANTABILITY.

This breast pump is intended for single-user use only. Sharing a breast pump can cause health hazards and voids the manufacturer's warranty. The user of this product assumes all responsibilities and risks for use of this product. The user should consult with a health care professional before using this or any other equipment.

THIS WARRANTY IS LIMITED IN SOLELY TO THE ABOVE AND THIS WARRANTY AND ANY WARRANTIES IMPLIED BY STATE LAW WILL APPLY ONLY FOR THE APPLICABLE WARRANTY PERIOD SPECIFIED HEREIN. ALSO, THE MANUFACTURER WILL NOT BE LIABLE FOR ANY LOSS, DAMAGE, EXPENSE OR INCIDENTAL OR CONSEQUENTIAL DAMAGES OF ANY KIND, WHETHER BASED ON WARRANTY, CONTRACT OR NEGLIGENCE AND ARISING IN CONNECTION WITH THE SALE, USE OR REPAIR OF THE PRODUCT. SOME STATES DO NOT ALLOW THE EXCLUSION OR LIMITATION OF CONSEQUENTIAL DAMAGE OR LIMITATIONS ON HOW LONG AN IMPLIED WARRANTY LASTS, SO THE ABOVE LIMITATIONS OR EXCLUSIONS MAY NOT APPLY. THIS WARRANTY GIVES YOU SPECIFIC LEGAL RIGHTS, AND YOU MAY ALSO HAVE OTHER RIGHTS WHICH VARY FROM STATE TO STATE. UNLESS OTHERWISE CONTRARY TO STATE LAW GOVERNING THE PURCHASE, THE MANUFACTURER'S LIABILITY WILL NOT EXCEED THE CONTRACT PRICE FOR THE PRODUCT CLAIMED TO BE DEFECTIVE OR UNSUITABLE.

To make a warranty claim visit cimilrebreastpumps.com/warranty.

Please note that items returned without a Replacement Authorization Number will be returned to Sender.

CIMILRE S6 Plus Operation Manual

Cimilre Co., Ltd.

97-14, Seongnam-ro, Mokcheon-eup,
Dongnam-gu, Cheonan-si,
Chungcheongnam-do, Korea
Phone : +82-41-553-0941
Email : cimilre@cimilre.kr

Symmetrical Health, LLC

615 Main Street
Toms River, NJ 08753
Phone: (888) 394-2422
Email: help@cimilrebreastpumps.com