



TABLE OF CONTENTS

1.	IMPORTANT SAFETY INSTRUCTIONS	1
2.	SET UP THE TELEPHONE	2
2.1	Package Contents.....	2
2.2	Location	2
2.3	Connect the Corded Base Station	3
2.4	Install and Charge the Handset Battery.....	4
	Insert photos for speed dial	4
2.5	Base Station Installation options	5
251	Tabletop to Wall Mount Installation	5
252	Wall Mount to Tabletop Installation	6
3.	GET TO KNOW YOUR PHONE	7
3.1	Overview of the Handset.....	7
3.2	Overview of the Corded Base	10
3.3	Overview of the Handset Charger	11
3.4	Base LCD Display.....	12
3.5	Base Menu Structure	13
3.6	Text and Digit Entry Table.....	14
361	English Character Set.....	14
4.	USE YOUR PHONE.....	15
4.1	Make an External Call	15
4.1.1	Preparatory Dialing.....	15
4.1.2	Direct Dialing	15
4.1.3	Call from the Phonebook.....	15
4.1.4	Call from the Call List.....	16
4.1.5	Call from the Redial List.....	16
4.1.6	Call Timer	16
4.2	Make a Call from Direct Access Memory	17
4.3	Answer a Call.....	17
4.4	Volume Boost Function	18
4.5	End a Call	18
4.6	Adjust Earpiece and Speakerphone Volume.....	19
4.7	Mute a Call	19
4.8	Emergency Call without Main Power	20
4.9	Redial the Last Number	20
4.9.1	Redial a Number from the Redial List.....	20
4.9.2	Store a Redial Number into the Phonebook.....	21
4.9.3	Delete a Redial Number.....	21
4.9.4	Delete the Entire Redial List.....	21
4.10	Find the Handset.....	21
4.11	Make an Internal Call	22
4.11.1	Intercom	22
4.11.2	Call All Handsets.....	22
4.11.3	Transfer an External Call	23

	4.11.4	Make a 3-way Conference Call	23
5		PHONEBOOK.....	24
	5.1	Add a New Phonebook Entry	24
	5.2	Search for a Phonebook Entry	24
	5.3	View a Phonebook Entry	24
	5.4	Edit a Phonebook Entry.....	25
	5.5	Delete a Phonebook Entry	25
	5.6	Delete the Entire Private Phonebook.....	25
	5.7	Check the Phonebook Usage.....	26
6		CALLER DISPLAY (NETWORK DEPENDENT).....	27
	6.1	View the Call List.....	27
	6.2	Store a Call List Number into the Phonebook	28
	6.3	Delete an Entry in the Call List	28
	6.4	Delete the Entire Call List.....	28
7		DIRECT MEMORIES KEYS	29
	7.1	Set direct Memory Keys in Handset	29
8		PHONE SETTINGS.....	30
	8.1	Handset Settings.....	30
	8.1.1	Set the Ringer Volume.....	30
	8.2	Base Settings using the Base.....	30
	8.2.1	Clock Settings.....	30
	8.2.2	Set the Ringer Melody for Internal Calls	31
	8.2.3	Set the Ringer Melody for External Calls.....	31
	8.2.4	Set the Ringer Volume.....	31
	8.2.5	De-register a Handset.....	32
	8.2.6	Set the Flash Time.....	32
	8.2.7	Set the Dial Mode	32
	8.2.8	Set the Key Tone	32
	8.2.9	Change the System PIN	33
	8.2.10	Set the Memory Keys.....	33
	8.2.11	Registration	34
	8.2.12	Reset Your Phone	35
9		ANSWERING MACHINE.....	36
	9.1	Switching Answering Machine On/Off.....	36
	9.2	Play Messages on TAM	37
	9.3	Delete all Messages on TAM.....	37
	9.4	Record Memos on TAM	38
	9.5	Answering Machine Settings (Base Only).....	39
	9.5.1	Set the Answer Mode.....	39
	9.5.2	Set TAM language	39
	9.5.3	Record your Outgoing Message (OGM).....	40
	9.5.4	Playback the Outgoing Message (OGM).....	40
	9.5.5	Delete a Personalized OGM (SET OGM to DEFAULT)	41
	9.5.6	Set the Answer Delay.....	41
	9.5.7	Set the Recording Time of Incoming Message	41

9.5.8	Turn On or Off the Base Screening	42
9.5.9	Change the Compression Rate	42
9.5.10	Activate Remote Access	43
9.5.10.1	Change the 4-Digit Remote Access PIN	43
9.5.10.2	Activate or Deactivate the Remote access	43
9.5.10.3	Reset TAM to Default Settings	43
9.5.10.4	Remote Operations	44
10.	TROUBLESHOOTING	45
11.	TECHNICAL SPECIFICATIONS	48
12.	CARE AND MAINTENANCE INSTRUCTIONS	49
13.	GUARANTEE	50
14.	DECLARATIONS	51

1. IMPORTANT SAFETY INSTRUCTIONS

When using your telephone equipment, basic safety precautions should always be followed to reduce the risk of fire, electric shock and injury, including the following:

1. Read and understand all the instructions.
2. Follow all warnings and instructions marked on the product.
3. Unplug this product from the wall outlet before cleaning. Do not use liquid cleaners or aerosol cleaners. Use a damp cloth for cleaning.
4. Do not use this product near water (for example, near a bath tub, kitchen sink, swimming pool).
5. Do not expose the telephone to direct sunlight or extreme cold environment. Do not put the telephone close to a heating source such as radiators, cookers, etc.
6. Do not overload wall outlets and extension cords as this can result in the risk of fire or electric shock.
7. Unplug this product from the wall outlet and refer servicing to the distributor under the following conditions:
 - When the power supply cord or plug is damaged or frayed.
 - If the product does not operate normally by following the operating instructions.
 - If the product has been dropped and the cabinet has been damaged.
 - If the product exhibits a distinct change in performance.
8. Avoid using a telephone (other than a cordless type) during an electrical storm. There may be a remote risk of electric shock from lightning.
9. Do not use the telephone to report a gas leak in the vicinity of the leak.
10. Use only the supplied NiMH (Nickel Metal Hydride) battery pack! The operation periods for the handsets are only applicable with the default battery capacities
11. The use of other battery types or non-rechargeable batteries/primary cells can be dangerous. These may cause interference and/or unit damages. The manufacturer will not be held liable for damage arising from such non-compliance.
12. Do not use third party charging bays. The battery may be damaged.
13. Battery should not be exposed to excessive heat such as bright sunshine or fire and immersed in water.
14. For pluggable equipment, the socket-outlet (power adaptor) shall be installed near the equipment and shall be easily accessible.

Disposal warning

1. When this crossed-out wheeled bin symbol is attached to a product, it means the product is covered by the European Directive 2002/96/EC.
2. All electrical and electronic products/battery should be disposed of separately from the municipal waste stream via designated collection facilities appointed by the government or the local authorities.
3. The correct disposal of your old appliance/battery will help prevent potential negative consequences for the environment and human health.



For more detailed information about disposal of your old appliance/battery, please Contact your city office, waste disposal service or the shop where you purchased the product.

2. SET UP THE TELEPHONE

2.1 Package Contents

The package contains the following items:

- Base station
- Corded handset
- Cordless handset
- Charger with an AC power adapter
- AC power adapter (for base unit)
- NiMH rechargeable battery pack (for handset)
- Telephone line cord (for base unit)
- User's manual

2.2 Location

For maximum coverage and reduce the interference, here are some guidelines you should consider when you place the base unit,

- place it at a convenient, high, and central location with no obstructions between the handset and base unit in an indoor environment.
- place it away from electronic appliances such as televisions, microwave ovens, radios, personal computers, wireless devices or other cordless phones.
- avoid facing radio frequency transmitters, such as external antennas of mobile phone cell stations.
- avoid plugging it into the same circuit as other major household electrical appliances because of the potential for interference. Try moving the appliance or the base unit to another power outlet.

If the reception for a base unit location is not satisfactory, move it to another location for better reception.

Depending on the surrounding conditions as well as spatial and structural factors, the range may be reduced. The range indoors is normally less than outdoors.

2.3 Connect the Corded Base Station

Plug one end of the telephone line cord into a telephone jack or a DSL filter.

If you have DSL high-speed Internet service, a DSL filter (not included) is required.

Route the telephone line cord through this slot.

Click the wall mount bracket securely into the mounting slots for tabletop use.

Plug the other end of the telephone line cord into the telephone jack on the back of the telephone base.

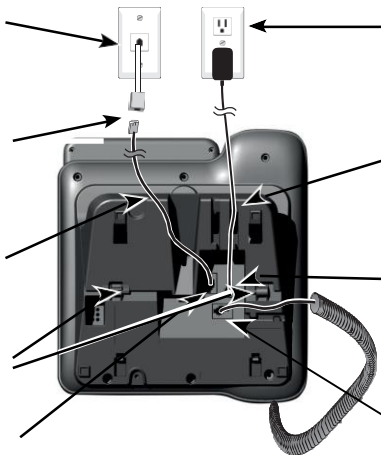

Plug the large end of the telephone base power adapter into a power outlet.

Route the power adapter cord through this slot.

Plug the small end of the telephone base power adapter into the power adapter jack on the back of the telephone base.

Plug the corded handset cord into the corded handset jack on the back of the telephone base.

NOTE

- Use only the power adapter supplied with the base station.



Plug the power adapter into a power outlet.

2.4 Install and Charge the Handset Battery



1. Plug the battery connector securely into the socket inside the handset battery compartment. Insert the supplied battery as indicated.

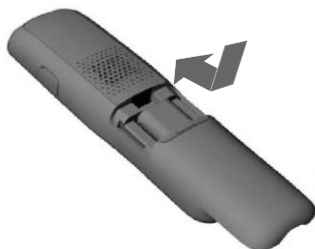

2. Align the cover flat against the battery compartment, and then slide it upwards until it clicks into place.
3. Charge the handset by placing it face forward in the charger. You hear a beep when the handset is charging in the charger.

NOTES

- Use only the supplied NiMH rechargeable battery pack.
- If you do not use the handset for a long time, disconnect and remove the battery to prevent possible leakage.

Insert Photos for speed dial keys

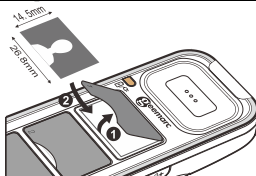

2.5 Base Station Installation options

Your telephone base is ready for tabletop use. If you want to mount your telephone on a wall, follow the steps to connect the telephone base with a standard dual-stud telephone wall mounting plate. You may need a professional to install the mounting plate.

2.5.1 Tabletop to Wall Mount Installation

1. Unplug the power adapter from the power outlet. Unplug the telephone line cord from the wall jack (or DSL filter).
2. Put the corded handset aside. Hold down the switch hook on the telephone base, and then slide the handset tab upwards to remove it from the slot. Rotate the handset tab by 180 degrees. Then, replace the handset tab into the slot until it locks into position.
3. Press down on the tabs of the wall mount bracket to release it from tabletop orientation.
4. Rotate the wall mount bracket down and push it into the telephone base until it clicks into place.
5. Plug the telephone line cord (or DSL filter) into the wall jack. Plug the power adapter into a power outlet. Align the slots on the back of the telephone base with the studs of the wall mounting plate.
6. Slide the telephone base down until it locks securely. Bundle the telephone line cord and power adapter cord neatly with twist ties.

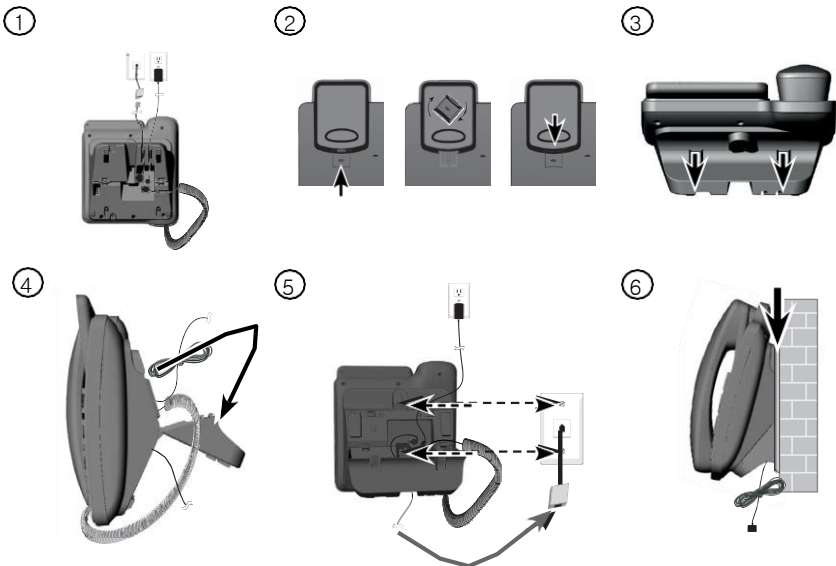

252 Wall Mount to Tabletop Installation

1. Unplug the power adapter from the power outlet. Unplug the telephone line cord from the wall jack (or DSL filter). If the telephone line cord and power adapter cord are bundled, untie them first. Push the telephone base up to remove it from wall.
2. Put the corded handset aside. Hold down the switch hook on the telephone base, and then slide the handset tab upwards to remove it from the slot. Rotate the handset tab by 180 degrees. Then, replace the handset tab into the slot until it locks into position.
3. Gently pull upward to release the wall mount bracket. Rotate the wall mount bracket up to tabletop position and push it into the telephone base until it clicks into place.
4. Plug the telephone line cord (or DSL filter) into the wall jack. Plug the power adapter into an power outlet. Bundle the telephone line cord and power adapter cord neatly with twist ties if necessary.

①

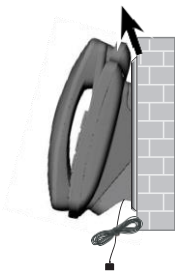

②

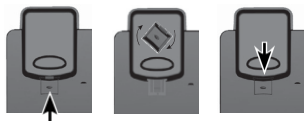

③

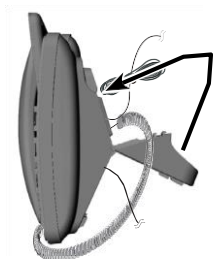

④

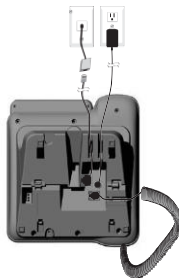

3. GET TO KNOW YOUR PHONE

3.1 Overview of the Handset

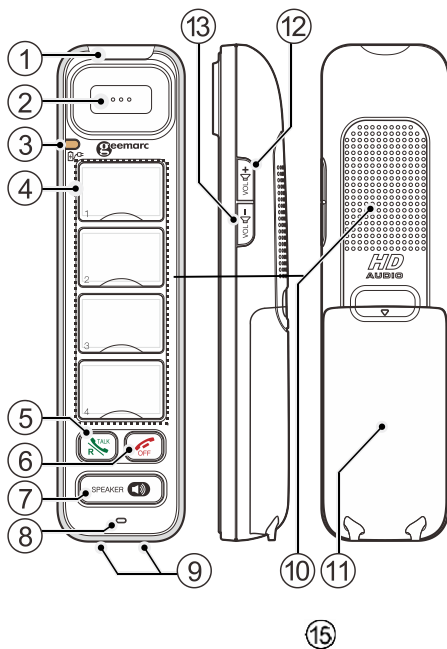

1 Incoming Call light

Flashes red slowly when receiving an incoming call.

2. Earpiece

3. Charger/Booster LED ()

- Steady red when the handset battery is charging.
- Long flashes in red when the handset battery is low.
- Flashes red quickly when handset registration is in progress.
- Flashes red slowly when the handset is not registered or not in charger.
- Steady blue when the booster function is activated.

4. Photo speed dial keys

Your handset has four photo speed dial keys. It retrieves the same set of photo or Direct Memory speed dial entries stored in the AMPLIDECT295 or AMPLIDECT COMBI 295. Press to dial a preset number.

5. Talk ON / Flash ()

- Make or answer a call.
- Light Green when the handset is on earpiece mode.
- During a call, Press to access Recall feature (R).

6. TALK OFF ()

- Hang up a call.
- Silence the ringer temporarily while the phone is ringing.
- Mute the paging tone.

7. SPEAKER ()

- Make or answer a call using the speakerphone.
- Switch between the speakerphone and the earpiece.
- Light Orange when on speakerphone mode.

8. Microphone

9. Charging pole

10. Speakerphone

11. Battery compartment cover

12. VOL+ (VOL +)

- Increase the listening volume up to 30dB amplification, (Or the ringer Volume when in quiescent mode).
- Switch On/Off the receiver Booster function (LED blue).

13. VOL- (VOL -)

Decrease the listening volume. (Or the ringer volume when in quiescent mode (until ringer OFF)).

3.2 Overview of the Corded Base

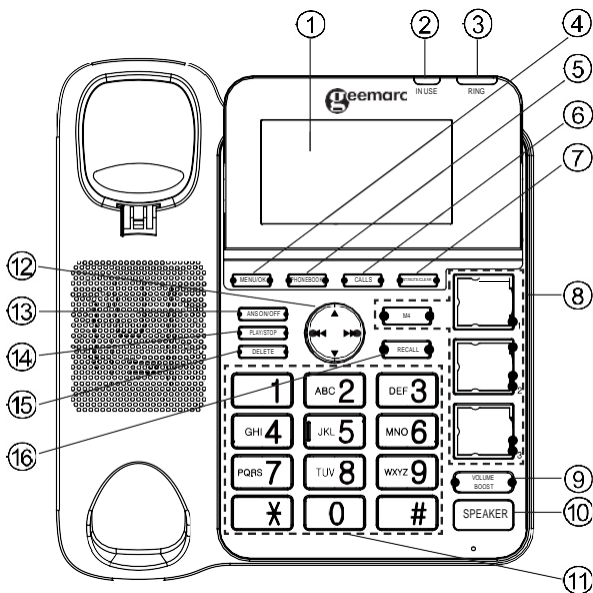

1. LCD DISPLAY

2. IN USE

On during a call.

3. RING light

Flashes when there is an incoming call.

Steadily on when the answering machine is turned on.

Flashes when there are new memos or messages in the answering machine.

4. MENU/OK

In idle mode: Press to access the main menu.

In sub-menu mode: Press to confirm the selection.

In Redial list / Call list: Press to store the number into Phonebook.

5. PHONEBOOK

In Idle: Press to access the phonebook.

6. CALLS (CALL LIST)

In Idle mode: Press to access the call list.

7. INT/MUTE/CLEAR

In main menu mode: Press to go back to idle screen.

In sub-menu mode: Press to go back to previous level.

In sub-menu mode: Press and hold to go back to idle screen.

In editing / predialing mode: Press to clear a character / digit.

In editing / predialing mode: Press and hold to delete all the characters / digits.

During a call: Press to mute / unmute the microphone.

In ringing: Press to silence the base ringer.

In idle mode: Press to intercom another system handset.

8. MEMORY KEYS (3 PHOTO SPEED DIAL KEYS; 1 MEMORY KEY - M4)

In idle mode: Dial your phone number and press and hold the memory key until to hear a beep.

To use: Press to dial out to the number stored in the memory key.

9. VOLUME BOOST

During a call: Press to activate/deactivate the VOLUME BOOST function.

10. SPEAKER

In Idle mode or Phonebook/ Call list/ Redial list view mode: Press to make a call with speakerphone.

11. ALPHANUMERIC KEYPAD, STAR ✕, HARSH

In predial or editing mode: Press to insert a digit / character / L/ J

0 key in predial or editing mode: Press and hold to insert a pause.

12. NAVIGATION KEYS

UP (▲)

In menu mode: Press to scroll up the menu items.

In Phonebook list / Redial list / Call list: Press to scroll up the list.

In editing mode: Press to move the cursor one character to the left.

During a call or TAM message playback: Press to increase the volume.

REPEAT/OGM (◀◀)

In Idle mode: Press and hold to record OGM.

Press to playback OGM.

In TAM message playback mode: Press to go back to previous message.

MEMO/SKIP FORWARD (▶▶)

In Idle mode: Press and hold to record a memo.

In TAM message playback mode: Press to skip to next message.

DOWN/REDIAL LIST (●)

In idle mode: Press to access the redial list.

In menu mode: Press to scroll down the menu items.

In Phonebook list / Redial list / Call list view mode: Press to scroll down the list.

In editing mode: Press to move the cursor one character to the right.

During a call or TAM message playback: Press to decrease the volume.

ANS ON/OFF

In Idle: Press to switch the answering machine ON or OFF.

13. PLAY/STOP

In idle mode: Press to playback messages.

During TAM message playback: Press to stop playing messages.

14. DELETE

In TAM message playback mode: Press to delete the current TAM message playback.

In idle mode: Press and hold to delete all old messages.

15. RECALL

During a call: Press to activate Recall for use with Telephone Network Services

such as Call Waiting during a call.

During message playback: Press to call back the caller if the caller's number is available.

3.3 Overview of the Handset Charger

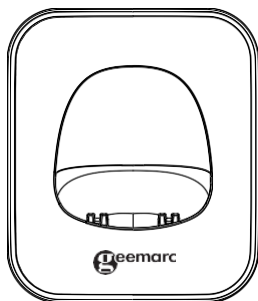





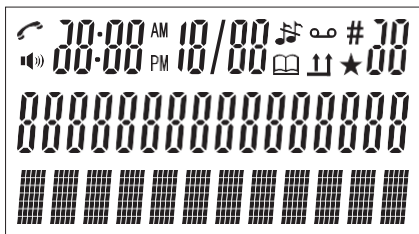

①

1. CHARGING CRADLE

3.4 Base LCD Display

The screen display gives you information on the current status of the telephone.



	This will display when there is a new calls list entry or if one is being viewed.
	Indicate a call is in progress.
	This will display when you are in the phonebook menu.
	This will display when the same caller has called more than once
	Indicate that speakerphone is being used.
#	Indicate the sequence number of the calls list record.
	Indicate that the ringer is switched off.
AM PM	Indicate the time format.

3.5 Base Menu Structure

In idle mode, pressing **MENU/OK** will access the menu. Refer to the following for the menu structure.



Main Menu	PHONEBOOK	CALL LOG	DATE & TIME	LANGUAGE
Sub menu	VIEW ADD EDIT DELETE DELETE ALL PB STATUS	MISSED RECEIVED DIALED	TIME FORMAT SET CLOCK	ENGLISH DEUTSCH FRANCAIS ITALIANO ESPANOL PYCCKNN DUTCH



SETTINGS	PAGE All HS	REGISTRATION	ANS. MACHINE
RING SETUP DELETE HS DIAL MODE FLASH TIME KEY TONE CHANGE PIN BS DEFAULT			MSG PLAYBACK DELETE ALL MEMO TAM ON/OFF TAM SETTINGS ANSWER MODE OGM SETTINGS ANSWER DELAY RECORD TIME TAM LANGUAGE BS SCREENING REMOTE ACC. COMPRESSION CHANGE PIN TAM DEFAULT

3.6 Text and Digit Entry Table

The following tables show you where each letter and punctuation character can be found. This will be helpful when storing a name in the phonebook or renaming your handset.

In editing mode, a cursor is displayed to indicate the current text entry position. It is positioned at the right of the last character entered.

Writing Tips:

1. Once a character is selected, the cursor will move to the next position after a short pause.
2. You can move the cursor within the text by ▲▼ to amend the text entry.
3. Press **CANCEL/MUTE** (☒) on the handset, or **INT/MUTE/CLEAR** on the telephone base, to delete the last character.
4. Press and hold **CANCEL/MUTE** (☒) on the handset, or **INT/MUTE/CLEAR** on the telephone base, to delete the entire text string.

3.8.1 English Character Set

Key	Alphanumeric Editing (For phonebook name editing and renaming handset)										Number Editing (For phone number editing, date / time editing)	
	Key press	1st	2nd	3rd	4th	5th	6th	7th	8th	9th		10th
1	space	-	1									1
2	A	B	C	2								2
3	D	E	F	3								3
4	G	H	I	4								4
5	J	K	L	5								5
6	M	N	O	6								6
7	P	Q	R	S	7							7
8	T	U	V	8								8
9	W	X	Y	Z	9							9
0	0											0, P (Pause)
*	*	?	/	\	()						*
#	#	'	,	-	.	&						#

4. USE YOUR PHONE

4.1 Make an External Call

4.1.1 Preparatory Dialing

Using the base:

Enter the phone number and lift the corded handset or press **SPEAKER** to dial the number. Press **INT/MUTE/CLEAR** to clear the entry when entering the number.

4.1.2 Direct Dialing

Using the base:

Lift the corded handset or press **SPEAKER** to take the line and enter the phone number.

4.1.3 Call from the Phonebook

Using the base:

Press **PHONEBOOK** to access the phonebook and press ▲/▼ to select the desired phonebook entry. Lift the corded handset or press **SPEAKER**  to dial out to the selected phonebook entry.

4.1.4 Call from the Call List

Using the base:

Press **CALLS** to access the call list and press **▲/▼** to select the desired call list entry. Lift the corded handset or press **SPEAKER** to dial out to the selected call list entry.

4.1.5 Call from the Redial List

Using the base:

Press **☎** to access the redial list and press **▲/▼** to select the desired redial number. Lift the corded handset or press **SPEAKER** to dial out to the selected redial number.

4.1.6 Call Timer

Your base automatically times the duration of each call. The call timer will display a few seconds after the call has ended. It is shown in hours, minutes and seconds format (HH:MM: SS).

4.2 Make a Call from Direct Access Memory

Using a handset:

On the handset, press and hold the picture memory until to hear a beep after about 3 seconds.

Or
Press  and press on the picture memory to dial the number pre-stored into the keys respectively.

Using the base:

In idle mode, press any direct memory key in which a number is stored, the phone will automatically dial out the telephone number stored in the selected memory key in speakerphone mode.

OR

Lift the corded handset or press **SPEAKER**, and then press any direct memory key in which a number is stored to dial the number pre-stored into the keys respectively.



NOTES:

- You need to set the direct access number first. See **Section 7.1** for details.
- If no number is stored, you will hear beeps.

4.3 Answer a Call

Using a handset:

If the handset is not on the charging cradle:

When the phone rings, press  or  to answer a call. Press it again to turn on the speakerphone.

If the handset is on the charging cradle: When the phone rings, pick up the handset to answer a call.

Using the base:

When there is an incoming ring, pick up the corded handset or press **SPEAKER**  to answer the call.

4.4 Volume Boost Function

The Volume Boost function allows you to amplify the handset earpiece volume to compensate for the ear's limited sensitivity.

Using a handset:

To turn on the Volume Boost function:

During a call, when in boost mode, you can increase the listening volume up to 30dB amplification.

- Press and Hold (2 seconds) the VOL+ button to activate Boost mode (LED will be steady blue).

To turn off the Volume Boost function and return the earpiece volume back to normal:

- Press and hold again the VOL+ button to cancel Boost mode. (LED will go Off).

NOTE:

The audio boost feature will be turned off automatically when the call is ended.

Using the base:

During a call, you can activate the Volume Boost function with the volume of earpiece increased by several dBs by pressing **AMPLIFY** , "BOOSTER ON" displays on the base screen. To cancel it, press **AMPLIFY**  again.

4.5 End a Call

Using a handset:

During a call, press  to end the call.

OR

Put the cordless handset on the charging cradle to end the call.

Using the base:

During a call, put the corded handset on the base station to end the call.

OR

Press **SPEAKER**  if you have a call in speakerphone mode.

4.6 Adjust Earpiece and Speakerphone Volume

There are 5 levels (VOLUME 1 to VOLUME 5) to choose from for each of earpiece and speakerphone volume.

Using a handset:

During a call:

Press **Vol+** or **Vol-** to select your desired **volume**. When you end the call, the setting will remain at the last selected level.

Using the base:

During a call:

Press **▲/▼** to select **volume 1-5**. The current setting is shown. When you end the call, the settings will remain at the last selected level.

4.7 Mute a Call

With the call muted, you can talk to someone nearby without letting the caller hear you during a call.

Using the base:

During a call:

Press **INT/MUTE/CLEAR** to mute the microphone and "MUTED" is displayed on the LCD. Your caller cannot hear you. Press **INT/MUTE/CLEAR** again to resume the microphone.

4.8 Emergency Call without Main Power

The corded base unit can make an emergency call with the corded handset when the mains AC power is disconnected.

Pick up the corded handset and wait for several seconds to get the dial tone and then enter the phone number to make a call.

REMARK:

It is not possible to dial numbers from memories when the mains power is off.

When the mains power is off, you can also answer an incoming call with the corded handset.





When the phone rings, pick up the corded handset to talk to the caller.

4.9 Redial the Last Number

You can redial up to 10 of the last numbers called on the corded telephone base. If you have stored a name in the phonebook to match with the number, the name will be displayed instead. The most recently dialed number will be displayed at the top of the redial list.

4.9.1 Redial a Number from the Redial List

Using the base:

1. In idle mode, press  to view the redial list.
OR
Press **MENU/OK** and  to select **CALL LOG**.
Press **MENU/OK** and  to select **DIALED**. Press **MENU/OK** to view the redial list.
2. Press  to browse the redial list.
3. Pick up the corded handset or press **SPEAKER**  to dial to the selected redial number.

NOTE:

If there are no numbers in the redial list, the display will show "**EMPTY**".

4.9.2 Store a Redial Number into the Phonebook

Using the base:

1. Follow Steps 1 and 2 in section 4.9.1.
2. Press **MENU/OK** to select **ADD TO PB?**
3. Press **MENU/OK** to enter the name.
4. Press **MENU/OK** to edit the number.
5. Press **MENU/OK** and ▲▼ to select the melody.
6. Press **MENU/OK** to save the redial number into the phonebook.

4.9.3 Delete a Redial Number

Using the base:

1. Follow Steps 1 and 2 in section 4.9.1.
2. Press **MENU/OK** and ▲▼ to select **DELETE?**
3. Press **MENU/OK** to confirm.
4. Press **MENU/OK** to reconfirm. Delete the Entire Redial List

4.9.4 Delete the entire Redial list

Using the base:



1. Follow Steps 1 and 2 in section 4.9.1
2. Press **MENU/OK** and ▲▼ to select **DELETE ALL?**
3. Press **MENU/OK** to confirm.
4. Press **MENU/OK** to reconfirm.

4.10 Find the Handset

This feature helps you find the misplaced handset(s).

You can locate the handset by operation on the base station as below.

1. In idle mode, press **MENU/OK** and ▲▼ to select **PAGE ALL HS.**
2. Press **MENU/OK** to confirm. "PAGING" will flash on the base screen.

All the handsets registered to the base will produce the paging tone, and "PAGING" will flash on the screen. You can stop the paging by pressing  /  /  / **CANCEL/MUTE** on any handset or **INT/MUTE/CLEAR** on the base to stop paging.

NOTE:



If there is an incoming call during paging, the phone will ring with the incoming call instead of paging.

4.11 Make an Internal Call

This feature allows you to make internal calls, transfer external calls and make conference calls. If the called base or handset is not answered within 60 seconds, the called base or handset will stop ringing and the calling one will return to standby mode.

4.11.1 Intercom

Using the corded base:

1. In idle mode, press **INT/MUTE/CLEAR** and ▲/▼ to select the handset you want to call.
2. Press **MENU/OK** to confirm.
3. The called handset rings. Press  or  on the called handset to establish the internal call.

NOTE:

If only one cordless handset is registered to the base station, press **INT/MUTE/CLEAR** will call the cordless handset immediately.

4.11.2 Call All Handsets



Using the corded base:

1. In idle mode, press **INT/MUTE/CLEAR** and press 9.

4.11.3 Transfer an External Call

Using the corded base:

During an external call:

1. Press **MENU/OK** and ▲/▼ to select the desired handset you want to intercom with, then press **MENU/OK**.
2. The external call is put on hold automatically and the called handset rings.
3. Press  or  on the called handset to establish an internal call.
4. Hang up the corded handset on the calling base to end the internal call.
5. The external call is transferred to the called handset.

4.11.4 Make a 3-way Conference Call

The conference call feature allows one external call to be shared with the corded base and cordless handset or two cordless handsets. The three parties can share the conversation and no network subscription is required.

Using the corded base:

During the external call:

1. Follow Steps 1 to 4 in section 4.11.3.
2. Press and hold  on the corded base to establish the conference call.

NOTE:

Any party (corded base or cordless handset) hangs up during a conference call will leave the other party still in connection with the external call.

5 PHONEBOOK

Your phone can store up to 50 private phonebooks in the cordless handset and the telephone base with names and numbers. Each phonebook entry can have a maximum of 20 digits for the phone number and 12 characters for the name.

You can also

select different ringer tones for your phonebook entries. Phonebook entries are stored alphabetically by name.

5.1 Add a New Phonebook Entry

Using the base:

In idle:

1. Press **MENU/OK** to select **PHONEBOOK** main menu item
2. Press **MENU/OK** and **▲ ▼** to select **ADD**.
3. Press **MENU/OK** and enter the name.
4. Press **MENU/OK** and enter the number.
5. Press **MENU/OK** and **▲ ▼** to select the desired ringtone for your phonebook entry.
6. Press **MENU/OK** to store the phonebook entry.

5.2 Search for a Phonebook Entry

Using the corded base:

In idle:

1. Enter the phonebook list.
2. Enter the first character of your desired name of the phonebook entries by multi-tap.

5.3 View a Phonebook Entry

Using the base:

In idle:

1. Press **PHONEBOOK** to display the first phonebook entry in alphabetical order.

OR

1. Press **MENU/OK** three times to display the first phonebook entry.
2. Enter the first character of your desired name of the phonebook entry by multi-tap.

OR

Press **▲/▼** to select and view the desired phonebook entry.

5.4 Edit a Phonebook Entry

Using the base:

In idle:

1. Press **MENU/OK** to select **PHONEBOOK** main menu item
2. Press **MENU/OK** and **▲/▼** to select **EDIT**.
3. Press **MENU/OK** and the display will show the first phonebook entry in alphabetical order.
4. Scroll **▲/▼** until you see the contact you want to edit and then press **MENU/OK**.
5. Edit the name with the key **INT/MUTE/CLEAR** and press **MENU/OK**.
6. Edit the number with the key **INT/MUTE/CLEAR** and press **MENU/OK**.
7. Press **▲/▼** to select your desired ringtone.
8. Press **MENU/OK** to confirm the setting.

5.5 Delete a Phonebook Entry

Using the base: In idle:

1. Press **MENU/OK** to select **PHONEBOOK**.
2. Press **MENU/OK** and **▲/▼** to select **DELETE**.
3. Press **MENU/OK** and **▲/▼** to select the desired phonebook entry.
4. Press **MENU/OK** and the display shows "**CONFIRM?**".
5. Press **MENU/OK** to confirm or **INT/MUTE/CLEAR** to cancel.

5.6 Delete the Entire Private Phonebook

Using the base:

In idle:

1. Press **MENU/OK** to select **PHONEBOOK**.
2. Press **MENU/OK** and **▲/▼** button to select **DELETE ALL**.
3. Press **MENU/OK** and the display shows "**CONFIRM?**".
4. Press **MENU/OK** to confirm or **INT/MUTE/CLEAR** to cancel.

5.7 Check the Phonebook Usage

You can check how many phonebook entries have been occupied in your phone and how many phonebook entries are available for you to store in the phonebook.

Using the base:

In idle:

1. Press **MENU/OK** to select **PHONEBOOK**.
2. Press **MENU/OK** and **▲/▼** to select **PB STATUS**. The display shows "XX/50 USED" (XX refer to the number of phonebook entries). Press **INT/MUTE/CLEAR** to Exit.

6 CALLER DISPLAY (NETWORK DEPENDENT)

This feature is available if you have subscribed the Caller Line Identification service with your network service provider. Your phone can store up to 20 received calls on the cordless handset and the telephone base with date/time information in the call list. The number will be shown on the LCD when the phone is ringing. If the number matches with one of the entries in your Private Phonebook, the caller's name stored in the private phonebook will be displayed with the number. The phone will ring with the melody associated with that phonebook entry.

If the caller number is disabled to send caller information, "WITHHELD" will be displayed.

If the call is an international call or with unknown number, "OUT OF AREA" will be displayed.

In standby, if three unanswered calls are received, "3 CALLS" will be displayed.

6.1 View the Call List

All unanswered calls are saved in calls log with the latest call putting at the top of the list. When the call list is full, the oldest call will be replaced by a new call. The unanswered call which has not been read is marked with ★ icon.

Using the base:

1. Press **CALLS** to access the call list.

OR

1. Press **MENU/OK** and **▲/▼** to select **CALL LOG**.
2. Press **MENU/OK** and **▲/▼** to select **MISSED** or **RECEIVED**.
3. Press **MENU/OK** to see the most recent record in the selected calls list.
4. Press **▲/▼** to scroll through the calls list.

6.2 Store a Call List Number into the Phonebook

Using the base:

1. Follow Section 6.1 to access the call list.
2. Press **MENU/OK** to select **ADD TO PB?**
3. Press **MENU/OK** and enter the name.
4. Press **MENU/OK** and the selected call list number will be displayed.
5. Edit the number if necessary. Use the key **INT/MUTE/CLEAR**  to delete a number.
6. Press **MENU/OK** and **▲▼** to select the melody.
7. Press **MENU/OK** to confirm.

6.3 Delete an Entry in the Call List

Using the base:

1. Follow Section 6.1 to access the call list.
2. Press **MENU/OK** and then **▲▼** to select **DELETE?**
3. Press **MENU/OK** to confirm.
4. Press **MENU/OK** to reconfirm.

6.4 Delete the Entire Call List

Using the base:

1. Follow Section 6.1 to access the call list.
2. Press **MENU/OK** and **▲▼** to select **DELETE ALL?**
3. Press **MENU/OK** to confirm.
4. Press **MENU/OK** to reconfirm.

7 DIRECT MEMORY KEYS

You can store direct memory numbers (**M1** to **M4**) in the corded base. Then, you can dial them directly from idle mode using the Photodect295.

7.1 Set Direct Memory Keys in Handset

On the Corded base

In idle mode:

- 1 Dial your phone number.
- 2 Press and hold the picture memory button to store the number entered from idle mode. You will hear a beep of confirmation.

8 PHONE SETTINGS

Your phone comes with a selection of settings that you can change to personalize your phone the way you like it to work.

8.1 Handset Settings

8.1.1 Set the Ringer Volume

You can set the ringer volume level. A total of 6 ringer volume levels including VOLUME OFF are provided for your selection.

Press on the key **Vol +** and **Vol -** to adjust the ringer volume in idle mode.

8.2 Base Settings using the Base

8.2.1 Clock Settings

You will need to set the correct date and time so that you know when you received answering machine messages or call list entries.

Using the base:

The format for the date is YYYY-MM-DD, and the time is HH:MM in either 12-hour or 24-hour format.

1. Press **MENU/OK** and **▲/▼** to select **DATE & TIME**.
2. Press **MENU/OK** to show **TIME FORMAT**. Select this if you want to change between 12-hour and 24-hour formats. Otherwise, press **▲/▼** to show **SET CLOCK**.
3. Press **MENU/OK** to confirm and the 4-digit year is displayed. Last two digits of the year will flash to ask for year input.
4. Press **▲/▼** to set the year.
5. Press **MENU/OK** and the month field will flash to ask for month input.
6. Press **▲/▼** to set the month.
7. Press **MENU/OK** and the date field will flash to ask for date input.
8. Press **▲/▼** to set the date.
9. Press **MENU/OK** to and the hour field will flash to ask for hour input.
10. Press **▲/▼** to set the hour.
11. Press **MENU/OK** and the minutes field will flash to ask for minutes input.
12. Press **▲/▼** to set the minutes.
13. Press **MENU/OK** to confirm and you will hear a beep with the display back to previous menu.

8.2.2 Set the Ringer Melody for Internal Calls

You can set special melody to personalize your base internal ringer. A total of 10 melodies are provided for your selection.

1. Press **MENU/OK** and **▲/▼** to select **SETTINGS**.
2. Press **MENU/OK** and **▲/▼** to select **RING SETUP**.
3. Press **MENU/OK** and **▲/▼** to select **INT. RING**.
4. Press **MENU/OK** and the display will show **MELODY**.
5. Press **MENU/OK** and **▲/▼** to select the desired ringer melody for internal calls.
6. Press **MENU/OK** to confirm.

NOTE:

The respective ringer melody will be played during your selection.

8.2.3 Set the Ringer Melody for External Calls

You can set special melody to personalize your base external ringer. A total of 10 melodies are provided for your selection.

1. Press **MENU/OK** and **▲/▼** to select **SETTINGS**.
2. Press **MENU/OK** and **▲/▼** to select **RING SETUP**.
3. Press **MENU/OK** and **▲/▼** to select **EXT. RING**.
4. Press **MENU/OK** and the display will show **MELODY**.
5. Press **MENU/OK** and **▲/▼** to select the desired ringer melody for external calls.
6. Press **MENU/OK** to confirm.

8.2.4 Set the Ringer Volume

You can adjust the volume level of the ringer for internal call (INT RING) and external call (EXT RING) separately, with settings from 1 (the quietest) to 5 (loudest), or set it to **VOLUME OFF**.

1. Follow steps from 1 to 3 in section 8.2.2 and 8.2.3
2. Press **MENU/OK** and **▲/▼** to select **VOLUME**.
3. Press **MENU/OK** and **▲/▼** to select the desired volume level list.
4. Press **MENU/OK** to confirm.

NOTE:

The respective ringer volume will be played during your selection. If **VOLUME OFF** is selected,  icon will display.

8.2.5 De-register a Handset

You will need to enter the 4-digit system PIN code in order to de-register a handset from the base station. (The default PIN is 0000.)

1. Press **MENU/OK** and **▲/▼** to select **SETTINGS**.
2. Press **MENU/OK** and **▲/▼** to select **DELETE HS**.
3. Press **MENU/OK** and you are requested to enter the 4-digit system PIN.
4. Enter the 4-digit system PIN.
5. Press **MENU/OK** and a list of registered handsets is displayed.
6. Press **▲/▼** to select one of the handsets that you want to de-register.
7. Press **MENU/OK** to confirm.

8.2.6 Set the Flash Time

The default flash time is best suitable for your country and network operator. It is unlikely that you should need to change this setting unless advised to do so.

1. Press **MENU/OK** and **▲/▼** to select **SETTINGS**.
2. Press **MENU/OK** and **▲/▼** to select **FLASH TIME**.
3. Press **MENU/OK** and **▲/▼** to select the desired flash time (**SHORT**=100ms, **MEDIUM**=300ms, **LONG**=600ms).
4. Press **MENU/OK** to confirm.

8.2.7 Set the Dial Mode

The default dial mode is best suitable for your country and network operator. It is unlikely that you should need to change this setting unless advised to do so.

1. Press **MENU/OK** and **▲/▼** to select **SETTINGS**.
2. Press **MENU/OK** and **▲/▼** to select **DIAL MODE**.
3. Press **MENU/OK** and **▲/▼** to select the desired dial mode (**TONE** or **PULSE**).
4. Press **MENU/OK** to confirm.

8.2.8 Set the Key Tone

The key tone is a confirmation beep when you press any key. It is set on by default, but can be turned off, if desired.

1. Press **MENU/OK** and **▲/▼** to select **SETTINGS**.
2. Press **MENU/OK** and **▲/▼** to select **KEY TONE**.
3. Press **MENU/OK** and **▲/▼** to select **ON** or **OFF**.
4. Press **MENU/OK** to confirm.

8.2.9 Change the System PIN

1. Press **MENU/OK** and **▲/▼** to select **SETTINGS**.
2. Press **MENU/OK** and **▲/▼** to select **CHANGE PIN**.
3. Press **MENU/OK** and you are requested to enter the 4-digit system PIN.
4. Enter the old system PIN.
5. Press **MENU/OK** and enter the new system PIN.
6. Press **MENU/OK** and enter the new system PIN again.
7. Press **MENU/OK** to confirm.

8.2.10 Set the Memory Keys

There are three photo speed dial memory keys **1**, **2**, and **3** and **1** speed dial memory key **M4** on the right side of the telephone base for you to store frequent use numbers.

After a number is stored in any of these memory keys, you can simply press once on one of these memory keys to dial out to the number stored in it directly.

Using the base:

1. In idle mode, enter the telephone number you want to store.
2. Press and hold any of the memory keys until you hear the confirmation tone to indicate the number has been stored.

To insert a photo:

You can insert a desired photo into the compartment of the three photo speed dial memory keys **1**, **2**, and **3**, or write the contact name on the photo speed dial card.

1. Crop your desired photo to the size as indicated below.
2. Put the cropped photo into the photo speed dial compartment. Then flip down the photo speed dial compartment cover.

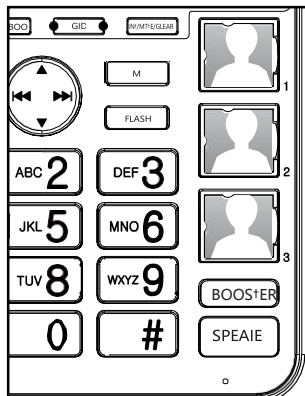
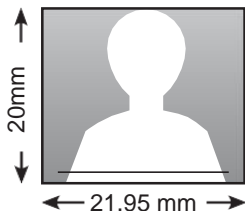

8.3 Registration

Your handset and base station is pre-registered. Up to five handsets can be registered to a single base station.

If for some reason, the handset is not registered to the base station (Y flashes even when the handset is near the base station), register your handset according to the following procedure.

On the photo handset

On the Base: First place the base of the AMPLIDECT295 or AMPLIDECT COMBI 295 in Registration mode.

Replace photo handset back on the charging pod, the red LED flashes quickly to indicate registration in process.

You will hear a confirmation beep when the registration process completes. It takes up to 60 seconds to complete the registration.

Note: if the handset doesn't arrive un registered, please follow this procedure:

Handset: Quickly press [VOL+] [SPK] [VOL-] [SPK] [VOL+] [VOL-] [SPK] in idle mode, then HS will have a "Bi,Bi" tone.

On the standard cordless handset:

1. Press **MENU/OK** (M) and ▲/▼ to select **REGISTRATION**.
2. If you have more than one base, press (M) and ▲/▼ to select the base number from **BASE 1**, **BASE 2**, **BASE 3** and **BASE 4**. There will be a ✕ behind the current registered base number.
3. Press (M) to display "PIN?", enter the 4-digit system PIN for the base (default PIN is 0000).
4. Press (M) and the display will show "WAITING".
5. At the same time, press **MENU/OK** and ▲/▼ on the base to select **REGISTRATION**.
6. Press **MENU/OK** to see "PLEASE WAIT" flashing on the base display. After a short delay, if the registration is successful, there will be a confirmation beep, and the handset display will go back to idle mode with the new handset number shown. The base display will also go back to idle mode.
7. Press **INT/MUTE/CLEAR** at any time to cancel.

8.4 Reset Your Phone

You can reset your phone to the default settings. After reset, all your personal settings and call list entries will be deleted, but your phonebook list remains unchanged.

Using the base:

You can reset all of your base settings to their default settings. After a reset, all your personal base settings, call list entries, redial list entries and answering messages will be deleted.

1. Press **MENU/OK** and **▲/▼** to select **SETTINGS**. Press **MENU/OK** and **▲/▼** to select **BS DEFAULT**.
2. Press **MENU/OK** and you are requested to enter the 4-digit system PIN.
3. Enter the 4-digit system PIN (default PIN is 0000).
4. Press **MENU/OK** to confirm.

9 ANSWERING MACHINE

Your telephone base includes a telephone answering machine that records unanswered calls when it is on. The answering machine can store up to 59 messages within the maximum recording time of approximately 15 minutes. As well as recording incoming messages, you can record memos for other users of your phone.

9.1 Switching Answering Machine On/Off

Using the base direct key:

You can switch on / switch off the TAM function by pressing **ANS ON/OFF**.

Using the base menu:

Alternatively, you can switch the TAM on or off using the base menu.

1. Press **MENU/OK** and **▲/▼** to select **ANS. MACHINE**.
2. Press **MENU/OK** and **▲/▼** to go to **TAM ON/OFF**.
3. Press **MENU/OK** and **▲/▼** to select **ON** or **OFF**.
4. Press **MENU/OK** to confirm.

9.2 Play Messages on TAM

If you have new messages, the display will show e.g. 02/05 MSGS, which means you have 2 new message out of total 5 messages. New messages are played first, and then are saved as old messages, until they are deleted. Old messages are played again after all new messages are played completely.

Using the base direct key:

In idle:

1. Press **PLAY/STOP** to listen to messages and memos.
2. Press **PLAY/STOP** if you want to stop the playback.
3. Press **◀** once if you want to repeat the current message from the beginning, or press twice to skip back to the previous message during message playback.
4. Press **▶** if you want to skip forward to the next message during message playback.
5. Press **DELETE** if you want to delete the current message being played.

Using the base menu:

1. Press **MENU/OK** and **▲/▼** to select **ANS. MACHINE**.
2. Press **MENU/OK** to show **MSG PLAYBACK**.
3. Press **MENU/OK** to start playing back the messages from speakerphone.

9.3 Delete all Messages on TAM

Using the base menu:

1. Press **MENU/OK** and **▲/▼** to select **ANS. MACHINE**.
2. Press **MENU/OK** and **▲/▼** to select **DELETE ALL**.
3. Press **MENU/OK**.
4. Press **MENU/OK** again to confirm delete all old messages.

Using the base direct key:

Press and hold **DELETE** to delete all the old messages.

NOTE:

You cannot delete new messages, so you will have to play them before trying to delete.

9.4 Record Memos on TAM

You can record your memo message for another user. When you record a memo, the message counter will increase by one and the message can be played in the same way as answering machine messages. Memo recording can still function even when the answering machine is turned off.

Using the base:

1. Press **MENU/OK** and ▲/▼ to select **ANS. MACHINE**.
2. Press **MENU/OK** and ▲/▼ to select **MEMO**.
3. Press **MENU/OK** to start recording the memo, and "RECORDING" is shown on the display.
4. Press **MENU/OK** to save and end your memo recording. The new memo will then play back automatically. Let it play to the end or press **MENU/OK** again to stop the playback. Or press **INT/MUTE/CLEAR** at any time to stop the memo without saving it.

9.5 Answering Machine Settings

9.5.1 Set the Answer Mode

By default, the answer machine is set in ANS&REC mode which allows callers to leave a message. This mode can be changed to ANSONLY which does not allow callers to leave a message. In that case, your callers will be prompted to call back later.

You can select ANS & REC or ANSWER ONLY for the answering machine.

Using the base:

1. Press **MENU/OK** and **▲/▼** to select **ANS. MACHINE**.
2. Press **MENU/OK** and **▲/▼** to select **TAM SETTINGS**.
3. Press **MENU/OK** to show **ANSWER MODE**.
4. Press **MENU/OK** and **▲/▼** to select **ANS & REC** or **ANSWER ONLY**.
5. Press **MENU/OK** to confirm.

9.5.2 Set the TAM Language

You can choose the voice prompt language of the answering machine from a total of 3 languages French, English and German.

Using the base:

1. Press **MENU/OK** and **▲/▼** to select **ANS. MACHINE**.
2. Press **MENU/OK** and **▲/▼** to select **TAM SETTINGS**.
3. Press **MENU/OK** and **▲/▼** to select **TAM LANGUAGE**.
4. Press **MENU/OK** and **▲/▼** to select the desired voice prompt language for the answering machine.
5. Press **MENU/OK** to confirm

9.5.3 Record your Outgoing Message (OGM)

You can record your own OGM for ANS & REC mode or ANSWER ONLY mode. When you record your own OGM, it will be used when the answering machine answers the call. If your personalized OGM is deleted, the pre-set OGM will be restored automatically.

Using the base:

1. Press **MENU/OK** and **▲▼** to select **ANS. MACHINE**.
2. Press **MENU/OK** and **▲▼** to select **TAM SETTINGS**.
3. Press **MENU/OK** and **▲▼** to select **OGM SETTINGS**.
4. Press **MENU/OK** and **▲▼** to select **ANS & REC** or **ANSWER ONLY**.
5. Press **MENU/OK** and **▲▼** to select **RECORD**.
6. Press **MENU/OK** to start recording your personalized OGM and "RECORDING" is displayed on the screen.
7. Press **MENU/OK** to stop and save your personalized OGM. Your new saved OGM will playback automatically. Alternatively, press **INT/MUTE/CLEAR** to return to previous screen without saving the personalized OGM.

9.5.4 Playback the Outgoing Message (OGM)

Using the base direct key:

Press **◀** briefly to listen to the current OGM (ANS & REC or ANSWER ONLY).

Using the base menu:

1. Press **MENU/OK** and **▲▼** to select **ANS. MACHINE**.
2. Press **MENU/OK** and **▲▼** to select **TAM SETTINGS**.
3. Press **MENU/OK** and **▲▼** to select **OGM SETTING**.
4. Press **MENU/OK** and **▲▼** to select **ANS & REC** or **ANSWER ONLY**.
5. Press **MENU/OK** and **▲▼** to select **PLAYBACK**.
6. Press **MENU/OK** to playback your personalized OGM (if you have recorded a personalized OGM before) and "PLAYING OGM" is displayed on the screen.
7. Press **MENU/OK** to stop the OGM playback and return to the previous menu.

NOTE:

If a personalized OGM is not recorded before, the pre-set OGM will be played.

9.5.5 Delete a Personalized OGM (SET OGM to DEFAULT)

Using the base:

1. Press **MENU/OK** and ▲/▼ to select **ANS. MACHINE**.
2. Press **MENU/OK** and ▲/▼ to select **TAM SETTINGS**.
3. Press **MENU/OK** and ▲/▼ to select **OGM SETTING**.
4. Press **MENU/OK** and ▲/▼ to select **ANS & REC** or **ANSWER ONLY**.
5. Press **MENU/OK** and ▲/▼ to select **DEFAULT**.
6. Press **MENU/OK** and enter the 4-digit system PIN (default PIN is 0000).
7. Press **MENU/OK** to confirm.

9.5.6 Set the Answer Delay

You can set the number of rings before the answering machine answers and starts playing your OGM. You can set the answering machine to answer after two to eight rings or TIME SAVER.

The TIME SAVER function answers calls after 6 ring signals, until the first new message has been registered - then the answering machine switches to answering after approximately 2 signals. This is useful when using remote access; if you call up the answering machine and there is no reply after four rings that means there are no messages recorded and you can hang up before you are charged for the call.

Using the base:

1. Press **MENU/OK** and ▲/▼ to select **ANS. MACHINE**.
2. Press **MENU/OK** and ▲/▼ to select **TAM SETTINGS**.
3. Press **MENU/OK** and ▲/▼ to select **ANSWER DELAY**.
4. Scroll **MENU/OK** and ▲/▼ to select the desired answer delay.
5. Press **MENU/OK** to confirm

9.5.7 Set the Recording Time of Incoming Message

You can set the maximum length of the recording time of the incoming messages.

Using the base:

1. Press **MENU/OK** and ▲ ▼ to select **ANS. MACHINE**.
2. Press **MENU/OK** and ▲ ▼ to select **TAM SETTINGS**.
3. Press **MENU/OK** and ▲ ▼ to select **RECORD TIME**.
4. Press **MENU/OK** and ▲ ▼ to select your desired recording time.
5. Press **MENU/OK** to confirm

9.5.8 Turn On or Off the Base Screening

You can select to turn on or off the call screening on base. When the answering machine is set to ON and when there is an incoming message, the base will start call screening automatically after the preset numbers of rings of answer delay.

Using the base:

1. Press **MENU/OK** and **▲▼** to select **ANS. MACHINE**.
2. Press **MENU/OK** and **▲▼** to select **TAM SETTINGS**.
3. Press **MENU/OK** and **▲▼** to select **BS SCREENING**.
4. Press **MENU/OK** and **▲▼** to select **ON** or **OFF**.
5. Press **MENU/OK** to confirm.

9.5.9 Change the Compression Rate

Three different compression rates (HIGH, MID and LOW) are provided for you to select different quality levels of recording incoming message. The lower the compression rate, the higher the recording quality level attained, but the shorter the total recording time available.

Using the base:

1. Press **MENU/OK** and **▲▼** to select **ANS. MACHINE**.
2. Press **MENU/OK** and **▲▼** to select **TAM SETTINGS**.
1. Press **MENU/OK** and **▲▼** to select **COMPRESSION** (Available options: **HIGH**, **MEDIUM**, or **LOW**).
3. Press **MENU/OK** and **▲▼** to select your desired compression rate.
4. Press **MENU/OK** to confirm.

9.5.10 Activate Remote Access

Your phone lets you check your messages, or otherwise operate your answering machine, by calling the answering machine when you are away from home by entering a 4-digit remote access PIN on a tone-dialing phone. Use the 4-digit remote access PIN code to prevent other people from unauthorized access of your answering machine.

9.5.10.1 Change the 4-Digit Remote Access PIN

Using the base:

1. Press **MENU/OK** and ▲▼ to select **ANS. MACHINE**.
2. Press **MENU/OK** and ▲▼ to select **TAM SETTINGS**.
3. Press **MENU/OK** and ▲▼ to select **CHANGE PIN**.
4. Press **MENU/OK** and enter the old PIN (default remote access PIN is 0000).
5. Press **MENU/OK** and enter your new 4-digit PIN.
6. Press **MENU/OK** and enter your new 4-digit PIN again.
7. Press **MENU/OK** to confirm.

9.5.10.2 Activate or Deactivate the Remote access

Using the base:

1. Press **MENU/OK** and ▲▼ to select **ANS. MACHINE**.
2. Press **MENU/OK** and ▲▼ to select **TAM SETTINGS**.
3. Press **MENU/OK** and ▲▼ to select **REMOTE ACC**.
4. Press **MENU/OK** and ▲▼ to select **ON** or **OFF** to turn on or off the remote access respectively.
5. Press **MENU/OK** to confirm.

9.5.10.3 Reset TAM to Default Settings

Using the base:

1. Press **MENU/OK** and ▲▼ to select **ANS. MACHINE**.
2. Press **MENU/OK** and ▲▼ to select **TAM SETTINGS**.
3. Press **MENU/OK** and ▲▼ to select **TAM DEFAULT**.
4. Press **MENU/OK** and then enter the correct system PIN (default PIN is 0000).
5. Press **MENU/OK** to restore the TAM settings to default.

9.5.10.4 Remote Operations

If you are away from your home, you can call your answering machine to switch on or off the answering machine and listen to your messages remotely using another tone-dialing phone.

1. Place a call from a tone-dialing phone.
2. When the answering machine answers the call and starts playing OGM, press ✕.
3. Enter the 4-digit Remote Access PIN (default PIN is 0000).
4. Press the following keys to carry out your desired function.

Keys	Functions	
	While message is not playing	While message is playing
2		Delete the current message playback
4		Repeat playing the current message from the beginning. Press twice to skip backward to the previous message.
5	Play the message	
6		Skip forward to play the next message
7	Turn on the answering machine	
8		Stop the current message playback
9	Turn off the answering machine	
*	Enter the 4-digit remote access PIN	

NOTE:

- When your answering machine memory is full and the answer mode is in ANS & RECORD, the answer mode will change to ANSWER ONLY automatically. It will change to ANS & RECORD mode automatically after some messages have been deleted.

10. TROUBLESHOOTING

If you have difficulty with your phone, please try the suggestions listed below.

Problem	Solutions
My telephone does not work at all.	<ul style="list-style-type: none">• Make sure the battery is installed and charged correctly.• For optimum daily performance, return the handset to the telephone base after use.• Make sure the power adapter is securely plugged into an outlet not controlled by a wall switch.• Make sure the telephone line cord is plugged firmly into the telephone base and the telephone wall jack.• Unplug the electrical power to the telephone base. Wait for approximately 15 seconds, then plug it back in. Allow up to one minute for the handset and telephone base to synchronize.• Remove and re-insert the battery. If that still does not work, it might be necessary to purchase a new battery.• Disconnect the telephone base from the telephone wall jack and plug in a working telephone. If the other telephone does not work, the problem is probably in the wiring or the telephone service. Call your telephone service provider.
Low battery shows on screen.	<ul style="list-style-type: none">• Place the handset in the telephone base for recharging.• Remove and re-install the battery and use it until fully depleted, then recharge the handset in the telephone base.• If the above measures do not solve the problem, replace the battery.
The battery do not charge in the handset or the handset battery do not accept charge.	<ul style="list-style-type: none">• Make sure the handset is placed in the telephone base correctly.• Remove and reinstall the battery, then charge for up to 16 hours.• Purchase a new battery.

There is interference during a telephone conversation. My calls fade out when I am using the handset.

- The handset may be out of range. Move it closer to the telephone base.
- If you subscribe to high-speed Internet service (digital subscriber line - DSL) through your telephone line, you must install a DSL filter between the telephone base and the telephone wall jack. The filter prevents noise and caller ID problems caused by DSL interference. Please contact your DSL service provider for more information about DSL filters.
- Appliances or other cordless telephones plugged into the same circuit as the telephone base can cause interference
- Try moving the appliance or telephone base to another outlet.
- Other electronic products may cause interference to your cordless telephone. Install your telephone as far away as possible from the following electronic devices: wireless routers, radios, radio towers, pager towers, cellular telephones, digital telephones, intercoms, room monitors, televisions, VCRs, personal computers, kitchen appliances, and other cordless telephones.
- If your telephone is plugged in with a modem or a surge protector, plug the telephone (or modem/surge protector) into a different location. If this doesn't solve the problem, re-locate your telephone or modem farther apart from each other, or use a different surge protector.
- The location of your telephone base can impact the performance of your cordless phone. For better reception, install the telephone base in a centralized location within your home or office, away from walls or other obstructions. In many environments, elevating the telephone base improves overall performance.
- Disconnect the telephone base from the telephone wall jack and plug in a corded telephone. If calls are still not clear, the problem is probably in the wiring or telephone service.
- Contact your telephone service provider (charges might apply).
- If the other telephones in your home are having the same problem, the problem is in the wiring or telephone service.
- Contact your telephone service provider (charges may apply).

Common cure for electronic equipment.	<p>If the telephone is not responding normally, put the handset in the telephone base. If it does not respond, try the following (in the order listed):</p> <ul style="list-style-type: none">• Disconnect the power to the telephone base.• Disconnect the battery on the handset.• Wait a few minutes before connecting power to the telephone base.• Re-install the battery and place the handset in the telephone base.• Wait for the handset to synchronize with the telephone base.
--	---

This telephone is not equipped with a grounding function! Therefore some of the functions may be limited when used in PBX systems.

Please contact the technical support of the network provider for further information.

11. TECHNICAL SPECIFICATIONS

Basic Information	
Handset Valid range	Indoor: 50m * Outdoor: 300m *
Handset Operating Time	Standby time: 100Hours approx. ** Talk time: 10Hours approx. **
RF Parameter	
Frequency	1.88GHz to 1.9GHz
Number of Channels	10
RF Power	<250mW
Power Supply	
Base	Input 100-240V 50/60Hz; output 6V; 450mA adapter
Handset Charger	Input 100-240V 50/60Hz; output 6V; 450mA adapter
Handset	2.4V; 500mAH rechargeable battery pack

* Values may vary according to environment.

** Depending on initial battery charge.

12. CARE AND MAINTENANCE INSTRUCTIONS

Take care of your telephone

- Your cordless telephone contains sophisticated electronic parts, so you must treat it with care.
- Avoid rough treatment.
- Place the handset down gently.
- Save the original packing materials to protect your telephone if you ever need to ship it.

Avoid water

- You can damage your telephone if it gets wet. Do not use the handset in the rain, or handle it with wet hands. Do not install the telephone base near a sink, bathtub or shower.

Electrical storms

- Electrical storms can sometimes cause power surges harmful to electronic equipment. For your own safety, take caution when using electric appliances during storms.

Cleaning your telephone

- Your telephone has a durable plastic casing that should retain its luster for many years. Clean it only with a soft cloth slightly dampened with water or a mild soap.
- Do not use excess water or cleaning solvents of any kind.

NOTE

Remember that electrical appliances can cause serious injury if used when you are wet or standing in water. If the telephone base should fall into water, **DO NOT RETRIEVE IT UNTIL YOU UNPLUG THE POWER CORD AND TELEPHONE LINE CORDS FROM THE WALL.** Then pull the unit out by the unplugged cords.

CAUTION

**RISK OF EXPLOSION IF BATTERY IS REPLACED
BY AN INCORRECT TYPE.
DISPOSE OF USED BATTERY ACCORDING
TO THE INSTRUCTIONS.**

13. GUARANTEE

From the moment your Geemarc product is purchased, Geemarc guarantee it for the period of two years. During this time, all repairs or replacements (at our discretion) are free of charge. Should you experience a problem then contact our help line or visit our website at www.geemarc.com.

The guarantee does not cover accidents, negligence or breakages to any parts. The product must not be tampered with or taken apart by anyone who is not an authorized Geemarc representative.

The Geemarc guarantee in no way limits your legal rights.

IMPORTANT: YOUR RECEIPT IS PART OF YOUR GUARANTEE AND MUST BE RETAINED AND PRODUCED IN THE EVENT OF A WARRANTY CLAIM.

Please note: The guarantee applies to the United Kingdom only.

14. DECLARATIONS:

CE Directives

Geemarc Telecom SA hereby declares that this product is in compliance with the essential requirements and other relevant provisions of the Radio Equipment Directive 2014/53/UE.

The CE declaration of conformity may be consulted at www.geemarc.com

Recycling Directives

The WEEE (Waste Electrical and Electronic Equipment) has been put in place for the products at the end of their useful life are recycled in the best way.

When this product is finished with, please do not put it in your domestic waste bin. Please use one of the following disposal options:

- Remove the batteries and deposit them in an appropriate WEEE skip.

Deposit the product in an appropriate WEEE skip.

- Or, hand the old product to the retailer. If you purchase a new one, they should accept it.

Thus if you respect these instructions you ensure human health and environmental protection.



For product support and help visit our website at

www.geemarc.com

E-mail : help@geemarc.com telephone 01707 387602

lines are open 09h00 to 16h00 Mon to Fri

This product is made in China To Geemarc Telecom



UG COMBI DECT295Photo_En_v0.2

Telecom FRANCE
2 rue Galilée-
Parc de l'étoile
59791 GRANDE-SYNTHE Cedex
France

E-mail : help@geemarc.com telephone 01707 387602
lines are open 09h00 to 16h00 Mon to Fri