

APE BEST FOR YOU 2022

LIBRO DE COLECCIONES
BOOK OF COLLECTIONS
LIVRE DE COLLECTIONS

 30 years
moulding
the future
apegrupo

Cement

14

Cotto

52

Metal

62

Wood

68

Marble

86

Stone

160

Textile

188

Chromatic

202

Nuestros productos son el resultado de nuestra cultura, mentalidad y filosofía corporativa basada prioritariamente en la innovación, la calidad y en nuestra preocupación por un entorno sostenible. En Ape Cerámica apostamos por la ecología porque sabemos que ser una empresa de futuro pasa por ser una empresa responsable con el cuidado del planeta. Tanto es así, que contamos con los medios técnicos, humanos y económicos a nuestro alcance para prevenir el impacto ambiental que pueda generar nuestra actividad y para garantizar la seguridad de nuestros trabajadores y de nuestro entorno social.

Our products are the result of our culture, mentality and corporate philosophy. They are primarily based on innovation, quality and our concern for a sustainable environment. At Ape Ceramica we are committed to ecology because we know that we must take care of our planet if we want to be a company of the future. So much so that we have the technical, human and economic means at our disposal to prevent the environmental impact that can be generated by our activity and to grant the security of our staff and our social environment.

30 años moldeando el futuro

30 years moulding the future

Abrimos un nuevo capítulo en nuestra historia: este 2022 se vuelve especial gracias a nuestro 30 aniversario. Llegamos a ese momento como la compañía líder en la creación de espacios diferenciados, donde el diseño de nuestros productos y el servicio personalizado son la clave de nuestro crecimiento.

Una meta tan importante como difícil de alcanzar en los tiempos que corren, pero que no hubiera sido posible sin nuestros equipos, clientes, proveedores y colaboradores. Una satisfacción compartida con todas las partes que hacen posible la mezcla perfecta.

Llegados a este punto, ponemos la mirada en el mañana, en seguir descubriendo tendencias emergentes y escuchar a un mundo en constante evolución. Nuestro propósito es conocer, aprender y sumar. Ser capaces de abordar cualquier desafío con perspectiva y conocimiento para aportar una solución de valor.

Es un año de futuro, de mirar hacia delante, de abrazar nuevas corrientes y de transformación digital. Nos reconvertimos para seguir por el buen camino, trabajando en estrategias de futuro, implementando nuevas herramientas y tecnología para estar cada vez más cerca de nuestros públicos, de nuestro entorno y del sector.

We open a new chapter in our history: this 2022 becomes special thanks to our 30th anniversary.

We arrived at that moment as the leading company in the creation of differentiated spaces, where the design of our products and personalized service are the key to our growth.

A goal as important as it is difficult to achieve in these times, but which wouldn't have been possible without our teams, clients, suppliers and collaborators. A shared satisfaction with all the parties that make the perfect mix possible.

At this point, we have an eye on tomorrow to continue discovering emerging trends and listening to a world in constant evolution. Our purpose is to know, learn and add. Being able to tackle any challenge with perspective and knowledge to provide a valuable solution.

It is a year of future, of looking forward, of embracing new currents and of digital transformation. We reconvert ourselves to continue on the right path, working on strategies for the future, implementing new tools and technology to be ever closer to our audiences, our environment and the sector.

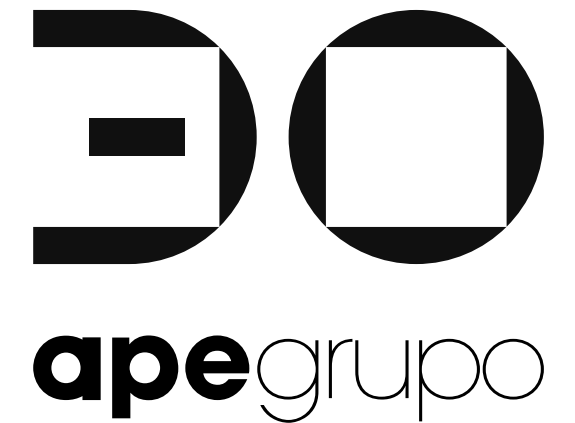

Índice

orden por inspiración

Cement

CHIC	44
FLOW	42
ILLINOIS	28
KLEN	50
LEEDS	36
NAXOS	32
OLD STREET	38
PLUS	34
SHARON	46
TIMELESS	47
TWIST	40
WABI SABI	17
WORK	24

Metal

DORIAN	66
OSSIDI	67
STEEL	64

Cotto

ARGILLAE	54
----------	----

Chromatic

ALL WHITE	232
ALLEGRA	230
ARTS	236
ATELIER	204
BELVEDERE	248
BLISS	238
CHROME	208
CLOUD	228
COLORS	251
CRYSTAL	216
EPOCA	217
FOUR SEASONS	212
FUNNY	242
HOME	244
LOFT	250
LORD	246
MATERIA	210
METRO	250
MONTBLANC	216
ORSAY	234
PIEMONTE	249
SILK	224
STAY	240
STUDIO	217
THIS IS	245
TONALITY	218

Marble

ALPEN QUARTZ	88
ALPI GREEN	92
AMARULA	90
AMAZONITE	108
AMBOISE LUX	94
BLUE EXPLOSION	109
CALACATTA BORGHINI	96
CALACATTA GOLD/SILVER	98
CALACATTA SLOW	100
CAPRAIA	134
CERVINO	102
DEDALUS	110
ELEGANZA	149
EMERALD ONIX	111
ETERNAL GOLD	112
FIOR DI PESCO	113
GAYA QUARTZITE	146
GIO	152
GOLDEN BLACK	136
GREEK CAPUCCINO	138
JADORE	114
JORDAN	154
LUNA BLANCA	106
MANDALAY	130
MARE DI SABBIA	132
MOONLIGHT	150
NERO MARQUINA	135
NIGHT LUX	140
ONICE	142
ONYX SLOW	144
OXYD JEWEL	147
PERSIAN ONIX	148
REX	118
REX 25X75	155
SAINT LAURENT	116
SILVER GREY	120

Index

inspiration order

Marble

SILVER PEARL	156
STATUARY	157
STATUARY VENATO	122
TAJ MAHAL	115
TRAVERTINO	158
VAN GOGH	117
VITA	124
WABI SABI	126

Stone

4.STONES	162
BURLINGTON	174
CROSS	170
DEEP BLUE	182
LIMESTONE	186
LUGANO	185
NULVI	184
OXFORD	178
PIERRE DE BALI	180
TERRAZZO	172

Textile

BALI	192
CLICK	194
CRAYON	198
FABLES	200
HABITAT	190
RE-USE	196

Wood

ALABAMA	72
APALACHE	74
GIZA	85
HAVANA	84
KOEN	70
LUXOR	85
OREGON	78
PROJECT / TIME	77
QUEBEC	76
TRIANA	80
WABI SABI	82
WORK	75

Índice

alfabético de producto





4

4.STONES 162 









A





ALABAMA 72 
ALL WHITE 232 
ALLEGRA 230 
ALPEN QUARTZ 88 
ALPI GREEN 92 
AMARULA 90 
AMAZONITE 108 
AMBOISE LUX 94 
APALACHE 74 
ARGILLAE 54 
ARTS 236 
ATELIER 204 

B

BALI 192 
BELVEDERE 248 
BLISS 238 
BLUE EXPLOSION 109 
BURLINGTON 174 

C

CALACATTA BORGHINI 96 
CALACATTA GOLD/SILVER 98 
CALACATTA SLOW 100 
CAPRAIA 134 
CERVINO 102 
CHIC 44 
CHROME 208 
CLICK 194 

CLOUD 228 
COLORS 251 
CRAYON 198 
CROSS 170 
CRYSTAL 216 

D

DEDALUS 110 
DEEP BLUE 182 
DORIAN 66 





E

ELEGANZA 149 
EMERALD ONIX 111 
EPOCA 217 
ETERNAL GOLD 112 

F

FABLES 200 
FIOR DI PESCO 113 
FLOW 42 
FOUR SEASONS 212 
FUNNY 242 

G

GAYA QUARTZITE 146 
GIO 152 
GIZA 85 
GOLDEN BLACK 136 
GREEK CAPUCCINO 138 

H

HABITAT 190 
HAVANA 84 
HOME 244 

I

ILLINOIS 28 

J

JADORE 114 
JORDAN 154 

K

KLEN 50 
KOEN 70 

L

LEEDS 36 
LIMESTONE 186 
LOFT 250 
LORD 246 
LUGANO 185 
LUNA BLANCA 104 
LUXOR 85 







M

MANDALAY 130 
MARE DI SABBIA 132 
MATERIA 210 
METRO 250 
MONTBLANC 216 
MOONLIGHT 150 





N

NAXOS 32 
NERO MARQUINA 135 
NIGHT LUX 140 
NULVI 184 

O

OLD STREET 38 
ONICE 142 
ONYX SLOW 144 
OREGON 78 
ORSAY 234 
OSSIDI 67 
OXFORD 178 
OXYD JEWEL 147 



P

PERSIAN ONIX 148 
PIEMONTE 249 
PIERRE DE BALI 180 
PLUS 34 
PROJECT / TIME 77 

Q

QUEBEC 76 

R

RE-USE 196 
REX 118 
REX 25X75 155 

S

SAINT LAURENT 116 
SHARON 46 
SILK 224 
SILVER GREY 120 
SILVER PEARL 156 
STATUARY 157 
STATUARY VENATO 122 
STAY 240 
STEEL 64 
STUDIO 217 

T

TAJ MAHAL 115 
TERRAZZO 172 
THIS IS 245 
TIMELESS 47 
TONALITY 218 
TRAVERTINO 158 
TRIANA 80 
TWIST 40 

V

VAN GOGH 117 
VITA 124 

W

WABI SABI - Cemento 17 
WABI SABI - Madera 82 
WABI SABI - Marmol 126 
WORK - Cemento 24 
WORK - Madera 75 

Índice

por formatos

120X260

ALPEN QUARTZ	88
ALPI GREEN	92
CALACATTA SLOW	100
CHROME	208
LUNA BLANCA	104
NERO MARQUINA	135
VITA	125
WABI SABI	17

120X120

AMAZONITE	108
AMBOISE LUX	94
ARGILLAE	54
CALACATTA BORGHINI	96
CALACATTA GOLD/SILVER	98
CALACATTA SLOW	100
CERVINO	102
DEDALUS	110
ETERNAL GOLD	112
LUNA BLANCA	104
ONYX SLOW	144
REX	118
SILVER GREY	120
STATUARY VENATO	122
TAJ MAHAL	115
VITA	124
WABI SABI	18
WORK	24

100X100

ILLINOIS	28
----------	----

90X90

4.STONES	164
ALPEN QUARTZ	88
CALACATTA SLOW	100
TERRAZZO	172
WORK	24

80X80

AMBOISE LUX	94
CAPRAIA	134
CERVINO	102
KOEN	70

MANDALAY	130
MARE DI SABBIA	132
MATERIA	210

75X75

BURLINGTON	174
CRYSTAL	216
ELEGANZA	149
GIO	152
ILLINOIS	28
MOONLIGHT	150
WABI SABI	82

60X120

4.STONES	162
ALPEN QUARTZ	88
AMARULA	90
AMAZONITE	108
AMBOISE LUX	94
ARGILLAE	54
BLUE EXPLOSION	109
BURLINGTON	174
CALACATTA BORGHINI	96
CALACATTA GOLD/SILVER	98
CALACATTA SLOW	100
CAPRAIA	134
CERVINO	102
CROSS	170
DEDALUS	110
DORIAN	66
ELEGANZA	149
EMERALD ONIX	111
ETERNAL GOLD	112
FIOR DI PESCO	113
FOUR SEASONS	212
GAYA QUARTZITE	146
GIO	152
GOLDEN BLACK	136
GREEK CAPUCCINO	138
ILLINOIS	30
JADORE	114
LUNA BLANCA	104
MANDALAY	130
MARE DI SABBIA	132
MONTBLANC	216
NAXOS	32
NIGHT LUX	140

ONICE	142
ONYX SLOW	144
OXYD JEWEL	147
PERSIAN ONIX	148
PLUS	34
REX	118
SAINT LAURENT	116
SILVER GREY	120
STATUARY VENATO	122
STEEL	64
TAJ MAHAL	115
TONALITY	218
VAN GOGH	117
VITA	124
WABI SABI	18
WORK	25

60X60

ARGILLAE	54
BURLINGTON	174
CALACATTA BORGHINI	96
CALACATTA SLOW	100
CERVINO	102
CROSS	170
DORIAN	66
EPOCA	217
FOUR SEASONS	215
ILLINOIS	30
KLEN	51
LIMESTONE	186
LUNA BLANCA	104
MANDALAY	130
MARE DI SABBIA	132
MATERIA	210
NIGHT LUX	140
ONYX SLOW	144
REX 25X75	155
SILVER PEARL	156
STATUARY	157
STATUARY VENATO	122
VITA	124
WABI SABI	18
WORK	25

59X119

ALPI GREEN	92
NERO MARQUINA	135

59X59

ALPI GREEN	92
------------	----

14,5X14,5

ALPI GREEN	92
------------	----

45X45

JORDAN	154
NULVI	184

40X120

4.STONES	162
CALACATTA SLOW	101
CLICK	194
KOEN	70
LEEDS	36
LUNA BLANCA	106
OLD STREET	38
ONYX SLOW	145
RE-USE	196
SILK	224
TWIST	40

35X100

CLOUD	228
STUDIO	217

33,3X100

FLOW	42
------	----

33X66,5

OXFORD	178
--------	-----

32X36,9

BALI	192
------	-----

31,6X90

ALLEGRA	230
CHIC	44
CRAYON	198
GIO	152

30X120

4.STONES	162
KOEN	70
WORK	75

30X90

ALL WHITE	232
BURLINGTON	176
FABLES	200
OREGON	78
SHARON	46
TIMELESS	47

30X60

ALL WHITE	232
ARGILLAE	54
BALI	192
BURLINGTON	174
CALACATTA BORGHINI	96
CERVINO	102
CROSS	170
DEEP BLUE	182
DORIAN	66
HABITAT	190
MANDALAY	130
PIERRE DE BALI	180
TRIANA	80
VITA	124
WABI SABI	18
WORK	25

30X30

ARGILLAE	54
----------	----

29,5X29,5

ALPI GREEN	92
------------	----

28X59

ALPI GREEN	92
------------	----

Index

format order

25X75

KLEN	50
LIMESTONE	186
REX 25X75	155
SILVER PEARL	156
STATUARY	157
TRAVERTINO	158

25X50

JORDAN	154
NULVI	184

25X29

ALABAMA	72
---------	----

23X26

KLEN	51
OLD STREET	38
STAY	240
TERRAZZO	172

22,5X90

GIZA	85
HAVANA	84
LUXOR	85

21X18,2

WORK	24
------	----

20X120

4.STONES	162
ALABAMA	72
APALACHE	74
KOEN	70
OREGON	78
PROJECT / TIME	77
QUEBEC	76
TONALITY	219
TRIANA	80

WABI SABI	82
WORK	75

20X60

APALACHE	74
BLISS	238
FUNNY	242
HOME	244
LUGANO	185
ORSAY	234
OSSIDI	67
STAY	240

20X50

ARTS	236
THIS IS	245

20X20

ARTS	236
COLORS	251
LORD	246
STAY	240

17,5X20,2

HOME	244
------	-----

15X15

CROSS	170
DEEP BLUE	182
PIERRE DE BALI	180
TONALITY	219

13,9X16

CALACATTA SLOW	101
ONYX SLOW	145
TONALITY	218

10X30

BELVEDERE	248
LOFT	250

10X20

METRO	250
-------	-----

9,8X46,5

OREGON	78
--------	----

7,5X15

METRO	250
PIEMONTE	249

7X28

ARGILLAE	54
----------	----

7,5X30

CALACATTA SLOW	101
ONYX SLOW	145

simbología

symbols

- P** PORCELÁNICO/PORCELAIN TILES/GRÉS CERÁME
- PR** PASTA ROJA/RED BODY/PÂTE ROUGE
- PB** PASTA BLANCA/WHITE BODY/PÂTE BLANCHE
- RE** REVESTIMIENTO/WALL TILE/FAÏENCE
- FT** PAVIMENTO/FLOOR TILES/SOL
- B** BRILLO/SHINE/BRILLANT
- M** MATE/MATT/MAT
- S** SATINADO/SATIN/SATIN
- SP** PULIDO BRILLO/SHINE POLISHED/POLI BRILLANT
- MP** PULIDO MATE/MATT POLISHED/POLI MAT
- L** LAPATTO/LAPPED/LAPATTO
- LM** LAPATTO MATE/MATT LAPPED/LAPATTO MAT
- G** GRANILLA PULIDA/GRAIN POLISHED/GRAIN POLI
- E** ESMALTE PULIDO/GLAZE POLISHED SHINY ÉMAIL POLI BRILLANT
- R** RECTIFICADO/RECTIFIED/RECTIFIÉ
- MAS** MASA COLOREADA/COLORÉD BODY/TEINTÉE DANS LA MASSE
- ES** ESPESORADO/THICKNESS/ÉPAISSEUR
- EN** ENMALLADO/MESHED/MAILLÉ
- PN** PRODUCTO NATURAL/NATURAL PRODUCT/PRODUIT NATUREL
- U** ULTRAFINO/SLIM/ULTRA-MINCE
- HM** HECHO A MANO/HAND MADE/FAIT MAIN
- AF** ANTIHIELO/FROST PROOF/RÉSISTANT AU GEL
- J** JUNTA RECOMENDADA 5MM/RECOMMENDED JOINT 0,2"/JOINTE ENTRE CHAQUE PIÈCE À 5MMLA MISE.
- ES10** ESPESOR 10MM/THICKNESS 0,4"/ÉPAISSEUR 10MM
- N** EXTRUSIONADO/EXTRUDED/EXTRUDÉ
- C0** CLASE 0/CLASS 0/CLASSE 0
- C1** CLASE 1/CLASS 1/CLASSE 1
- C2** CLASE 2/CLASS 2/CLASSE 2
- C3** CLASE 3/CLASS 3/CLASSE 3
- R9** ANTI-SLIP R9
- R10** ANTI-SLIP R10
- R11** ANTI-SLIP R11
- R12** ANTI-SLIP R12
- ANTISLIP** (DIN 51097)
- (DCOF) >0.50**
- V1** ASPECTO UNIFORME/UNIFORM APPEARANCE/APPEARANCE UNIFORME
- V2** VARIACION LEVE/SLIGHT VARIATION/LÉGERÉ VARIATION
- V3** VARIACION MODERADA/MODERATE VARIATION/MODÉRÉE VARIATION
- V4** VARIACION FUERTE/SUBSTANTIAL VARIATION/FORTE VARIATION
- M** MODULARIDAD/MODULARITY/MODULARITÉ
- V** VARIACIÓN DE DISEÑO XX PIEZAS/GRAPHIC FACES XX PIECES/TAMPONS DIFFÉRENTS XX PIÈCES
- RU1** BAÑOS Y DORMITORIOS DE VIVIENDAS. BATHROOMS AND BEDROOMS. SALLES DE BAINS ET CHAMBRES D'HABITATIONS.
- RU2** TODA LA VIVIENDA EXCEPTO COCINAS Y VESTÍBULOS. ALL THE HOUSE EXCEPT KITCHENS AND HALLWAYS. TOUTE L'HABITATION, SAUF CUISINES ET VESTIBULES.
- RU3** CUALQUIER HABITACION DE VIVIENDA CON ACCESO PROTEGIDO POR FELPUDO SI DA AL EXTERIOR. ANY ROOM IN THE HOUSE WITH ACCESS PROTECTED BY A DOORMAT IF IT FACES OUTDOORS. TOUTE PIÈCE DE L'HABITATION DONT L'ACCÈS EST PROTÉGÉ PAR UN PAILLASSON SI ELLE DONNE SUR L'EXTÉRIEUR.
- RU4** TODA LA VIVIENDA Y LOCALES COMERCIALES DE TRANSITO LIMITADO. ALL THE HOUSE AND COMMERCIAL PREMISES WITH LIMITED TRAFFIC. TOUTE L'HABITATION ET LES LOCAUX COMMERCIAUX À TRAFIC MODÉRÉ.
- RU5** CUALQUIER ESTANCIA SOMETIDA A UN TRANSITO RELATIVAMENTE FUERTE Y NO PROTEGIDO. ANY ROOM SUBJECT TO RELATIVELY HEAVY, UNPROTECTED TRAFFIC. TOUT ESPACE SOUMIS À UN TRAFIC RELATIVEMENT INTENSE ET NON PROTÉGÉ.

simbología interactiva

interactive symbols

- REPRODUCIR VIDEO/PLAY VIDEO
- IR A COLECCIÓN/GO TO COLLECTION
- RED HOUSE
- COLECCIÓN WEB/WEB COLLECTION
- COLECCIÓN RED HOUSE/RED HOUSE COLLECTION
- APEGRUPO WEB

Significado de los símbolos y clasificaciones utilizados en el catálogo.

The meaning of the symbols and classifications used in this catalogue

lectura del catálogo

reading the catalogue

- 01** Nombre de la colección/Collection name
- 02** Formatos de la colección/Collection sizes
- 03** Descripción gráfica de la pieza/Graphic description
- 04** Características de la pieza/Piece characteristics
- 05** Nombre, formato y código de la pieza/Name, size and code of the piece
- 06** Piezas especiales disponibles/Special pieces available
- 07** Características generales de la colección/General Characteristics of the collection
- 08** Características de embalaje de la colección/Packing collection characteristics
- 09** Ambiente de la colección/Collection image
- 10** Descripción del ambiente/Image description
- 11** Marca comercial/Commercial brand
- 12** Nombre y tipología de la colección/Name and typology of the collection
- 13** Número de página/Page number
- 14** Variación de diseño/Graphic faces

Vita 120X120 - 60X120 - 60X60 - 30X60 - 90X180 / 48"X48" - 24"X48" - 24"X24" - 12"X24" - 36"X72"

APE 11 Vita / Marble

01 **02** **03** **04** **05** **06** **07** **08** **09** **10** **11** **12** **13** **14** **15**

FORMATO / SIZE	PEZAS/CAJAS / PIECES/BOXES	M ² /CAJAS / M ² /BOXES	kg/CAJAS / kg/BOXES	CAJAS/PALLET / BOXES/PALLET	M ² /PALLET / M ² /PALLET	kg/PALLET / kg/PALLET
120X120	1	1,00	44,50	24	24,00	1068
60X120	2	1,00	44,50	24	24,00	1068
60X60	4	1,00	44,50	24	24,00	1068
30X60	6	1,00	44,50	24	24,00	1068

Cement



La personalidad arrolladora del cemento sobre una superficie cerámica aúna la belleza del fraguado del primero con las altas propiedades técnicas de la cerámica. Descubre nuestras colecciones en base cemento.

The overwhelming personality of cement on a ceramic surface unites the beauty of its setting and the advanced technical features of the ceramic. Discover our cement-based collections.



WABI TAUPE MATT RECT 120X260

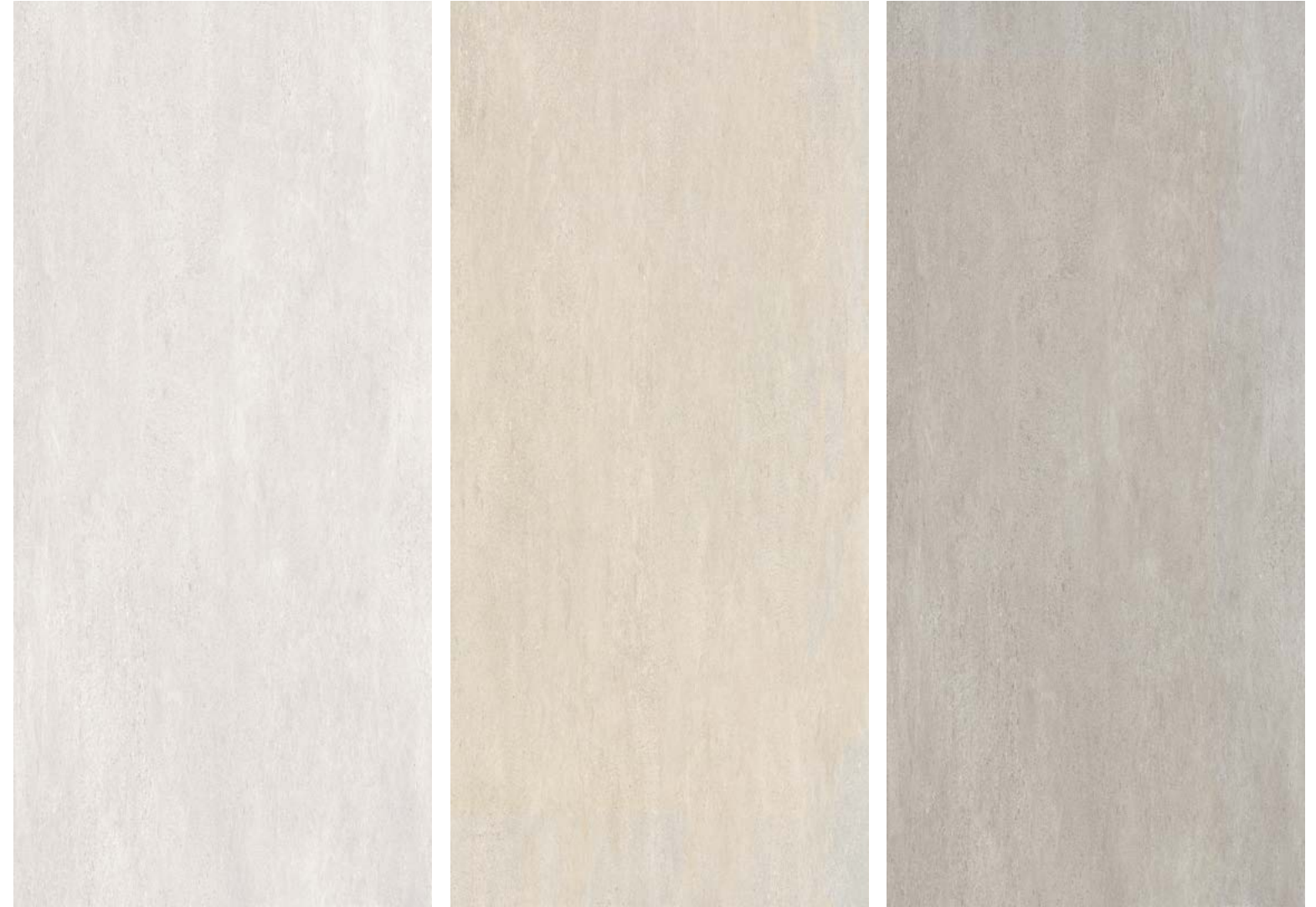

WABI BIANCO MATT RECT
120 X 260 / 48" X 102"

J30/M

WABI SABBIA MATT RECT
120 X 260 / 48" X 102"

J30/M

WABI TAUPE MATT RECT
120 X 260 / 48" X 102"

J30/M

VARIACIÓN DE DISEÑO · GRAPHIC FACES

120X260 - 3 PIEZAS/3 PIECES/3 PIÈCES

CARACTERÍSTICAS TÉCNICAS · TECHNICAL CHARACTERISTICS

- PORCELÁNICO/PORCELAIN TILES
GRÈS CERÁME/FEINSTEINZEUG
- RECTIFICADO/RECTIFIED
RECTIFIÉ/KALIBRIERT
- MASA COLOREADA/COLORED BODY
TEINTÉE DANS LA MASSE/DURCHGEFÄRBT

- VARIACION LEVE/SLIGHT VARIATION
LÉGERÉ VARIATION/LEICHT FARBSPIEL
- ANTIHIELO/FROST PROOF
RÉSISTANT AU GEL/FROSTSCHUTZ
- USO RECOMENDADO/RECOMMENED USE - RU5

FORMATO SIZE FORMAT VERPACKUNG	PZS/CAJA TILES/BOX PIÈCES/BOITE	M ² /CAJA SQM/BOX MÈTRES/BOITE	KG/CAJA KG/BOX KG/BOITE	CAJAS/PALLET BOXES/PALLET BOITES/PALLETTE	M ² /PALLET SQM/PALLET MÈTRES/PALLETTE	KG/PALLET KG/PALLET MÈTRES/PALLETTE
120X260	1	3.12	52.50	13	40.56	683

Para más información técnica, especificaciones e imágenes visite nuestra web y busque: Wabi sabi
El embalaje de los artículos está sujeto a variaciones, para obtener el dato exacto y actual se recomienda consultar la web.
For more technical information, specifications and images, visit our website and search: Wabi sabi
The packing of our items is subject to variations. To get the most accurate and updated information, we recommend to check the website.
Pour plus d'informations techniques, de spécifications et de visuels, visitez notre site web et recherchez: Wabi sabi
L'emballage des articles est sujet à variation, pour obtenir les données exactes et actuelles il est recommandé de consulter notre site web.



C2 R10 WABI BIANCO LAPATTO RECT.
120 X 120 / 48" X 48"

P05/M



M C3 R11 STRU WABI BIANCO RECT.
60 X 120 / 24" X 48" N74/M

C2 R10 WABI BIANCO LAPATTO RECT.
60 X 120 / 24" X 48" N37/M



M C3 R11 STRU WABI BIANCO RECT.
60 X 60 / 24" X 24" N33/M

C2 R10 WABI BIANCO LAPATTO RECT.
60 X 60 / 24" X 24" N43/M



M C3 R11 STRU WABI BIANCO RECT.
30 X 60 / 12" X 24" N33/M

C2 R10 WABI BIANCO LAPATTO RECT.
30 X 60 / 12" X 24" N43/M

MADERA · WOOD **P M RU5**



V3 MADAGASCAR NOCE RECT.
20 X 120 / 8" X 48"

R52/M

C3 R11 V3 ANTI-SLIP MADAGASCAR NOCE RECT.
20 X 120 / 8" X 48"

N72/M



V4 MACCHIATO BIANCO RECT.
20 X 120 / 8" X 48"

R52/M



LAPATTO

MATT

STRU

POLISHED



C2 R10 WABI SABBIA LAPATTO RECT.
120 X 120 / 48" X 48"

P05/M



M C3 R11 STRU WABI SABBIA RECT.
60 X 120 / 24" X 48" N74/M

C2 R10 WABI SABBIA LAPATTO RECT.
60 X 120 / 24" X 48" N37/M

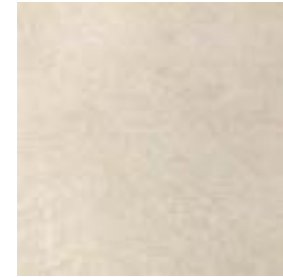

M C3 R11 STRU WABI SABBIA RECT.
60 X 60 / 24" X 24" N33/M

C2 R10 WABI SABBIA LAPATTO RECT.
60 X 60 / 24" X 24" N43/M

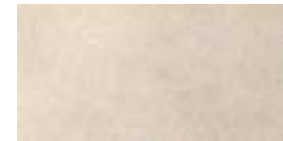

M C3 R11 STRU WABI SABBIA RECT.
30 X 60 / 12" X 24" N33/M

C2 R10 WABI SABBIA LAPATTO RECT.
30 X 60 / 12" X 24" N43/M

MADERA · WOOD **P M RU5**



V3 MADAGASCAR NOCE RECT.
20 X 120 / 8" X 48"

R52/M

C3 R11 V3 ANTI-SLIP MADAGASCAR NOCE RECT.
20 X 120 / 8" X 48"

N72/M



V4 MACCHIATO SABBIA RECT.
20 X 120 / 8" X 48"

R52/M



MATT

POLISHED

STRU

LAPATTO



C2 R10 WABI TAUPE LAPATTO RECT.
120 X 120 / 48" X 48"

P05/M



M C3 R11 STRU WABI TAUPE RECT.
60 X 120 / 24" X 48" N74/M

C2 R10 WABI TAUPE LAPATTO RECT.
60 X 120 / 24" X 48" N37/M



M C3 R11 STRU WABI TAUPE RECT.
60 X 60 / 24" X 24" N33/M

C2 R10 WABI TAUPE LAPATTO RECT.
60 X 60 / 24" X 24" N43/M



M C3 R11 STRU WABI TAUPE RECT.
30 X 60 / 12" X 24" N33/M

C2 R10 WABI TAUPE LAPATTO RECT.
30 X 60 / 12" X 24" N43/M

MADERA · WOOD **P M RU5**



V3 MADAGASCAR NOCE RECT.
20 X 120 / 8" X 48"

R52/M

C3 R11 V3 ANTI-SLIP MADAGASCAR NOCE RECT.
20 X 120 / 8" X 48"

N72/M



V4 MACCHIATO TAUPE RECT.
20 X 120 / 8" X 48"

R52/M



C2 R10 WABI GRAFITE LAPATTO RECT.
120 X 120 / 48" X 48"

P05/M



M C3 R11 STRU WABI GRAFITE RECT.
60 X 120 / 24" X 48" N74/M

C2 R10 WABI GRAFITE LAPATTO RECT.
60 X 120 / 24" X 48" N37/M



M C3 R11 STRU WABI GRAFITE RECT.
60 X 60 / 24" X 24" N33/M

C2 R10 WABI GRAFITE LAPATTO RECT.
60 X 60 / 24" X 24" N43/M



M C3 R11 STRU WABI GRAFITE RECT.
30 X 60 / 12" X 24" N33/M

C2 R10 WABI GRAFITE LAPATTO RECT.
30 X 60 / 12" X 24" N43/M

MADERA · WOOD **P M RU5**



V3 MADAGASCAR NOCE RECT.
20 X 120 / 8" X 48"

R52/M

C3 R11 V3 ANTI-SLIP MADAGASCAR NOCE RECT.
20 X 120 / 8" X 48"

N72/M

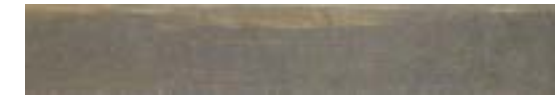

V4 MACCHIATO GRAFITE RECT.
20 X 120 / 8" X 48"

R52/M



MOSAICOS · MOSAICS

DISPONIBLE EN TODOS LOS COLORES / AVAILABLE IN ALL COLOURS

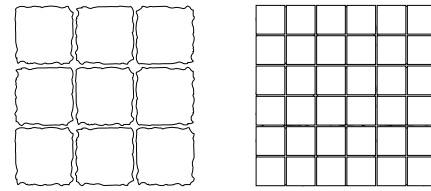

MOSAICO RUSTICO WABI
30 X 30 / 12" X 12" K63/P

MOSAICO WABI
30 X 30 (5 X 5) / 12" X 12" K01/P

PELDAÑOS · STEPS

DISPONIBLE EN TODOS LOS COLORES / AVAILABLE IN ALL COLOURS



C3 R11 PELDAÑO RECTO ANT. C3 WABI
33 X 120 / 13" X 48" K91/P

REMATE PELD. RECTO WABI
3.2 X 33 / 1.5" X 13" K36/P

PELDAÑO RECTO C1 WABI
33 X 120 / 13" X 48" K91/P

PIEZAS PISCINA · POOLS

DISPONIBLE EN: BIANCO, SABBIA Y TAUPE
AVAILABLE IN: BIANCO, SABBIA AND TAUPE

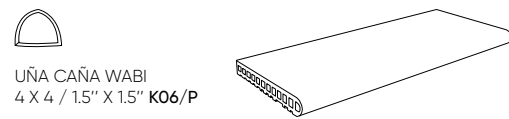

UÑA CAÑA WABI
4 X 4 / 1.5" X 1.5" K06/P

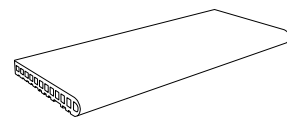

C3 R11 BORDE SKIMMER WABI
45 X 75 / 18" X 30" K93/P



UÑA ARISTA WABI
3 X 3 / 1.2" X 1.2" K06/P

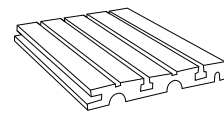

C3 R12 REJILLA WABI
24.5 X 24.5 / 9.4" X 9.4" K57/P

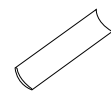

ARISTA WABI
4 X 33 / 1.5" X 13" K29/P



MEDIA CAÑA WABI
4 X 33 / 1.5" X 13" K29/P

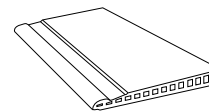

C3 R12 BORDE DESBORDANTE WABI
28 X 66.5 / 11" X 26" K94/P

RODAPIÉS · SKIRTING BOARDS

DISPONIBLE EN TODOS LOS COLORES / AVAILABLE IN ALL COLOURS

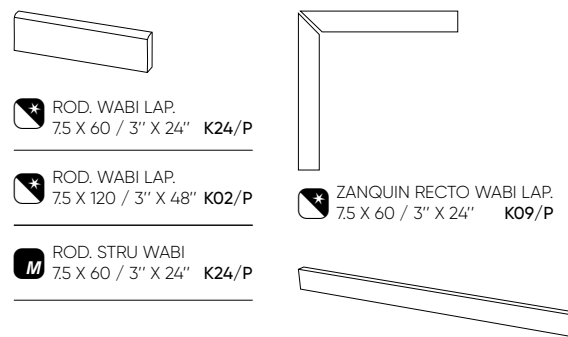

ROD. WABI LAP.
75 X 60 / 3" X 24" K24/P

ROD. WABI LAP.
75 X 120 / 3" X 48" K02/P

M ROD. STRU WABI
75 X 60 / 3" X 24" K24/P

ZANQUIN RECTO WABI LAP.
75 X 60 / 3" X 24" K09/P

TABICA WABI LAPATTO
15 X 120 / 6" X 48" K11/P



PELDAÑO RECTO WABI



BORDE SKIMMER TRAVERTINO



PELDAÑO FIOR. ANT. TRAVERTINO



BORDE DESBORDANTE TRAVERTINO

CARACTERÍSTICAS TÉCNICAS · TECHNICAL CHARACTERISTICS

- P** PORCELÁNICO/PORCELAIN TILES
GRÉS CERÁME/FEINSTEINZEUG
- V2** VARIACION LEVE/SLIGHT VARIATION
LÉGERE VARIATION/LEICHT FARBSPIEL
- RECTIFICADO/RECTIFIED**
RECTIFIÉ/KALIBRIERT
- ANTIHELO/FROST PROOF**
RÉSISTANT AU GEL/FROTSCHUTZ
- MASA COLOREADA/COLORED BODY**
TEINTÉE DANS LA MASSE/DURCHGEFÄRBT
- RUS** USO RECOMENDADO/RECOMMENED USE - RU5

FORMATO SIZE FORMAT VERPACKUNG	PZS/CAJA TILES/BOX PIÈCES/BOITE	M²/CAJA SQM/BOX MÈTRES/BOITE	KG/CAJA KG/BOX KG/BOITE	CAJAS/PALLET BOXES/PALLET BOITES/PALETTE	M²/PALLET SQM/PALLET MÈTRES/PALETTE	KG/PALLET KG/PALLET MÈTRES/PALETTE
120X260	1	3.12	52.50	13	40.56	683
120X120	1	1.44	34.28	36	51.84	1234
60X120	2	1.44	33.47	32	46.08	1071
60X60	4	1.44	31.63	30	43.20	949
30X60	6	1.08	21.83	48	51.84	1048

Para más información técnica, especificaciones e imágenes visite nuestra web y busque: Wabi sabi
El embalaje de los artículos está sujeto a variaciones, para obtener el dato exacto y actual se recomienda consultar la web.

For more technical information, specifications and images, visit our website and search: Wabi sabi
The packing of our items is subject to variations. To get the most accurate and updated information, we recommend to check the website.

Pour plus d'informations techniques, de spécifications et de visuels, visitez notre site web et recherchez : Wabi sabi
L'emballage des articles est sujet à variation, pour obtenir les données exactes et actuelles il est recommandé de consulter notre site web.



REJILLA TRAVERTINO

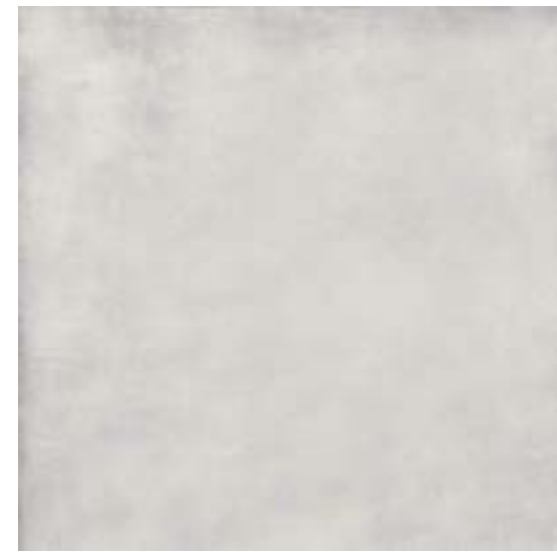

WORK B BIANCO RECT.
120 X 120 / 48" X 48" P08/M



HIGH THICKNESS WORK B BIANCO RECT.
90 X 90 / 36" X 36" N05/M

WORK B BIANCO RECT.
90 X 90 / 36" X 36" P09/M

ANTI-SLIP WORK B BIANCO RECT.
90 X 90 / 36" X 36" P18/M



WORK B CENERE RECT.
120 X 120 / 48" X 48" P08/M



HIGH THICKNESS WORK B CENERE RECT.
90 X 90 / 36" X 36" N05/M

WORK B CENERE RECT.
90 X 90 / 36" X 36" P09/M

ANTI-SLIP WORK B CENERE RECT.
90 X 90 / 36" X 36" P18/M



WORK B COAL RECT.
120 X 120 / 48" X 48" P08/M



HIGH THICKNESS WORK B COAL RECT.
90 X 90 / 36" X 36" N05/M

WORK B COAL RECT.
90 X 90 / 36" X 36" P09/M

ANTI-SLIP WORK B COAL RECT.
90 X 90 / 36" X 36" P18/M

*Espesor 20mm / thickness 0.8"



MOSAICO WORK BIANCO
30 X 30 (5 X 5) / 12" X 12" K01/P



HEXAWORK B BIANCO
21 X 18.2 / 8" X 7" P03/M



MOSAICO WORK CENERE
30 X 30 (5 X 5) / 12" X 12" K01/P



HEXAWORK B CENERE
21 X 18.2 / 8" X 7" P03/M



MOSAICO WORK COAL
30 X 30 (5 X 5) / 12" X 12" K01/P



HEXAWORK B COAL
21 X 18.2 / 8" X 7" P03/M



WORK B BIANCO RECT.
60 X 120 / 24" X 48" P11/M

ANTI-SLIP WORK B BIANCO RECT.
60 X 120 / 24" X 48" P01/M



WORK B BIANCO RECT.
60 X 60 / 24" X 24" P16/M

ANTI-SLIP WORK B BIANCO RECT.
60 X 60 / 24" X 24" P02/M



WORK B BIANCO RECT.
30 X 60 / 12" X 24" P16/M

ANTI-SLIP WORK B BIANCO RECT.
30 X 60 / 12" X 24" P02/M



WORK B CENERE RECT.
60 X 120 / 24" X 48" P11/M

ANTI-SLIP WORK B CENERE RECT.
60 X 120 / 24" X 48" P01/M

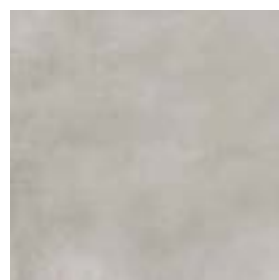

WORK B CENERE RECT.
60 X 60 / 24" X 24" P16/M

ANTI-SLIP WORK B CENERE RECT.
60 X 60 / 24" X 24" P02/M



WORK B CENERE RECT.
30 X 60 / 12" X 24" P16/M

ANTI-SLIP WORK B CENERE RECT.
30 X 60 / 12" X 24" P02/M



WORK B COAL RECT.
60 X 120 / 24" X 48" P11/M

ANTI-SLIP WORK B COAL RECT.
60 X 120 / 24" X 48" P01/M



WORK B COAL RECT.
60 X 60 / 24" X 24" P16/M

ANTI-SLIP WORK B COAL RECT.
60 X 60 / 24" X 24" P02/M



WORK B COAL RECT.
30 X 60 / 12" X 24" P16/M

ANTI-SLIP WORK B COAL RECT.
30 X 60 / 12" X 24" P02/M

CARACTERÍSTICAS TÉCNICAS · TECHNICAL CHARACTERISTICS

- PORCELÁNICO/PORCELAIN TILES
GRÈS CERÁME/FEINSTEINZEUG
- MATE/MATT
MAT/MATT

- MASA COLOREADA/COLORED BODY
TEINTÉE DANS LA MASSE/DURCHGEFÄRBT
- USO RECOMENDADO/RECOMMENED USE - RU5

FORMATO SIZE FORMAT VERPACKUNG	PZS/CAJA TILES/BOX PIÈCES/BOITE	M ² /CAJA SQM/BOX MÈTRES/BOITE	KG/CAJA KG/BOX KG/BOITE	CAJAS/PALLET BOXES/PALLET BOITES/PALETTE	M ² /PALLET SQM/PALLET MÈTRES/PALETTE	KG/PALLET KG/PALLET MÈTRES/PALETTE
120X120	1	1.44	35.31	36	51.84	1271
90X90	2	1.62	45.54	27	43.74	1230
60X120	2	1.44	34.25	32	46.08	1096
60X60	3	1.08	22.93	40	43.20	917
30X60	6	1.08	23.46	48	51.84	1126
30X30	5	0.45	10.61	60	27.00	637
21X18,2	16	0.46	9.59	100	45.86	959

Para más información técnica, especificaciones e imágenes visite nuestra web y busque: Work
El embalaje de los artículos está sujeto a variaciones, para obtener el dato exacto y actual se recomienda consultar la web.
For more technical information, specifications and images, visit our website and search: Work
The packing of our items is subject to variations. To get the most accurate and updated information, we recommend to check the website.
Pour plus d'informations techniques, de spécifications et de visuels, visitez notre site web et recherchez: Work
L'emballage des articles est sujet à variation, pour obtenir les données exactes et actuelles il est recommandé de consulter notre site web.



WORK B TAUPE RECT.
120 X 120 / 48" X 48" **P08/M**



HIGH THICKNESS WORK B TAUPE RECT.*
90 X 90 / 36" X 36" **N05/M**

WORK B TAUPE RECT.
90 X 90 / 36" X 36" **P09/M**

ANTI-SLIP WORK B TAUPE RECT.
90 X 90 / 36" X 36" **P18/M**



WORK B TAUPE RECT.
60 X 120 / 24" X 48" **P11/M**

ANTI-SLIP WORK B TAUPE RECT.
60 X 120 / 24" X 48" **P01/M**



WORK B TAUPE RECT.
60 X 60 / 24" X 24" **P16/M**

ANTI-SLIP WORK B TAUPE RECT.
60 X 60 / 24" X 24" **P02/M**



WORK B TAUPE RECT.
30 X 60 / 12" X 24" **P16/M**

ANTI-SLIP WORK B TAUPE RECT.
30 X 60 / 12" X 24" **P02/M**

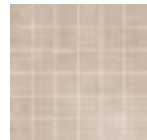

MOSAICO WORK TAUPE
30 X 30 (5 X 5) / 12" X 12" **K01/P**



HEXAWORK B TAUPE
21 X 18.2 / 8" X 7" **P03/M**

PELDAÑOS · STEPS



DISPONIBLE EN TODOS LOS COLORES / AVAILABLE IN ALL COLOURS

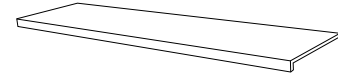

PELDAÑO RECTO ANT. C3 WORK B
33 X 120 / 13" X 48" **K91/P**

PELDAÑO RECTO C1 WORK B
33 X 120 / 13" X 48" **K91/P**



REMATE PELD. RECTO WORK B
3.2 X 33 / 1.5" X 13" **K36/P**

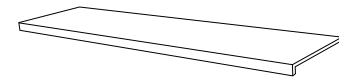

PELD. INGL. SIMPLE WORK B
30 X 120 X 3 / 12" X 48" **K91/P**

PIEZAS PISCINA · POOLS



DISPONIBLE EN TODOS LOS COLORES / AVAILABLE IN ALL COLOURS

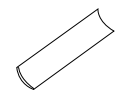

ARISTA WORK B
4 X 33 / 1.5" X 13" **K29/P**

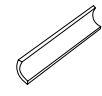

MEDIA CAÑA WORK B
4 X 33 / 1.5" X 13" **K29/P**

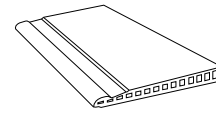

BORDE DESBORDANTE WORK B
28 X 66.5 / 11" X 26" **K94/P**

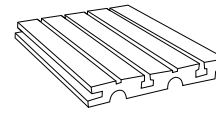

REJILLA WORK B
24.5 X 24.5 / 9.4" X 9.4" **K57/P**



UÑA ARISTA WORK B
3 X 3 / 1.2" X 1.2" **K06/P**



UÑA CAÑA WORK B
4 X 4 / 1.5" X 1.5" **K06/P**

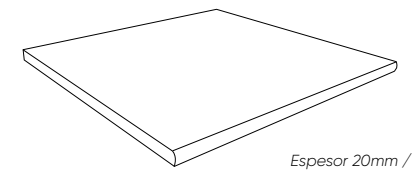

POOL EDGE HIGH THICKNESS WORK B
90 X 90 / 36" X 36" **K93/P**

Espesor 20mm / Thickness 0.8"

*Espesor 20mm / thickness 0.8"

MADERA · WOOD



WORK W NATURAL RECT.
30 X 120 / 12" X 48" **P12/M**

ANTI-SLIP WORK W NATURAL RECT.
30 X 120 / 12" X 48" **N24/M**



WORK W NATURAL RECT.
20 X 120 / 8" X 48" **P12/M**

ANTI-SLIP WORK W NATURAL RECT.
20 X 120 / 8" X 48" **N24/M**



HEXAWORK W NATURAL
21 X 18.2 / 8" X 7" **P03/M**



HEXAWORK MIX
21 X 18.2 / 8" X 7" **N39/M**



HIGH THICKNESS

20mm
0.8"



PELDAÑO RECTO WORK W NATURAL



BORDE DESBORDANTE WORK



REJILLA WORK

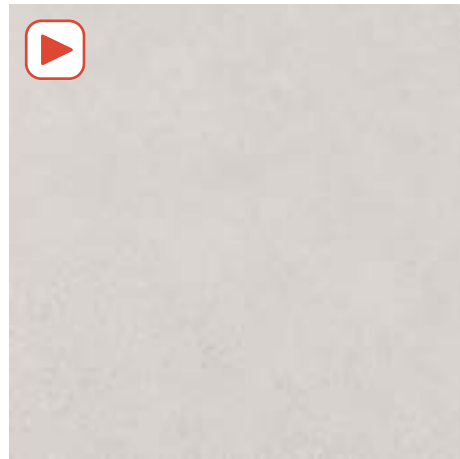

C3 R11 HIGH THICKNESS ILLINOIS WHITE RECT *
100 X 100 / 40" X 40" L24/M

C2 R10 ILLINOIS WHITE RECT
100 X 100 / 40" X 40" N23/M

C3 R12 ANTI-SLIP ILLINOIS WHITE RECT
100 X 100 / 40" X 40" J97/M

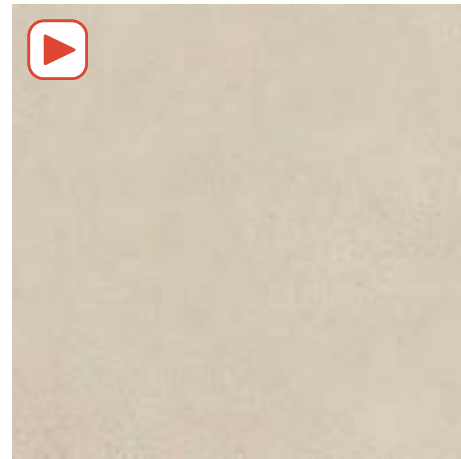

C3 R11 HIGH THICKNESS ILLINOIS BONE RECT *
100 X 100 / 40" X 40" L24/M

C2 R10 ILLINOIS BONE RECT
100 X 100 / 40" X 40" N23/M

C3 R12 ANTI-SLIP ILLINOIS BONE RECT
100 X 100 / 40" X 40" J97/M

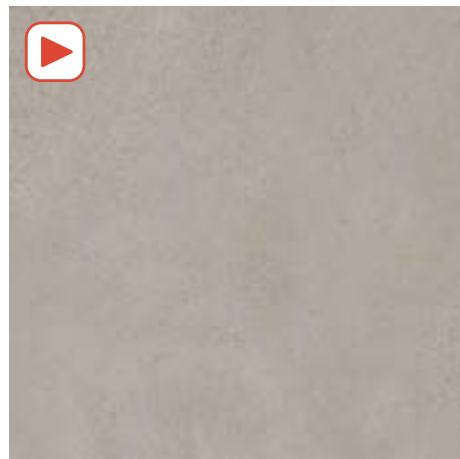

C3 R11 HIGH THICKNESS ILLINOIS GREY RECT *
100 X 100 / 40" X 40" L24/M

C2 R10 ILLINOIS GREY RECT
100 X 100 / 40" X 40" N23/M

C3 R12 ANTI-SLIP ILLINOIS GREY RECT
100 X 100 / 40" X 40" J97/M

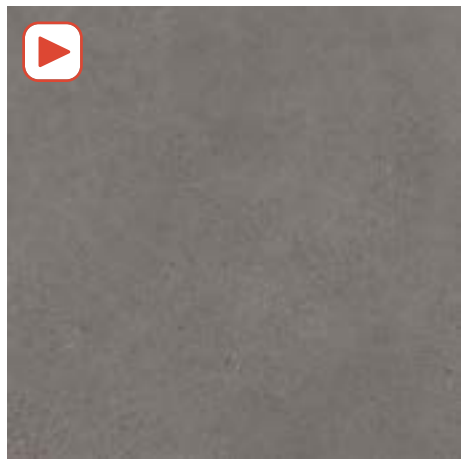

C3 R11 HIGH THICKNESS ILLINOIS GRAPHITE RECT *
100 X 100 / 40" X 40" L24/M

C2 R10 ILLINOIS GRAPHITE RECT
100 X 100 / 40" X 40" N23/M

C3 R12 ANTI-SLIP ILLINOIS GRAPHITE RECT
100 X 100 / 40" X 40" J97/M

*Espesor 20mm / thickness 0.8"

VARIACIÓN DE DISEÑO · GRAPHIC FACES

- 100X100 - 9 PIEZAS/9 PIECES/9 PIÈCES
- 60X120 - 15 PIEZAS/15 PIECES/15 PIÈCES
- 75X75 - 16 PIEZAS/16 PIECES/16 PIÈCES
- 60X60 - 30 PIEZAS/30 PIECES/30 PIÈCES

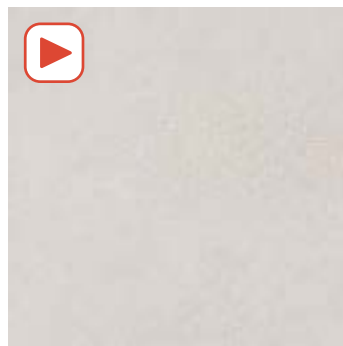

C2 R10 ILLINOIS WHITE RECT
75 X 75 / 30" X 30" J63/M

C3 R12 ANTI-SLIP ILLINOIS WHITE RECT
75 X 75 / 30" X 30" J64/M

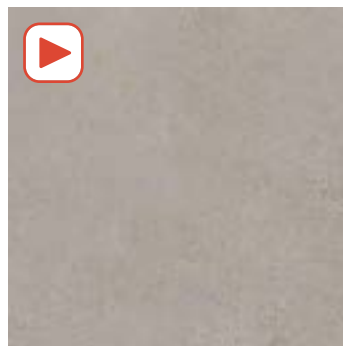

C2 R10 ILLINOIS GREY RECT
75 X 75 / 30" X 30" J63/M

C3 R12 ANTI-SLIP ILLINOIS GREY RECT
75 X 75 / 30" X 30" J64/M

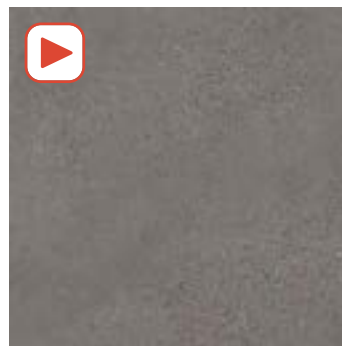

C2 R10 ILLINOIS GRAPHITE RECT
75 X 75 / 30" X 30" J63/M

C3 R12 ANTI-SLIP ILLINOIS GRAPHITE RECT
75 X 75 / 30" X 30" J64/M

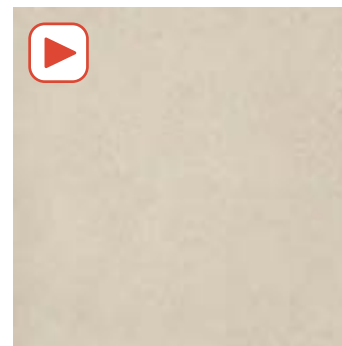

C2 R10 ILLINOIS BONE RECT
75 X 75 / 30" X 30" J63/M

C3 R12 ANTI-SLIP ILLINOIS BONE RECT
75 X 75 / 30" X 30" J64/M

ILLINOIS GREY RECT. 60X120. TRIANA. DESIERTO RECT. 20X120.





C2 R10 ILLINOIS WHITE RECT
60 X 120 / 24" X 48" **J65/M**

C3 R12 ANTI-SLIP ILLINOIS WHITE RECT
60 X 120 / 24" X 48" **J66/M**

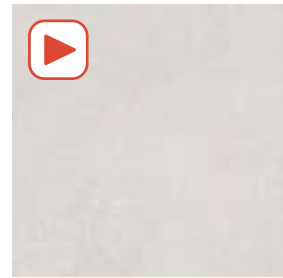

C2 R10 ILLINOIS WHITE RECT.
60 X 60 / 24" X 24" **P17/M**



MALLA ILLINOIS WHITE
30 X 30 (5 X 5) / 12" X 12" **K01/P**



C2 R10 ILLINOIS GREY RECT
60 X 120 / 24" X 48" **J65/M**

C3 R12 ANTI-SLIP ILLINOIS GREY RECT
60 X 120 / 24" X 48" **J66/M**

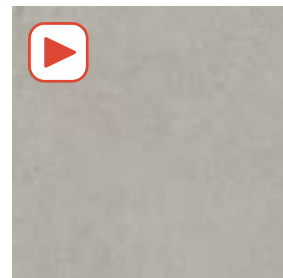

C2 R10 ILLINOIS GREY RECT.
60 X 60 / 24" X 24" **P17/M**



MALLA ILLINOIS GREY
30 X 30 (5 X 5) / 12" X 12" **K01/P**



C2 R10 ILLINOIS GRAPHITE RECT
60 X 120 / 24" X 48" **J65/M**

C3 R12 ANTI-SLIP ILLINOIS GRAPHITE RECT
60 X 120 / 24" X 48" **J66/M**



C2 R10 ILLINOIS GRAPHITE RECT.
60 X 60 / 24" X 24" **P17/M**



MALLA ILLINOIS GRAPHITE
30 X 30 (5 X 5) / 12" X 12" **K01/P**



C2 R10 ILLINOIS BONE RECT
60 X 120 / 24" X 48" **J65/M**

C3 R12 ANTI-SLIP ILLINOIS BONE RECT
60 X 120 / 24" X 48" **J66/M**

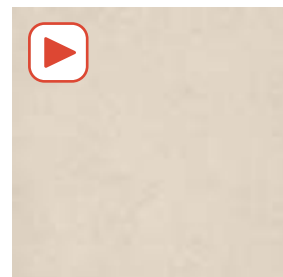

C2 R10 ILLINOIS BONE RECT.
60 X 60 / 24" X 24" **P17/M**



MALLA ILLINOIS BONE
30 X 30 (5 X 5) / 12" X 12" **K01/P**

PELDAÑOS · STEPS

DISPONIBLE EN TODOS LOS COLORES / AVAILABLE IN ALL COLORS

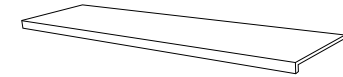

PELDAÑO RECTO ANT. C3 ILLINOIS
33 X 120 / 13" X 48" **K91/P**

RODAPIÉS · SKIRTING BOARDS

DISPONIBLE EN TODOS LOS COLORES / AVAILABLE IN ALL COLORS

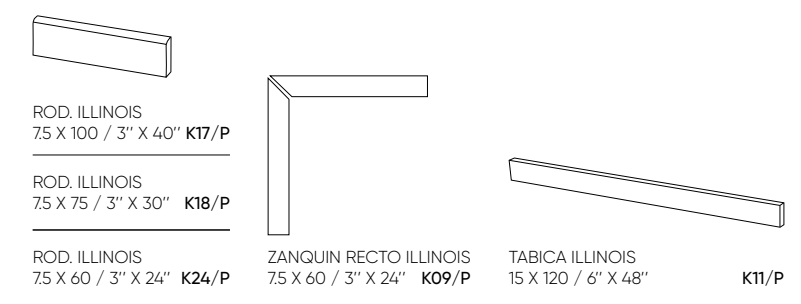

ROD. ILLINOIS
75 X 100 / 3" X 40" **K17/P**

ROD. ILLINOIS
75 X 75 / 3" X 30" **K18/P**

ROD. ILLINOIS
75 X 60 / 3" X 24" **K24/P**

ZANQUIN RECTO ILLINOIS
75 X 60 / 3" X 24" **K09/P**

TABICA ILLINOIS
15 X 120 / 6" X 48" **K11/P**



ILLINOIS WHITE RECT. 60X60. ILLINOIS WHITE RECT 60X120.
MALLA ILLINOIS WHITE 30X30 (5X5). TRIANA CAOBA RECT. 20X120.

CARACTERÍSTICAS TÉCNICAS · TECHNICAL CHARACTERISTICS

- P** PORCELÁNICO/PORCELAIN TILES
GRÈS CERÁME/FEINSTEINZEUG
- M** MATE/MATT
MAT/MATT
- RECTIFICADO/RECTIFIED**
RECTIFIÉ/KALIBRIERT
- V2** VARIACION LEVE/SLIGHT VARIATION
LÉGERÉ VARIATION/LEICHT FARBSPIEL
- ANTIHIELO/FROST PROOF**
RÉSISTANT AU GEL/FROSTSCHUTZ
- RU5** USO RECOMENDADO/RECOMMENED USE - RU5

FORMATO SIZE FORMAT VERPACKUNG	PZS/CAJA TILES/BOX PIÈCES/BOITE	M²/CAJA SQM/BOX MÈTRES/BOITE	KG/CAJA KG/BOX KG/BOITE	CAJAS/PALLET BOXES/PALLET BOITES/PALETTE	M²/PALLET SQM/PALLET MÈTRES/PALETTE	KG/PALLET KG/PALLET MÈTRES/PALETTE
100X100	1	1.00	22.56	54	54.00	1218
75X75	2	1.11	25.55	42	46.62	1073
60X120	2	1.44	31.00	32	46.08	992
60X60	4	1.44	32.93	30	43.20	988

Para más información técnica, especificaciones e imágenes visite nuestra web y busque: Illinois
El embalaje de los artículos está sujeto a variaciones, para obtener el dato exacto y actual se recomienda consultar la web.
For more technical information, specifications and images, visit our website and search: Illinois
The packing of our items is subject to variations. To get the most accurate and updated information, we recommend to check the website.
Pour plus d'informations techniques, de spécifications et de visuels, visitez notre site web et recherchez: Illinois
L'emballage des articles est sujet à variation, pour obtenir les données exactes et actuelles il est recommandé de consulter notre site web.



M **RU5** NAXOS WHITE MATT RECT
60 X 120 / 24" X 48" **N10/M**

G **RU4** NAXOS WHITE POL RECT
59 X 119 / 23" X 47" **P50/M**



M **RU5** NAXOS GREY MATT RECT
60 X 120 / 24" X 48" **N10/M**

G **RU4** NAXOS GREY POL RECT
59 X 119 / 23" X 47" **P50/M**



M **RU5** NAXOS SEA FOAM MATT RECT
60 X 120 / 24" X 48" **N10/M**

G **RU4** NAXOS SEA FOAM POL RECT
59 X 119 / 23" X 47" **P50/M**

VARIACIÓN DE DISEÑO · GRAPHIC FACES



60X120 - 12 PIEZAS/12 PIECES/12 PIÈCES

RODAPIÉS · SKIRTING BOARDS **P** **V2** **S**

DISPONIBLE EN TODOS LOS COLORES / AVAILABLE IN ALL COLORS

CARACTERÍSTICAS TÉCNICAS · TECHNICAL CHARACTERISTICS

- P** PORCELÁNICO/PORCELAIN TILES
GRÉS CERÁME/FEINSTEINZEUG
- V2** VARIACION LEVE/SLIGHT VARIATION
LÉGERÉ VARIATION/LEICHT FARBSPIEL
- S** RECTIFICADO/RECTIFIED
RECTIFIÉ/KALIBRIERT
- S** ANTIHIELO/FROST PROOF
RÉSISTANT AU GEL/FROSTSCHUTZ



M ROD. NAXOS MATT
7.5 X 60 / 3" X 24" **K24/P**

G ROD. NAXOS POL.
7.5 X 59 / 3" X 23" **K29/P**

FORMATO SIZE FORMAT VERPACKUNG	PZS/CAJA TILES/BOX PIÈCES/BOITE	M²/CAJA SQM/BOX MÈTRES/BOITE	KG/CAJA KG/BOX KG/BOITE	CAJAS/PALLET BOXES/PALLET BOITES/PALETTE	M²/PALLET SQM/PALLET MÈTRES/PALETTE	KG/PALLET KG/PALLET MÈTRES/PALETTE
60X120	2	1.44	33.43	30	43.20	1003
59X119	2	1.40	33.22	27	37.80	897

Para más información técnica, especificaciones e imágenes visite nuestra web y busque: Naxos
El embalaje de los artículos está sujeto a variaciones, para obtener el dato exacto y actual se recomienda consultar la web.
For more technical information, specifications and images, visit our website and search: Naxos
The packing of our items is subject to variations. To get the most accurate and updated information, we recommend to check the website.
Pour plus d'informations techniques, de spécifications et de visuels, visitez notre site web et recherchez : Naxos
L'emballage des articles est sujet à variation, pour obtenir les données exactes et actuelles il est recommandé de consulter notre site web.

ALPI GREEN POL. RECT. 120X260 NAXOS SEA FOAM MATT RECT. 60X120 OFF VICTORIAN GREEN MATT 4.3X24.3 ON VICTORIAN GREEN GLOSS 4.3X24.3





PLUS PEARL POLISHED RECT
60 X 120 / 24" X 48" J18/M



PLUS CREAM POLISHED RECT
60 X 120 / 24" X 48" J18/M

VARIACIÓN DE DISEÑO · GRAPHIC FACES

60X120 - 8 PIEZAS/8 PIECES/8 PIÈCES

RODAPIÉS · SKIRTING BOARDS



DISPONIBLE EN TODOS LOS COLORES / AVAILABLE IN ALL COLORS

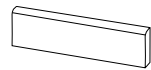

ROD. PLUS POL.
7.5 X 60 / 3" X 24" K29/P

CARACTERÍSTICAS TÉCNICAS · TECHNICAL CHARACTERISTICS

- P** PORCELÁNICO/PORCELAIN TILES
GRÉS CERÁME/FEINSTEINZEUG
- V2** VARIACION LEVE/SLIGHT VARIATION
LÉGERÉ VARIATION/LEICHT FARBSPIEL
- E** ESMALTE PULIDO/GLAZE POLISHED SHINY
ÉMAIL POLI BRILLANT/HOCHGLANZ POLIERT
- S** ANTIHELO/FROST PROOF
RÉSISTANT AU GEL/FROSTSCHUTZ
- R** RECTIFICADO/RECTIFIED
RECTIFIÉ/KALIBRIERT
- RU4** USO RECOMENDADO/RECOMMENED USE - RU4

FORMATO SIZE FORMAT VERPACKUNG	PZS/CAJA TILES/BOX PIÈCES/BOITE	M²/CAJA SQM/BOX MÈTRES/BOITE	KG/CAJA KG/BOX KG/BOITE	CAJAS/PALLET BOXES/PALLET BOITES/PALETTE	M²/PALLET SQM/PALLET MÈTRES/PALETTE	KG/PALLET KG/PALLET MÈTRES/PALETTE
60X120	2	1.44	36.97	32	46.08	1183

Para más información técnica, especificaciones e imágenes visite nuestra web y busque: Plus
El embalaje de los artículos está sujeto a variaciones, para obtener el dato exacto y actual se recomienda consultar la web.
For more technical information, specifications and images, visit our website and search: Plus
The packing of our items is subject to variations. To get the most accurate and updated information, we recommend to check the website.
Pour plus d'informations techniques, de spécifications et de visuels, visitez notre site web et recherchez : Plus
L'emballage des articles est sujet à variation, pour obtenir les données exactes et actuelles il est recommandé de consulter notre site web.



PLUS CREAM POLISHED RECT 60X120.



LEEDS WHITE RECT.
40 X 120 / 16" X 48" **N28/M**



DERBY WHITE RECT.
40 X 120 / 16" X 48" **N30/M**



LEEDS GREY RECT.
40 X 120 / 16" X 48" **N28/M**



DERBY GREY RECT.
40 X 120 / 16" X 48" **N30/M**

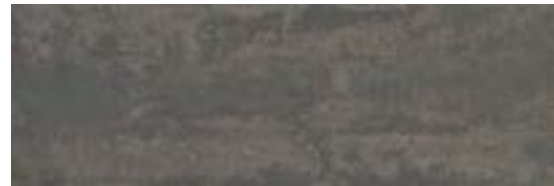

LEEDS COAL RECT.
40 X 120 / 16" X 48" **N28/M**



DERBY COAL RECT.
40 X 120 / 16" X 48" **N30/M**



DECOR FLORESTA WHITE
40 X 120 / 16" X 48" **K66/P**



CLAYTON MIX RECT.
40 X 120 / 16" X 48" **N30/M**



DECOR GOLDEN PARK
40 X 120 / 16" X 48" **K81/P**



DECOR LEEDS
40 X 120 / 16" X 48" **K72/P**



LEEDS GREY

DERBY GREY



LEEDS COAL RECT. 40X120. DERBY COAL RECT. 40X120. DECOR GOLDEN PARK 40X120.

CARACTERÍSTICAS TÉCNICAS - TECHNICAL CHARACTERISTICS

- P** PORCELÁNICO/PORCELAIN TILES
GRÈS CERÁME/FEINSTEINZEUG
- M** MATE/MATT
MAT/MATT
- R** RECTIFICADO/RECTIFIED
RECTIFIÉ/KALIBRIERT
- V3** VARIACION MODERADA/MODERATE VARIATION
MODÉRÉE VARIATION/MITTLERES FARBSPIEL
- F** ANTIHIELO/FROST PROOF
RÉSISTANT AU GEL/FROSTSCHUTZ
- RU5** USO RECOMENDADO/RECOMMENED USE - RU5

FORMATO SIZE FORMAT VERPACKUNG	PZS/CAJA TILES/BOX PIÈCES/BOITE	M ² /CAJA SQM/BOX MÈTRES/BOITE	KG/CAJA KG/BOX KG/BOITE	CAJAS/PALLET BOXES/PALLET BOITES/PALETTE	M ² /PALLET SQM/PALLET MÈTRES/PALETTE	KG/PALLET KG/PALLET MÈTRES/PALETTE
40X120	3	1.44	34.75	40	57.60	1390

Para más información técnica, especificaciones e imágenes visite nuestra web y busque: Leeds
El embalaje de los artículos está sujeto a variaciones, para obtener el dato exacto y actual se recomienda consultar la web.
For more technical information, specifications and images, visit our website and search: Leeds
The packing of our items is subject to variations. To get the most accurate and updated information, we recommend to check the website.
Pour plus d'informations techniques, de spécifications et de visuels, visitez notre site web et recherchez: Leeds
L'emballage des articles est sujet à variation, pour obtenir les données exactes et actuelles il est recommandé de consulter notre site web.



OLD STREET GREY RECT.
40 X 120 / 16" X 48"

N51/M



OLD STREET IVORY RECT.
40 X 120 / 16" X 48"

N51/M



OHIO IVORY
23 X 26 / 9" X 10" N14/M



NOTTING HILL GREY RECT.
40 X 120 / 16" X 48"

R32/M



NOTTING HILL IVORY RECT.
40 X 120 / 16" X 48"

R32/M



OHIO GREY
23 X 26 / 9" X 10" N14/M



UNDERGROUND MIX GREY RECT.
40 X 120 / 16" X 48"

R32/M



UNDERGROUND MIX IVORY RECT.
40 X 120 / 16" X 48"

R32/M



OHIO GRAPHITE
23 X 26 / 9" X 10" N14/M



IOWA GREY MIX
23 X 26 / 9" X 10" R73/M



IOWA IVORY MIX
23 X 26 / 9" X 10" R73/M

CARACTERÍSTICAS TÉCNICAS · TECHNICAL CHARACTERISTICS



PASTA BLANCA/WHITE BODY
PÂTE BLANCHE/WEISSSCHERBIG



RECTIFICADO/RECTIFIED
RECTIFIÉ/KALIBRIERT



REVESTIMIENTO/WALL TILE
FAÏENCE/WANDFLIESEN



VARIACION MODERADA/MODERATE VARIATION
MODÉRÉE VARIATION/MITTLERES FARBSPIEL



MATE/MATT
MAT/MATT

FORMATO SIZE FORMAT VERPACKUNG	PZS/CAJA TILES/BOX PIÈCES/BOITE	M²/CAJA SQM/BOX MÈTRES/BOITE	KG/CAJA KG/BOX KG/BOITE	CAJAS/PALLET BOXES/PALLET BOITES/PALETTE	M²/PALLET SQM/PALLET MÈTRES/PALETTE	KG/PALLET KG/PALLET MÈTRES/PALETTE
40X120	3	1.44	27.77	28	40.32	777
23X26	16	0.75	14.22	60	45.00	853

Para más información técnica, especificaciones e imágenes visite nuestra web y busque: Old street
El embalaje de los artículos está sujeto a variaciones, para obtener el dato exacto y actual se recomienda consultar la web.

For more technical information, specifications and images, visit our website and search: Old street
The packing of our items is subject to variations. To get the most accurate and updated information, we recommend to check the website.

Pour plus d'informations techniques, de spécifications et de visuels, visitez notre site web et recherchez : Old street
L'emballage des articles est sujet à variation, pour obtenir les données exactes et actuelles il est recommandé de consulter notre site web.



NOTTING HILL GREY

OLD STREET GREY



OLD STREET GREY RECT. 40X120. NOTTING HILL GREY RECT. 40X120.



TWIST WHITE RECT.
40 X 120 / 16" X 48" **N51/M**



RIZZO WHITE RECT.
40 X 120 / 16" X 48" **R32/M**



ZOOOCO WHITE RECT.
40 X 120 / 16" X 48" **R32/M**



DECOR ZUMA WHITE
40 X 120 / 16" X 48" **K40/P**



DECOR SET(3) LEAVEMINT
40 X 120 / 16" X 48" **K81/P**



TWIST PEARL RECT.
40 X 120 / 16" X 48" **N51/M**



RIZZO PEARL RECT.
40 X 120 / 16" X 48" **R32/M**



ZOOOCO PEARL RECT.
40 X 120 / 16" X 48" **R32/M**



DECOR ZUMA PEARL
40 X 120 / 16" X 48" **K40/P**



TWIST LINEN RECT.
40 X 120 / 16" X 48" **N51/M**



RIZZO LINEN RECT.
40 X 120 / 16" X 48" **R32/M**



ZOOOCO LINEN RECT.
40 X 120 / 16" X 48" **R32/M**

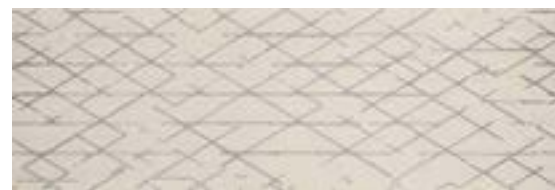

DECOR ZUMA LINEN
40 X 120 / 16" X 48" **K40/P**



TWIST WHITE RECT-40X120.DECOR ZUMA WHITE 40X120.

CARACTERÍSTICAS TÉCNICAS · TECHNICAL CHARACTERISTICS

- PB** PASTA BLANCA / WHITE BODY
PÂTE BLANCHE / WEISSSCHERBIG
- RE** RECTIFICADO / RECTIFIED
RECTIFIÉ / KALIBRIERT
- RV** REVESTIMIENTO / WALL TILE
FAÏENCE / WANDFLIESEN
- V1** ASPECTO UNIFORME / UNIFORM APPEARANCE
APPARENCE UNIFORME / KEINE FARBSPIEL
- M** MATE / MATT
MAT / MATT

FORMATO SIZE FORMAT VERPACKUNG	PZS/CAJA TILES/BOX PIÈCES/BOITE	M²/CAJA SQM/BOX MÈTRES/BOITE	KG/CAJA KG/BOX KG/BOITE	CAJAS/PALLET BOXES/PALLET BOITES/PALETTE	M²/PALLET SQM/PALLET MÈTRES/PALETTE	KG/PALLET KG/PALLET MÈTRES/PALETTE
40X120	3	1.44	27.80	20	28.80	556

Para más información técnica, especificaciones e imágenes visite nuestra web y busque: Twist
El embalaje de los artículos está sujeto a variaciones, para obtener el dato exacto y actual se recomienda consultar la web.
For more technical information, specifications and images, visit our website and search: Twist
The packing of our items is subject to variations. To get the most accurate and updated information, we recommend to check the website.
Pour plus d'informations techniques, de spécifications et de visuels, visitez notre site web et recherchez: Twist
L'emballage des articles est sujet à variation, pour obtenir les données exactes et actuelles il est recommandé de consulter notre site web.

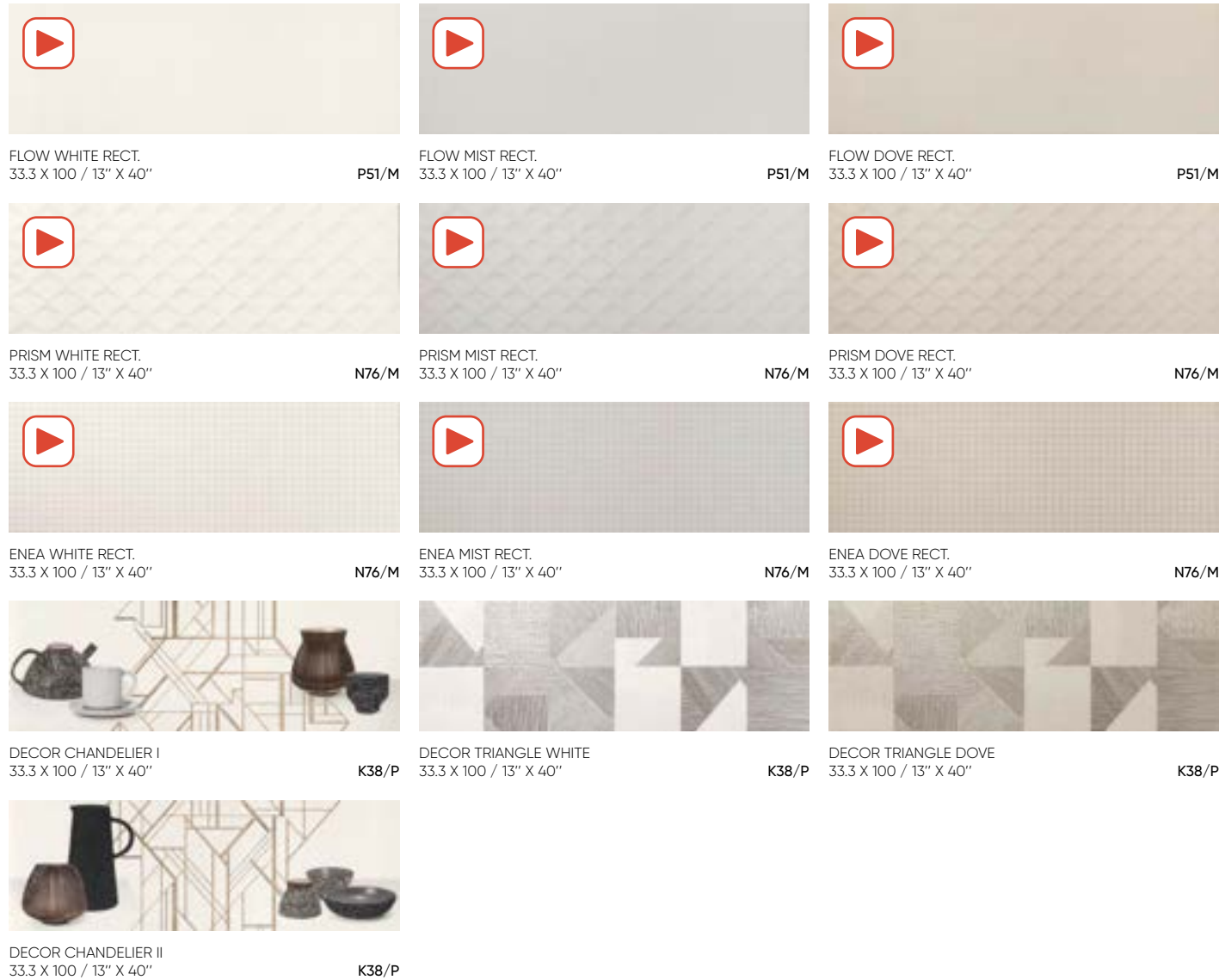

FLOW MIST RECT. 33,3X100. PRISM MIST RECT. 33,3X100

CARACTERÍSTICAS TÉCNICAS - TECHNICAL CHARACTERISTICS

- PB** PASTA BLANCA / WHITE BODY
PÂTE BLANCHE / WEISSSCHERBIG
- RE** RECTIFICADO / RECTIFIED
RECTIFIÉ / KALIBRIERT
- V1** REVESTIMIENTO / WALL TILE
FAÏENCE / WANDFLIESEN
- V1** ASPECTO UNIFORME / UNIFORM APPEARANCE
APPARENCE UNIFORME / KEINE FARBSPIEL
- M** MATE / MATT
MAT / MATT

FORMATO SIZE FORMAT VERPACKUNG	PZS/CAJA TILES/BOX PIÈCES/BOITE	M²/CAJA SQM/BOX MÈTRES/BOITE	KG/CAJA KG/BOX KG/BOITE	CAJAS/PALLET BOXES/PALLET BOITES/PALETTE	M²/PALLET SQM/PALLET MÈTRES/PALETTE	KG/PALLET KG/PALLET MÈTRES/PALETTE
33,3X100	4	1.33	24.65	48	63.84	1183

Para más información técnica, especificaciones e imágenes visite nuestra web y busque: Flow
El embalaje de los artículos está sujeto a variaciones, para obtener el dato exacto y actual se recomienda consultar la web.
For more technical information, specifications and images, visit our website and search: Flow
The packing of our items is subject to variations. To get the most accurate and updated information, we recommend to check the website.
Pour plus d'informations techniques, de spécifications et de visuels, visitez notre site web et recherchez: Flow
L'emballage des articles est sujet à variation, pour obtenir les données exactes et actuelles il est recommandé de consulter notre site web.



CHIC WHITE RECT. 31,6X90, PENTA WHITE RECT. 31,6X90, ILLINOIS GRAPHITE RECT. 60X60.

CARACTERÍSTICAS TÉCNICAS · TECHNICAL CHARACTERISTICS

- PB** PASTA BLANCA / WHITE BODY
PÂTE BLANCHE / WEISSSCHERBIG
- RE** RECTIFICADO / RECTIFIED
RECTIFIÉ / KALIBRIERT
- R** REVESTIMIENTO / WALL TILE
FAÏENCE / WANDFLIESEN
- V4** VARIACION FUERTE / SUBSTANTIAL VARIATION
FORTE VARIATION / HOHES FARBSPIEL
- M** MATE / MATT
MAT / MATT

FORMATO SIZE FORMAT VERPACKUNG	PZS/CAJA TILES/BOX PIÈCES/BOITE	M ² /CAJA SQM/BOX MÈTRES/BOITE	KG/CAJA KG/BOX KG/BOITE	CAJAS/PALLET BOXES/PALLET BOITES/PALETTE	M ² /PALLET SQM/PALLET MÈTRES/PALETTE	KG/PALLET KG/PALLET MÈTRES/PALETTE
31,6X90	4	1.14	19.06	48	54.60	915

Para más información técnica, especificaciones e imágenes visite nuestra web y busque: Chic
El embalaje de los artículos está sujeto a variaciones, para obtener el dato exacto y actual se recomienda consultar la web.
For more technical information, specifications and images, visit our website and search: Chic
The packing of our items is subject to variations. To get the most accurate and updated information, we recommend to check the website.
Pour plus d'informations techniques, de spécifications et de visuels, visitez notre site web et recherchez: Chic
L'emballage des articles est sujet à variation, pour obtenir les données exactes et actuelles il est recommandé de consulter notre site web.



SHARON PEARL RECT. 30 X 90 / 12" X 36" R19/M CATHY PEARL RECT. 30 X 90 / 12" X 36" N52/M DECOR WOODY PEARL 30 X 90 / 12" X 36" K53/P

SHARON GREY RECT. 30 X 90 / 12" X 36" R19/M CATHY GREY RECT. 30 X 90 / 12" X 36" N52/M DECOR WOODY GREY 30 X 90 / 12" X 36" K53/P

SHARON CREAM RECT. 30 X 90 / 12" X 36" R19/M CATHY CREAM RECT. 30 X 90 / 12" X 36" N52/M DECOR WOODY CREAM 30 X 90 / 12" X 36" K53/P



CARACTERÍSTICAS TÉCNICAS · TECHNICAL CHARACTERISTICS

- PB** PASTA BLANCA / WHITE BODY
PÂTE BLANCHE / WEISSSCHERBIG
- V2** RECTIFICADO / RECTIFIED
RECTIFIÉ / KALIBRIERT
- M** REVESTIMIENTO / WALL TILE
FAÏENCE / WANDFLIESEN
- V2** VARIACION LEVE / SLIGHT VARIATION
LÉGERÉ VARIATION / LEICHT FARBSPIEL
- M** MATE / MATT
MAT / MATT

FORMATO SIZE FORMAT VERPACKUNG	PZS/CAJA TILES/BOX PIÈCES/BOITE	M²/CAJA SQM/BOX MÈTRES/BOITE	KG/CAJA KG/BOX KG/BOITE	CAJAS/PALLET BOXES/PALLET BOITES/PALETTE	M²/PALLET SQM/PALLET MÈTRES/PALETTE	KG/PALLET KG/PALLET MÈTRES/PALETTE
30X90	4	1.08	19.38	60	64.80	1163

Para más información técnica, especificaciones e imágenes visite nuestra web y busque: Sharon
El embalaje de los artículos está sujeto a variaciones, para obtener el dato exacto y actual se recomienda consultar la web.
For more technical information, specifications and images, visit our website and search: Sharon
The packing of our items is subject to variations. To get the most accurate and updated information, we recommend to check the website.
Pour plus d'informations techniques, de spécifications et de visuels, visitez notre site web et recherchez : Sharon
L'emballage des articles est sujet à variation, pour obtenir les données exactes et actuelles il est recommandé de consulter notre site web.



TIMELESS WHITE RECT. 30 X 90 / 12" X 36" R19/M TIMELESS SAND RECT. 30 X 90 / 12" X 36" R19/M

HANNIE WHITE RECT. 30 X 90 / 12" X 36" N52/M HANNIE SAND RECT. 30 X 90 / 12" X 36" N52/M

DECOR TIMELESS WHITE 30 X 90 / 12" X 36" K53/P DECOR TIMELESS SAND 30 X 90 / 12" X 36" K53/P

URSULA MIX SERENITY RECT. 30 X 90 / 12" X 36" N52/M URSULA MIX SAND RECT. 30 X 90 / 12" X 36" N52/M



CARACTERÍSTICAS TÉCNICAS · TECHNICAL CHARACTERISTICS

- PB** PASTA BLANCA / WHITE BODY
PÂTE BLANCHE / WEISSSCHERBIG
- V2** RECTIFICADO / RECTIFIED
RECTIFIÉ / KALIBRIERT
- B** REVESTIMIENTO / WALL TILE
FAÏENCE / WANDFLIESEN
- V2** VARIACION LEVE / SLIGHT VARIATION
LÉGERÉ VARIATION / LEICHT FARBSPIEL
- B** BRILLO / SHINE
BRILLANT / GLÄNZEN

FORMATO SIZE FORMAT VERPACKUNG	PZS/CAJA TILES/BOX PIÈCES/BOITE	M²/CAJA SQM/BOX MÈTRES/BOITE	KG/CAJA KG/BOX KG/BOITE	CAJAS/PALLET BOXES/PALLET BOITES/PALETTE	M²/PALLET SQM/PALLET MÈTRES/PALETTE	KG/PALLET KG/PALLET MÈTRES/PALETTE
30X90	4	1.08	20.45	60	64.80	1227

Para más información técnica, especificaciones e imágenes visite nuestra web y busque: Timeless
El embalaje de los artículos está sujeto a variaciones, para obtener el dato exacto y actual se recomienda consultar la web.
For more technical information, specifications and images, visit our website and search: Timeless
The packing of our items is subject to variations. To get the most accurate and updated information, we recommend to check the website.
Pour plus d'informations techniques, de spécifications et de visuels, visitez notre site web et recherchez : Timeless
L'emballage des articles est sujet à variation, pour obtenir les données exactes et actuelles il est recommandé de consulter notre site web.



GAMY GREY 25X75KLEN GREY 25X75KLEN GREY 60X60

KLEN BLUE 25X75KLEN COCONUT MILK 25X75KLEN GREY 60X60





KLEN COCONUT MILK 25 X 75 / 10" X 30" P57/M
 KLEN PEARL 25 X 75 / 10" X 30" P57/M
 KLEN GREY 25 X 75 / 10" X 30" P57/M
 KLEN PALLADIUM 25 X 75 / 10" X 30" P57/M
 KLEN TERRACOTA 25 X 75 / 10" X 30" P57/M
 KLEN BLUE 25 X 75 / 10" X 30" P57/M

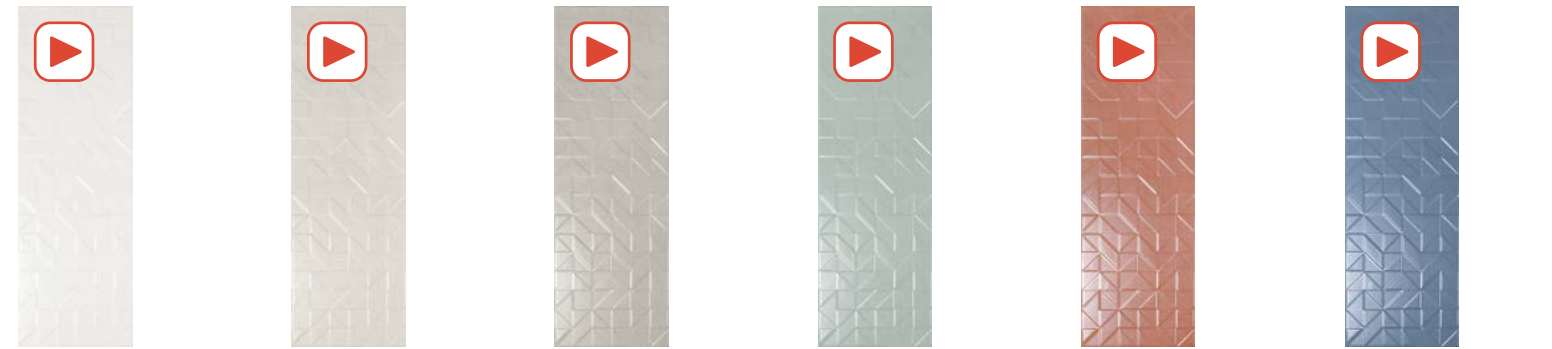

GAMY COCONUT MILK 25 X 75 / 10" X 30" P58/M
 GAMY PEARL 25 X 75 / 10" X 30" P58/M
 GAMY GREY 25 X 75 / 10" X 30" P58/M
 GAMY PALLADIUM 25 X 75 / 10" X 30" P58/M
 GAMY TERRACOTA 25 X 75 / 10" X 30" P58/M
 GAMY BLUE 25 X 75 / 10" X 30" P58/M

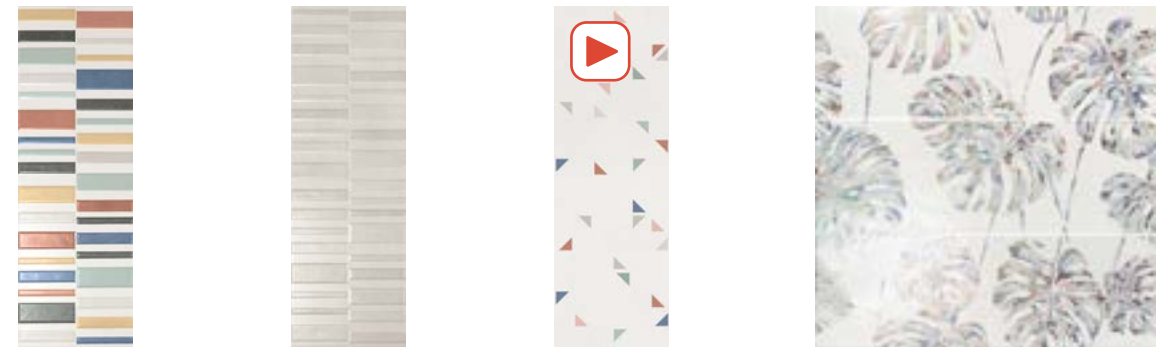

LIN COCONUT MILK 25 X 75 / 10" X 30" P58/M
 LIN PEARL 25 X 75 / 10" X 30" P58/M
 ORION COCONUT MILK 25 X 75 / 10" X 30" P58/M
 DECOR SET (3) MAY COCONUT MILK 25 X 75 / 10" X 30" K71/P



WEB COLLECTION
 PB U M C2 V2 RU5



PAVIMENTO RECOMENDADO · RECOMMENDED FLOORING

P M C2 V3 RU5



KLEN GREY 60 X 60 / 24" X 24" J27/M
 KLEN PEARL 60 X 60 / 24" X 24" J27/M

SERENISSIMA GREY RECT. 60 X 60 / 24" X 24" N55/M
 SERENISSIMA PEARL RECT. 60 X 60 / 24" X 24" N55/M

RODAPIÉS · SKIRTING BOARDS

P M V3

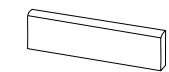

ROD. KLEN 75 X 60 / 3" X 24" K24/P

CARACTERÍSTICAS TÉCNICAS · TECHNICAL CHARACTERISTICS

- PB** PASTA BLANCA/WHITE BODY
PÂTE BLANCHE/WEISSSCHERBIG
- S** SATINADO/SATIN
SATIN/SATINIERT
- R** REVESTIMIENTO/WALL TILE
FAÏENCE/WANDFLIESEN
- V2** VARIACION LEVE/SLIGHT VARIATION
LÉGERÉ VARIATION/LEICHT FARBSPIEL

FORMATO SIZE FORMAT VERPACKUNG	PZS/CAJA TILES/BOX PIÈCES/BOITE	M ² /CAJA SQM/BOX MÈTRES/BOITE	KG/CAJA KG/BOX KG/BOITE	CAJAS/PALLET BOXES/PALLET BOITES/PALETTE	M ² /PALLET SQM/PALLET MÈTRES/PALETTE	KG/PALLET KG/PALLET MÈTRES/PALETTE
25X75	6	1.13	17.19	21	23.63	361

Para más información técnica, especificaciones e imágenes visite nuestra web y busque: Klen
 El embalaje de los artículos está sujeto a variaciones, para obtener el dato exacto y actual se recomienda consultar la web.
 For more technical information, specifications and images, visit our website and search: Klen
 The packing of our items is subject to variations. To get the most accurate and updated information, we recommend to check the website.
 Pour plus d'informations techniques, de spécifications et de visuels, visitez notre site web et recherchez: Klen
 L'emballage des articles est sujet à variation, pour obtenir les données exactes et actuelles il est recommandé de consulter notre site web.

Cotto



Clay is a very interesting and fundamental material: it is earth, it is water and, with fire, it takes shape and life.

La arcilla es un material muy interesante y fundamental: es tierra, es agua y, con el fuego, toma forma y vida.

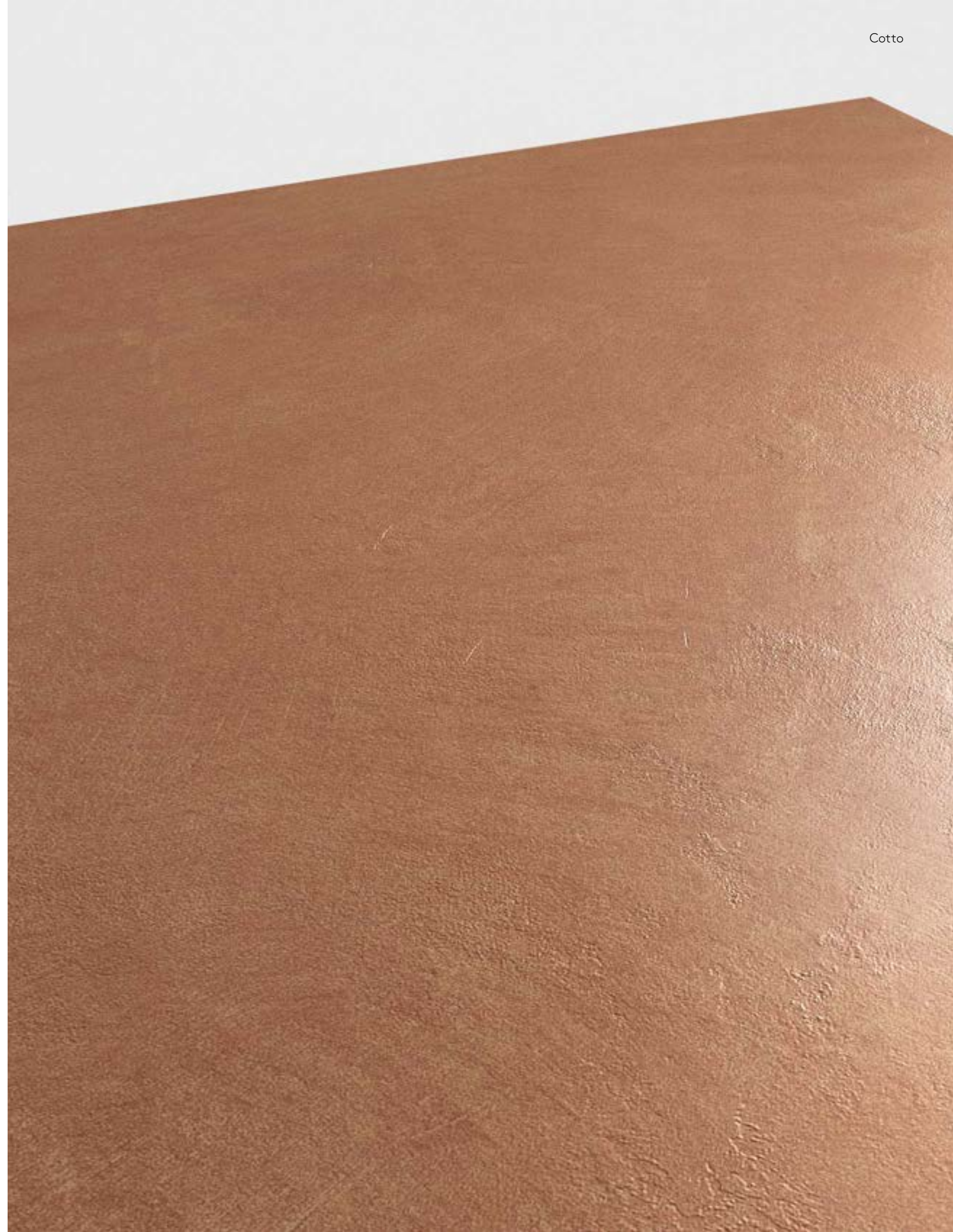

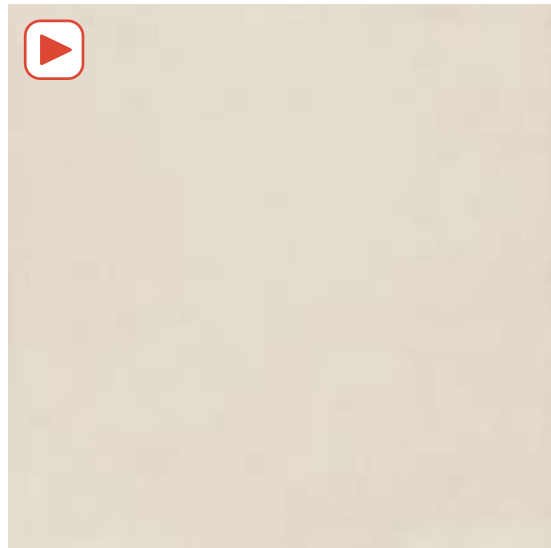

R10 ARGILLAE NEVE RECT.
120 X 120 / 48" X 48" **J74/M**

C3 R11 ANTI-SLIP ARGILLAE NEVE RECT.
120 X 120 / 48" X 48" **J99/M**



R10 ARGILLAE NEVE RECT.
60 X 120 / 24" X 48" **J72/M**

C3 R11 ANTI-SLIP ARGILLAE NEVE RECT.
60 X 120 / 24" X 48" **J73/M**

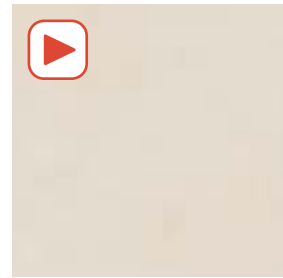

R10 ARGILLAE NEVE RECT.
60 X 60 / 24" X 24" **J70/M**

C3 R11 ANTI-SLIP ARGILLAE NEVE RECT.
60 X 60 / 24" X 24" **J71/M**

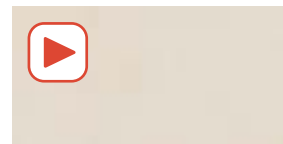

R10 ARGILLAE NEVE RECT.
30 X 60 / 12" X 24" **J70/M**

C3 R11 ANTI-SLIP ARGILLAE NEVE RECT.
30 X 60 / 12" X 24" **J71/M**

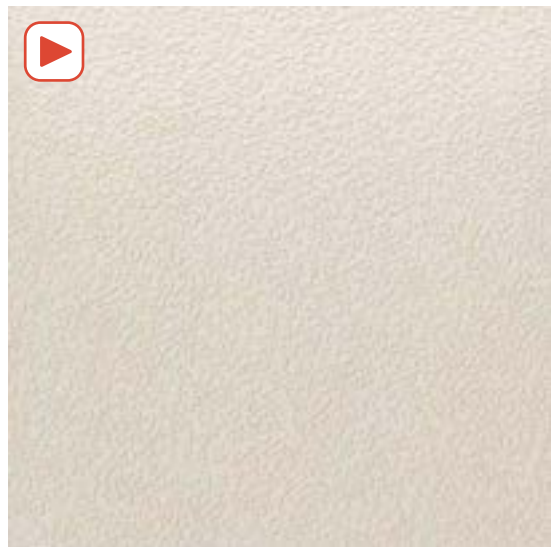

NISUS NEVE RECT.
120 X 120 / 48" X 48" **J75/M**



NISUS NEVE RECT.
60 X 120 / 24" X 48" **J75/M**

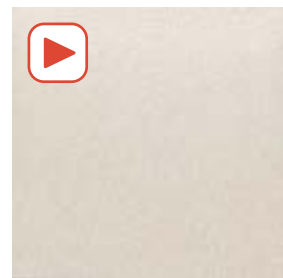

NISUS NEVE RECT.
60 X 60 / 24" X 24" **J75/M**

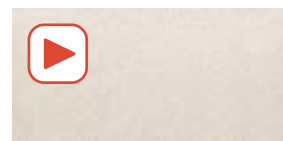

NISUS NEVE RECT.
30 X 60 / 12" X 24" **J75/M**

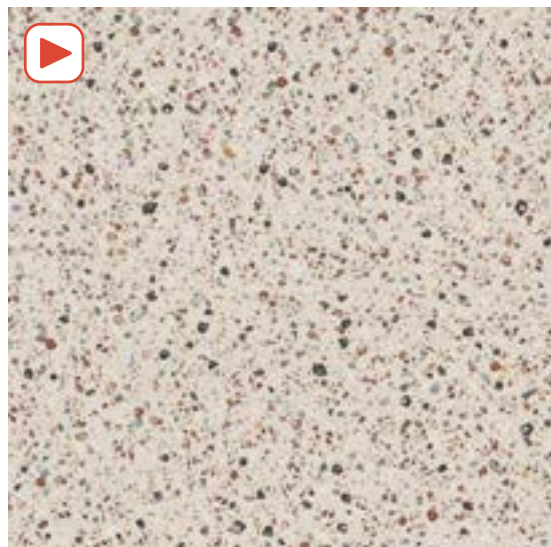

R10 COCCIO MIX RECT.
120 X 120 / 48" X 48" **J90/M**



***B V4** MURUS NIX
7 X 28 / 3" X 11" **J87/M**



R10 COCCIO MIX RECT.
60 X 60 / 24" X 24" **J78/M**



R10 COCCIO MIX RECT.
30 X 30 / 12" X 12" **J91/M**



ARGILLAE NEVE RECT. 60X120. COCCIO MIX RECT. 120X120.

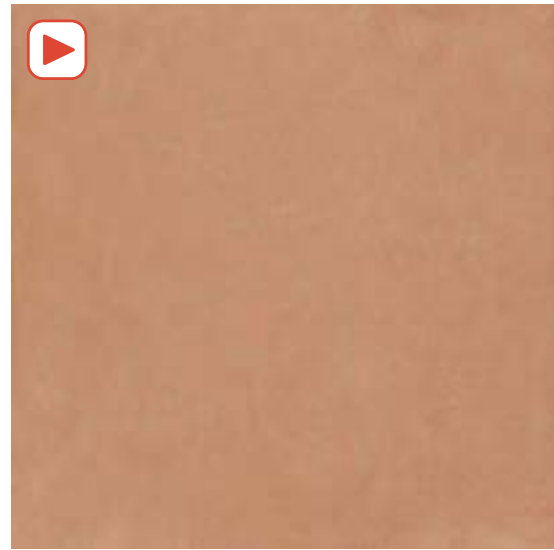

R10 ARGILLAE GOBI RECT.
120 X 120 / 48" X 48" **J74/M**

C3 R11 ANTI-SLIP ARGILLAE GOBI RECT.
120 X 120 / 48" X 48" **J99/M**



R10 ARGILLAE GOBI RECT.
60 X 120 / 24" X 48" **J72/M**

C3 R11 ANTI-SLIP ARGILLAE GOBI RECT.
60 X 120 / 24" X 48" **J73/M**

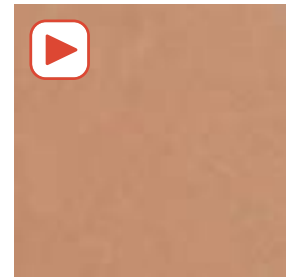

R10 ARGILLAE GOBI RECT.
60 X 60 / 24" X 24" **J70/M**

C3 R11 ANTI-SLIP ARGILLAE GOBI RECT.
60 X 60 / 24" X 24" **J71/M**

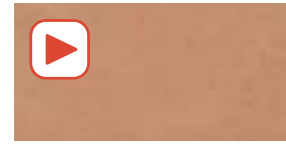

R10 ARGILLAE GOBI RECT.
30 X 60 / 12" X 24" **J70/M**

C3 R11 ANTI-SLIP ARGILLAE GOBI RECT.
30 X 60 / 12" X 24" **J71/M**



R10 NISUS GOBI RECT.
120 X 120 / 48" X 48" **J75/M**



R10 NISUS GOBI RECT.
60 X 120 / 24" X 48" **J75/M**

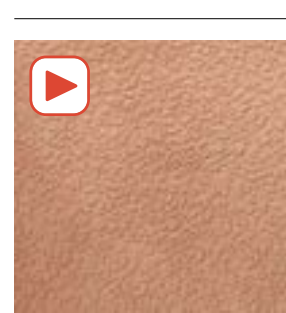

R10 NISUS GOBI RECT.
60 X 60 / 24" X 24" **J75/M**



R10 NISUS GOBI RECT.
30 X 60 / 12" X 24" **J75/M**

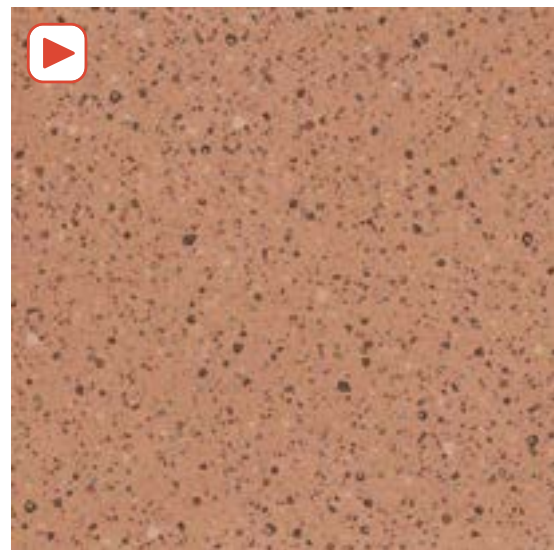

R10 COCCIO GOBI RECT.
120 X 120 / 48" X 48" **J90/M**

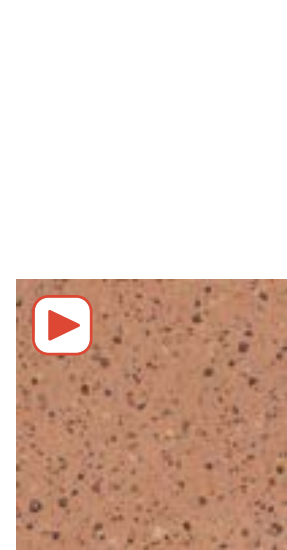

R10 COCCIO GOBI RECT.
60 X 60 / 24" X 24" **J78/M**



R10 COCCIO GOBI RECT.
30 X 30 / 12" X 12" **J91/M**

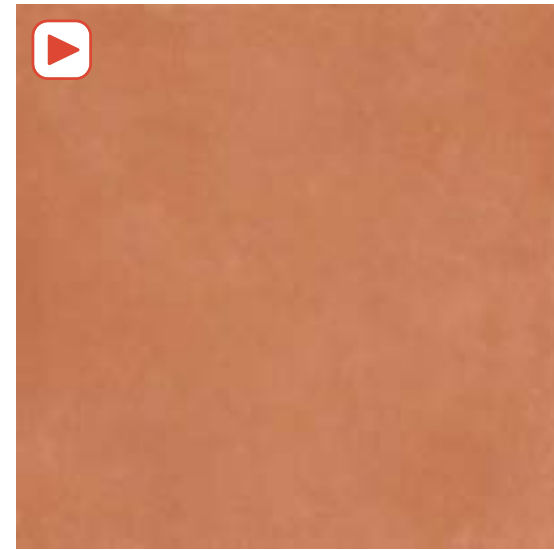

R10 ARGILLAE CORAL RECT.
120 X 120 / 48" X 48" **J74/M**

C3 R11 ANTI-SLIP ARGILLAE CORAL RECT.
120 X 120 / 48" X 48" **J99/M**



R10 ARGILLAE CORAL RECT.
60 X 120 / 24" X 48" **J72/M**

C3 R11 ANTI-SLIP ARGILLAE CORAL RECT.
60 X 120 / 24" X 48" **J73/M**

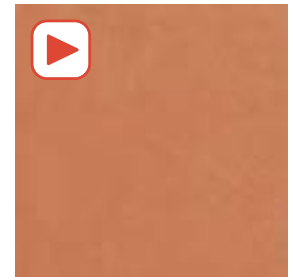

R10 ARGILLAE CORAL RECT.
60 X 60 / 24" X 24" **J70/M**

C3 R11 ANTI-SLIP ARGILLAE CORAL RECT.
60 X 60 / 24" X 24" **J71/M**



R10 ARGILLAE CORAL RECT.
30 X 60 / 12" X 24" **J70/M**

C3 R11 ANTI-SLIP ARGILLAE CORAL RECT.
30 X 60 / 12" X 24" **J71/M**

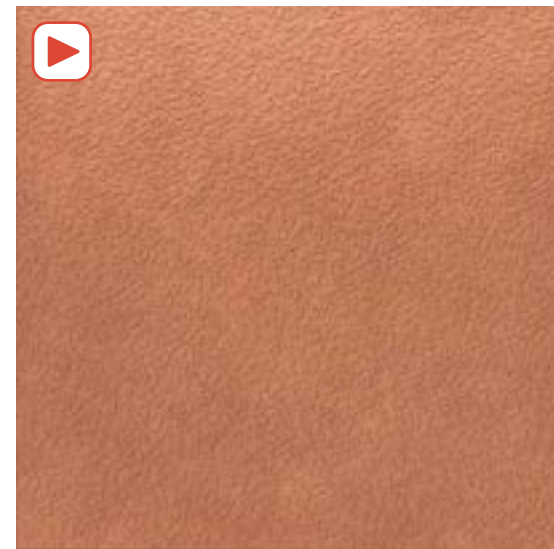

R10 NISUS CORAL RECT.
120 X 120 / 48" X 48" **J75/M**



R10 NISUS CORAL RECT.
60 X 120 / 24" X 48" **J75/M**



R10 NISUS CORAL RECT.
60 X 60 / 24" X 24" **J75/M**



R10 NISUS CORAL RECT.
30 X 60 / 12" X 24" **J75/M**

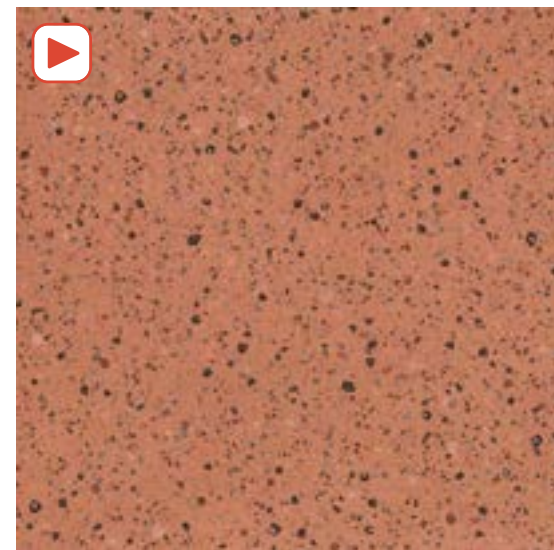

R10 COCCIO CORAL RECT.
120 X 120 / 48" X 48" **J90/M**



R10 COCCIO CORAL RECT.
60 X 60 / 24" X 24" **J78/M**



R10 COCCIO CORAL RECT.
30 X 30 / 12" X 12" **J91/M**

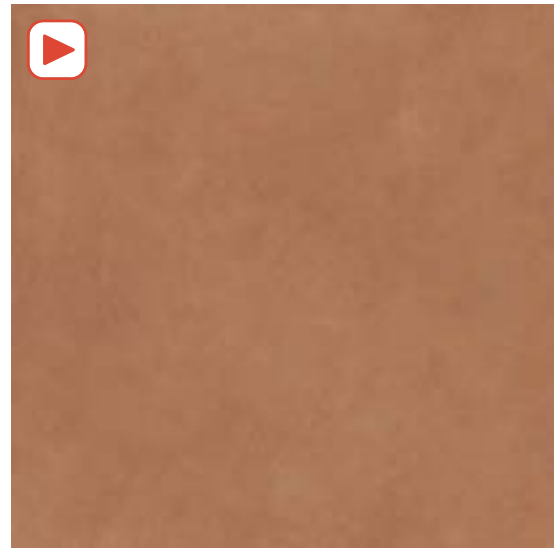

R10 ARGILLAE TERRA RECT.
120 X 120 / 48" X 48" J79/M

C3 R11 ANTI-SLIP ARGILLAE TERRA RECT.
120 X 120 / 48" X 48" J99/M



R10 ARGILLAE TERRA RECT.
60 X 120 / 24" X 48" J80/M

C3 R11 ANTI-SLIP ARGILLAE TERRA RECT.
60 X 120 / 24" X 48" J81/M

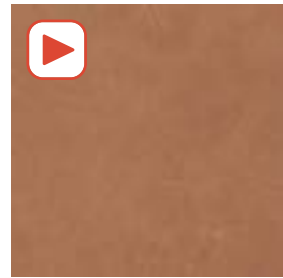

R10 ARGILLAE TERRA RECT.
60 X 60 / 24" X 24" J82/M

C3 R11 ANTI-SLIP ARGILLAE TERRA RECT.
60 X 60 / 24" X 24" J83/M



R10 ARGILLAE TERRA RECT.
30 X 60 / 12" X 24" J82/M

C3 R11 ANTI-SLIP ARGILLAE TERRA RECT.
30 X 60 / 12" X 24" J83/M



NISUS TERRA RECT.
120 X 120 / 48" X 48" J84/M



NISUS TERRA RECT.
60 X 120 / 24" X 48" J84/M

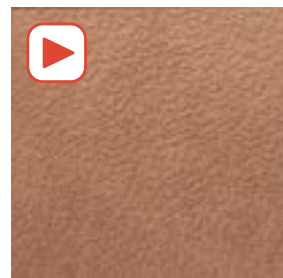

NISUS TERRA RECT.
60 X 60 / 24" X 24" J84/M



NISUS TERRA RECT.
30 X 60 / 12" X 24" J84/M

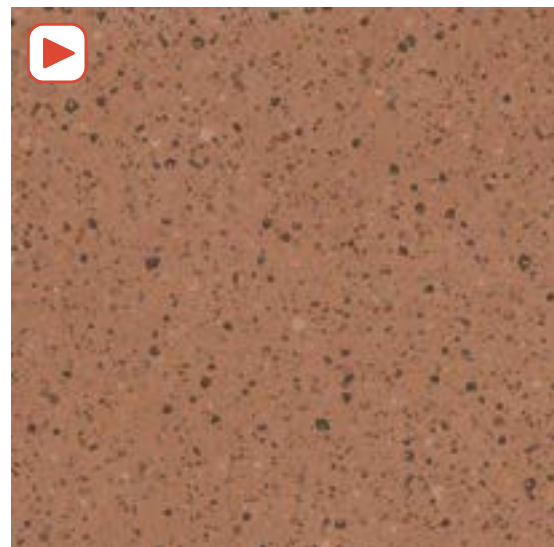

R10 COCCIO TERRA RECT.
120 X 120 / 48" X 48" J90/M



***B V4** MURUS TERRA
7 X 28 / 3" X 11" J87/M



R10 COCCIO TERRA RECT.
60 X 60 / 24" X 24" J78/M



R10 COCCIO TERRA RECT.
30 X 30 / 12" X 12" J91/M



ARGILLAE NEVE RECT. 120X120 / MURUS TERRA 7X28

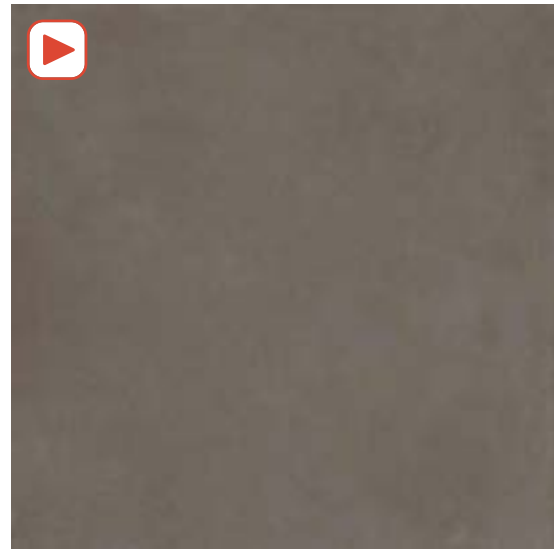

R10 ARGILLAE FUMO RECT.
120 X 120 / 48" X 48" **J74/M**

C3 R11 ANTI-SLIP ARGILLAE FUMO RECT.
120 X 120 / 48" X 48" **J99/M**



R10 ARGILLAE FUMO RECT.
60 X 120 / 24" X 48" **J72/M**

C3 R11 ANTI-SLIP ARGILLAE FUMO RECT.
60 X 120 / 24" X 48" **J73/M**

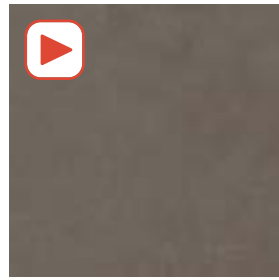

R10 ARGILLAE FUMO RECT.
60 X 60 / 24" X 24" **J70/M**

C3 R11 ANTI-SLIP ARGILLAE FUMO RECT.
60 X 60 / 24" X 24" **J71/M**



R10 ARGILLAE FUMO RECT.
30 X 60 / 12" X 24" **J70/M**

C3 R11 ANTI-SLIP ARGILLAE FUMO RECT.
30 X 60 / 12" X 24" **J71/M**

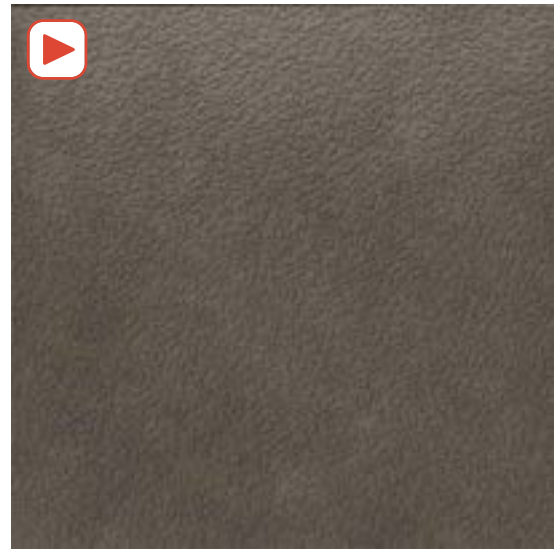

NISUS FUMO RECT.
120 X 120 / 48" X 48" **J75/M**



NISUS FUMO RECT.
60 X 120 / 24" X 48" **J75/M**

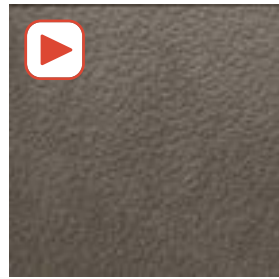

NISUS FUMO RECT.
60 X 60 / 24" X 24" **J75/M**



NISUS FUMO RECT.
30 X 60 / 12" X 24" **J75/M**



R10 COCCIO MIX RECT.
120 X 120 / 48" X 48" **J90/M**

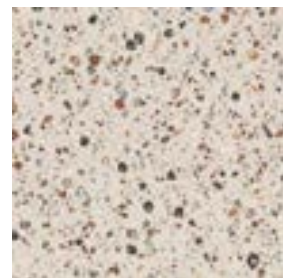

R10 COCCIO MIX RECT.
60 X 60 / 24" X 24" **J78/M**



R10 COCCIO MIX RECT.
30 X 30 / 12" X 12" **J91/M**

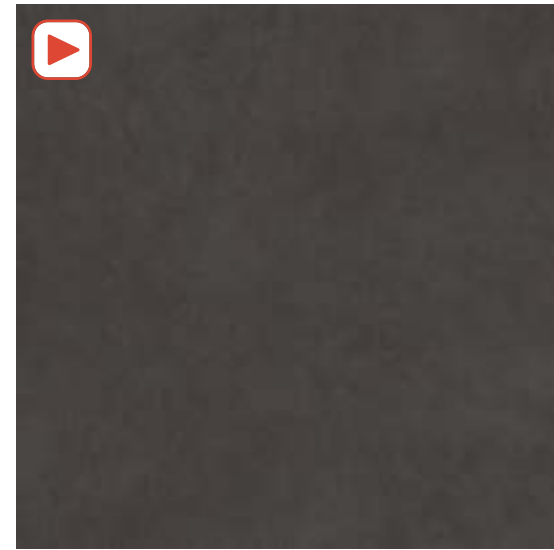

R10 ARGILLAE NOCTA RECT.
120 X 120 / 48" X 48" **J79/M**



R10 ARGILLAE NOCTA RECT.
60 X 120 / 24" X 48" **J80/M**

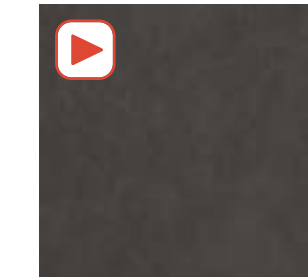

R10 ARGILLAE NOCTA RECT.
60 X 60 / 24" X 24" **J82/M**



R10 ARGILLAE NOCTA RECT.
30 X 60 / 12" X 24" **J82/M**

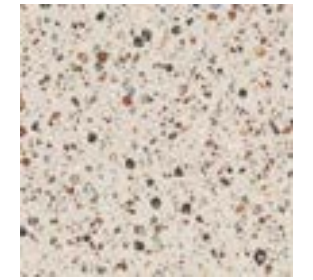

R10 COCCIO MIX RECT.
60 X 60 / 24" X 24" **J78/M**

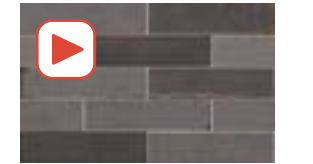

***B V4** MURUS NOCTA
7 X 28 / 3" X 11" **J87/M**

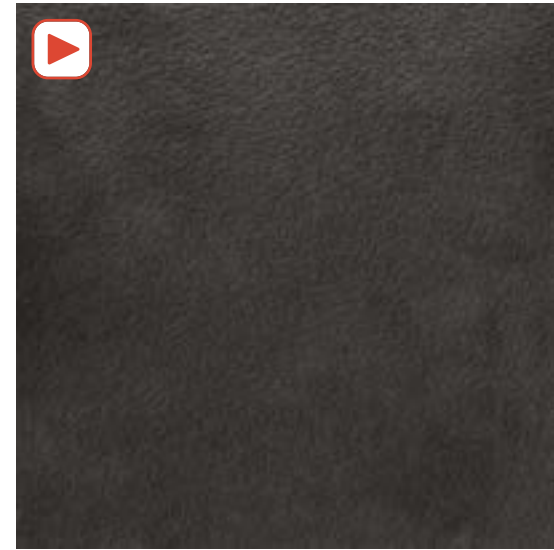

NISUS NOCTA RECT.
120 X 120 / 48" X 48" **J84/M**



NISUS NOCTA RECT.
60 X 120 / 24" X 48" **J84/M**

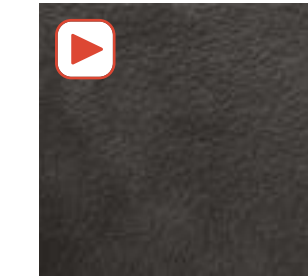

NISUS NOCTA RECT.
60 X 60 / 24" X 24" **J84/M**



NISUS NOCTA RECT.
30 X 60 / 12" X 24" **J84/M**

CARACTERÍSTICAS TÉCNICAS · TECHNICAL CHARACTERISTICS

- P** PORCELÁNICO / PORCELAIN TILES
GRÈS CERÁME / FEINSTEINZEUG
- M** MATE / MATT
MAT / MATT
- RE** RECTIFICADO / RECTIFIED
RECTIFIÉ / KALIBRIERT
- MA** MASA COLOREADA / COLORED BODY
TEINTÉE DANS LA MASSE / DURCHGEFÄRBT

- V2** VARIACION LEVE / SLIGHT VARIATION
LÉGERÉ VARIATION / LEICHT FARBSPIEL
- MOD** MODULARIDAD / MODULARITY
MODULARITÉ / MODULARITÄT
- AF** ANTIHIELO / FROST PROOF
RÉSISTANT AU GEL / FROSTSCHUTZ
- RU5** USO RECOMENDADO / RECOMMENDED USE - RU5

FORMATO SIZE FORMAT VERPACKUNG	PZS/CAJA TILES/BOX PIÈCES/BOITE	M ² /CAJA SQM/BOX MÈTRES/BOITE	KG/CAJA KG/BOX KG/BOITE	CAJAS/PALLET BOXES/PALLET BOITES/PALETTE	M ² /PALLET SQM/PALLETTE MÈTRES/PALETTE	KG/PALLET KG/PALLET MÈTRES/PALETTE
120X120	1	1.44	35.19	36	51.84	1267
60X120	2	1.44	34.33	36	51.84	1236
60X60	3	1.08	24.28	40	43.20	971
30X60	6	1.08	24.52	48	51.84	1177
30X30	10	0.90	19.67	48	43.20	944
7X28	50	0.98	17.63	52	50.96	917

Para más información técnica, especificaciones e imágenes visite nuestra web y busque: Argillae
El embalaje de los artículos está sujeto a variaciones, para obtener el dato exacto y actual se recomienda consultar la web.
For more technical information, specifications and images, visit our website and search: Argillae
The packing of our items is subject to variations. To get the most accurate and updated information, we recommend to check the website.
Pour plus d'informations techniques, de spécifications et de visuels, visitez notre site web et recherchez: Argillae
L'emballage des articles est sujet à variation, pour obtenir les données exactes et actuelles il est recommandé de consulter notre site web.

RODAPIÉS · SKIRTING BOARDS

DISPONIBLE EN TODOS LOS COLORES / AVAILABLE IN ALL COLORS



ROD. ARGILLAE
10 X 120 / 4" X 48" **K02/P**

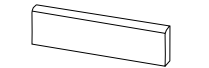

ROD. ARGILLAE
7.5 X 60 / 3" X 24" **K24/P**



ROD. COCCIO
10 X 120 / 4" X 48" **K02/P**



ROD. COCCIO
7.5 X 60 / 3" X 24" **K24/P**

Metal



We present a series of collections that take metals as a reference. From pieces inspired in weathered steel, to surfaces where a rusted effect with shiny and matte textures create a unique structure.

Presentamos una serie de colecciones que toman los metales como referencia. Desde piezas inspiradas en el acero corten, hasta superficies donde los efectos óxidos con brillos y mates, crean una estructura única.





STEEL WHITE POLISHED RECT
60 X 120 / 24" X 48"

J18/M



STEEL LIGHT POLISHED RECT
60 X 120 / 24" X 48"

J18/M



STEEL GREY POLISHED RECT
60 X 120 / 24" X 48"

J18/M



STEEL GOLD POLISHED RECT
60 X 120 / 24" X 48"

J18/M

RODAPIÉS · SKIRTING BOARDS



DISPONIBLE EN TODOS LOS COLORES / AVAILABLE IN ALL COLORS

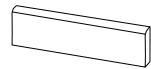

ROD. STEEL POL.
75 X 60 / 3" X 24" K29/P

VARIACIÓN DE DISEÑO · GRAPHIC FACES

60X120 - 12 PIEZAS/12 PIECES/12 PIÈCES

CARACTERÍSTICAS TÉCNICAS · TECHNICAL CHARACTERISTICS

- P** PORCELÁNICO / PORCELAIN TILES
GRÉS CERÁME / FEINSTEINZEUG
- V3** VARIACION MODERADA / MODERATE VARIATION
MODÉRÉE VARIATION / MITTLERES FARBSPIEL
- E** ESMALTE PULIDO / GLAZE POLISHED SHINY
ÉMAIL POLI BRILLANT / HOCHGLANZ POLIERT
- RU4** ANTIHIELO / FROST PROOF
RÉSISTANT AU GEL / FROSTSCHUTZ
- RU4** RECTIFICADO / RECTIFIED
RECTIFIÉ / KALIBRIERT
- RU4** USO RECOMENDADO / RECOMMENED USE - RU4

FORMATO SIZE FORMAT VERPACKUNG	PZS/CAJA TILES/BOX PIÈCES/BOITE	M²/CAJA SQM/BOX MÈTRES/BOITE	KG/CAJA KG/BOX KG/BOITE	CAJAS/PALLET BOXES/PALLET BOITES/PALETTE	M²/PALLET SQM/PALLET MÈTRES/PALETTE	KG/PALLET KG/PALLET MÈTRES/PALETTE
60X120	2	1.44	35.25	32	46.08	1128

Para más información técnica, especificaciones e imágenes visite nuestra web y busque: Steel
El embalaje de los artículos está sujeto a variaciones, para obtener el dato exacto y actual se recomienda consultar la web.

For more technical information, specifications and images, visit our website and search: Steel
The packing of our items is subject to variations. To get the most accurate and updated information, we recommend to check the website.

Pour plus d'informations techniques, de spécifications et de visuels, visitez notre site web et recherchez : Steel
L'emballage des articles est sujet à variation, pour obtenir les données exactes et actuelles il est recommandé de consulter notre site web.



STEEL GREY POLISHED RECT 60X120



DORIAN WHITE RECT
60 X 120 / 24" X 48" **R24/M**



DORIAN WHITE RECT.
60 X 60 / 24" X 24" **P87/M**



DORIAN WHITE RECT.
30 X 60 / 12" X 24" **P87/M**



DORIAN GRAPHITE RECT
60 X 120 / 24" X 48" **J23/M**



DORIAN GRAPHITE RECT.
60 X 60 / 24" X 24" **N45/M**



DORIAN GRAPHITE RECT.
30 X 60 / 12" X 24" **N45/M**



DORIAN BROWN RECT
60 X 120 / 24" X 48" **J23/M**



DORIAN BROWN RECT.
60 X 60 / 24" X 24" **N45/M**

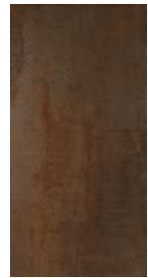

DORIAN BROWN RECT.
30 X 60 / 12" X 24" **N45/M**

RODAPIÉS · SKIRTING BOARDS



DISPONIBLE EN TODOS LOS COLORES / AVAILABLE IN ALL COLORS

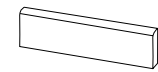

ROD. DORIAN
7.5 X 60 / 3" X 24" **K24/P**

VARIACIÓN DE DISEÑO · GRAPHIC FACES

60X120 -4 PIECES/4 PIECES/4 PIÈCES
60X60- 8 PIECES/8 PIECES/8 PIÈCES
30X60-12 PIECES/12 PIECES/12 PIÈCES

CARACTERÍSTICAS TÉCNICAS · TECHNICAL CHARACTERISTICS

- P** PORCELÁNICO/PORCELAIN TILES
GRÈS CERÁME/FEINSTEINZEUG
- M** MATE/MATT
MAT/MATT
- RECTIFICADO/RECTIFIED
RECTIFIÉ/KALIBRIERT
- MASA COLOREADA/COLORED BODY
TEINTÉE DANS LA MASSE/DURCHGEFÄRBT
- V3** VARIACION MODERADA/MODERATE VARIATION
MODÉRÉE VARIATION/MITTLERES FARBSPIEL
- ANTIHIELO/FROST PROOF
RÉSISTANT AU GEL/FROSTSCHUTZ
- RUS** USO RECOMENDADO/RECOMMENED USE - RU5

FORMATO SIZE FORMAT VERPACKUNG	PZS/CAJA TILES/BOX PIÈCES/BOITE	M²/CAJA SQM/BOX MÈTRES/BOITE	KG/CAJA KG/BOX KG/BOITE	CAJAS/PALLET BOXES/PALLET BOITES/PALETTE	M²/PALLET SQM/PALLET MÈTRES/PALETTE	KG/PALLET KG/PALLET MÈTRES/PALETTE
60X120	2	1.44	32.63	32	46.08	1044
60X60	4	1.44	30.20	30	43.20	906
30X60	7	1.26	25.13	40	50.40	1005

Para más información técnica, especificaciones e imágenes visite nuestra web y busque: Dorian
El embalaje de los artículos está sujeto a variaciones, para obtener el dato exacto y actual se recomienda consultar la web.
For more technical information, specifications and images, visit our website and search: Dorian
The packing of our items is subject to variations. To get the most accurate and updated information, we recommend to check the website.
Pour plus d'informations techniques, de spécifications et de visuels, visitez notre site web et recherchez : Dorian
L'emballage des articles est sujet à variation, pour obtenir les données exactes et actuelles il est recommandé de consulter notre site web.



OSSIDI WHITE
20 X 60 / 8" X 24" **R06/M**



DECOR SET(2) OSSIDI
20 X 60 / 8" X 24" **K59/P**



OSSIDI OXID
20 X 60 / 8" X 24" **R06/M**



OSSIDI MOSS
20 X 60 / 8" X 24" **R06/M**



OSSIDI OXID 20X60.

CARACTERÍSTICAS TÉCNICAS · TECHNICAL CHARACTERISTICS

- PR** PASTA ROJA/RED BODY
PÂTE ROUGE/ROTSCHERBIG
- BRILLO/SHINE
BRILLANT/GLÄNZEN
- REVESTIMIENTO/WALL TILE
FAÏENCE/WANDFLIESEN
- V3** VARIACION MODERADA/MODERATE VARIATION
MODÉRÉE VARIATION/MITTLERES FARBSPIEL

FORMATO SIZE FORMAT VERPACKUNG	PZS/CAJA TILES/BOX PIÈCES/BOITE	M²/CAJA SQM/BOX MÈTRES/BOITE	KG/CAJA KG/BOX KG/BOITE	CAJAS/PALLET BOXES/PALLET BOITES/PALETTE	M²/PALLET SQM/PALLET MÈTRES/PALETTE	KG/PALLET KG/PALLET MÈTRES/PALETTE
20X60	9	1.08	17.65	80	86.40	1412

Para más información técnica, especificaciones e imágenes visite nuestra web y busque: Ossidi
El embalaje de los artículos está sujeto a variaciones, para obtener el dato exacto y actual se recomienda consultar la web.
For more technical information, specifications and images, visit our website and search: Ossidi
The packing of our items is subject to variations. To get the most accurate and updated information, we recommend to check the website.
Pour plus d'informations techniques, de spécifications et de visuels, visitez notre site web et recherchez : Ossidi
L'emballage des articles est sujet à variation, pour obtenir les données exactes et actuelles il est recommandé de consulter notre site web.

Wood



Ceramic wood allows us to work in finishes and textures of real wood, but with the technical features of the most advanced ceramic. Our collections offer a large range of possibilities in types of wood, formats, colors and finishes. The collections are completed with options for outdoor spaces and swimming pools.

La madera cerámica permite trabajar acabados y texturas propias del material natural, pero con las características técnicas de la cerámica más avanzada. Nuestras colecciones ofrecen un amplio abanico de posibilidades, en tipos de madera, formatos, colores y acabados. Las colecciones se completan con opciones para exteriores y piscinas.

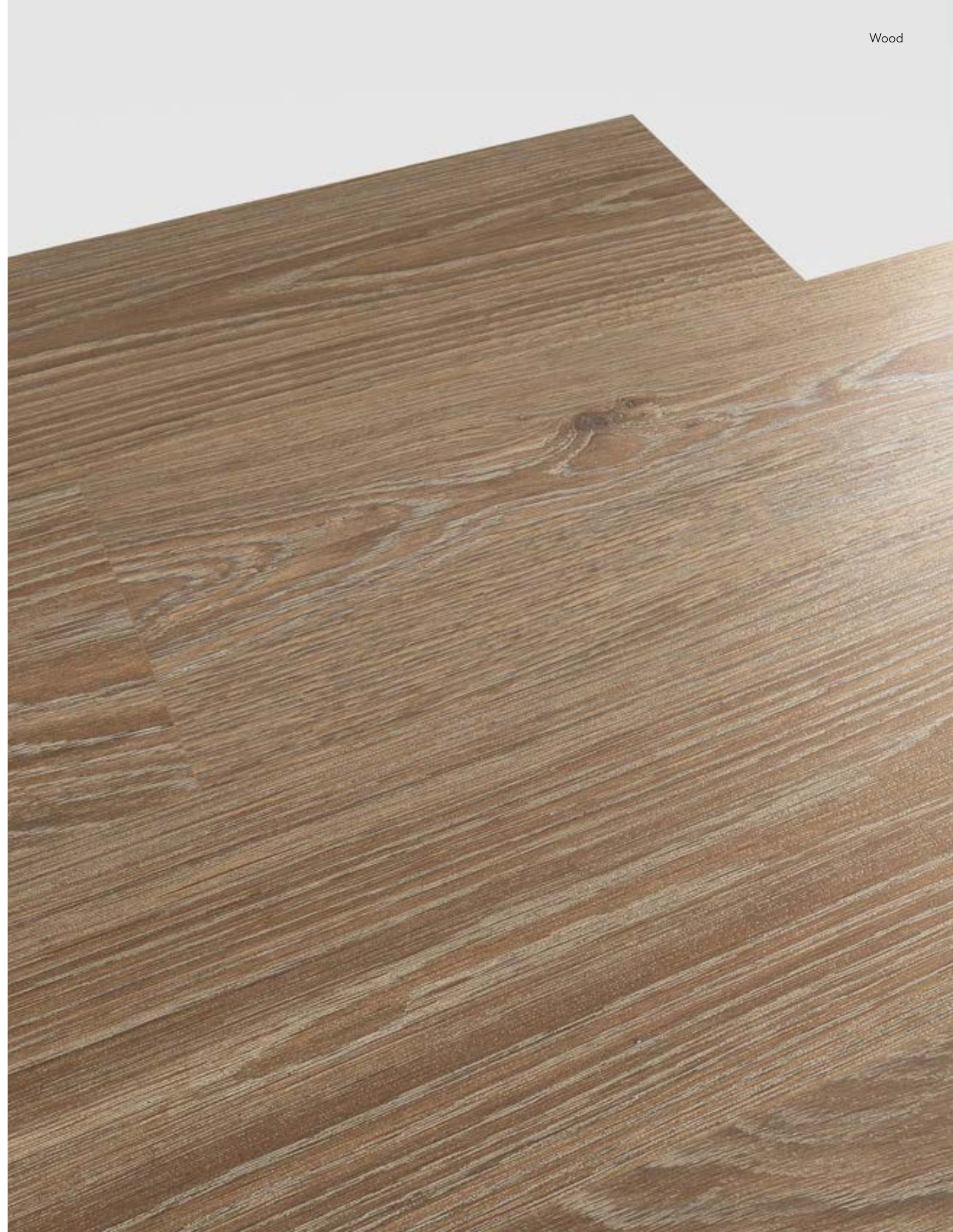



P **RU5** **☑** KOEN CARAMELLO MATT RECT. 30 X 120 / 12'' X 48'' **R52/M**



P **RU5** **☑** KOEN CARAMELLO MATT RECT. 20 X 120 / 8'' X 48'' **R52/M**

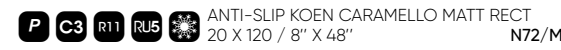

P **C3** **R11** **RU5** **☑** ANTI-SLIP KOEN CARAMELLO MATT RECT. 20 X 120 / 8'' X 48'' **N72/M**



P **RU5** **☑** KOEN MIELE MATT RECT. 30 X 120 / 12'' X 48'' **R52/M**



P **RU5** **☑** KOEN MIELE MATT RECT. 20 X 120 / 8'' X 48'' **R52/M**



P **C3** **R11** **RU5** **☑** ANTI-SLIP KOEN MIELE MATT RECT. 20 X 120 / 8'' X 48'' **N72/M**



P **RU5** **☑** KOEN NATURALE MATT RECT. 30 X 120 / 12'' X 48'' **R52/M**



P **RU5** **☑** KOEN NATURALE MATT RECT. 20 X 120 / 8'' X 48'' **R52/M**



P **RU5** **☑** KOEN CENERE MATT RECT. 20 X 120 / 8'' X 48'' **R52/M**



P **C3** **R11** **RU5** **☑** ANTI-SLIP KOEN CENERE MATT RECT. 20 X 120 / 8'' X 48'' **N72/M**



P **RU5** **☑** KOEN TABACCO MATT RECT. 20 X 120 / 8'' X 48'' **R52/M**



PB **☑** KI CARAMELLO RECT. 40 X 120 / 16'' X 48'' **R32/M**

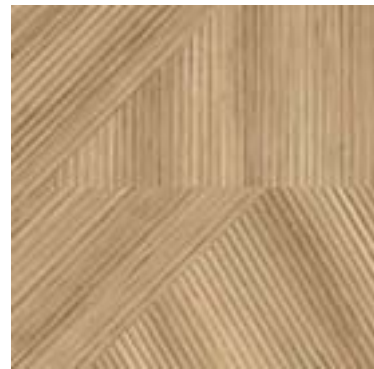

P **RU5** **☑** ZAIKU CARAMELLO MATT RECT. 80 X 80 / 32'' X 32'' **P44/M**



PB **☑** KI MIELE RECT. 40 X 120 / 16'' X 48'' **R32/M**

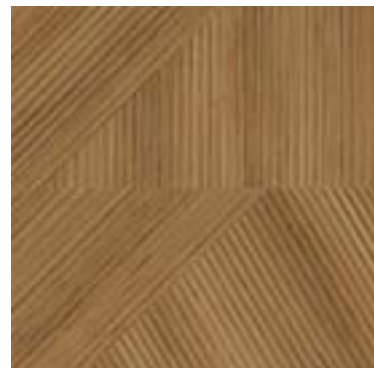

P **RU5** **☑** ZAIKU MIELE MATT RECT. 80 X 80 / 32'' X 32'' **P44/M**



PB **☑** KI NATURALE RECT. 40 X 120 / 16'' X 48'' **R32/M**



P **RU5** **☑** ZAIKU NATURALE MATT RECT. 80 X 80 / 32'' X 32'' **P44/M**



PB **☑** KI CENERE RECT. 40 X 120 / 16'' X 48'' **R32/M**



PELDAÑOS · STEPS **P** **M** **☑** **V3** **RU5** **☑**

DISPONIBLE EN TODOS LOS COLORES / AVAILABLE IN ALL COLORS
* DISPONIBLE EN / AVAILABLE IN: MIELE, CARAMELLO, CENERE

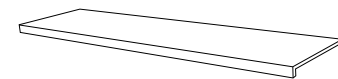

C3 **R11** PELDAÑO RECTO ANT. C3 KOEN 33 X 120 / 13'' X 48'' **K91/P**



REMATE PELD. RECTO KOEN 3.2 X 33 / 1.5'' X 13'' **K36/P**

R10 PELDAÑO RECTO C1 KOEN 33 X 120 / 13'' X 48'' **K91/P**

RODAPIÉS · SKIRTING BOARDS **P** **M** **☑** **V3** **☑**

DISPONIBLE EN TODOS LOS COLORES / AVAILABLE IN ALL COLORS
* DISPONIBLE EN / AVAILABLE IN: MIELE, CARAMELLO, CENERE

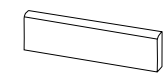

ROD. KOEN MATT 8 X 60 / 3'' X 24'' **K24/P**



TABICA KOEN 15 X 120 / 6'' X 48'' **K11/P**

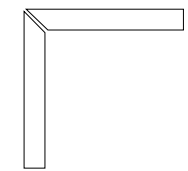

ZANQUIN RECTO KOEN MATT 8 X 60 / 3'' X 24'' **K09/P**

CARACTERÍSTICAS TÉCNICAS · TECHNICAL CHARACTERISTICS

M MATE/MATT MAT/MATT

V3 VARIACION MODERADA/MODERATE VARIATION MODÉRÉE VARIATION/MITTLERES FARBSPIEL

☑ RECTIFICADO/RECTIFIED RECTIFIÉ/KALIBRIERT

FORMATO SIZE FORMAT VERPACKUNG	PZS/CAJA TILES/BOX PIÈCES/BOITE	M²/CAJA SQM/BOX MÈTRES/BOITE	KG/CAJA KG/BOX KG/BOITE	CAJAS/PALLET BOXES/PALLET BOITES/PALETTE	M²/PALLET SQM/PALLET MÈTRES/PALETTE	KG/PALLET KG/PALLET MÈTRES/PALETTE
80X80	2	1.28	28.64	42	53.76	1203
40X120	3	1.44	24.30	20	28.80	486
30X120	3	1.06	21.45	40	42.40	858
20X120	5	1.20	24.73	45	54.00	1113

Para más información técnica, especificaciones e imágenes visite nuestra web y busque: Koen
El embalaje de los artículos está sujeto a variaciones, para obtener el dato exacto y actual se recomienda consultar la web.

For more technical information, specifications and images, visit our website and search: Koen
The packing of our items is subject to variations. To get the most accurate and updated information, we recommend to check the website.

Pour plus d'informations techniques, de spécifications et de visuels, visitez notre site web et recherchez: Koen
L'emballage des articles est sujet à variation, pour obtenir les données exactes et actuelles il est recommandé de consulter notre site web.



C2 R10 ALABAMA ARTICO RECT
20 X 120 / 8" X 48"

R53/M



C2 R10 ALABAMA QUERCIA RECT
20 X 120 / 8" X 48"

R53/M

C3 R11 ANTI-SLIP ALABAMA QUERCIA RECT
20 X 120 / 8" X 48"

N71/M



PB C3 R11 DECOWOOD WHITE MIX
25 X 29 / 10" X 11" R96/M



C2 R10 ALABAMA NEBBIA RECT
20 X 120 / 8" X 48"

R53/M



C2 R10 ALABAMA CENERE RECT
20 X 120 / 8" X 48"

R53/M

C3 R11 ANTI-SLIP ALABAMA NEBBIA RECT
20 X 120 / 8" X 48"

N71/M

C3 R11 ANTI-SLIP ALABAMA CENERE RECT
20 X 120 / 8" X 48"

N71/M



PB C3 R11 DECOWOOD SNOW MIX
25 X 29 / 10" X 11" R96/M



C2 R10 ALABAMA FAGGIO RECT
20 X 120 / 8" X 48"

R53/M



C2 R10 ALABAMA SANDALO RECT
20 X 120 / 8" X 48"

R53/M

C3 R11 ANTI-SLIP ALABAMA SANDALO RECT
20 X 120 / 8" X 48"

N71/M



PB C3 R11 DECOWOOD HAYA MIX
25 X 29 / 10" X 11" R96/M

CARACTERÍSTICAS TÉCNICAS · TECHNICAL CHARACTERISTICS

P PORCELÁNICO/PORCELAIN TILES
GRÉS CERÁMICO/FEINSTEINZEUG

V3 VARIACION MODERADA/MODERATE VARIATION
MODÉRÉE VARIATION/MITTLERES FARBSPIEL

M MATE/MATT
MAT/MATT

ANTIHIELO/FROST PROOF
RÉSISTANT AU GEL/FROSTSCHUTZ

RECTIFICADO/RECTIFIED
RECTIFIÉ/KALIBRIERT

RUS USO RECOMENDADO/RECOMMENED USE - RU5

FORMATO SIZE FORMAT VERPACKUNG	PZS/CAJA TILES/BOX PIÈCES/BOITE	M²/CAJA SQM/BOX MÈTRES/BOITE	KG/CAJA KG/BOX KG/BOITE	CAJAS/PALLET BOXES/PALLET BOITES/PALETTE	M²/PALLET SQM/PALLET MÈTRES/PALETTE	KG/PALLET KG/PALLET MÈTRES/PALETTE
25X29	18	1.00	22.35	48	48.00	1073
20X120	6	1.44	33.70	44	63.36	1483

Para más información técnica, especificaciones e imágenes visite nuestra web y busque: Alabama
El embalaje de los artículos está sujeto a variaciones, para obtener el dato exacto y actual se recomienda consultar la web.

For more technical information, specifications and images, visit our website and search: Alabama
The packing of our items is subject to variations. To get the most accurate and updated information, we recommend to check the website.

Pour plus d'informations techniques, de spécifications et de visuels, visitez notre site web et recherchez : Alabama
L'emballage des articles est sujet à variation, pour obtenir les données exactes et actuelles il est recommandé de consulter notre site web.



ANTI-SLIP ALABAMA QUERCIA RECT; 20X120; PELDAÑO RECTO ANT. C3 ALABAMA QUERCIA 33X120

RODAPIÉS · SKIRTING BOARDS

P M V3

DISPONIBLE EN TODOS LOS COLORES / AVAILABLE IN ALL COLORS

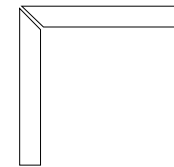

ZANQUIN RECTO ALABAMA
8 X 60 / 3" X 24" K09/P

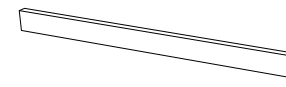

TABICA ALABAMA
15 X 120 / 6" X 48" K11/P

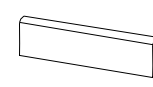

ROD. ALABAMA
8 X 60 / 3" X 24" K24/P

PELDAÑOS · STEPS

M V3 RU5

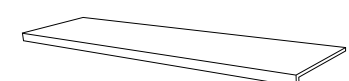

C3 R11 PELDAÑO RECTO ANT. C3 ALABAMA
33 X 120 / 13" X 48" K91/P

PELDAÑO RECTO C1 ALABAMA
33 X 120 / 13" X 48" K91/P



REMATE PELD. RECTO ALABAMA
3.2 X 33 / 1.5" X 13" K36/P



PELDAÑO RECTO ALABAMA

Apalache



APALACHE MIELE MATT RECT
20 X 120 / 8" X 48"

J10/M



APALACHE SABBIA MATT RECT
20 X 120 / 8" X 48"

J10/M



UMBER SABBIA
20 X 60 / 8" X 24" J12/M



APALACHE TABACCO MATT RECT
20 X 120 / 8" X 48"

J10/M



APALACHE SANDALO MATT RECT
20 X 120 / 8" X 48"

J10/M



UMBER SANDALO
20 X 60 / 8" X 24" J12/M



APALACHE GRIGIO MATT RECT
20 X 120 / 8" X 48"

J10/M



UMBER GRIGIO
20 X 60 / 8" X 24" J12/M



APALACHE MIELE MATT RECT 20X120.

RODAPÍÉS · SKIRTING BOARDS



DISPONIBLE EN TODOS LOS COLORES / AVAILABLE IN ALL COLORS



ROD. APALACHE
10 X 120 / 4" X 48" K02/P

CARACTERÍSTICAS TÉCNICAS · TECHNICAL CHARACTERISTICS

- M** MATE/MATT
MAT/MATT
- V2** VARIACION LEVE / SLIGHT VARIATION
LÉGERÉ VARIATION / LEICHT FARBSPIEL

FORMATO SIZE FORMAT VERPACKUNG	PZS/CAJA TILES/BOX PIÈCES/BOITE	M²/CAJA SQM/BOX MÈTRES/BOITE	KG/CAJA KG/BOX KG/BOITE	CAJAS/PALLET BOXES/PALLET BOITES/PALETTE	M²/PALLET SQM/PALLET MÈTRES/PALETTE	KG/PALLET KG/PALLET MÈTRES/PALETTE
20X120	7	1.68	33.66	44	73.92	1481
20X60	10	1.20	17.94	64	76.80	1148

Para más información técnica, especificaciones e imágenes visite nuestra web y busque: Apalache
El embalaje de los artículos está sujeto a variaciones, para obtener el dato exacto y actual se recomienda consultar la web.

For more technical information, specifications and images, visit our website and search: Apalache
The packing of our items is subject to variations. To get the most accurate and updated information, we recommend to check the website.

Pour plus d'informations techniques, de spécifications et de visuels, visitez notre site web et recherchez : Apalache
L'emballage des articles est sujet à variation, pour obtenir les données exactes et actuelles il est recommandé de consulter notre site web.



WORK W NATURAL RECT.
30 X 120 / 12" X 48"

P12/M

C3 R11 ANTI-SLIP WORK W NATURAL RECT.
30 X 120 / 12" X 48"

N24/M



WORK W NATURAL RECT.
20 X 120 / 8" X 48"

P12/M

C3 R11 ANTI-SLIP WORK W NATURAL RECT.
20 X 120 / 8" X 48"

N24/M

PELDAÑOS · STEPS

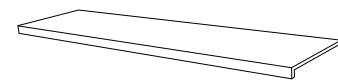

C3 R11 PELDAÑO RECTO ANT. C3 WORK W NATURAL
33 X 120 / 13" X 48" K91/P

PELDAÑO RECTO C1 WORK W NATURAL
33 X 120 / 13" X 48" K91/P



REMATE PELD. RECTO WORK W NATURAL
3.2 X 33 / 1.5" X 13" K36/P

RODAPÍÉS · SKIRTING BOARDS

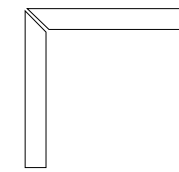

ZANQUIN RECTO WORK W NATURAL
10 X 60 / 4" X 24" K09/P



ROD. WORK W NATURAL
10 X 120 / 4" X 48" K02/P



TABICA WORK W NATURAL
15 X 120 / 6" X 48" K11/P

WORK W NATURAL RECT. 20X120/WORK B BIANCO RECT. 120X120



C2 R10 HEXAWORK W NATURAL
21 X 18.2 / 8" X 7" P03/M



C2 R10 V4 HEXAWORK MIX
21 X 18.2 / 8" X 7" N39/M



PELDAÑO RECTO WORK W NATURAL

CARACTERÍSTICAS TÉCNICAS · TECHNICAL CHARACTERISTICS

- P** PORCELÁNICO / PORCELAIN TILES
GRÈS CERÁME / FEINSTEINZEUG
- V2** VARIACION LEVE / SLIGHT VARIATION
LÉGERÉ VARIATION / LEICHT FARBSPIEL
- M** MATE / MATT
MAT / MATT
- RU5** USO RECOMENDADO / RECOMMENED USE - RU5
- ANTIHIELO / FROST PROOF**
RÉSISTANT AU GEL / FROSTSCHUTZ

FORMATO SIZE FORMAT VERPACKUNG	PZS/CAJA TILES/BOX PIÈCES/BOITE	M²/CAJA SQM/BOX MÈTRES/BOITE	KG/CAJA KG/BOX KG/BOITE	CAJAS/PALLET BOXES/PALLET BOITES/PALETTE	M²/PALLET SQM/PALLET MÈTRES/PALETTE	KG/PALLET KG/PALLET MÈTRES/PALETTE
30X120	3	1.08	24.33	48	51.84	1168
21X18,2	16	0.46	9.81	100	45.86	981
20X120	3	0.72	15.40	60	43.20	924

Para más información técnica, especificaciones e imágenes visite nuestra web y busque: Work
El embalaje de los artículos está sujeto a variaciones, para obtener el dato exacto y actual se recomienda consultar la web.

For more technical information, specifications and images, visit our website and search: Work
The packing of our items is subject to variations. To get the most accurate and updated information, we recommend to check the website.

Pour plus d'informations techniques, de spécifications et de visuels, visitez notre site web et recherchez : Work
L'emballage des articles est sujet à variation, pour obtenir les données exactes et actuelles il est recommandé de consulter notre site web.



QUEBEC GRIS RECT
20 X 120 / 8" X 48" R52/M

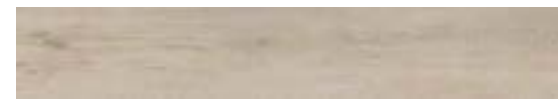

QUEBEC HAYA RECT
20 X 120 / 8" X 48" R52/M



QUEBEC NATURAL RECT
20 X 120 / 8" X 48" R52/M



QUEBEC NATURAL RECT 20X120.

RODAPIÉS · SKIRTING BOARDS **P M V2**

DISPONIBLE EN TODOS LOS COLORES / AVAILABLE IN ALL COLORS



ROD. QUEBEC
8 X 60 / 3" X 24" K24/P



TABICA QUEBEC
15 X 120 / 6" X 48" K11/P

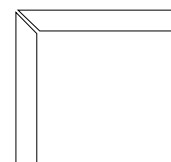

ZANQUIN RECTO QUEBEC
8 X 60 / 3" X 24" K09/P

PELDAÑOS · STEPS **M P V2 R10 R11 R15**

DISPONIBLE EN TODOS LOS COLORES / AVAILABLE IN ALL COLORS

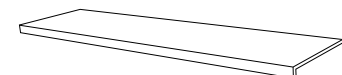

PELDAÑO RECTO ANT. C3 QUEBEC
33 X 120 / 13" X 48" K91/P



REMATE PELD. RECTO QUEBEC
3.2 X 33 / 1.5" X 13" K36/P

CARACTERÍSTICAS TÉCNICAS · TECHNICAL CHARACTERISTICS

- P** PORCELÁNICO/PORCELAIN TILES GRÉS CERÁME/FEINSTEINZEUG
- C2** CLASE 2/CLASS 2 CLASSE 2/CLASE 2
- ANTIHIELO/FROST PROOF** RÉSISTANT AU GEL/FROSTSCHUTZ
- M** MATE/MATT MAT/MATT
- R10** R10
- R15** USO RECOMENDADO/RECOMMENED USE - R15
- V2** RECTIFICADO/RECTIFIED RECTIFIÉ/KALIBRIERT
- V2** VARIACION LEVE/SLIGHT VARIATION LÉGERÉ VARIATION/LEICHT FARBSPIEL

FORMATO SIZE FORMAT VERPACKUNG	PZS/CAJA TILES/BOX PIÈCES/BOITE	M²/CAJA SQM/BOX MÈTRES/BOITE	KG/CAJA KG/BOX KG/BOITE	CAJAS/PALLET BOXES/PALLET BOITES/PALETTE	M²/PALLET SQM/PALLET MÈTRES/PALETTE	KG/PALLET KG/PALLET MÈTRES/PALETTE
20X120	4	0.96	19.20	48	46.08	922

Para más información técnica, especificaciones e imágenes visite nuestra web y busque: Quebec
El embalaje de los artículos está sujeto a variaciones, para obtener el dato exacto y actual se recomienda consultar la web.
For more technical information, specifications and images, visit our website and search: Quebec
The packing of our items is subject to variations. To get the most accurate and updated information, we recommend to check the website.
Pour plus d'informations techniques, de spécifications et de visuels, visitez notre site web et recherchez : Quebec
L'emballage des articles est sujet à variation, pour obtenir les données exactes et actuelles il est recommandé de consulter notre site web.



PROJECT WHITE RECT.
20 X 120 / 8" X 48" R52/M



PROJECT BLUE RECT.
20 X 120 / 8" X 48" R52/M



PROJECT GREY RECT.
20 X 120 / 8" X 48" R52/M



TIME WHITE POLISHED RECT
20 X 120 / 8" X 48" P53/M



TIME BLUE POLISHED RECT
20 X 120 / 8" X 48" P53/M



TIME GREY POLISHED RECT
20 X 120 / 8" X 48" P53/M



TIME BLUE RECT 20X120.

RODAPIÉS · SKIRTING BOARDS **V3**

DISPONIBLE EN TODOS LOS COLORES / AVAILABLE IN ALL COLORS



ROD. PROJECT
10 X 120 / 4" X 48" K02/P



ROD. TIME
10 X 120 / 4" X 48" K02/P

CARACTERÍSTICAS TÉCNICAS · TECHNICAL CHARACTERISTICS

- P** PORCELÁNICO/PORCELAIN TILES GRÉS CERÁME/FEINSTEINZEUG
- V3** VARIACION MODERADA/MODERATE VARIATION MODÉRÉE VARIATION/MITTLERES FARBSPIEL
- RECTIFICADO/RECTIFIED** RECTIFIÉ/KALIBRIERT
- ANTIHIELO/FROST PROOF** RÉSISTANT AU GEL/FROSTSCHUTZ

FORMATO SIZE FORMAT VERPACKUNG	PZS/CAJA TILES/BOX PIÈCES/BOITE	M²/CAJA SQM/BOX MÈTRES/BOITE	KG/CAJA KG/BOX KG/BOITE	CAJAS/PALLET BOXES/PALLET BOITES/PALETTE	M²/PALLET SQM/PALLET MÈTRES/PALETTE	KG/PALLET KG/PALLET MÈTRES/PALETTE
20X120	4	0.96	22.13	48	46.08	1062

Para más información técnica, especificaciones e imágenes visite nuestra web y busque: Project / Time
El embalaje de los artículos está sujeto a variaciones, para obtener el dato exacto y actual se recomienda consultar la web.
For more technical information, specifications and images, visit our website and search: Project / Time
The packing of our items is subject to variations. To get the most accurate and updated information, we recommend to check the website.
Pour plus d'informations techniques, de spécifications et de visuels, visitez notre site web et recherchez : Project / Time
L'emballage des articles est sujet à variation, pour obtenir les données exactes et actuelles il est recommandé de consulter notre site web.



C2 OREGON GRIS RECT
20 X 120 / 8" X 48" **R52/M**

C3 R11 ANTI-SLIP OREGON GRIS RECT
20 X 120 / 8" X 48" **N72/M**



C2 OREGON NOGAL RECT
20 X 120 / 8" X 48" **R52/M**

C3 R11 ANTI-SLIP OREGON NOGAL RECT
20 X 120 / 8" X 48" **N72/M**



C2 OREGON ROBLE RECT
20 X 120 / 8" X 48" **R52/M**

C3 R11 ANTI-SLIP OREGON ROBLE RECT
20 X 120 / 8" X 48" **N72/M**



C2 OREGON HAYA RECT
20 X 120 / 8" X 48" **R52/M**



C2 OREGON WENGUE RECT
20 X 120 / 8" X 48" **R52/M**

C2 OREGON WENGUE RECT
20 X 120 / 8" X 48" **R52/M**



C3 R10 CHEVRON OREGON GRIS A
9,8 X 46,5 / 4" X 21" **R74/M**

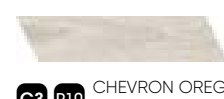

C3 R10 CHEVRON OREGON GRIS B
9,8 X 46,5 / 4" X 21" **R74/M**



C3 R10 CHEVRON OREGON NOGAL A
9,8 X 46,5 / 4" X 21" **R74/M**

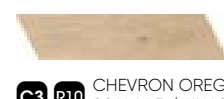

C3 R10 CHEVRON OREGON NOGAL B
9,8 X 46,5 / 4" X 21" **R74/M**

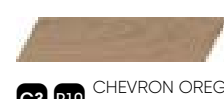

C3 R10 CHEVRON OREGON ROBLE A
9,8 X 46,5 / 4" X 21" **R74/M**

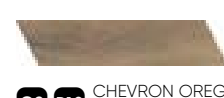

C3 R10 CHEVRON OREGON ROBLE B
9,8 X 46,5 / 4" X 21" **R74/M**

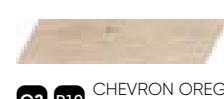

C3 R10 CHEVRON OREGON HAYA A
9,8 X 46,5 / 4" X 21" **R74/M**



C3 R10 CHEVRON OREGON HAYA B
9,8 X 46,5 / 4" X 21" **R74/M**



PB STEP GRIS RECT.
30 X 90 / 12" X 36" **N52/M**



PB STEP NOGAL RECT.
30 X 90 / 12" X 36" **N52/M**



PB STEP ROBLE RECT.
30 X 90 / 12" X 36" **N52/M**



PELDAÑOS · STEPS

* DISPONIBLE EN TODOS LOS COLORES / AVAILABLE IN ALL COLORS
**DISPONIBLE EN / AVAILABLE IN: GRIS / NOGAL / ROBLE

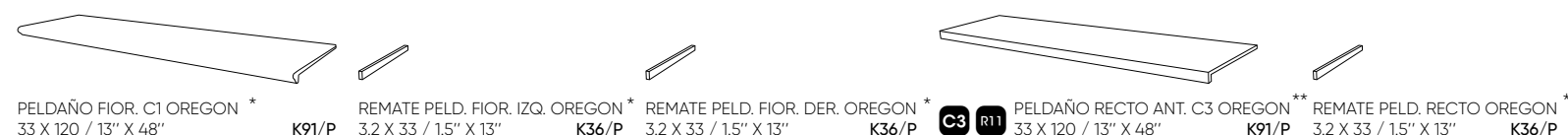

PELDAÑO FIOR. C1 OREGON * **K91/P** 33 X 120 / 13" X 48"
 REMATE PELD. FIOR. IZQ. OREGON * **K36/P** 3,2 X 33 / 1,5" X 13"
 REMATE PELD. FIOR. DER. OREGON * **K36/P** 3,2 X 33 / 1,5" X 13"
 PELDAÑO RECTO ANT. C3 OREGON ** **K91/P** 33 X 120 / 13" X 48"
 REMATE PELD. RECTO OREGON ** **K36/P** 3,2 X 33 / 1,5" X 13"

RODAPIÉS · SKIRTING BOARDS

* DISPONIBLE EN TODOS LOS COLORES / AVAILABLE IN ALL COLORS
**DISPONIBLE EN / AVAILABLE IN: GRIS / NOGAL / ROBLE

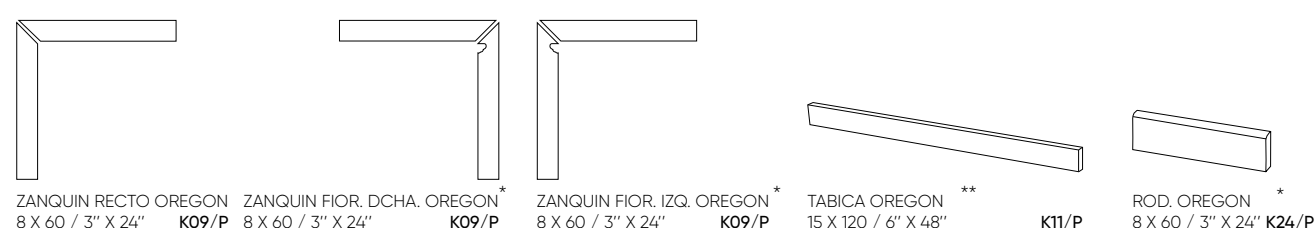

ZANQUIN RECTO OREGON **K09/P** 8 X 60 / 3" X 24"
 ZANQUIN FIOR. DCHA. OREGON * **K09/P** 8 X 60 / 3" X 24"
 ZANQUIN FIOR. IZQ. OREGON * **K09/P** 8 X 60 / 3" X 24"
 TABICA OREGON ** **K11/P** 15 X 120 / 6" X 48"
 ROD. OREGON * **K24/P** 8 X 60 / 3" X 24"



ANTI-SLIP OREGÓN NOGAL RECT 20X120.



PELDAÑO FIOR. OREGON



PELDAÑO RECTO ANT. OREGON

CARACTERÍSTICAS TÉCNICAS · TECHNICAL CHARACTERISTICS

- P** PORCELÁNICO / PORCELAIN TILES
GRÉS CERÁME / FEINSTEINZEUG
- M** MATE / MATT
MAT / MATT
- ANTIHIELO / FROST PROOF**
RÉSISTANT AU GEL / FROSTSCHUTZ
- PAVIMENTO / FLOOR TILES**
SOL / BODENFLIESEN
- V2** VARIACION LEVE / SLIGHT VARIATION
LÉGERÉ VARIATION / LEICHT FARBSPIEL
- RU5** USO RECOMENDADO / RECOMMENED USE - RU5

FORMATO SIZE FORMAT VERPACKUNG	PZS/CAJA TILES/BOX PIÈCES/BOITE	M ² /CAJA SQM/BOX MÈTRES/BOITE	KG/CAJA KG/BOX KG/BOITE	CAJAS/PALLET BOXES/PALLET BOITES/PALETTE	M ² /PALLET SQM/PALLET MÈTRES/PALETTE	KG/PALLET KG/PALLET MÈTRES/PALETTE
30X90	4	1.08	18.06	48	51.84	867
20X120	4	0.96	22.88	48	46.08	1098
9,8X46,5	10	0.46	9.26	112	51.07	1037

Para más información técnica, especificaciones e imágenes visite nuestra web y busque: Oregon
 El embalaje de los artículos está sujeto a variaciones, para obtener el dato exacto y actual se recomienda consultar la web.
 For more technical information, specifications and images, visit our website and search: Oregon
 The packing of our items is subject to variations. To get the most accurate and updated information, we recommend to check the website.
 Pour plus d'informations techniques, de spécifications et de visuels, visitez notre site web et recherchez: Oregon
 L'emballage des articles est sujet à variation, pour obtenir les données exactes et actuelles il est recommandé de consulter notre site web.



TRIANA HAYA RECT
20 X 120 / 8" X 48" **R52/M**

C3 R11 ANTI-SLIP TRIANA HAYA RECT
20 X 120 / 8" X 48" **N72/M**



TRIANA DESIERTO RECT
20 X 120 / 8" X 48" **R52/M**

C3 R11 ANTI-SLIP TRIANA DESIERTO RECT
20 X 120 / 8" X 48" **N72/M**



TRIANA CAOBA RECT
20 X 120 / 8" X 48" **R52/M**

C3 R11 ANTI-SLIP TRIANA CAOBA RECT
20 X 120 / 8" X 48" **N72/M**



TRIANA CANELA RECT
20 X 120 / 8" X 48" **R52/M**



TRIANA PERLA RECT
20 X 120 / 8" X 48" **R52/M**

C3 R11 ANTI-SLIP TRIANA PERLA RECT
20 X 120 / 8" X 48" **N72/M**



TRIANA CENIZA RECT
20 X 120 / 8" X 48" **R52/M**

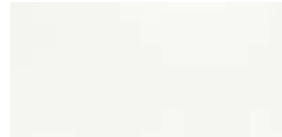

PB **V1** ALL WHITE MATT RECT.
30 X 60 / 12" X 24" **R70/M**



PB **V1** ALL WHITE SHINE RECT.
30 X 60 / 12" X 24" **R70/M**

VARIACIÓN DE DISEÑO · GRAPHIC FACES

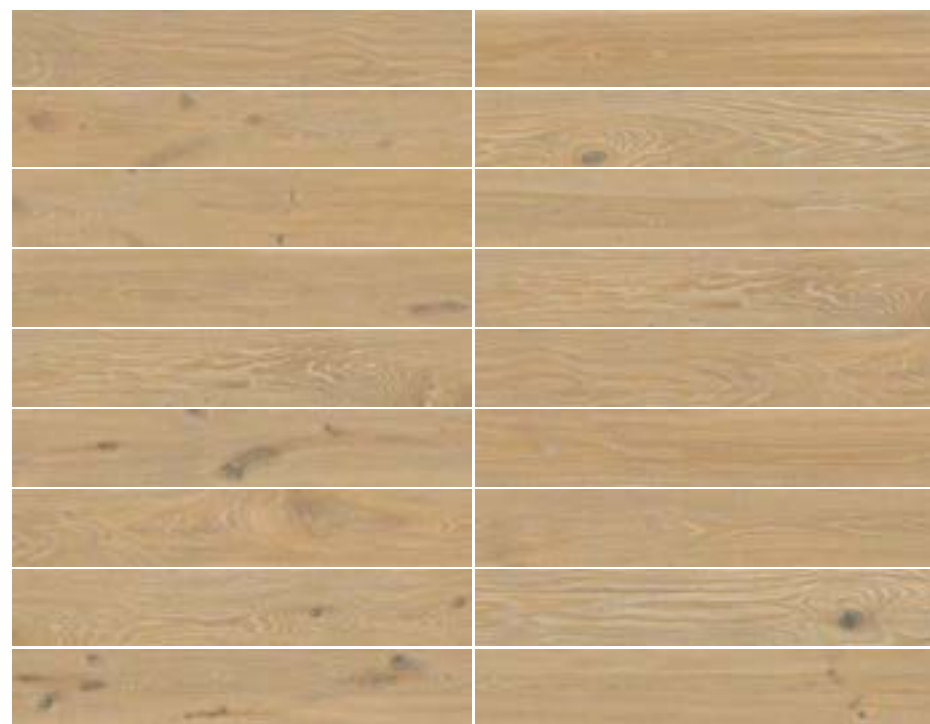

20X120 - 18 PIEZAS/18 PIÈCES/18 PIÈCES

CARACTERÍSTICAS TÉCNICAS · TECHNICAL CHARACTERISTICS

P PORCELÁNICO / PORCELAIN TILES
GRÉS CERÁME / FEINSTEINZEUG

M MATE / MATT
MAT / MATT

V3 VARIACION MODERADA / MODERATE VARIATION
MODÉÉE VARIATION / MITTLERES FARBSPIEL

U PAVIMENTO / FLOOR TILES
SOL / BODENFLIESEN

R RECTIFICADO / RECTIFIED
RECTIFIÉ / KALIBRIERT

S ANTIHIELO / FROST PROOF
RÉSISTANT AU GEL / FROSTSCHUTZ

RU5 USO RECOMENDADO / RECOMMENED USE - RU5

FORMATO SIZE FORMAT VERPACKUNG	PZS/CAJA TILES/BOX PIÈCES/BOITE	M²/CAJA SQM/BOX MÈTRES/BOITE	KG/CAJA KG/BOX KG/BOITE	CAJAS/PALLET BOXES/PALLET BOITES/PALETTE	M²/PALLET SQM/PALLET MÈTRES/PALETTE	KG/PALLET KG/PALLET MÈTRES/PALETTE
30X60	6	1.08	16.86	40	43.20	674
20X120	4	0.96	20.27	48	46.08	973

Para más información técnica, especificaciones e imágenes visite nuestra web y busque: Triana
El embalaje de los artículos está sujeto a variaciones, para obtener el dato exacto y actual se recomienda consultar la web.

For more technical information, specifications and images, visit our website and search: Triana
The packing of our items is subject to variations. To get the most accurate and updated information, we recommend to check the website.

Pour plus d'informations techniques, de spécifications et de visuels, visitez notre site web et recherchez : Triana
L'emballage des articles est sujet à variation, pour obtenir les données exactes et actuelles il est recommandé de consulter notre site web.



AMAZONITE POL RECT 60X120, SAP MATT RECT. 60X120, TRIANA CAOBA RECT. 20X120.

PELDAÑOS · STEPS **U M V3 RU5 S**

* DISPONIBLE EN TODOS LOS COLORES / AVAILABLE IN ALL COLORS
** DISPONIBLE EN / AVAILABLE IN: HAYA - DESIERTO - CAOBA - PERLA

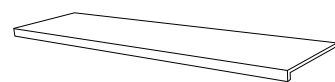

C3 R11 PELDAÑO RECTO ANT. C3 TRIANA **
33 X 120 / 13" X 48" **K91/P**

PELDAÑO RECTO C1 TRIANA *
33 X 120 / 13" X 48" **K91/P**

RODAPÍES · SKIRTING BOARDS **P M V3 S**

DISPONIBLE EN TODOS LOS COLORES / AVAILABLE IN ALL COLORS

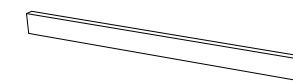

TABICA TRIANA
15 X 120 / 6" X 48" **K11/P**



ROD. TRIANA
10 X 120 / 4" X 48" **K02/P**

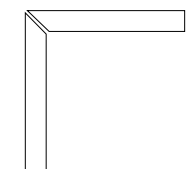

ZANQUIN RECTO TRIANA
10 X 60 / 4" X 24" **K09/P**



V3 MADAGASCAR BIANCO RECT.
20 X 120 / 8" X 48" **R52/M**



V3 MADAGASCAR SABBIA RECT.
20 X 120 / 8" X 48" **R52/M**



V3 MADAGASCAR TAUPE RECT.
20 X 120 / 8" X 48" **R52/M**



V3 MADAGASCAR GRAFITE RECT.
20 X 120 / 8" X 48" **R52/M**



V3 MADAGASCAR NOCE RECT.
20 X 120 / 8" X 48" **R52/M**

C3 R11 V3 ANTI-SLIP MADAGASCAR NOCE RECT.
20 X 120 / 8" X 48" **N72/M**



V3 SABI BIANCO RECT.
75 X 75 / 30" X 30" **N47/M**



V3 SABI SABBIA RECT.
75 X 75 / 30" X 30" **N47/M**



V3 SABI NOCE RECT.
75 X 75 / 30" X 30" **N47/M**



V3 SABI TAUPE RECT.
75 X 75 / 30" X 30" **N47/M**



V3 SABI GRAFITE RECT.
75 X 75 / 30" X 30" **N47/M**



MACCHIATO SABBIA RECT. 20X120. MACCHIATO TAUPE RECT. 20X120. STRU WABI TAUPE RECT. 60X120



PELDAÑOS · STEPS **M** **V3** **RU5**

* DISPONIBLE EN NOCE / AVAILABLE IN NOCE
** DISPONIBLE EN TODOS LOS COLORES / AVAILABLE IN ALL COLORS



C3 R11 PELDAÑO RECTO ANT. C3 MADAGASCAR *
33 X 120 / 13" X 48" **K91/P**



REMATE PELD. RECTO MADAGASCAR *
3.2 X 33 / 1.5" X 13" **K36/P**

RODAPIÉS · SKIRTING BOARDS **P** **M** **V3**

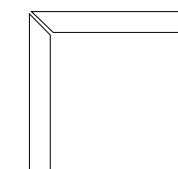

ZANQUIN RECTO MADAGASCAR *
10 X 60 / 4" X 24" **K09/P**



TABICA MADAGASCAR *
15 X 120 / 6" X 48" **K11/P**



ROD. MACCHIATO **
10 X 120 / 4" X 48" **K02/P**

ROD. MADAGASCAR **
10 X 120 / 4" X 48" **K02/P**

CARACTERÍSTICAS TÉCNICAS · TECHNICAL CHARACTERISTICS

P PORCELÁNICO/PORCELAIN TILES
GRÉS CERÁME/FEINSTEINZEUG

ANTIHIELO/FROST PROOF
RÉSISTANT AU GEL/FROSTSCHUTZ

M MATE/MATT
MAT/MATT

RU5 USO RECOMENDADO/RECOMMENED USE - RU5

RECTIFICADO/RECTIFIED
RECTIFIÉ/KALIBRIERT

FORMATO SIZE FORMAT VERPACKUNG	PZS/CAJA TILES/BOX PIÈCES/BOITE	M²/CAJA SQM/BOX MÈTRES/BOITE	KG/CAJA KG/BOX KG/BOITE	CAJAS/PALLET BOXES/PALLET BOITES/PALETTE	M²/PALLET SQM/PALLET MÈTRES/PALETTE	KG/PALLET KG/PALLET MÈTRES/PALETTE
75X75	2	1.13	26.84	48	54.24	1289
20X120	5	1.20	24.84	45	54.00	1118

Para más información técnica, especificaciones e imágenes visite nuestra web y busque: Wabi sabi

El embalaje de los artículos está sujeto a variaciones, para obtener el dato exacto y actual se recomienda consultar la web.

For more technical information, specifications and images, visit our website and search: Wabi sabi

The packing of our items is subject to variations. To get the most accurate and updated information, we recommend to check the website.

Pour plus d'informations techniques, de spécifications et de visuels, visitez notre site web et recherchez: Wabi sabi

L'emballage des articles est sujet à variation, pour obtenir les données exactes et actuelles il est recommandé de consulter notre site web.

Havana



HAVANA ALMOND
22.5 X 90 / 9" X 36" R92/M



HAVANA WALNUT
22.5 X 90 / 9" X 36" R92/M



HAVANA COFFEE
22.5 X 90 / 9" X 36" R92/M



HAVANA ASH
22.5 X 90 / 9" X 36" R92/M

RODAPIÉS · SKIRTING BOARDS



DISPONIBLE EN TODOS LOS COLORES / AVAILABLE IN ALL COLORS



ROD. HAVANA
7.5 X 90 / 3" X 36" K14/P



HAVANA WALNUT 22,5X90

CARACTERÍSTICAS TÉCNICAS · TECHNICAL CHARACTERISTICS

- P** PORCELÁNICO/PORCELAIN TILES
GRÈS CERÁME/FEINSTEINZEUG
- M** MATE/MATT
MAT/MATT
- V3** VARIACION MODERADA/MODERATE VARIATION
MODÉRÉE VARIATION/MITTLERES FARBSPIEL
- Frost** ANTIHIELO/FROST PROOF
RÉSISTANT AU GEL/FROSTSCHUTZ
- RUS** USO RECOMENDADO/RECOMMENED USE - RUS

FORMATO SIZE FORMAT VERPACKUNG	PZS/CAJA TILES/BOX PIÈCES/BOITE	M²/CAJA SQM/BOX MÈTRES/BOITE	KG/CAJA KG/BOX KG/BOITE	CAJAS/PALLET BOXES/PALLET BOITES/PALETTE	M²/PALLET SQM/PALLET MÈTRES/PALETTE	KG/PALLET KG/PALLET MÈTRES/PALETTE
22,5X90	6	1.22	22.85	60	72.90	1371

Para más información técnica, especificaciones e imágenes visite nuestra web y busque: Havana
El embalaje de los artículos está sujeto a variaciones, para obtener el dato exacto y actual se recomienda consultar la web.

For more technical information, specifications and images, visit our website and search: Havana
The packing of our items is subject to variations. To get the most accurate and updated information, we recommend to check the website.

Pour plus d'informations techniques, de spécifications et de visuels, visitez notre site web et recherchez : Havana
L'emballage des articles est sujet à variation, pour obtenir les données exactes et actuelles il est recommandé de consulter notre site web.

Giza

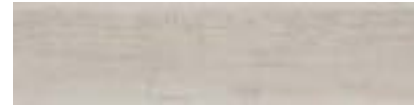

GIZA GRIS
22.5 X 90 / 9" X 36" R92/M



GIZA QUERCIA
22.5 X 90 / 9" X 36" R92/M



GIZA ROBLE
22.5 X 90 / 9" X 36" R92/M

CARACTERÍSTICAS TÉCNICAS · TECHNICAL CHARACTERISTICS

- P** PORCELÁNICO/PORCELAIN TILES
GRÈS CERÁME/FEINSTEINZEUG
- M** MATE/MATT
MAT/MATT
- V3** VARIACION MODERADA/MODERATE VARIATION
MODÉRÉE VARIATION/MITTLERES FARBSPIEL
- Frost** ANTIHIELO/FROST PROOF
RÉSISTANT AU GEL/FROSTSCHUTZ
- RUS** USO RECOMENDADO/RECOMMENED USE - RUS

RODAPIÉS · SKIRTING BOARDS



DISPONIBLE EN TODOS LOS COLORES / AVAILABLE IN ALL COLORS



ROD. GIZA
7.5 X 90 / 3" X 36" K14/P

FORMATO SIZE FORMAT VERPACKUNG	PZS/CAJA TILES/BOX PIÈCES/BOITE	M²/CAJA SQM/BOX MÈTRES/BOITE	KG/CAJA KG/BOX KG/BOITE	CAJAS/PALLET BOXES/PALLET BOITES/PALETTE	M²/PALLET SQM/PALLET MÈTRES/PALETTE	KG/PALLET KG/PALLET MÈTRES/PALETTE
22,5X90	6	1.22	23.28	60	72.90	1397

Para más información técnica, especificaciones e imágenes visite nuestra web y busque: Giza
El embalaje de los artículos está sujeto a variaciones, para obtener el dato exacto y actual se recomienda consultar la web.

For more technical information, specifications and images, visit our website and search: Giza
The packing of our items is subject to variations. To get the most accurate and updated information, we recommend to check the website.

Pour plus d'informations techniques, de spécifications et de visuels, visitez notre site web et recherchez : Giza
L'emballage des articles est sujet à variation, pour obtenir les données exactes et actuelles il est recommandé de consulter notre site web.



Luxor



LUXOR ARIA
22.5 X 90 / 9" X 36" R92/M



LUXOR GRIGIO
22.5 X 90 / 9" X 36" R92/M



LUXOR PAGLIA
22.5 X 90 / 9" X 36" R92/M



LUXOR FUOCO
22.5 X 90 / 9" X 36" R92/M



LUXOR CARBONE
22.5 X 90 / 9" X 36" R92/M

CARACTERÍSTICAS TÉCNICAS · TECHNICAL CHARACTERISTICS

- P** PORCELÁNICO/PORCELAIN TILES
GRÈS CERÁME/FEINSTEINZEUG
- M** MATE/MATT
MAT/MATT
- V2** VARIACION LEVE/SLIGHT VARIATION
LÉGERÉ VARIATION/LEICHT FARBSPIEL
- Frost** ANTIHIELO/FROST PROOF
RÉSISTANT AU GEL/FROSTSCHUTZ
- RUS** USO RECOMENDADO/RECOMMENED USE - RUS

RODAPIÉS · SKIRTING BOARDS



DISPONIBLE EN TODOS LOS COLORES / AVAILABLE IN ALL COLORS



ROD. LUXOR
7.5 X 90 / 3" X 36" K14/P

FORMATO SIZE FORMAT VERPACKUNG	PZS/CAJA TILES/BOX PIÈCES/BOITE	M²/CAJA SQM/BOX MÈTRES/BOITE	KG/CAJA KG/BOX KG/BOITE	CAJAS/PALLET BOXES/PALLET BOITES/PALETTE	M²/PALLET SQM/PALLET MÈTRES/PALETTE	KG/PALLET KG/PALLET MÈTRES/PALETTE
22,5X90	6	1.22	22.50	60	72.90	1350

Para más información técnica, especificaciones e imágenes visite nuestra web y busque: Luxor
El embalaje de los artículos está sujeto a variaciones, para obtener el dato exacto y actual se recomienda consultar la web.

For more technical information, specifications and images, visit our website and search: Luxor
The packing of our items is subject to variations. To get the most accurate and updated information, we recommend to check the website.

Pour plus d'informations techniques, de spécifications et de visuels, visitez notre site web et recherchez : Luxor
L'emballage des articles est sujet à variation, pour obtenir les données exactes et actuelles il est recommandé de consulter notre site web.

Marble



Thanks to the latest innovations in digital technology in pigments and glazes, we have been able to recreate the unique personality of marble on a ceramic surface. Accessible, timeless beauty joined with the best techniques in durable, clean, and damage-resistant ceramic.

Gracias a las últimas innovaciones de la tecnología digital de tintas y esmaltes, conseguimos recrear la personalidad única del mármol sobre una superficie cerámica. Belleza atemporal accesible unida a las mejoras técnicas de durabilidad, limpieza y resistencia cerámica.





M **RU5** ALPEN QUARTZ MATT RECT
120 X 260 / 48" X 102"

J30/M

RU4 ALPEN QUARTZ POL RECT
90 X 90 / 36" X 36"

P47/M

G **RU4** ALPEN QUARTZ POL RECT
120 X 260 / 48" X 102"

J31/M

VARIACIÓN DE DISEÑO · GRAPHIC FACES



G **RU4** ALPEN QUARTZ POL RECT
60 X 120 / 24" X 48" J89/M

120X260 - 3 PIEZAS/3 PIECES/3 PIÈCES
60X120 - 12 PIEZAS/12 PIECES/12 PIÈCES
90X90 - 9 PIEZAS/9 PIECES/9 PIÈCES

CARACTERÍSTICAS TÉCNICAS · TECHNICAL CHARACTERISTICS

P PORCELÁNICO/PORCELAIN TILES
GRÉS CERÁME/FEINSTEINZEUG

V2 VARIACION LEVE/SLIGHT VARIATION
LÉGERE VARIATION/LEICHT FARBSPIEL

R RECTIFICADO/RECTIFIED
RECTIFIÉ/KALIBRIERT

ANT ANTIHIELO/FROST PROOF
RÉSISTANT AU GEL/FROSTSCHUTZ

FORMATO SIZE FORMAT VERPACKUNG	PZS/CAJA TILES/BOX PIÈCES/BOITE	M ² /CAJA SQM/BOX MÈTRES/BOITE	KG/CAJA KG/BOX KG/BOITE	CAJAS/PALLET BOXES/PALLET BOITES/PALETTE	M ² /PALLET SQM/PALLET MÈTRES/PALETTE	KG/PALLET KG/PALLET MÈTRES/PALETTE
120X260	1	3.12	52.50	13	40.56	683
90X90	1	0.81	19.25	44	35.48	847
60X120	2	1.43	32.87	30	42.98	986

Para más información técnica, especificaciones e imágenes visite nuestra web y busque: Alpen quartz
El embalaje de los artículos está sujeto a variaciones, para obtener el dato exacto y actual se recomienda consultar la web.

For more technical information, specifications and images, visit our website and search: Alpen quartz
The packing of our items is subject to variations. To get the most accurate and updated information, we recommend to check the website.

Pour plus d'informations techniques, de spécifications et de visuels, visitez notre site web et recherchez : Alpen quartz
L'emballage des articles est sujet à variation, pour obtenir les données exactes et actuelles il est recommandé de consulter notre site web.



MIRROR ALPEN QUARTZ A POL RECT 60X120. Z ALPEN QUARTZ B POL RECT 60X120. WOOD MATT RECT 60X120.

COMPOSICIÓN MIRROR · MIRROR COMPOSITION



G **RU4** MIRROR ALPEN QUARTZ A POL RECT
60 X 120 / 24" X 48" L32/M



G **RU4** MIRROR ALPEN QUARTZ B POL RECT
60 X 120 / 24" X 48" L32/M





VARIACIÓN DE DISEÑO · GRAPHIC FACES



AMARULA POL RECT
60 X 120 / 24" X 48"

J89/M

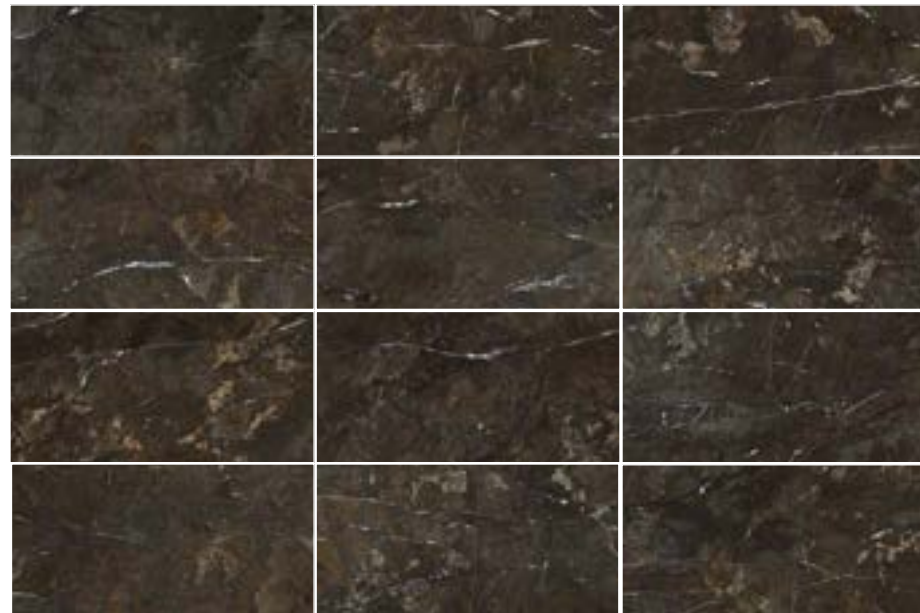

60X120 - 12 PIEZAS/12 PIECES/12 PIÈCES

COMPOSICIÓN MIRROR · MIRROR COMPOSITION



MIRROR AMARULA A POL RECT
60 X 120 / 24" X 48"

L32/M



MIRROR AMARULA B POL RECT
60 X 120 / 24" X 48"

L32/M

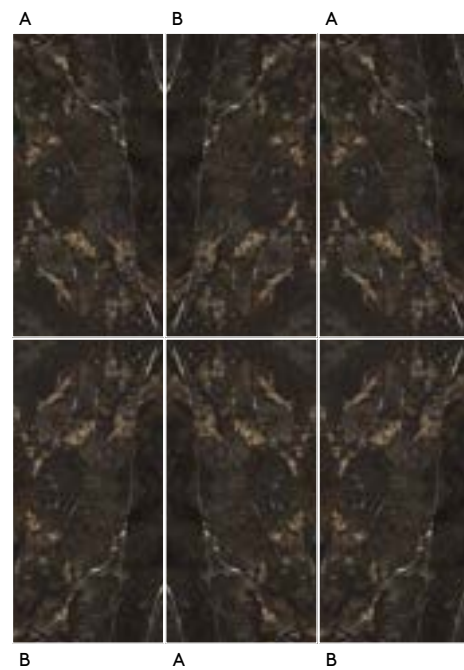

B A B

CARACTERÍSTICAS TÉCNICAS · TECHNICAL CHARACTERISTICS

- P** PORCELÁNICO/PORCELAIN TILES
GRÈS CERÁME/FEINSTEINZEUG
- V2** VARIACION LEVE/SLIGHT VARIATION
LÉGERÉ VARIATION/LEICHT FARBSPIEL
- G** GRANILLA PULIDA/GRAIN POLISHED
GRAIN POLI/TECHNISCHES POLIERTES FEINSTEINZEUG
- ANT** ANTIHIELO/FROST PROOF
RÉSISTANT AU GEL/FROSTSCHUTZ
- R** RECTIFICADO/RECTIFIED
RECTIFIÉ/KALIBRIERT
- RU4** USO RECOMENDADO/RECOMMENED USE - RU4

FORMATO SIZE FORMAT VERPACKUNG	PZS/CAJA TILES/BOX PIÈCES/BOITE	M²/CAJA SQM/BOX MÈTRES/BOITE	KG/CAJA KG/BOX KG/BOITE	CAJAS/PALLET BOXES/PALLET BOITES/PALETTE	M²/PALLET SQM/PALLET MÈTRES/PALETTE	KG/PALLET KG/PALLET MÈTRES/PALETTE
60X120	2	1.43	32.37	30	42.98	971

Para más información técnica, especificaciones e imágenes visite nuestra web y busque: Amarula
El embalaje de los artículos está sujeto a variaciones, para obtener el dato exacto y actual se recomienda consultar la web.
For more technical information, specifications and images, visit our website and search: Amarula
The packing of our items is subject to variations. To get the most accurate and updated information, we recommend to check the website.
Pour plus d'informations techniques, de spécifications et de visuels, visitez notre site web et recherchez : Amarula
L'emballage des articles est sujet à variation, pour obtenir les données exactes et actuelles il est recommandé de consulter notre site web.



AMARULA POL RECT 60X120, MIRROR AMARULA A POL RECT 60X120, MIRROR AMARULA B POL RECT 60X120.



AMARULA POL RECT 60X120, ZAIKU CARAMIELLO MATT RECT. 80X80



ALPI GREEN POL. RECT.
120 X 260 / 48" X 102"

J32/M



ALPI GREEN POL RECT
59 X 119 / 23" X 47"

N26/M



ALPI GREEN POL RECT
28 X 59 / 11" X 23"

J47/M



ALPI GREEN POL RECT
59 X 59 / 23" X 23"

J47/M



ALPI GREEN POL. RECT
14,5 X 14,5 / 5" X 5"

J96/M



ALPI GREEN POL. RECT
29,5 X 29,5 / 12" X 12"

J95/M

CARACTERÍSTICAS TÉCNICAS · TECHNICAL CHARACTERISTICS

- P** PORCELÁNICO/PORCELAIN TILES
GRÉS CERÁME/FEINSTEINZEUG
- V2** VARIACION LEVE/SLIGHT VARIATION
LÉGERÉ VARIATION/LEICHT FARBSPIEL
- G** GRANILLA PULIDA/GRAIN POLISHED
GRAIN POLI/TECHNISCHES POLIERTES FEINSTEINZEUG
- ANT** ANTIHIELO/FROST PROOF
RÉSISTANT AU GEL/FROSTSCHUTZ
- R** RECTIFICADO/RECTIFIED
RECTIFIÉ/KALIBRIERT
- RU4** USO RECOMENDADO/RECOMMENED USE - RU4
- M** MASA COLOREADA/COLORED BODY
TEINTÉE DANS LA MASSE/DURCHGEFÄRBT

FORMATO SIZE FORMAT VERPACKUNG	PZS/CAJA TILES/BOX PIÈCES/BOITE	M²/CAJA SQM/BOX MÈTRES/BOITE	KG/CAJA KG/BOX KG/BOITE	CAJAS/PALLET BOXES/PALLET BOITES/PALETTE	M²/PALLET SQM/PALLET MÈTRES/PALETTE	KG/PALLET KG/PALLET MÈTRES/PALETTE
120X260	1	3.12	52.50	13	40.56	683
59X119	2	1.40	33.81	27	37.80	913
59X59	3	1.04	25.63	32	33.28	820
14,5X14,5	15	0.33	7.72	140	46.20	1081
29,5X29,5	10	0.90	21.35	48	43.24	1025
28X59	6	0.99	23.98	40	39.65	959

Para más información técnica, especificaciones e imágenes visite nuestra web y busque: Alpi green
El embalaje de los artículos está sujeto a variaciones, para obtener el dato exacto y actual se recomienda consultar la web.
For more technical information, specifications and images, visit our website and search: Alpi green
The packing of our items is subject to variations. To get the most accurate and updated information, we recommend to check the website.
Pour plus d'informations techniques, de spécifications et de visuels, visitez notre site web et recherchez : Alpi green
L'emballage des articles est sujet à variation, pour obtenir les données exactes et actuelles il est recommandé de consulter notre site web.



ALPI GREEN POL. RECT 59X119

VARIACIÓN DE DISEÑO · GRAPHIC FACES

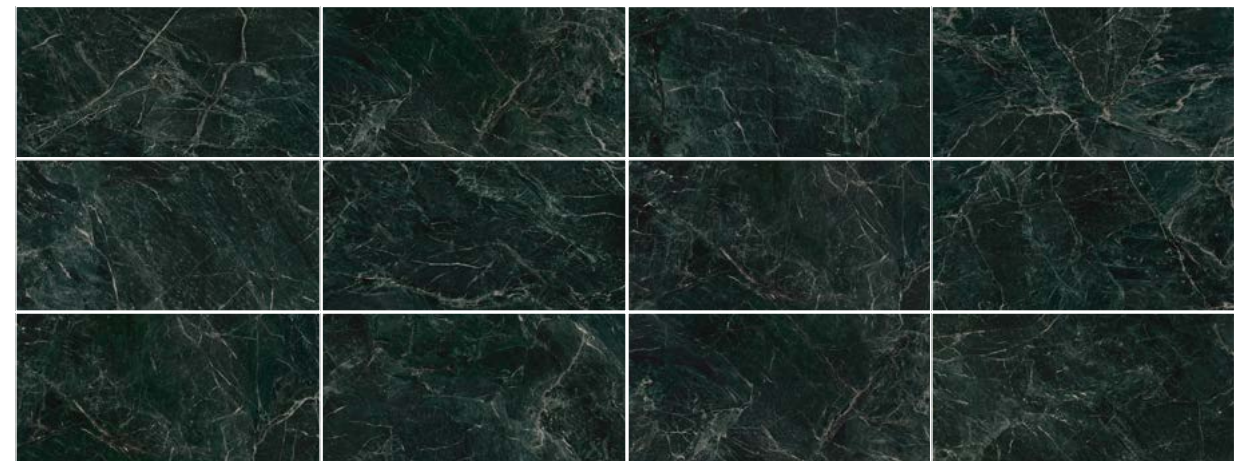

- 120X260 - 3 PIEZAS/3 PIECES/3 PIÈCES
- 59X119 - 12 PIEZAS/12 PIECES/12 PIÈCES
- 59X59 - 24 PIEZAS/24 PIECES/24 PIÈCES
- 28X59 - 48 PIEZAS/48 PIECES/48 PIÈCES
- 29,5X29,5 - 96 PIEZAS/96 PIECES/96 PIÈCES
- 14,5X14,5 - 384 PIEZAS/384 PIECES/384 PIÈCES



AMBOISE LUX POL RECT
120 X 120 / 48" X 48" **P41/M**



AMBOISE LUX MATT RECT
60 X 120 / 24" X 48" **P42/M**



DECOR CATEDRA LUX MATT
60 X 120 / 24" X 48" **K68/P**



AMBOISE LUX MATT RECT
80 X 80 / 32" X 32" **P44/M**

AMBOISE LUX POL RECT
80 X 80 / 32" X 32" **P45/M**

RODAPIÉS · SKIRTING BOARDS



ROD. AMBOISE LUX MATT
7.5 X 60 / 3" X 24" **K24/P**

ROD. AMBOISE LUX MATT
7.5 X 80 / 3" X 32" **K28/P**

ROD. AMBOISE LUX POL.
7.5 X 60 / 3" X 24" **K29/P**

ROD. AMBOISE LUX POL.
7.5 X 80 / 3" X 32" **K17/P**

CARACTERÍSTICAS TÉCNICAS · TECHNICAL CHARACTERISTICS

- P** PORCELÁNICO / PORCELAIN TILES
GRÉS CERÁME / FEINSTEINZEUG
- V2** VARIACION LEVE / SLIGHT VARIATION
LÉGERÉ VARIATION / LEICHT FARBSPIEL
- RECTIFICADO / RECTIFIED**
RECTIFIÉ / KALIBRIERT
- ANTIHIELO / FROST PROOF**
RÉSISTANT AU GEL / FROSTSCHUTZ

FORMATO SIZE FORMAT VERPACKUNG	PZS/CAJA TILES/BOX PIÈCES/BOITE	M ² /CAJA SQM/BOX MÈTRES/BOITE	KG/CAJA KG/BOX KG/BOITE	CAJAS/PALLET BOXES/PALLET BOITES/PALETTE	M ² /PALLET SQM/PALLET MÈTRES/PALETTE	KG/PALLET KG/PALLET MÈTRES/PALETTE
120X120	1	1.44	32.58	40	57.60	1303
80X80	2	1.28	28.05	42	53.76	1178
60X120	2	1.44	31.94	32	46.08	1022

Para más información técnica, especificaciones e imágenes visite nuestra web y busque: Amboise lux
El embalaje de los artículos está sujeto a variaciones, para obtener el dato exacto y actual se recomienda consultar la web.

For more technical information, specifications and images, visit our website and search: Amboise lux
The packing of our items is subject to variations. To get the most accurate and updated information, we recommend to check the website.

Pour plus d'informations techniques, de spécifications et de visuels, visitez notre site web et recherchez : Amboise lux
L'emballage des articles est sujet à variation, pour obtenir les données exactes et actuelles il est recommandé de consulter notre site web.



VARIACIÓN DE DISEÑO · GRAPHIC FACES



- 120X120** - 8 PIEZAS / 8 PIECES / 8 PIÈCES
- 60X120** - 16 PIEZAS / 16 PIECES / 16 PIÈCES
- 80X160** - 8 PIEZAS / 8 PIECES / 8 PIÈCES
- 80X80** - 12 PIEZAS / 12 PIECES / 12 PIÈCES



M **RU5** CALACATTA BORGHINI MATT RECT
120 X 120 / 48" X 48" **N31/M**

M **RU5** CALACATTA BORGHINI MATT RECT
60 X 120 / 24" X 48" **R60/M**

€ **RU4** DECOR SET(2) SAUVAGE POL. RECT
60 X 120 / 24" X 48" **K68/P**

M **C2** **RU5** CALACATTA BORGHINI C2 RECT
120 X 120 / 48" X 48" **N34/M**

M **C2** **RU5** CALACATTA BORGHINI C2 RECT
60 X 120 / 24" X 48" **N67/M**

€ **RU4** CALACATTA BORGHINI POL. RECT
120 X 120 / 48" X 48" **P06/M**

€ **RU4** CALACATTA BORGHINI POL. RECT
60 X 120 / 24" X 48" **J18/M**



M **RU5** CALACATTA BORGHINI MATT RECT.
60 X 60 / 24" X 24" **P07/M**

M **RU5** CALACATTA BORGHINI MATT RECT.
30 X 60 / 12" X 24" **P07/M**

M **C2** **RU5** CALACATTA BORGHINI C2 RECT.
60 X 60 / 24" X 24" **N18/M**

M **C2** **RU5** CALACATTA BORGHINI C2 RECT.
30 X 60 / 12" X 24" **N18/M**

€ **RU4** CALACATTA BORGHINI POL. RECT.
60 X 60 / 24" X 24" **N29/M**

€ **RU4** CALACATTA BORGHINI POL. RECT.
30 X 60 / 12" X 24" **N29/M**

RODAPÍÉS · SKIRTING BOARDS **P** **V2**

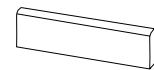

M **€** **RU4** ROD. CALACATTA BORGHINI MATT
7.5 X 60 / 3" X 24" **K24/P**

€ **RU4** ROD. CALACATTA BORGHINI POL. RECT.
7.5 X 60 / 3" X 24" **K29/P**



CALACATTA BORGHINI MATT RECT 120X120 CALACATTA BORGHINI MATT RECT 60X120

VARIACIÓN DE DISEÑO · GRAPHIC FACES



120X120 - 6 PIEZAS/6 PIECES/6 PIÈCES
60X120 - 12 PIEZAS/12 PIECES/12 PIÈCES
60X60 - 24 PIEZAS/24 PIECES/24 PIÈCES
30X60 - 48 PIEZAS/48 PIECES/48 PIÈCES



CALACATTA BORGHINI POL. RECT 120X120 CALACATTA BORGHINI POL. RECT 60X120

CARACTERÍSTICAS TÉCNICAS · TECHNICAL CHARACTERISTICS

- P** PORCELÁNICO/PORCELAIN TILES
GRÈS CERÁME/FEINSTEINZEUG
- V2** VARIACION LEVE/SLIGHT VARIATION
LÉGERÉ VARIATION / LEICHT FARBSPIEL
- RECTIFICADO/RECTIFIED**
RECTIFIÉ/KALIBRIERT
- ANTIHIELO/FROST PROOF**
RÉSISTANT AU GEL/FROSTSCHUTZ

FORMATO SIZE FORMAT VERPACKUNG	PZS/CAJA TILES/BOX PIÈCES/BOITE	M²/CAJA SQM/BOX MÈTRES/BOITE	KG/CAJA KG/BOX KG/BOITE	CAJAS/PALLET BOXES/PALLET BOITES/PALETTE	M²/PALLET SQM/PALLET MÈTRES/PALETTE	KG/PALLET KG/PALLET MÈTRES/PALETTE
120X120	1	1.44	38.17	36	51.84	1374
60X120	2	1.44	35.53	32	46.08	1137
60X60	4	1.44	31.50	30	43.20	945
30X60	6	1.08	23.55	48	51.84	1131

Para más información técnica, especificaciones e imágenes visite nuestra web y busque: Calacatta borghini
El embalaje de los artículos está sujeto a variaciones, para obtener el dato exacto y actual se recomienda consultar la web.
For more technical information, specifications and images, visit our website and search: Calacatta borghini
The packing of our items is subject to variations. To get the most accurate and updated information, we recommend to check the website.
Pour plus d'informations techniques, de spécifications et de visuels, visitez notre site web et recherchez: Calacatta borghini
L'emballage des articles est sujet à variation, pour obtenir les données exactes et actuelles il est recommandé de consulter notre site web.



M **RU5** CALACATTA GOLD MATT RECT
60 X 120 / 24" X 48" **R60/M**

E **RU4** CALACATTA GOLD POL. RECT
60 X 120 / 24" X 48" **J18/M**



M **RU5** CALACATTA SILVER MATT RECT
60 X 120 / 24" X 48" **R60/M**

E **RU4** CALACATTA SILVER POL. RECT
60 X 120 / 24" X 48" **J18/M**



E **RU4** CALACATTA GOLD POL. RECT
120 X 120 / 48" X 48" **P06/M**



E **RU4** CALACATTA SILVER POL. RECT
120 X 120 / 48" X 48" **P06/M**

VARIACIÓN DE DISEÑO · GRAPHIC FACES



120X120 - 6 PIEZAS/6 PIECES/6 PIÈCES
60X120 - 12 PIEZAS/12 PIECES/12 PIÈCES

RODAPÍÉS · SKIRTING BOARDS

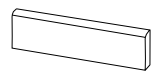

M ROD. CALACATTA MATT
7.5 X 60 / 3" X 24" **K24/P**

E ROD. CALACATTA POL.
7.5 X 60 / 3" X 24" **K29/P**



CALACATTA GOLD POL. RECT. 60X120. REALITY NIGHT. 7.5X30.

CARACTERÍSTICAS TÉCNICAS · TECHNICAL CHARACTERISTICS

- P** PORCELÁNICO/PORCELAIN TILES
GRÈS CERÁME/FEINSTEINZEUG
- V2** VARIACION LEVE/SLIGHT VARIATION
LÉGERE VARIATION/LEICHT FARBSPIEL
- RECTIFICADO/RECTIFIED**
RECTIFIÉ/KALIBRIERT
- ANTIHIELO/FROST PROOF**
RÉSISTANT AU GEL/FROSTSCHUTZ

FORMATO SIZE FORMAT VERPACKUNG	PZS/CAJA TILES/BOX PIÈCES/BOITE	M²/CAJA SQM/BOX MÈTRES/BOITE	KG/CAJA KG/BOX KG/BOITE	CAJAS/PALLET BOXES/PALLET BOITES/PALETTE	M²/PALLET SQM/PALLET MÈTRES/PALETTE	KG/PALLET KG/PALLET MÈTRES/PALETTE
120X120	1	1.44	36.11	36	51.84	1300
60X120	2	1.44	35.13	32	46.08	1124

Para más información técnica, especificaciones e imágenes visite nuestra web y busque: Calacatta gold/silver
El embalaje de los artículos está sujeto a variaciones, para obtener el dato exacto y actual se recomienda consultar la web.
For more technical information, specifications and images, visit our website and search: Calacatta gold/silver
The packing of our items is subject to variations. To get the most accurate and updated information, we recommend to check the website.
Pour plus d'informations techniques, de spécifications et de visuels, visitez notre site web et recherchez: Calacatta gold/silver
L'emballage des articles est sujet à variation, pour obtenir les données exactes et actuelles il est recommandé de consulter notre site web.



P M CALACATTA SLOW MATT RECT. 120 X 260 / 48" X 102" **J30/M**

P G CALACATTA SLOW POL RECT. 120 X 260 / 48" X 102" **J31/M**



P M CALACATTA SLOW MATT RECT. 120 X 120 / 48" X 48" **N31/M**

P E CALACATTA SLOW POL. RECT. 120 X 120 / 48" X 48" **P06/M**



P M CALACATTA SLOW MATT RECT. 90 X 90 / 36" X 36" **L34/M**

P E CALACATTA SLOW POL RECT. 90 X 90 / 36" X 36" **P36/M**



P M CALACATTA SLOW MATT RECT. 60 X 120 / 24" X 48" **R60/M**

P E CALACATTA SLOW POL RECT. 60 X 120 / 24" X 48" **J18/M**



P M CALACATTA SLOW MATT RECT. 60 X 60 / 24" X 24" **P07/M**

P E CALACATTA SLOW POL RECT. 60 X 60 / 24" X 24" **N29/M**



P DECOR SET(2) CALACATTA SLOW POL. 60 X 120 / 24" X 48" **K68/P**



PB M CALACATTA SLOW MATT RECT. 40 X 120 / 16" X 48" **L25/M**



PB M PLACID CALACATTA SLOW MATT RECT. 40 X 120 / 16" X 48" **L26/M**



PB M CALACATTA SLOW MATT 75 X 30 / 3" X 12" **L20/M**



PB M DECOR SET(2) FRAGRANT CALACATTA 40 X 120 / 16" X 48" **K81/P**



P M HEXAGON CALACATTA SLOW 13,9 X 16 / 5.5" X 6.3" **N70/M**



P B HEXA BOHO CALACATTA SLOW 13,9 X 16 / 5.5" X 6.3" **L07/M**



VARIACIÓN DE DISEÑO · GRAPHIC FACES

120X260 - 3 PIEZAS/3 PIECES/3 PIÈCES
 120X120 - 6 PIEZAS/6 PIECES/6 PIÈCES
 60X120 - 12 PIEZAS/12 PIECES/12 PIÈCES
 40X120 - 18 PIEZAS/18 PIECES/18 PIÈCES
 60X60 - 24 PIEZAS/24 PIECES/24 PIÈCES
 90X90 - 6 PIEZAS/6 PIECES/6 PIÈCES
 7,5X30 - 40 PIEZAS/40 PIECES/40 PIÈCES

CARACTERÍSTICAS TÉCNICAS · TECHNICAL CHARACTERISTICS

LÉGERE VARIATION / LEICHT FARBSPIEL

V2 VARIACION LEVE / SLIGHT VARIATION

FORMATO SIZE FORMAT VERPACKUNG	PZS/CAJA TILES/BOX PIÈCES/BOITE	M²/CAJA SQM/BOX MÈTRES/BOITE	KG/CAJA KG/BOX KG/BOITE	CAJAS/PALLET BOXES/PALLET BOITES/PALETTE	M²/PALLET SQM/PALLET MÈTRES/PALETTE	KG/PALLET KG/PALLET MÈTRES/PALETTE
120X260	1	3.12	52.50	13	40.56	683
120X120	1	1.44	36.72	36	51.84	1322
90X90	2	1.62	41.19	27	43.74	1112
60X120	2	1.44	34.88	32	46.08	1116
60X60	4	1.44	31.73	30	43.20	952
40X120	3	1.44	28.85	20	28.80	577
13,9X16	20	0.33	6.80	105	34.65	714
7,5X30	44	1.00	14.55	60	60.00	873

Para más información técnica, especificaciones e imágenes visite nuestra web y busque: Calacatta slow

El embalaje de los artículos está sujeto a variaciones, para obtener el dato exacto y actual se recomienda consultar la web.

For more technical information, specifications and images, visit our website and search: Calacatta slow

The packing of our items is subject to variations. To get the most accurate and updated information, we recommend to check the website.

Pour plus d'informations techniques, de spécifications et de visuels, visitez notre site web et recherchez: Calacatta slow

L'emballage des articles est sujet à variation, pour obtenir les données exactes et actuelles il est recommandé de consulter notre site web.



EDGE STICK CALACATTA SLOW 1,5 X 30 / 0,6" X 12" **K18/P**



M **RUS** CERVINO MATT RECT
120 X 120 / 48" X 48"

N31/M



M **RUS** CERVINO MATT RECT
60 X 120 / 24" X 48" R60/M



M DECOR BAEZA MATT
60 X 120 / 24" X 48" K68/P

E **RU4** CERVINO POL RECT
120 X 120 / 48" X 48"

PO6/M

E **RU4** CERVINO POL RECT
60 X 120 / 24" X 48" J18/M



E **RU4** CERVINO POL RECT
80 X 80 / 32" X 32"

P45/M

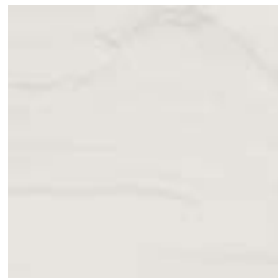

E **RU4** CERVINO POL. RECT.
60 X 60 / 24" X 24" N29/M



E **RU4** CERVINO POL. RECT.
30 X 60 / 12" X 24" N29/M

CARACTERÍSTICAS TÉCNICAS · TECHNICAL CHARACTERISTICS

P PORCELÁNICO/PORCELAIN TILES
GRÉS CERÁME/FEINSTEINZEUG

V2 VARIACION LEVE/SLIGHT VARIATION
LÉGERE VARIATION/LEICHT FARBSPIEL

R RECTIFICADO/RECTIFIED
RECTIFIÉ/KALIBRIERT

ANT ANTIHIELO/FROST PROOF
RÉSISTANT AU GEL/FROSTSCHUTZ

FORMATO SIZE FORMAT VERPACKUNG	PZS/CAJA TILES/BOX PIÈCES/BOITE	M²/CAJA SQM/BOX MÈTRES/BOITE	KG/CAJA KG/BOX KG/BOITE	CAJAS/PALLET BOXES/PALLET BOITES/PALETTE	M²/PALLET SQM/PALLET MÈTRES/PALETTE	KG/PALLET KG/PALLET MÈTRES/PALETTE
120X120	1	1.44	35.89	36	51.84	1292
80X80	2	1.28	28.90	42	53.76	1214
60X120	2	1.44	35.16	32	46.08	1125
60X60	4	1.44	31.87	30	43.20	956
30X60	6	1.08	23.19	48	51.84	1113

Para más información técnica, especificaciones e imágenes visite nuestra web y busque: Cervino
El embalaje de los artículos está sujeto a variaciones, para obtener el dato exacto y actual se recomienda consultar la web.

For more technical information, specifications and images, visit our website and search: Cervino
The packing of our items is subject to variations. To get the most accurate and updated information, we recommend to check the website.

Pour plus d'informations techniques, de spécifications et de visuels, visitez notre site web et recherchez : Cervino
L'emballage des articles est sujet à variation, pour obtenir les données exactes et actuelles il est recommandé de consulter notre site web.



CERVINO MATT RECT 120X120/DECOR BAEZA MATT 60X120

VARIACIÓN DE DISEÑO · GRAPHIC FACES

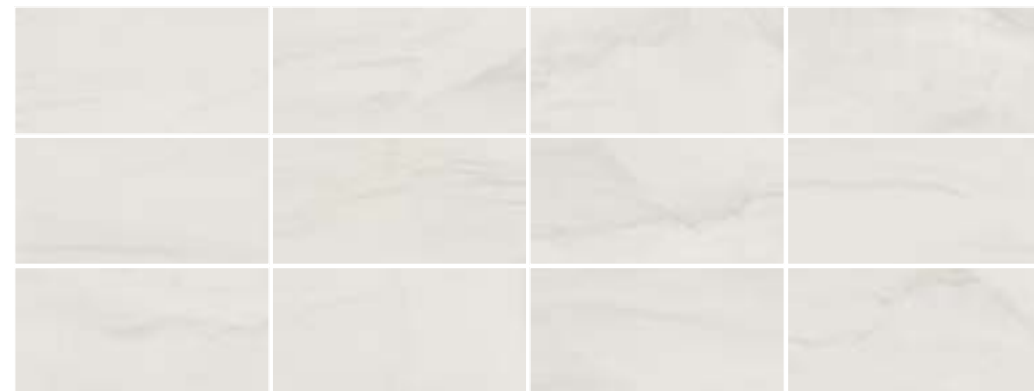

120X120 - 6 PIEZAS/6 PIECES/6 PIÈCES
60X120 - 12 PIEZAS/12 PIECES/12 PIÈCES
60X60 - 24 PIEZAS/24 PIECES/24 PIÈCES
30X60 - 48 PIEZAS/48 PIECES/48 PIÈCES
80X80 - 6 PIEZAS/6 PIECES/6 PIÈCES

RODAPIÉS · SKIRTING BOARDS

P **R** **V2**



M ROD. CERVINO MATT
7.5 X 60 / 3" X 24" K24/P



M ROD. CERVINO MATT
7.5 X 80 / 3" X 32" K28/P

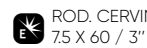

E ROD. CERVINO POL.
7.5 X 60 / 3" X 24" K29/P



E ROD. CERVINO POL.
7.5 X 80 / 3" X 32" K17/P



M **RU5** LUNA BLANCA MATT RECT
120 X 260 / 48" X 102"

J30/M

G **RU4** LUNA BLANCA POL RECT
120 X 260 / 48" X 102"

J31/M

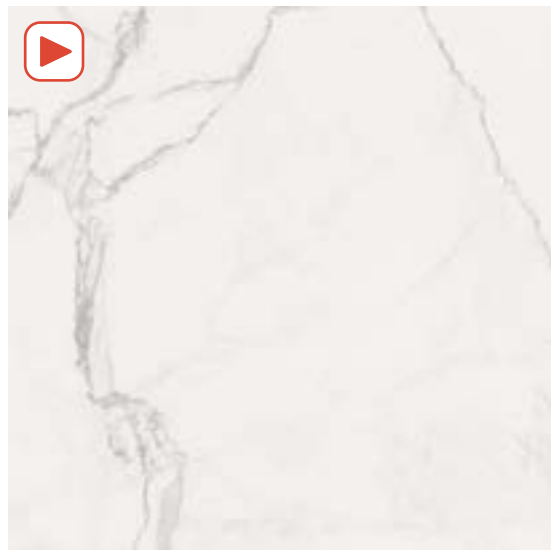

E **RU4** LUNA BLANCA POL RECT
120 X 120 / 48" X 48"

P06/M

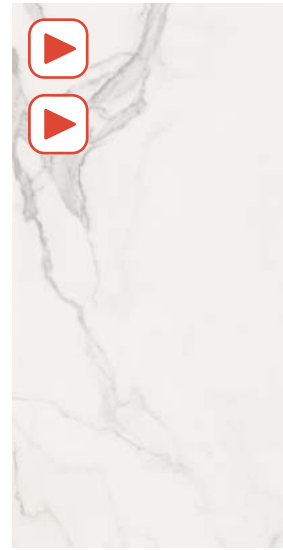

M **RU5** LUNA BLANCA MATT RECT
60 X 60 / 24" X 24" **P07/M**

E **RU4** LUNA BLANCA POL RECT.
60 X 60 / 24" X 24" **N29/M**

M **RU5** LUNA BLANCA MATT RECT
60 X 120 / 24" X 48" **R60/M**

E **RU4** LUNA BLANCA POL RECT
60 X 120 / 24" X 48" **J18/M**

* REFERENCIAS MATE DISPONIBLE EN C2 BAJO PEDIDO
MATT FINISH AVAILABLE IN C2 UNDER SPECIAL ORDER

120 X 120 / 48" X 48" **N34/M**
60 X 120 / 24" X 48" **N67/M**
60 X 60 / 24" X 24" **N18/M**

RODAPÍÉS · SKIRTING BOARDS



M ROD. LUNA BLANCA MATT
7.5 X 60 / 3" X 24" **K24/P**

E ROD. LUNA BLANCA POL.
7.5 X 60 / 3" X 24" **K29/P**



VARIACIÓN DE DISEÑO · GRAPHIC FACES



120X260 - 3 PIEZAS/3 PIECES/3 PIÈCES
120X120 - 6 PIEZAS/6 PIECES/6 PIÈCES
60X120 - 12 PIEZAS/12 PIECES/12 PIÈCES
60X60 - 24 PIEZAS/24 PIECES/24 PIÈCES

CARACTERÍSTICAS TÉCNICAS · TECHNICAL CHARACTERISTICS

P PORCELÁNICO/PORCELAIN TILES
GRÉS CERÁME/FEINSTEINZEUG

V2 VARIACION LEVE/SLIGHT VARIATION
LÉGERÉ VARIATION /LEICHT FARBSPIEL

R RECTIFICADO/RECTIFIED
RECTIFIÉ/KALIBRIERT

S ANTIHIELO/FROST PROOF
RÉSISTANT AU GEL/FROSTSCHUTZ

FORMATO SIZE FORMAT VERPACKUNG	PZS/CAJA TILES/BOX PIÈCES/BOITE	M ² /CAJA SQM/BOX MÈTRES/BOITE	KG/CAJA KG/BOX KG/BOITE	CAJAS/PALLET BOXES/PALLET BOITES/PALETTE	M ² /PALLET SQM/PALLET MÈTRES/PALETTE	KG/PALLET KG/PALLET MÈTRES/PALETTE
120X260	1	3.12	52.50	13	40.56	683
120X120	1	1.44	35.33	36	51.84	1272
60X120	2	1.44	33.66	32	46.08	1077
60X60	4	1.44	31.30	30	43.20	939

Para más información técnica, especificaciones e imágenes visite nuestra web y busque: Luna blanca
El embalaje de los artículos está sujeto a variaciones, para obtener el dato exacto y actual se recomienda consultar la web.

For more technical information, specifications and images, visit our website and search: Luna blanca
The packing of our items is subject to variations. To get the most accurate and updated information, we recommend to check the website.

Pour plus d'informations techniques, de spécifications et de visuels, visitez notre site web et recherchez: Luna blanca
L'emballage des articles est sujet à variation, pour obtenir les données exactes et actuelles il est recommandé de consulter notre site web.



LUNA BLANCA MATT RECT.
40 X 120 / 16" X 48" **L25/M**



NIGHT LUX MATT RECT.
40 X 120 / 16" X 48" **L25/M**



ESSENCE LUNA BLANCA MATT RECT.
40 X 120 / 16" X 48" **L26/M**



OPERA NIGHT LUX MATT RECT.
40 X 120 / 16" X 48" **L26/M**



DECOR SET(2) LUNA BLANCA
40 X 120 / 16" X 48" **K81/P**



VARIACIÓN DE DISEÑO · GRAPHIC FACES

LUNA BLANCA - 12 PIECES / 12 PIECES / 12 PIÈCES
NIGHT LUX - 15 PIECES / 15 PIECES / 15 PIÈCES

CARACTERÍSTICAS TÉCNICAS · TECHNICAL CHARACTERISTICS

- PB** PASTA BLANCA / WHITE BODY
PÂTE BLANCHE / WEISSCHERBIG
- RE** RECTIFICADO / RECTIFIED
RECTIFIÉ / KALIBRIERT
- W** REVESTIMIENTO / WALL TILE
FAÏENCE / WANDFLIESEN
- V2** VARIACION LEVE / SLIGHT VARIATION
LÉGERÉ VARIATION / LEICHT FARBSPIEL
- M** MATE / MATT
MAT / MATT

FORMATO SIZE FORMAT VERPACKUNG	PZS/CAJA TILES/BOX PIÈCES/BOITE	M²/CAJA SQM/BOX MÈTRES/BOITE	KG/CAJA KG/BOX KG/BOITE	CAJAS/PALLET BOXES/PALLET BOITES/PALETTE	M²/PALLET SQM/PALLET MÈTRES/PALETTE	KG/PALLET KG/PALLET MÈTRES/PALETTE
40X120	3	1.44	28.75	20	28.80	575

Para más información técnica, especificaciones e imágenes visite nuestra web y busque: Luna blanca 40x120
El embalaje de los artículos está sujeto a variaciones, para obtener el dato exacto y actual se recomienda consultar la web.

For more technical information, specifications and images, visit our website and search: Luna blanca 40x120
The packing of our items is subject to variations. To get the most accurate and updated information, we recommend to check the website.

Pour plus d'informations techniques, de spécifications et de visuels, visitez notre site web et recherchez : Luna blanca 40x120
L'emballage des articles est sujet à variation, pour obtenir les données exactes et actuelles il est recommandé de consulter notre site web.





AMAZONITE POL RECT
120 X 120 / 48" X 48"

P52/M

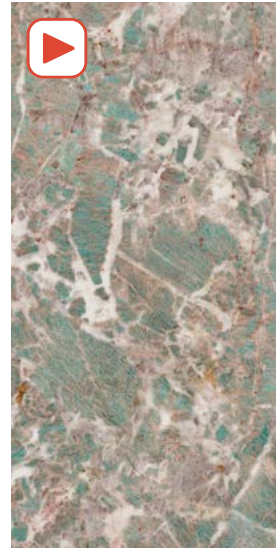

AMAZONITE POL RECT
60 X 120 / 24" X 48"

P34/M

VARIACIÓN DE DISEÑO · GRAPHIC FACES

120X120 - 9 PIEZAS/9 PIECES/9 PIÈCES
60X120 - 18 PIEZAS/18 PIECES/18 PIÈCES

RODAPIÉS · SKIRTING BOARDS

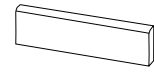

ROD. AMAZONITE POL.
75 X 60 / 3" X 24" K29/P



AMAZONITE POL RECT 60X120-ANTI-SLIP WORK B TAUPE RECT. 60X120.
PELDAÑO RECTO ANT. C3 WORK W NATURAL 33X120

CARACTERÍSTICAS TÉCNICAS · TECHNICAL CHARACTERISTICS

- P** PORCELÁNICO/PORCELAIN TILES
GRÈS CERÁME/FEINSTEINZEUG
- G** GRANILLA PULIDA/GRAIN POLISHED
GRAIN POLI/TECHNISCHES POLIERTES FEINSTEINZEUG
- RE** RECTIFICADO/RECTIFIED
RECTIFIÉ/KALIBRIERT
- V2** VARIACION LEVE/SLIGHT VARIATION
LÉGERÉ VARIATION/LEICHT FARBSPIEL
- SN** ANTIHIELO/FROST PROOF
RÉSISTANT AU GEL/FROSTSCHUTZ
- RU4** USO RECOMENDADO/RECOMMENED USE - RU4

FORMATO SIZE FORMAT VERPACKUNG	PZS/CAJA TILES/BOX PIÈCES/BOITE	M²/CAJA SQM/BOX MÈTRES/BOITE	KG/CAJA KG/BOX KG/BOITE	CAJAS/PALLET BOXES/PALLET BOITES/PALETTE	M²/PALLET SQM/PALLET MÈTRES/PALETTE	KG/PALLET KG/PALLET MÈTRES/PALETTE
120X120	1	1.44	37.00	36	51.84	1332
60X120	2	1.44	33.94	32	46.08	1086

Para más información técnica, especificaciones e imágenes visite nuestra web y busque: Amazonite
El embalaje de los artículos está sujeto a variaciones, para obtener el dato exacto y actual se recomienda consultar la web.

For more technical information, specifications and images, visit our website and search: Amazonite
The packing of our items is subject to variations. To get the most accurate and updated information, we recommend to check the website.

Pour plus d'informations techniques, de spécifications et de visuels, visitez notre site web et recherchez: Amazonite
L'emballage des articles est sujet à variation, pour obtenir les données exactes et actuelles il est recommandé de consulter notre site web.



BLUE EXPLOSION POL RECT
60 X 120 / 24" X 48"

P34/M

RODAPIÉS · SKIRTING BOARDS



ROD. BLUE EXPLOSION POL.
75 X 60 / 3" X 24" K29/P

VARIACIÓN DE DISEÑO · GRAPHIC FACES

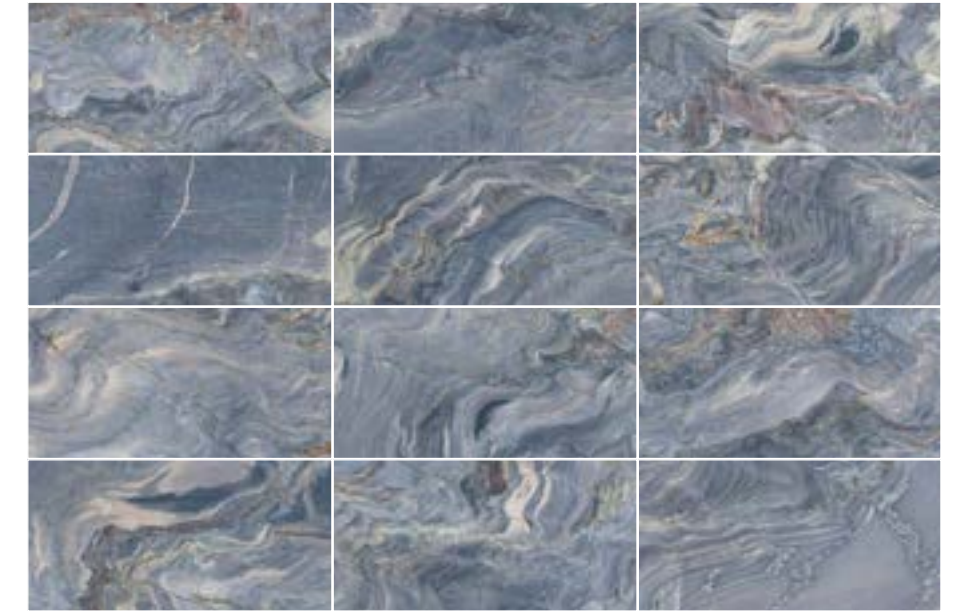

60X120 - 12 PIEZAS/12 PIECES/12 PIÈCES



BLUE EXPLOSION POL RECT 60X120.

CARACTERÍSTICAS TÉCNICAS · TECHNICAL CHARACTERISTICS

- P** PORCELÁNICO/PORCELAIN TILES
GRÈS CERÁME/FEINSTEINZEUG
- G** GRANILLA PULIDA/GRAIN POLISHED
GRAIN POLI/TECHNISCHES POLIERTES FEINSTEINZEUG
- RE** RECTIFICADO/RECTIFIED
RECTIFIÉ/KALIBRIERT
- V3** VARIACION MODERADA/MODERATE VARIATION
MODÉRÉE VARIATION/MITTLERES FARBSPIEL
- SN** ANTIHIELO/FROST PROOF
RÉSISTANT AU GEL/FROSTSCHUTZ
- RU4** USO RECOMENDADO/RECOMMENED USE - RU4

FORMATO SIZE FORMAT VERPACKUNG	PZS/CAJA TILES/BOX PIÈCES/BOITE	M²/CAJA SQM/BOX MÈTRES/BOITE	KG/CAJA KG/BOX KG/BOITE	CAJAS/PALLET BOXES/PALLET BOITES/PALETTE	M²/PALLET SQM/PALLET MÈTRES/PALETTE	KG/PALLET KG/PALLET MÈTRES/PALETTE
60X120	2	1.44	34.41	32	46.08	1101

Para más información técnica, especificaciones e imágenes visite nuestra web y busque: Blue explosion
El embalaje de los artículos está sujeto a variaciones, para obtener el dato exacto y actual se recomienda consultar la web.

For more technical information, specifications and images, visit our website and search: Blue explosion
The packing of our items is subject to variations. To get the most accurate and updated information, we recommend to check the website.

Pour plus d'informations techniques, de spécifications et de visuels, visitez notre site web et recherchez: Blue explosion
L'emballage des articles est sujet à variation, pour obtenir les données exactes et actuelles il est recommandé de consulter notre site web.

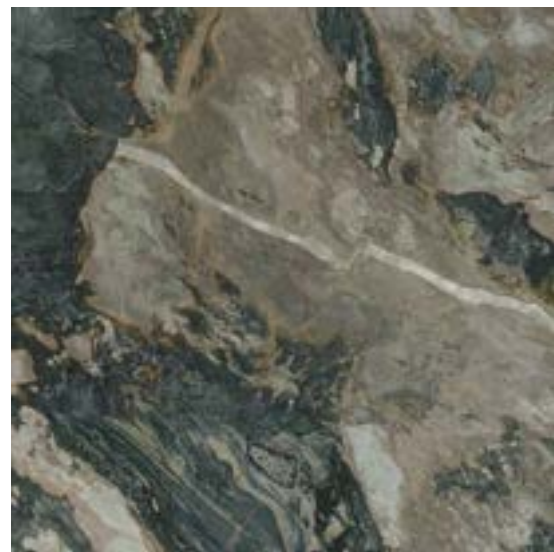

DEDALUS POL RECT
120 X 120 / 48" X 48"

P52/M



DEDALUS POL RECT
60 X 120 / 24" X 48"

P34/M

VARIACIÓN DE DISEÑO · GRAPHIC FACES

120X120 - 9 PIEZAS/9 PIECES/9 PIÈCES
60X120 - 18 PIEZAS/18 PIECES/18 PIÈCES

RODAPIÉS · SKIRTING BOARDS

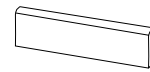

ROD. DEDALUS POL.
75 X 60 / 3" X 24" K29/P



DEDALUS POL RECT 120X120, DEDALUS POL RECT 60X120

CARACTERÍSTICAS TÉCNICAS · TECHNICAL CHARACTERISTICS

- P** PORCELÁNICO/PORCELAIN TILES
GRÈS CERÁME/FEINSTEINZEUG
- G** GRANILLA PULIDA/GRAIN POLISHED
GRAIN POLI/TECHNISCHES POLIERTES FEINSTEINZEUG
- RE** RECTIFICADO/RECTIFIED
RECTIFIÉ/KALIBRIERT
- V4** VARIACION FUERTE/SUBSTANTIAL VARIATION
FORTE VARIATION/HOHES FARBSPIEL
- SN** ANTIHIELO/FROST PROOF
RÉSISTANT AU GEL/FROSTSCHUTZ
- RU4** USO RECOMENDADO/RECOMMENED USE - RU4

FORMATO SIZE FORMAT VERPACKUNG	PZS/CAJA TILES/BOX PIÈCES/BOITE	M²/CAJA SQM/BOX MÈTRES/BOITE	KG/CAJA KG/BOX KG/BOITE	CAJAS/PALLET BOXES/PALLET BOITES/PALETTE	M²/PALLET SQM/PALLET MÈTRES/PALETTE	KG/PALLET KG/PALLET MÈTRES/PALETTE
120X120	9	1.44	38.00	36	51.84	1368
60X120	18	1.44	34.72	32	46.08	1111

Para más información técnica, especificaciones e imágenes visite nuestra web y busque: Dedalus
El embalaje de los artículos está sujeto a variaciones, para obtener el dato exacto y actual se recomienda consultar la web.

For more technical information, specifications and images, visit our website and search: Dedalus
The packing of our items is subject to variations. To get the most accurate and updated information, we recommend to check the website.

Pour plus d'informations techniques, de spécifications et de visuels, visitez notre site web et recherchez : Dedalus
L'emballage des articles est sujet à variation, pour obtenir les données exactes et actuelles il est recommandé de consulter notre site web.



EMERALD ONIX POL RECT
60 X 120 / 24" X 48"

P34/M

RODAPIÉS · SKIRTING BOARDS

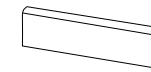

ROD. EMERALD ONIX POL.
75 X 60 / 3" X 24" K29/P

VARIACIÓN DE DISEÑO · GRAPHIC FACES

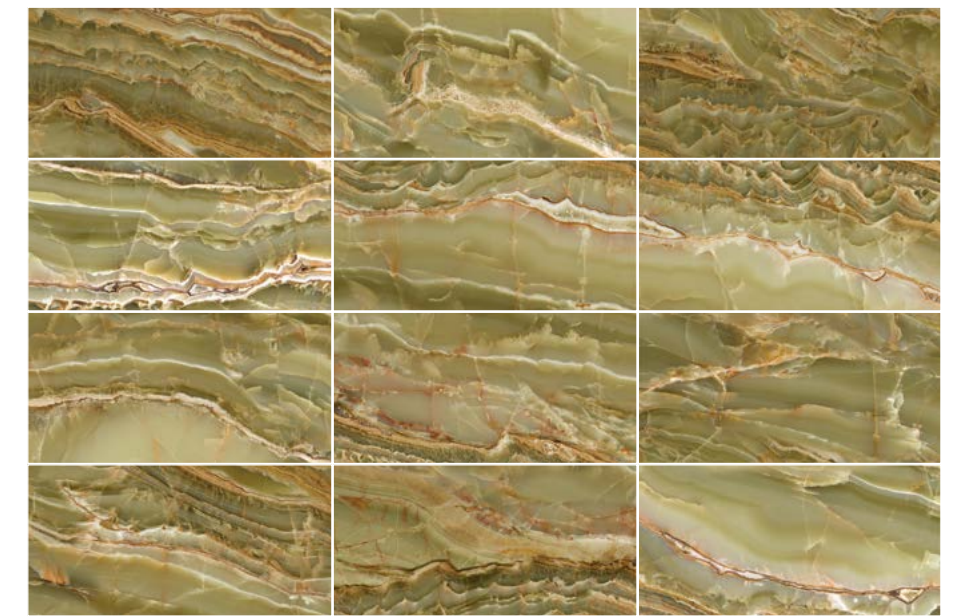

60X120 - 12 PIEZAS/12 PIECES/12 PIÈCES



EMERALD ONIX POL RECT 60X120, EMERALD ONIX POL RECT 120X120, PUMICE MATT RECT 60X120

CARACTERÍSTICAS TÉCNICAS · TECHNICAL CHARACTERISTICS

- P** PORCELÁNICO/PORCELAIN TILES
GRÈS CERÁME/FEINSTEINZEUG
- G** GRANILLA PULIDA/GRAIN POLISHED
GRAIN POLI/TECHNISCHES POLIERTES FEINSTEINZEUG
- RE** RECTIFICADO/RECTIFIED
RECTIFIÉ/KALIBRIERT
- V2** VARIACION LEVE/SLIGHT VARIATION
LÉGERÉ VARIATION/LEICHT FARBSPIEL
- SN** ANTIHIELO/FROST PROOF
RÉSISTANT AU GEL/FROSTSCHUTZ
- RU4** USO RECOMENDADO/RECOMMENED USE - RU4

FORMATO SIZE FORMAT VERPACKUNG	PZS/CAJA TILES/BOX PIÈCES/BOITE	M²/CAJA SQM/BOX MÈTRES/BOITE	KG/CAJA KG/BOX KG/BOITE	CAJAS/PALLET BOXES/PALLET BOITES/PALETTE	M²/PALLET SQM/PALLET MÈTRES/PALETTE	KG/PALLET KG/PALLET MÈTRES/PALETTE
60X120	12	1.44	35.47	32	46.08	1135

Para más información técnica, especificaciones e imágenes visite nuestra web y busque: Emerald onix
El embalaje de los artículos está sujeto a variaciones, para obtener el dato exacto y actual se recomienda consultar la web.

For more technical information, specifications and images, visit our website and search: Emerald onix
The packing of our items is subject to variations. To get the most accurate and updated information, we recommend to check the website.

Pour plus d'informations techniques, de spécifications et de visuels, visitez notre site web et recherchez : Emerald onix
L'emballage des articles est sujet à variation, pour obtenir les données exactes et actuelles il est recommandé de consulter notre site web.

Eternal gold



ETERNAL GOLD POL. RECT
120 X 120 / 48" X 48"

P52/M



ETERNAL GOLD POL. RECT
60 X 120 / 24" X 48"

P34/M

VARIACIÓN DE DISEÑO · GRAPHIC FACES

120X120 - 6 PIEZAS/6 PIECES/6 PIÈCES
60X120 - 12 PIEZAS/12 PIECES/12 PIÈCES

RODAPIÉS · SKIRTING BOARDS

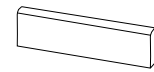

ROD. ETERNAL GOLD POL.
75 X 60 / 3" X 24" K29/P



ETERNAL GOLD POL. RECT 60X120.ETERNAL GOLD POL. RECT 120X120.TRIANA CAOBA RECT 20X120

CARACTERÍSTICAS TÉCNICAS · TECHNICAL CHARACTERISTICS

- P** PORCELÁNICO/PORCELAIN TILES
GRÈS CERÁME/FEINSTEINZEUG
- G** GRANILLA PULIDA/GRAIN POLISHED
GRAIN POLI/TECHNISCHES POLIERTES FEINSTEINZEUG
- RECTIFICADO/RECTIFIED**
RECTIFIÉ/KALIBRIERT
- V2** VARIACION LEVE/SLIGHT VARIATION
LÉGERÉ VARIATION/LEICHT FARBSPIEL
- ANTIHIELO/FROST PROOF**
RÉSISTANT AU GEL/FROSTSCHUTZ
- RU4** USO RECOMENDADO/RECOMMENED USE - RU4

FORMATO SIZE FORMAT VERPACKUNG	PZS/CAJA TILES/BOX PIÈCES/BOITE	M²/CAJA SQM/BOX MÈTRES/BOITE	KG/CAJA KG/BOX KG/BOITE	CAJAS/PALLET BOXES/PALLET BOITES/PALETTE	M²/PALLET SQM/PALLET MÈTRES/PALETTE	KG/PALLET KG/PALLET MÈTRES/PALETTE
120X120	1	1.44	37.47	36	51.84	1349
60X120	2	1.44	33.75	32	46.08	1080

Para más información técnica, especificaciones e imágenes visite nuestra web y busque: Eternal gold
El embalaje de los artículos está sujeto a variaciones, para obtener el dato exacto y actual se recomienda consultar la web.

For more technical information, specifications and images, visit our website and search: Eternal gold
The packing of our items is subject to variations. To get the most accurate and updated information, we recommend to check the website.

Pour plus d'informations techniques, de spécifications et de visuels, visitez notre site web et recherchez : Eternal gold
L'emballage des articles est sujet à variation, pour obtenir les données exactes et actuelles il est recommandé de consulter notre site web.

Fior di pesco



FIOR DI PESCO POL. RECT
60 X 120 / 24" X 48"

P34/M

RODAPIÉS · SKIRTING BOARDS

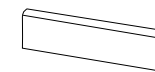

ROD. FIOR DI PESCO POL.
75 X 60 / 3" X 24" K29/P

VARIACIÓN DE DISEÑO · GRAPHIC FACES



60X120 - 12 PIEZAS/12 PIECES/12 PIÈCES



FIOR DI PESCO POL. RECT 60X120.TERRACOTTA MATT RECT 60X120.

CARACTERÍSTICAS TÉCNICAS · TECHNICAL CHARACTERISTICS

- P** PORCELÁNICO/PORCELAIN TILES
GRÈS CERÁME/FEINSTEINZEUG
- G** GRANILLA PULIDA/GRAIN POLISHED
GRAIN POLI/TECHNISCHES POLIERTES FEINSTEINZEUG
- RECTIFICADO/RECTIFIED**
RECTIFIÉ/KALIBRIERT
- V2** VARIACION LEVE/SLIGHT VARIATION
LÉGERÉ VARIATION/LEICHT FARBSPIEL
- ANTIHIELO/FROST PROOF**
RÉSISTANT AU GEL/FROSTSCHUTZ
- RU4** USO RECOMENDADO/RECOMMENED USE - RU4

FORMATO SIZE FORMAT VERPACKUNG	PZS/CAJA TILES/BOX PIÈCES/BOITE	M²/CAJA SQM/BOX MÈTRES/BOITE	KG/CAJA KG/BOX KG/BOITE	CAJAS/PALLET BOXES/PALLET BOITES/PALETTE	M²/PALLET SQM/PALLET MÈTRES/PALETTE	KG/PALLET KG/PALLET MÈTRES/PALETTE
60X120	2	1.44	35.25	32	46.08	1128

Para más información técnica, especificaciones e imágenes visite nuestra web y busque: Fior di pesco
El embalaje de los artículos está sujeto a variaciones, para obtener el dato exacto y actual se recomienda consultar la web.

For more technical information, specifications and images, visit our website and search: Fior di pesco
The packing of our items is subject to variations. To get the most accurate and updated information, we recommend to check the website.

Pour plus d'informations techniques, de spécifications et de visuels, visitez notre site web et recherchez : Fior di pesco
L'emballage des articles est sujet à variation, pour obtenir les données exactes et actuelles il est recommandé de consulter notre site web.



JADORE POL RECT
60 X 120 / 24" X 48" P34/M

VARIACIÓN DE DISEÑO · GRAPHIC FACES

60X120 - 12 PIEZAS/12 PIECES/12 PIÈCES

RODAPIÉS · SKIRTING BOARDS

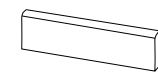

ROD. JADORE POL.
75 X 60 / 3" X 24" K29/P



JADORE POL RECT 60X120 KOEN MIELE MATT RECT. 30X120.

CARACTERÍSTICAS TÉCNICAS · TECHNICAL CHARACTERISTICS

- P** PORCELÁNICO/PORCELAIN TILES
GRÉS CERÁME/FEINSTEINZEUG
- G** GRANILLA PULIDA/GRAIN POLISHED
GRAIN POLI/TECHNISCHES POLIERTES FEINSTEINZEUG
- V2** VARIACION LEVE/SLIGHT VARIATION
LÉGERÉ VARIATION/LEICHT FARBSPIEL
- ANTHIELO/FROST PROOF**
RÉSISTANT AU GEL/FROSTSCHUTZ
- RECTIFICADO/RECTIFIED**
RECTIFIÉ/KALIBRIERT
- RU4** USO RECOMENDADO/RECOMMENED USE - RU4

FORMATO SIZE FORMAT VERPACKUNG	PZS/CAJA TILES/BOX PIÈCES/BOITE	M²/CAJA SQM/BOX MÈTRES/BOITE	KG/CAJA KG/BOX KG/BOITE	CAJAS/PALLET BOXES/PALLET BOITES/PALETTE	M²/PALLET SQM/PALLET MÈTRES/PALETTE	KG/PALLET KG/PALLET MÈTRES/PALETTE
60X120	2	1.44	35.13	32	46.08	1124

Para más información técnica, especificaciones e imágenes visite nuestra web y busque: Jadore
El embalaje de los artículos está sujeto a variaciones, para obtener el dato exacto y actual se recomienda consultar la web.
For more technical information, specifications and images, visit our website and search: Jadore
The packing of our items is subject to variations. To get the most accurate and updated information, we recommend to check the website.
Pour plus d'informations techniques, de spécifications et de visuels, visitez notre site web et recherchez : Jadore
L'emballage des articles est sujet à variation, pour obtenir les données exactes et actuelles il est recommandé de consulter notre site web.



TAJ MAHAL POL RECT
120 X 120 / 48" X 48" P06/M



TAJ MAHAL MATT RECT
60 X 120 / 24" X 48" R60/M

TAJ MAHAL POL RECT
60 X 120 / 24" X 48" J18/M

VARIACIÓN DE DISEÑO · GRAPHIC FACES

120X120 - 6 PIEZAS/6 PIECES/6 PIÈCES
60X120 - 12 PIEZAS/12 PIECES/12 PIÈCES

RODAPIÉS · SKIRTING BOARDS

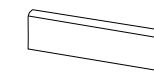

ROD. TAJ MAHAL POL.
75 X 60 / 3" X 24" K29/P



TAJ MAHAL POL RECT 60X120/TAJ MAHAL POL RECT 120X120/WOOD MATT RECT 60X120

CARACTERÍSTICAS TÉCNICAS · TECHNICAL CHARACTERISTICS

- P** PORCELÁNICO/PORCELAIN TILES
GRÉS CERÁME/FEINSTEINZEUG
- G** RECTIFICADO/RECTIFIED
RECTIFIÉ/KALIBRIERT
- V2** VARIACION LEVE/SLIGHT VARIATION
LÉGERÉ VARIATION/LEICHT FARBSPIEL
- ANTHIELO/FROST PROOF**
RÉSISTANT AU GEL/FROSTSCHUTZ

FORMATO SIZE FORMAT VERPACKUNG	PZS/CAJA TILES/BOX PIÈCES/BOITE	M²/CAJA SQM/BOX MÈTRES/BOITE	KG/CAJA KG/BOX KG/BOITE	CAJAS/PALLET BOXES/PALLET BOITES/PALETTE	M²/PALLET SQM/PALLET MÈTRES/PALETTE	KG/PALLET KG/PALLET MÈTRES/PALETTE
120X120	1	1.44	35.72	36	51.84	1286
60X120	2	1.44	35.03	32	46.08	1121

Para más información técnica, especificaciones e imágenes visite nuestra web y busque: Taj mahal
El embalaje de los artículos está sujeto a variaciones, para obtener el dato exacto y actual se recomienda consultar la web.
For more technical information, specifications and images, visit our website and search: Taj mahal
The packing of our items is subject to variations. To get the most accurate and updated information, we recommend to check the website.
Pour plus d'informations techniques, de spécifications et de visuels, visitez notre site web et recherchez : Taj mahal
L'emballage des articles est sujet à variation, pour obtenir les données exactes et actuelles il est recommandé de consulter notre site web.



SAINT LAURENT POL RECT
60 X 120 / 24" X 48" J89/M

RODAPIÉS · SKIRTING BOARDS

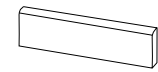

ROD. SAINT LAURENT POL.
7.5 X 60 / 3" X 24" K29/P

VARIACIÓN DE DISEÑO · GRAPHIC FACES

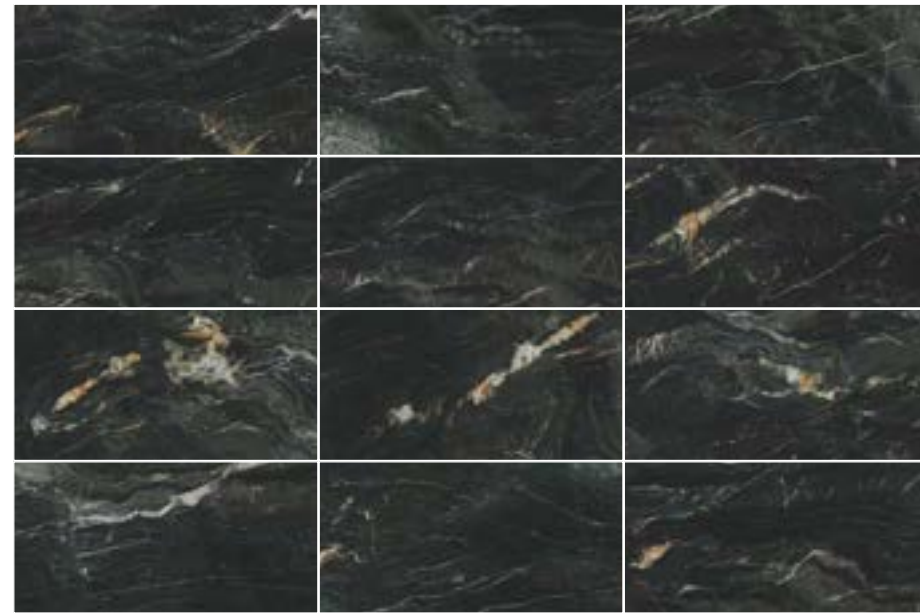

60X120 - 12 PIEZAS/12 PIECES/12 PIÈCES



SAINT LAURENT POL RECT. 60X120.

CARACTERÍSTICAS TÉCNICAS · TECHNICAL CHARACTERISTICS

- P** PORCELÁNICO/PORCELAIN TILES
GRÉS CERÁME/FEINSTEINZEUG
- G** GRANILLA PULIDA/GRAIN POLISHED
GRAIN POLI/TECHNISCHES POLIERTES FEINSTEINZEUG
- S** RECTIFICADO/RECTIFIED
RECTIFIÉ/KALIBRIERT
- V2** VARIACION LEVE/SLIGHT VARIATION
LÉGERÉ VARIATION/LEICHT FARBSPIEL
- S** ANTIHIELO/FROST PROOF
RÉSISTANT AU GEL/FROSTSCHUTZ
- RU4** USO RECOMENDADO/RECOMMENED USE - RU4

FORMATO SIZE FORMAT VERPACKUNG	PZS/CAJA TILES/BOX PIÈCES/BOITE	M²/CAJA SQM/BOX MÈTRES/BOITE	KG/CAJA KG/BOX KG/BOITE	CAJAS/PALLET BOXES/PALLET BOITES/PALETTE	M²/PALLET SQM/PALLET MÈTRES/PALETTE	KG/PALLET KG/PALLET MÈTRES/PALETTE
60X120	2	1.43	31.53	30	42.98	946

Para más información técnica, especificaciones e imágenes visite nuestra web y busque: Saint laurent
El embalaje de los artículos está sujeto a variaciones, para obtener el dato exacto y actual se recomienda consultar la web.

For more technical information, specifications and images, visit our website and search: Saint laurent
The packing of our items is subject to variations. To get the most accurate and updated information, we recommend to check the website.

Pour plus d'informations techniques, de spécifications et de visuels, visitez notre site web et recherchez : Saint laurent
L'emballage des articles est sujet à variation, pour obtenir les données exactes et actuelles il est recommandé de consulter notre site web.



VAN GOGH BRECCIA POL RECT
60 X 120 / 24" X 48" P34/M

RODAPIÉS · SKIRTING BOARDS

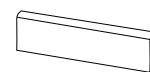

ROD. VAN GOGH POL.
7.5 X 60 / 3" X 24" K29/P

VARIACIÓN DE DISEÑO · GRAPHIC FACES



60X120 - 12 PIEZAS/12 PIECES/12 PIÈCES



VAN GOGH BRECCIA POL RECT. 60X120.

CARACTERÍSTICAS TÉCNICAS · TECHNICAL CHARACTERISTICS

- P** PORCELÁNICO/PORCELAIN TILES
GRÉS CERÁME/FEINSTEINZEUG
- G** GRANILLA PULIDA/GRAIN POLISHED
GRAIN POLI/TECHNISCHES POLIERTES FEINSTEINZEUG
- S** RECTIFICADO/RECTIFIED
RECTIFIÉ/KALIBRIERT
- V2** VARIACION LEVE/SLIGHT VARIATION
LÉGERÉ VARIATION/LEICHT FARBSPIEL
- S** ANTIHIELO/FROST PROOF
RÉSISTANT AU GEL/FROSTSCHUTZ
- RU4** USO RECOMENDADO/RECOMMENED USE - RU4

FORMATO SIZE FORMAT VERPACKUNG	PZS/CAJA TILES/BOX PIÈCES/BOITE	M²/CAJA SQM/BOX MÈTRES/BOITE	KG/CAJA KG/BOX KG/BOITE	CAJAS/PALLET BOXES/PALLET BOITES/PALETTE	M²/PALLET SQM/PALLET MÈTRES/PALETTE	KG/PALLET KG/PALLET MÈTRES/PALETTE
60X120	2	1.44	34.84	32	46.08	1115

Para más información técnica, especificaciones e imágenes visite nuestra web y busque: Van gogh
El embalaje de los artículos está sujeto a variaciones, para obtener el dato exacto y actual se recomienda consultar la web.

For more technical information, specifications and images, visit our website and search: Van gogh
The packing of our items is subject to variations. To get the most accurate and updated information, we recommend to check the website.

Pour plus d'informations techniques, de spécifications et de visuels, visitez notre site web et recherchez : Van gogh
L'emballage des articles est sujet à variation, pour obtenir les données exactes et actuelles il est recommandé de consulter notre site web.

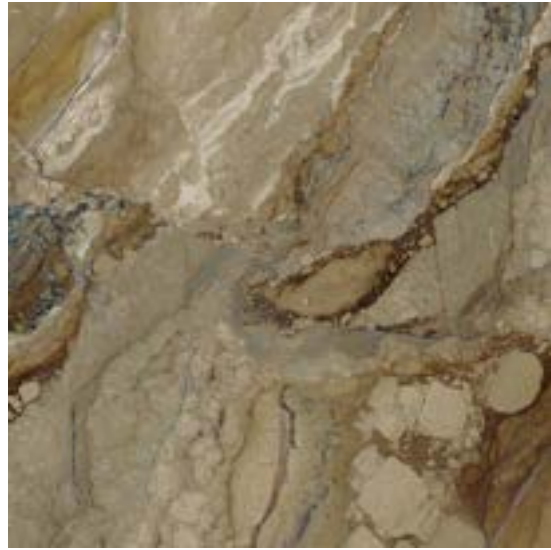

REX BROWN POLISHED RECT.
120 X 120 / 48" X 48"

P52/M



REX BROWN POLISHED RECT.
60 X 120 / 24" X 48"

P34/M

RODAPIÉS · SKIRTING BOARDS



ROD. REX BROWN POL.
75 X 60 / 3" X 24" K29/P

VARIACIÓN DE DISEÑO · GRAPHIC FACES

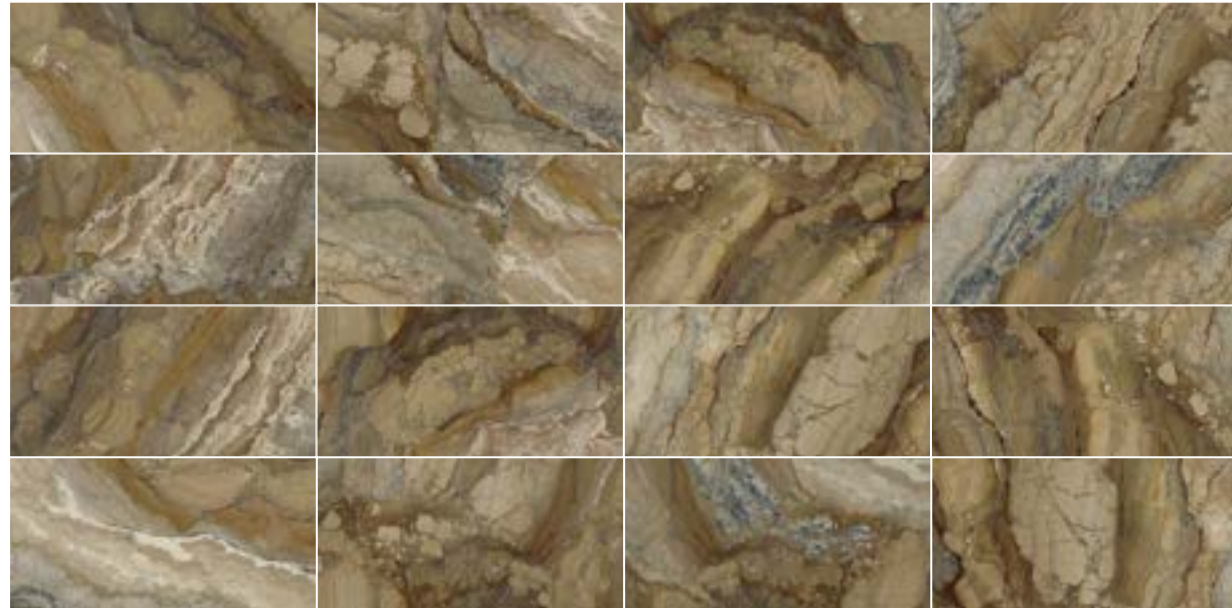

120X120 - 8 PIEZAS / 8 PIECES / 8 PIÈCES
60X120 - 16 PIEZAS / 16 PIECES / 16 PIÈCES

CARACTERÍSTICAS TÉCNICAS · TECHNICAL CHARACTERISTICS

- P** PORCELÁNICO / PORCELAIN TILES
GRÉS CERÁME / FEINSTEINZEUG
- V2** VARIACION LEVE / SLIGHT VARIATION
LÉGERE VARIATION / LEICHT FARBSPIEL
- G** GRANILLA PULIDA / GRAIN POLISHED
GRAIN POLI / TECHNISCHES POLIERTES FEINSTEINZEUG
- S** RECTIFICADO / RECTIFIED
RECTIFIÉ / KALIBRIERT
- RU4** USO RECOMENDADO / RECOMMENED USE - RU4

FORMATO SIZE FORMAT VERPACKUNG	PZS/CAJA TILES/BOX PIÈCES/BOITE	M²/CAJA SQM/BOX MÈTRES/BOITE	KG/CAJA KG/BOX KG/BOITE	CAJAS/PALLET BOXES/PALLET BOITES/PALETTE	M²/PALLET SQM/PALLET MÈTRES/PALETTE	KG/PALLET KG/PALLET MÈTRES/PALETTE
120X120	1	1.44	36.19	36	51.84	1303
60X120	2	1.44	35.78	32	46.08	1145

Para más información técnica, especificaciones e imágenes visite nuestra web y busque: Rex
El embalaje de los artículos está sujeto a variaciones, para obtener el dato exacto y actual se recomienda consultar la web.
For more technical information, specifications and images, visit our website and search: Rex
The packing of our items is subject to variations. To get the most accurate and updated information, we recommend to check the website.
Pour plus d'informations techniques, de spécifications et de visuels, visitez notre site web et recherchez : Rex
L'emballage des articles est sujet à variation, pour obtenir les données exactes et actuelles il est recommandé de consulter notre site web.



REX BROWN POLISHED RECT. 120X120



ANTI-SLIP KOEN CENERE MATT RECT 20X120 REX BROWN POLISHED RECT. 60X120



RU4 SILVER GREY POL RECT
120 X 120 / 48" X 48"

P06/M

M **RU8** SILVER GREY MATT RECT
60 X 120 / 24" X 48" R60/M

RU4 SILVER GREY POL RECT
60 X 120 / 24" X 48" J18/M

VARIACIÓN DE DISEÑO · GRAPHIC FACES



120X120 - 8 PIEZAS/8 PIECES/8 PIÈCES
60X120 - 16 PIEZAS/16 PIECES/16 PIÈCES

RODAPIÉS · SKIRTING BOARDS

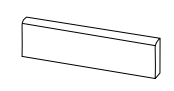

M ROD. MATT
75 X 60 / 3" X 24" K24/P

RU4 ROD. POL.
75 X 60 / 3" X 24" K29/P



SILVER GREY POL RECT 60X120/SILVER GREY POL RECT 120X120/HARLEQUIN GRAPHITE 10X20

CARACTERÍSTICAS TÉCNICAS · TECHNICAL CHARACTERISTICS

- P** PORCELÁNICO/PORCELAIN TILES
GRÈS CERÁME/FEINSTEINZEUG
- V2** VARIACION LEVE/SLIGHT VARIATION
LÉGERÉ VARIATION/LEICHT FARBSPIEL
- RU4** RECTIFICADO/RECTIFIED
RECTIFIÉ/KALIBRIERT
- SNOW** ANTIHIELO/FROST PROOF
RÉSISTANT AU GEL/FROSTSCHUTZ

FORMATO SIZE FORMAT VERPACKUNG	PZS/CAJA TILES/BOX PIÈCES/BOITE	M ² /CAJA SQM/BOX MÈTRES/BOITE	KG/CAJA KG/BOX KG/BOITE	CAJAS/PALLET BOXES/PALLET BOITES/PALETTE	M ² /PALLET SQM/PALLET MÈTRES/PALETTE	KG/PALLET KG/PALLET MÈTRES/PALETTE
120X120	1	1.44	37.03	36	51.84	1333
60X120	2	1.44	34.41	32	46.08	1101

Para más información técnica, especificaciones e imágenes visite nuestra web y busque: Silver grey
El embalaje de los artículos está sujeto a variaciones, para obtener el dato exacto y actual se recomienda consultar la web.
For more technical information, specifications and images, visit our website and search: Silver grey
The packing of our items is subject to variations. To get the most accurate and updated information, we recommend to check the website.
Pour plus d'informations techniques, de spécifications et de visuels, visitez notre site web et recherchez: Silver grey
L'emballage des articles est sujet à variation, pour obtenir les données exactes et actuelles il est recommandé de consulter notre site web.



M **RU5** STATUARY VENATO MATT RECT
120 X 120 / 48" X 48" **N31/M**

M **RU5** STATUARY VENATO MATT RECT
60 X 120 / 24" X 48" **R60/M**

M **C2** **RU5** STATUARY VENATO C2 RECT
120 X 120 / 48" X 48" **N34/M**

M **C2** **RU5** STATUARY VENATO C2 RECT
60 X 120 / 24" X 48" **N67/M**

E **RU4** STATUARY VENATO POL. RECT
120 X 120 / 48" X 48" **P06/M**

E **RU4** STATUARY VENATO POL. RECT
60 X 120 / 24" X 48" **J18/M**



E DECOR SET(2) SAUVAGE POL. RECT
60 X 120 / 24" X 48" **K68/P**



M **RU5** STATUARY VENATO MATT RECT.
60 X 60 / 24" X 24" **P07/M**

M **C2** **RU5** STATUARY VENATO C2 RECT.
60 X 60 / 24" X 24" **N18/M**

E **RU4** STATUARY VENATO POL. RECT.
60 X 60 / 24" X 24" **N29/M**

* REFERENCIAS MATE DISPONIBLE EN C2 BAJO PEDIDO
MATT FINISH AVAILABLE IN C2 UNDER SPECIAL ORDER

120 X 120 / 48" X 48" **N34/M**
60 X 120 / 24" X 48" **N67/M**
60 X 60 / 24" X 24" **N18/M**

RODAPIÉS · SKIRTING BOARDS



M ROD. STATUARY VENATO MATT
7.5 X 60 / 3" X 24" **K24/P**

E ROD. STATUARY VENATO POL.
7.5 X 60 / 3" X 24" **K29/P**



STATUARY VENATO POL. RECT 120X120/STATUARY VENATO POL. RECT 60X120.
DECOR SET(2) SAUVAGE POL. RECT 60X120



STATUARY VENATO MATT RECT 120X120/STATUARY VENATO MATT RECT 60X120

VARIACIÓN DE DISEÑO · GRAPHIC FACES



120X120 - 6 PIEZAS/6 PIECES/6 PIÈCES
60X120 - 12 PIEZAS/12 PIECES/12 PIÈCES
60X60 - 24 PIEZAS/24 PIECES/24 PIÈCES

CARACTERÍSTICAS TÉCNICAS · TECHNICAL CHARACTERISTICS

P PORCELÁNICO / PORCELAIN TILES
GRÉS CERÁME / FEINSTEINZEUG

V2 VARIACION LEVE / SLIGHT VARIATION
LÉGERE VARIATION / LEICHT FARBSPIEL

RE RECTIFICADO / RECTIFIED
RECTIFIÉ / KALIBRIERT

SN ANTIHIELO / FROST PROOF
RÉSISTANT AU GEL / FROSTSCHUTZ

FORMATO SIZE FORMAT VERPACKUNG	PZS/CAJA TILES/BOX PIÈCES/BOITE	M ² /CAJA SQM/BOX MÈTRES/BOITE	KG/CAJA KG/BOX KG/BOITE	CAJAS/PALLET BOXES/PALLET BOITES/PALETTE	M ² /PALLET SQM/PALLET MÈTRES/PALETTE	KG/PALLET KG/PALLET MÈTRES/PALETTE
120X120	1	1.44	38.50	36	51.84	1386
60X120	2	1.44	34.56	30	43.20	1037
60X60	4	1.44	32.37	30	43.20	971

Para más información técnica, especificaciones e imágenes visite nuestra web y busque: Statuary venato
El embalaje de los artículos está sujeto a variaciones, para obtener el dato exacto y actual se recomienda consultar la web.

For more technical information, specifications and images, visit our website and search: Statuary venato
The packing of our items is subject to variations. To get the most accurate and updated information, we recommend to check the website.

Pour plus d'informations techniques, de spécifications et de visuels, visitez notre site web et recherchez: Statuary venato
L'emballage des articles est sujet à variation, pour obtenir les données exactes et actuelles il est recommandé de consulter notre site web.

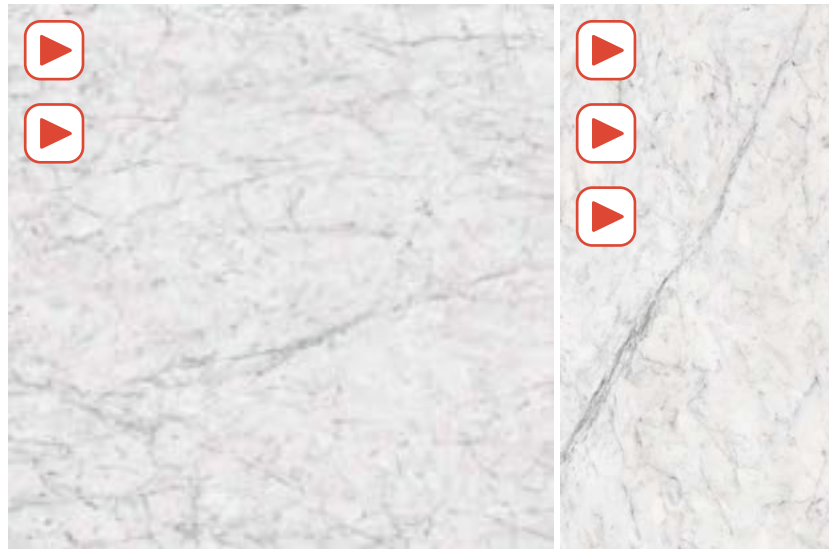

M **RU5** LUCE MATT RECT. 120 X 120 / 48" X 48" **N31/M** **M** **RU5** LUCE MATT RECT. 60 X 120 / 24" X 48"

M **C2** **RU5** LUCE C2 RECT. 120 X 120 / 48" X 48" **N34/M** **M** **C2** **RU5** LUCE C2 RECT. 60 X 120 / 24" X 48" **N67/M**

E **RU4** VITA POLISHED RECT. 120 X 120 / 48" X 48" **P06/M** **E** **RU4** VITA POLISHED RECT. 60 X 120 / 24" X 48" **J18/M**

M **C3** **R11** **RU5** NUOVA STRU RECT. 60 X 120 / 24" X 48" **N74/M**

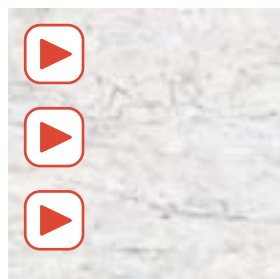

M **RU5** LUCE MATT RECT. 60 X 60 / 24" X 24" **P07/M** **M** **RU5** LUCE MATT RECT. 30 X 60 / 12" X 24" **P07/M**

M **C2** **RU5** LUCE C2 RECT. 60 X 60 / 24" X 24" **N18/M** **M** **C2** **RU5** LUCE C2 RECT. 30 X 60 / 12" X 24" **N18/M**

E **RU4** VITA POLISHED RECT. 60 X 60 / 24" X 24" **N29/M** **E** **RU4** VITA POLISHED RECT. 30 X 60 / 12" X 24" **N29/M**

M **C3** **R11** **RU5** NUOVA STRU RECT. 60 X 60 / 24" X 24" **N33/M** **M** **C3** **R11** **RU5** NUOVA STRU RECT. 30 X 60 / 12" X 24" **N33/M**

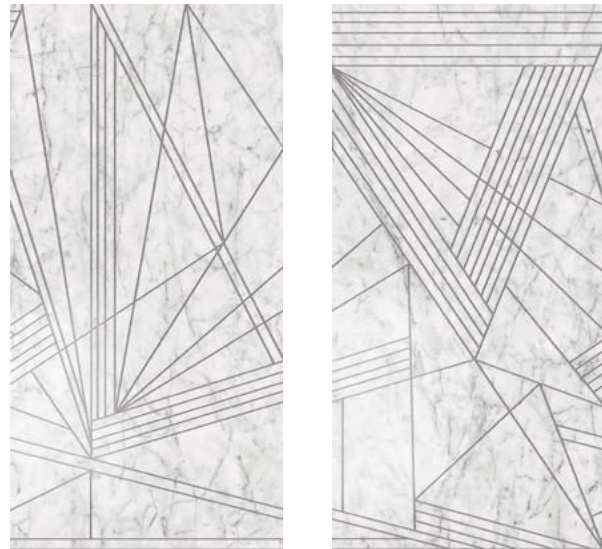

R60/M **E** **RU4** DECOR VITA I POLISHED RECT. 60 X 120 / 24" X 48" **K82/P** **E** **RU4** DECOR VITA II POLISHED RECT. 60 X 120 / 24" X 48" **K82/P**

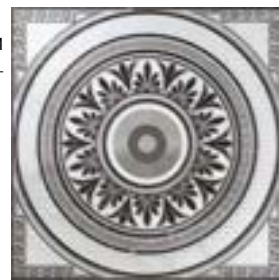

M **RU5** ROSETON NAVONA 60 X 60 / 24" X 24" **K77/P**



M **RU5** TACO NAVONA 10 X 10 / 4" X 4" **K28/P**



M **RU5** CENEFA NAVONA 10 X 60 / 4" X 24" **K61/P**



M **RU5** LUCE MATT RECT. 120 X 260 / 48" X 102" **J30/M**

E **RU4** VITA POL RECT. 120 X 260 / 48" X 102" **J31/M**

VARIACIÓN DE DISEÑO · GRAPHIC FACES



120X260 - 4 PIEZAS / 4 PIECES / 4 PIÈCES
120X120 - 8 PIEZAS / 8 PIECES / 8 PIÈCES
60X120 - 16 PIEZAS / 16 PIECES / 16 PIÈCES
60X60 - 32 PIEZAS / 32 PIECES / 32 PIÈCES
30X60 - 64 PIEZAS / 64 PIECES / 64 PIÈCES

* REFERENCIAS MATE DISPONIBLE EN C2 BAJO PEDIDO MATT FINISH AVAILABLE IN C2 UNDER SPECIAL ORDER

120 X 120 / 48" X 48" **N34/M**
 60 X 120 / 24" X 48" **N67/M**
 60 X 60 / 24" X 24" **N18/M**
 30 X 60 / 12" X 24" **N18/M**

MOSAICOS · MOSAICS **P** **RU4** **V2**



RU4 MALLA VITA POLISHED 30 X 30(5 X 5) / 12" X 12" **K30/P**

M **RU5** MALLA LUCE MATT 30 X 30(5 X 5) / 12" X 12" **K01/P**

PELDAÑOS · STEPS **M** **R11** **V2** **RU5**

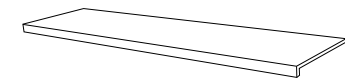

C3 **R11** PELDAÑO RECTO ANT. C3 NUOVA 33 X 120 / 13" X 48" **K91/P**



REMATE PELD. RECTO NUOVA 3.2 X 33 / 1.5" X 13" **K36/P**

RODAPIÉS · SKIRTING BOARDS **P** **V2**



M **RU5** ROD. LUCE MATT 7.5 X 60 / 3" X 24" **K24/P**

E **RU4** ROD. VITA POL. 7.5 X 60 / 3" X 24" **K29/P**



M **RU5** TABICA NUOVA 15 X 120 / 6" X 48" **K11/P**

CARACTERÍSTICAS TÉCNICAS · TECHNICAL CHARACTERISTICS

- P** PORCELÁNICO / PORCELAIN TILES / GRÉS CERÁME / FEINSTEINZEUG
- V2** VARIACION LEVE / SLIGHT VARIATION / LÉGERÉ VARIATION / LEICHT FARBSPIEL
- RECTIFICADO / RECTIFIED / RECTIFIÉ / KALIBRIERT**
- ANTIHIELO / FROST PROOF / RÉSISTANT AU GEL / FROSTSCHUTZ**

FORMATO SIZE / FORMAT / VERPACKUNG	PZS/CAJA / TILES/BOX / PIÈCES/BOITE	M²/CAJA / SQM/BOX / MÈTRES/BOITE	KG/CAJA / KG/BOX / KG/BOITE	CAJAS/PALLET / BOXES/PALLET / BOITES/PALETTE	M²/PALLET / SQM/PALLET / MÈTRES/PALETTE	KG/PALLET / KG/PALLET / MÈTRES/PALETTE
120X260	1	3.12	52.50	13	40.56	683
120X120	1	1.44	37.08	36	51.84	1335
10X10	36	0.36	7.81	100	36.00	781
10X60	6	0.36	7.81	75	27.00	586
60X120	2	1.43	33.97	30	42.98	1019
60X60	4	1.44	31.70	30	43.20	951
30X60	6	1.08	24.35	48	51.84	1169

Para más información técnica, especificaciones e imágenes visite nuestra web y busque: Vita
 El embalaje de los artículos está sujeto a variaciones, para obtener el dato exacto y actual se recomienda consultar la web.
 For more technical information, specifications and images, visit our website and search: Vita
 The packing of our items is subject to variations. To get the most accurate and updated information, we recommend to check the website.
 Pour plus d'informations techniques, de spécifications et de visuels, visitez notre site web et recherchez : Vita
 L'emballage des articles est sujet à variation, pour obtenir les données exactes et actuelles il est recommandé de consulter notre site web.



M **RU5** INVISIBLE GOLD MATT RECT
120 X 120 / 48" X 48" **N31/M**

M **C2** **RU5** INVISIBLE GOLD C2 RECT
120 X 120 / 48" X 48" **N34/M**

E **RU4** INVISIBLE GOLD POL. RECT
120 X 120 / 48" X 48" **P06/M**



M **RU5** INVISIBLE GOLD MATT RECT
60 X 120 / 24" X 48" **R60/M**

M **C2** **RU5** INVISIBLE GOLD C2 RECT
60 X 120 / 24" X 48" **N67/M**

E **RU4** INVISIBLE GOLD POL. RECT
60 X 120 / 24" X 48" **J18/M**



M **RU5** INVISIBLE GOLD MATT RECT.
60 X 60 / 24" X 24" **P07/M**

M **C2** **RU5** INVISIBLE GOLD C2 RECT.
60 X 60 / 24" X 24" **N18/M**

E **RU4** INVISIBLE GOLD POL. RECT.
60 X 60 / 24" X 24" **N29/M**



M **RU5** INVISIBLE GOLD MATT RECT.
30 X 60 / 12" X 24" **P07/M**

M **C2** **RU5** INVISIBLE GOLD C2 RECT.
30 X 60 / 12" X 24" **N18/M**

E **RU4** INVISIBLE GOLD POL. RECT.
30 X 60 / 12" X 24" **N29/M**



M **RU5** OROBICO GRIGIO MATT RECT
120 X 120 / 48" X 48" **N31/M**

M **C2** **RU5** OROBICO GRIGIO C2 RECT
120 X 120 / 48" X 48" **N34/M**

E **RU4** OROBICO GRIGIO POL. RECT
120 X 120 / 48" X 48" **P06/M**



M **RU5** OROBICO GRIGIO MATT RECT
60 X 120 / 24" X 48" **R60/M**

M **C2** **RU5** OROBICO GRIGIO C2 RECT
60 X 120 / 24" X 48" **N67/M**

E **RU4** OROBICO GRIGIO POL. RECT
60 X 120 / 24" X 48" **J18/M**



E **RU4** INVISIBLE GOLD POL RECT
120 X 260 / 48" X 102" **J31/M**

VARIACIÓN DE DISEÑO · GRAPHIC FACES



120X120 - 6 PIEZAS/6 PIECES/6 PIÈCES
60X120 - 12 PIEZAS/12 PIECES/12 PIÈCES

VARIACIÓN DE DISEÑO · GRAPHIC FACES

- 120X260 - 4 PIEZAS/4 PIECES/4 PIÈCES
- 120X120 - 8 PIEZAS/8 PIECES/8 PIÈCES
- 60X120 - 16 PIEZAS/16 PIECES/16 PIÈCES
- 60X60 - 32 PIEZAS/32 PIECES/32 PIÈCES
- 30X60 - 64 PIEZAS/64 PIECES/64 PIÈCES

* REFERENCIAS MATE DISPONIBLE EN C2 BAJO PEDIDO
MATT FINISH AVAILABLE IN C2 UNDER SPECIAL ORDER

120 X 120 / 48" X 48"	N34/M
60 X 120 / 24" X 48"	N67/M
60 X 60 / 24" X 24"	N18/M
30 X 60 / 12" X 24"	N18/M

* REFERENCIAS MATE DISPONIBLE EN C2 BAJO PEDIDO
MATT FINISH AVAILABLE IN C2 UNDER SPECIAL ORDER

120 X 120 / 48" X 48"	N34/M
60 X 120 / 24" X 48"	N67/M
60 X 60 / 24" X 24"	N18/M
30 X 60 / 12" X 24"	N18/M



TRAVERTINO SILVER POL. RECT
120 X 120 / 48" X 48"

P06/M

TRAVERTINO SILVER MATT RECT
60 X 120 / 24" X 48"

R60/M

TRAVERTINO SILVER C2 RECT
60 X 120 / 24" X 48"

N67/M

TRAVERTINO SILVER POL. RECT
60 X 120 / 24" X 48"

J18/M

TRAVERTINO SILVER STRU RECT
60 X 120 / 24" X 48"

N74/M



TRAVERTINO BRESCIA POL. RECT
120 X 120 / 48" X 48"

P06/M

TRAVERTINO BRESCIA MATT RECT
60 X 120 / 24" X 48"

R60/M

TRAVERTINO BRESCIA C2 RECT
60 X 120 / 24" X 48"

N67/M

TRAVERTINO BRESCIA POL. RECT
60 X 120 / 24" X 48"

J18/M

TRAVERTINO BRESCIA STRU RECT
60 X 120 / 24" X 48"

N74/M



TRAVERTINO SILVER MATT RECT.
60 X 60 / 24" X 24"

P07/M

TRAVERTINO SILVER C2 RECT.
60 X 60 / 24" X 24"

N18/M

TRAVERTINO SILVER POL. RECT.
60 X 60 / 24" X 24"

N29/M

TRAVERTINO SILVER STRU RECT.
60 X 60 / 24" X 24"

N33/M



TRAVERTINO SILVER MATT RECT.
30 X 60 / 12" X 24"

P07/M

TRAVERTINO SILVER C2 RECT.
30 X 60 / 12" X 24"

N18/M

TRAVERTINO SILVER POL. RECT.
30 X 60 / 12" X 24"

N29/M

TRAVERTINO SILVER STRU RECT.
30 X 60 / 12" X 24"

N33/M



TRAVERTINO BRESCIA MATT RECT.
60 X 60 / 24" X 24"

P07/M

TRAVERTINO BRESCIA C2 RECT.
60 X 60 / 24" X 24"

N18/M

TRAVERTINO BRESCIA POL. RECT.
60 X 60 / 24" X 24"

N29/M

TRAVERTINO BRESCIA STRU RECT.
60 X 60 / 24" X 24"

N33/M



TRAVERTINO BRESCIA MATT RECT.
30 X 60 / 12" X 24"

P07/M

TRAVERTINO BRESCIA C2 RECT.
30 X 60 / 12" X 24"

N18/M

TRAVERTINO BRESCIA POL. RECT.
30 X 60 / 12" X 24"

N29/M

TRAVERTINO BRESCIA STRU RECT.
30 X 60 / 12" X 24"

N33/M



PELDAÑOS · STEPS

DISPONIBLE EN TODOS LOS COLORES / AVAILABLE IN ALL COLORS

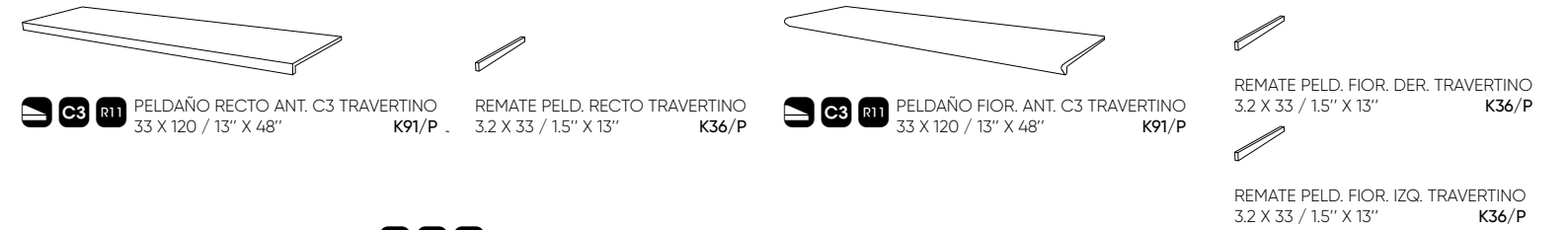

RODAPIÉS · SKIRTING BOARDS

DISPONIBLE EN TODOS LOS COLORES / AVAILABLE IN ALL COLORS

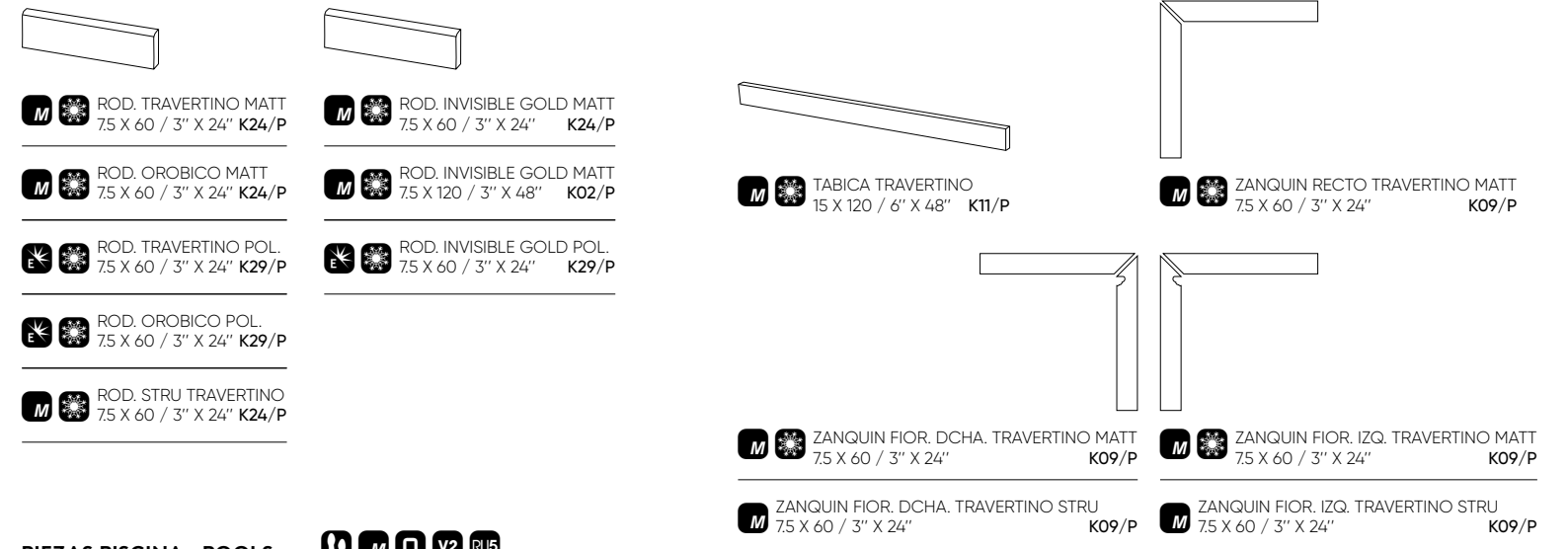

PIEZAS PISCINA · POOLS

DISPONIBLE EN TODOS LOS COLORES / AVAILABLE IN ALL COLORS

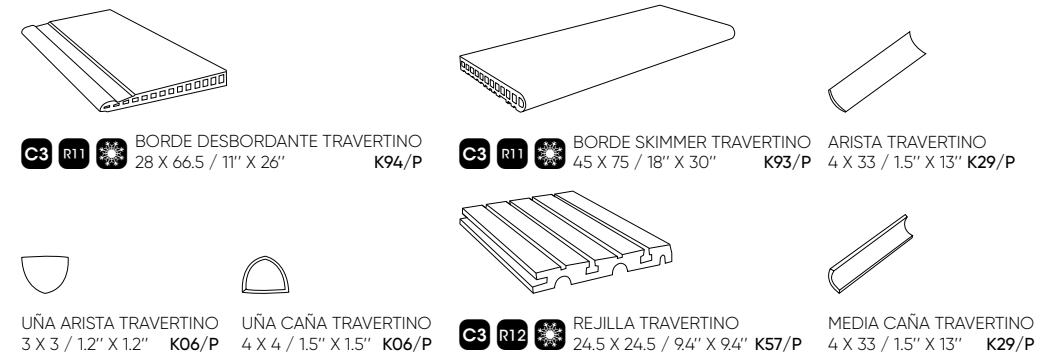

VARIACIÓN DE DISEÑO · GRAPHIC FACES

INVISIBLE
120X120 - 8 PIEZAS/8 PIECES/8 PIÈCES
60X120 - 16 PIEZAS/16 PIECES/16 PIÈCES
60X60 - 32 PIEZAS/32 PIECES/32 PIÈCES
30X60 - 64 PIEZAS/64 PIECES/64 PIÈCES

OROBICO
120X120 - 6 PIEZAS/6 PIECES/6 PIÈCES
60X120 - 12 PIEZAS/12 PIECES/12 PIÈCES

TRAVERTINO
120X120 - 3 PIEZAS/3 PIECES/3 PIÈCES
60X120 - 6 PIEZAS/6 PIECES/6 PIÈCES
60X60 - 12 PIEZAS/12 PIECES/12 PIÈCES
30X60 - 24 PIEZAS/24 PIECES/24 PIÈCES

CARACTERÍSTICAS TÉCNICAS · TECHNICAL CHARACTERISTICS

P	PORCELÁNICO/PORCELAIN TILES GRÈS CERÁME/FEINSTEINZEUG	V2	VARIACION LEVE/SLIGHT VARIATION LÉGERÉ VARIATION/LEICHT FARBSPIEL
R	RECTIFICADO/RECTIFIED RECTIFIÉ/KALIBRIERT	F	ANTIHIELO/FROST PROOF RÉSISTANT AU GEL/FROSTSCHUTZ

FORMATO SIZE FORMAT VERPACKUNG	PZS/CAJA TILES/BOX PIÈCES/BOITE	M²/CAJA SQM/BOX MÈTRES/BOITE	KG/CAJA KG/BOX KG/BOITE	CAJAS/PALLET BOXES/PALLET BOITES/PALETTE	M²/PALLET SQM/PALLET MÈTRES/PALETTE	KG/PALLET KG/PALLET MÈTRES/PALETTE
120X260	1	3.12	52.50	13	40.56	683
120X120	1	1.44	39.17	36	51.84	1410
60X120	2	1.44	34.09	32	46.08	1091
60X60	4	1.44	31.20	30	43.20	936
30X60	6	1.08	23.55	48	51.84	1131

Para más información técnica, especificaciones e imágenes visite nuestra web y busque: Wabi sabi
El embalaje de los artículos está sujeto a variaciones, para obtener el dato exacto y actual se recomienda consultar la web.

For more technical information, specifications and images, visit our website and search: Wabi sabi
The packing of our items is subject to variations. To get the most accurate and updated information, we recommend to check the website.

Pour plus d'informations techniques, de spécifications et de visuels, visitez notre site web et recherchez: Wabi sabi
L'emballage des articles est sujet à variation, pour obtenir les données exactes et actuelles il est recommandé de consulter notre site web.



M **RU5** MANDALAY WHITE RECT.
80 X 80 / 32" X 32" **R41/M**



M **RU5** MANDALAY WHITE MATT RECT
60 X 120 / 24" X 48" **R60/M**



M **RU5** MANDALAY WHITE RECT.
60 X 60 / 24" X 24" **P07/M**



M **RU5** MANDALAY WHITE RECT.
30 X 60 / 12" X 24" **P07/M**

E **RU4** MANDALAY WHITE POL. RECT
60 X 120 / 24" X 48" **J18/M**



M **RU5** ROSETON MANDALAY
60 X 60 / 24" X 24" **K76/P**



M **RU5** CENEFA MANDALAY
60 X 60 / 24" X 24" **K76/P**



LISTELO MANDALAY
15 X 60 / 6" X 24" **K63/P**



TACO MANDALAY
15 X 15 / 6" X 6" **K29/P**

VARIACIÓN DE DISEÑO · GRAPHIC FACES

- 60X120 - 9 PIEZAS/9 PIECES/9 PIÈCES
- 59X119 - 9 PIEZAS/9 PIECES/9 PIÈCES
- 80X80 - 9 PIEZAS/9 PIECES/9 PIÈCES
- 60X60 - 12 PIEZAS/12 PIECES/12 PIÈCES
- 30X60 - 24 PIEZAS/24 PIECES/24 PIÈCES

RODAPIÉS · SKIRTING BOARDS



M ROD. MANDALAY WHITE
7.5 X 80 / 3" X 32" **K21/P**

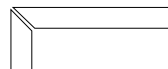

M ROD. MANDALAY WHITE
7.5 X 60 / 3" X 24" **K24/P**



M ZANQUIN RECTO
7.5 X 60 / 3" X 24" **K09/P**

E ROD. MANDALAY WHITE POL.
7.5 X 60 / 3" X 24" **K29/P**

PELDAÑOS · STEPS

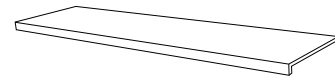

PELDAÑO RECTO MANDALAY
33 X 120 / 13" X 48" **K91/P**



ROSETON MANDALAY 60X60, CENEFA MANDALAY 60X60, LISTELO MANDALAY 15X60, TACO MANDALAY 15X15, ROSETON MANDALAY 60X60.

CARACTERÍSTICAS TÉCNICAS · TECHNICAL CHARACTERISTICS

- P** PORCELÁNICO/PORCELAIN TILES
GRÈS CERÁME/FEINSTEINZEUG
- V2** VARIACION LEVE/SLIGHT VARIATION
LÉGERE VARIATION/LEICHT FARBSPIEL
- RE** RECTIFICADO/RECTIFIED
RECTIFIÉ/KALIBRIERT
- SN** ANTIHIELO/FROST PROOF
RÉSISTANT AU GEL/FROSTSCHUTZ

FORMATO SIZE FORMAT VERPACKUNG	PZS/CAJA TILES/BOX PIÈCES/BOITE	M²/CAJA SQM/BOX MÈTRES/BOITE	KG/CAJA KG/BOX KG/BOITE	CAJAS/PALLET BOXES/PALLET BOITES/PALETTE	M²/PALLET SQM/PALLET MÈTRES/PALETTE	KG/PALLET KG/PALLET MÈTRES/PALETTE
80X80	2	1.28	29.98	44	56.32	1319
60X120	2	1.44	34.41	32	46.08	1101
60X60	4	1.44	34.07	28	40.32	954
30X60	6	1.08	23.74	40	43.20	950

Para más información técnica, especificaciones e imágenes visite nuestra web y busque: Mandalay
El embalaje de los artículos está sujeto a variaciones, para obtener el dato exacto y actual se recomienda consultar la web.

For more technical information, specifications and images, visit our website and search: Mandalay
The packing of our items is subject to variations. To get the most accurate and updated information, we recommend to check the website.

Pour plus d'informations techniques, de spécifications et de visuels, visitez notre site web et recherchez: Mandalay
L'emballage des articles est sujet à variation, pour obtenir les données exactes et actuelles il est recommandé de consulter notre site web.



M R10 RU5 MARE DI SABBIA BEIGE MATT RECT
80 X 80 / 32" X 32" **R41/M**



M R10 RU5 MARE DI SABBIA BEIGE MATT RECT
60 X 120 / 24" X 48" **J55/M**

E RU4 MARE DI SABBIA BEIGE POL RECT
60 X 120 / 24" X 48" **P34/M**



M R10 RU5 MARE DI SABBIA GREIGE MATT RECT
60 X 120 / 24" X 48" **J55/M**

E RU4 MARE DI SABBIA GREIGE POL RECT
60 X 120 / 24" X 48" **P34/M**

RODAPÍÉS · SKIRTING BOARDS

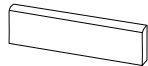

M ROD. MARE DI SABBIA MATT
7.5 X 60 / 3" X 24" **K24/P**

E ROD. MARE DI SABBIA POL.
7.5 X 60 / 3" X 24" **K29/P**

CARACTERÍSTICAS TÉCNICAS · TECHNICAL CHARACTERISTICS

- P** PORCELÁNICO/PORCELAIN TILES
GRÈS CERÁME/FEINSTEINZEUG
- V2** VARIACION LEVE/ SLIGHT VARIATION
LÉGERÉ VARIATION/LEICHT FARBSPIEL
- RECTIFICADO/RECTIFIED**
RECTIFIÉ/KALIBRIERT
- ANTIHELIO/FROST PROOF**
RÉSISTANT AU GEL/FROSTSCHUTZ

FORMATO SIZE FORMAT VERPACKUNG	PZS/CAJA TILES/BOX PIÈCES/BOITE	M²/CAJA SQM/BOX MÈTRES/BOITE	KG/CAJA KG/BOX KG/BOITE	CAJAS/PALLET BOXES/PALLET BOITES/PALETTE	M²/PALLET SQM/PALLET MÈTRES/PALETTE	KG/PALLET KG/PALLET MÈTRES/PALETTE
80X80	2	1.28	30.52	44	56.32	1343
60X120	2	1.44	28.44	36	51.84	1024

Para más información técnica, especificaciones e imágenes visite nuestra web y busque: Mare di sabbia
El embalaje de los artículos está sujeto a variaciones, para obtener el dato exacto y actual se recomienda consultar la web.

For more technical information, specifications and images, visit our website and search: Mare di sabbia
The packing of our items is subject to variations. To get the most accurate and updated information, we recommend to check the website.

Pour plus d'informations techniques, de spécifications et de visuels, visitez notre site web et recherchez : Mare di sabbia
L'emballage des articles est sujet à variation, pour obtenir les données exactes et actuelles il est recommandé de consulter notre site web.



VARIACIÓN DE DISEÑO · GRAPHIC FACES



60X120 - 12 PIEZAS/12 PIECES/12 PIÈCES

60X60 - 24 PIEZAS/24 PIECES/24 PIÈCES

80X80 - 6 PIEZAS/6 PIECES/6 PIÈCES

Capraia



CAPRAIA BIANCO POL. RECT.
80 X 80 / 32" X 32"

P45/M



CAPRAIA BIANCO POL RECT
60 X 120 / 24" X 48"

J18/M

VARIACIÓN DE DISEÑO · GRAPHIC FACES



80X80 - 12 PIEZAS/12 PIÈCES/12 PIÈCES
60X120 - 12 PIEZAS/12 PIÈCES/12 PIÈCES



RODAPIÉS · SKIRTING BOARDS

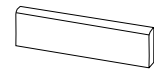

M ROD. CAPRAIA MATT
7.5 X 60 / 3" X 24" K24/P

E ROD. CAPRAIA POL.
7.5 X 80 / 3" X 32" K17/P

CARACTERÍSTICAS TÉCNICAS · TECHNICAL CHARACTERISTICS

- P** PORCELÁNICO/PORCELAIN TILES
GRÉS CERÁME/FEINSTEINZEUG
- V2** VARIACION LEVE/SLIGHT VARIATION
LÉGERÉ VARIATION/LEICHT FARBSPIEL
- E** ESMALTE PULIDO/GLAZE POLISHED SHINY
ÉMAIL POLI BRILLANT/HOCHGLANZ POLIERT
- F** ANTIHIELO/FROST PROOF
RÉSISTANT AU GEL/FROSTSCHUTZ
- R** RECTIFICADO/RECTIFIED
RECTIFIÉ/KALIBRIERT
- RU4** USO RECOMENDADO/RECOMMENED USE - RU4

FORMATO SIZE FORMAT VERPACKUNG	PZS/CAJA TILES/BOX PIÈCES/BOITE	M²/CAJA SQM/BOX MÈTRES/BOITE	KG/CAJA KG/BOX KG/BOITE	CAJAS/PALLET BOXES/PALLET BOITES/PALETTE	M²/PALLET SQM/PALLET MÈTRES/PALETTE	KG/PALLET KG/PALLET MÈTRES/PALETTE
80X80	2	1.28	28.55	42	53.76	1199
60X120	2	1.44	31.47	32	46.08	1007

Para más información técnica, especificaciones e imágenes visite nuestra web y busque: Capraia
El embalaje de los artículos está sujeto a variaciones, para obtener el dato exacto y actual se recomienda consultar la web.

For more technical information, specifications and images, visit our website and search: Capraia
The packing of our items is subject to variations. To get the most accurate and updated information, we recommend to check the website.

Pour plus d'informations techniques, de spécifications et de visuels, visitez notre site web et recherchez : Capraia
L'emballage des articles est sujet à variation, pour obtenir les données exactes et actuelles il est recommandé de consulter notre site web.



Nero marquina

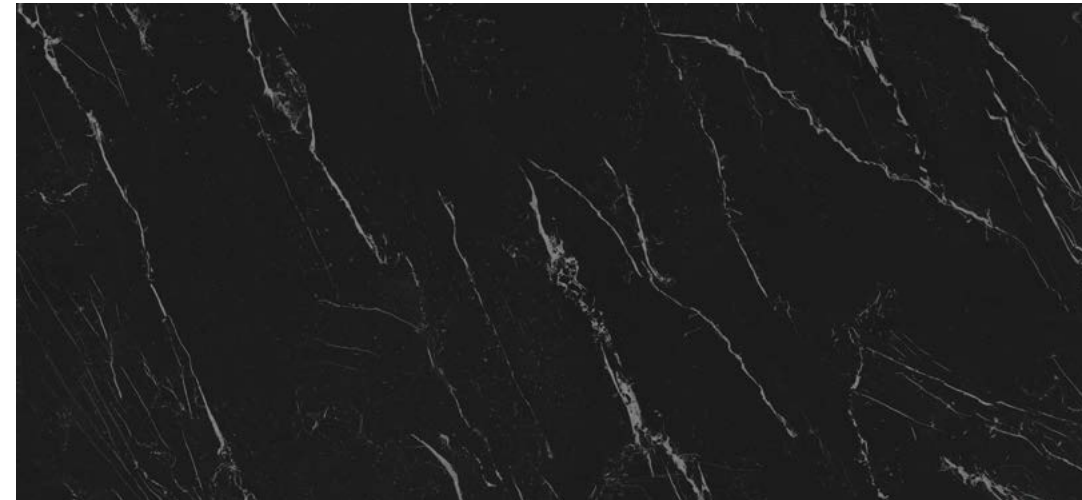

E NERO MARQUINA POL RECT
120 X 260 / 48" X 102"

J32/M



NERO MARQUINA POL. RECT
59 X 119 / 23" X 47"

N26/M

VARIACIÓN DE DISEÑO GRAPHIC FACES

120X260 - 3 PIEZAS/3 PIÈCES/3 PIÈCES
59X119 - 8 PIEZAS/8 PIÈCES/8 PIÈCES

MANDALAY
59X119 - 9 PIEZAS/9 PIÈCES/9 PIÈCES

RODAPIÉS · SKIRTING BOARDS



M ROD. NERO MARQUINA POL
7.5 X 59 / 3" X 23" K29/P

ROD. MANDALAY WHITE POL
7.5 X 59 / 3" X 23" K29/P



NERO MARQUINA POL. RECT. 59X119.

CARACTERÍSTICAS TÉCNICAS · TECHNICAL CHARACTERISTICS

- P** PORCELÁNICO/PORCELAIN TILES
GRÉS CERÁME/FEINSTEINZEUG
- V2** VARIACION LEVE/SLIGHT VARIATION
LÉGERÉ VARIATION/LEICHT FARBSPIEL
- E** GRANILLA PULIDA/GRAIN POLISHED
GRAIN POLI/TECHNISCHES POLIERTES FEINSTEINZEUG
- F** ANTIHIELO/FROST PROOF
RÉSISTANT AU GEL/FROSTSCHUTZ
- R** RECTIFICADO/RECTIFIED
RECTIFIÉ/KALIBRIERT
- RU4** USO RECOMENDADO/RECOMMENED USE - RU4

FORMATO SIZE FORMAT VERPACKUNG	PZS/CAJA TILES/BOX PIÈCES/BOITE	M²/CAJA SQM/BOX MÈTRES/BOITE	KG/CAJA KG/BOX KG/BOITE	CAJAS/PALLET BOXES/PALLET BOITES/PALETTE	M²/PALLET SQM/PALLET MÈTRES/PALETTE	KG/PALLET KG/PALLET MÈTRES/PALETTE
120X260	1	3.12	52.50	13	40.56	683
59X119	2	1.40	38.08	27	37.80	1028

Para más información técnica, especificaciones e imágenes visite nuestra web y busque: Nero marquina
El embalaje de los artículos está sujeto a variaciones, para obtener el dato exacto y actual se recomienda consultar la web.

For more technical information, specifications and images, visit our website and search: Nero marquina
The packing of our items is subject to variations. To get the most accurate and updated information, we recommend to check the website.

Pour plus d'informations techniques, de spécifications et de visuels, visitez notre site web et recherchez : Nero marquina
L'emballage des articles est sujet à variation, pour obtenir les données exactes et actuelles il est recommandé de consulter notre site web.

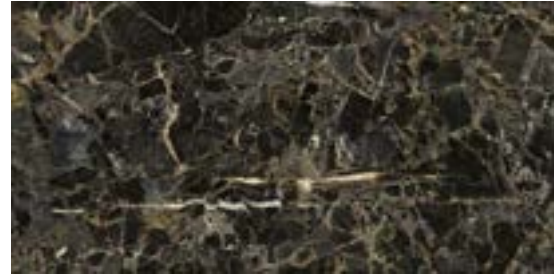

GOLDEN BLACK POL. RECT
60 X 120 / 24" X 48" P34/M

VARIACIÓN DE DISEÑO · GRAPHIC FACES

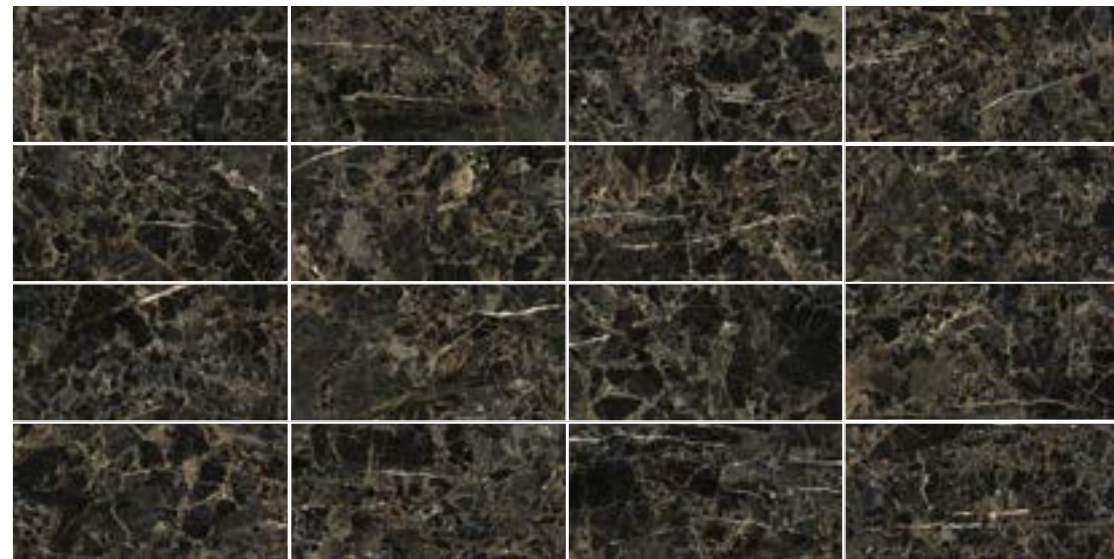

60X120 - 16 PIEZAS/16 PIECES/16 PIÈCES

RODAPIÉS · SKIRTING BOARDS



ROD. GOLDEN BLACK POL
75 X 60 / 3" X 24" K29/P

CARACTERÍSTICAS TÉCNICAS · TECHNICAL CHARACTERISTICS

- P** PORCELÁNICO / PORCELAIN TILES
GRÈS CERÁME / FEINSTEINZEUG
- G** GRANILLA PULIDA / GRAIN POLISHED
GRAIN POLI / TECHNISCHES POLIERTES FEINSTEINZEUG
- RECT** RECTIFICADO / RECTIFIED
RECTIFIÉ / KALIBRIERT
- V2** VARIACION LEVE / SLIGHT VARIATION
LÉGERÉ VARIATION / LEICHT FARBSPIEL
- ANTIFROST** ANTIHIELO / FROST PROOF
RÉSISTANT AU GEL / FROSTSCHUTZ
- RU4** USO RECOMENDADO / RECOMMENED USE - RU4

FORMATO SIZE FORMAT VERPACKUNG	PZS/CAJA TILES/BOX PIÈCES/BOITE	M²/CAJA SQM/BOX MÈTRES/BOITE	KG/CAJA KG/BOX KG/BOITE	CAJAS/PALLET BOXES/PALLET BOITES/PALETTE	M²/PALLET SQM/PALLET MÈTRES/PALETTE	KG/PALLET KG/PALLET MÈTRES/PALETTE
60X120	2	1.44	35.13	32	46.08	1124

Para más información técnica, especificaciones e imágenes visite nuestra web y busque: Golden black
El embalaje de los artículos está sujeto a variaciones, para obtener el dato exacto y actual se recomienda consultar la web.
For more technical information, specifications and images, visit our website and search: Golden black
The packing of our items is subject to variations. To get the most accurate and updated information, we recommend to check the website.
Pour plus d'informations techniques, de spécifications et de visuels, visitez notre site web et recherchez : Golden black
L'emballage des articles est sujet à variation, pour obtenir les données exactes et actuelles il est recommandé de consulter notre site web.



GOLDEN BLACK POL. RECT 60X120



M **RU5** GREEK CAPUCCINO MATT RECT
60 X 120 / 24" X 48" **R60/M**

E **RU4** GREEK CAPUCCINO POL RECT
60 X 120 / 24" X 48" **J18/M**

VARIACIÓN DE DISEÑO · GRAPHIC FACES



60X120 - 16 PIEZAS/16 PIECES/16 PIÈCES

CARACTERÍSTICAS TÉCNICAS · TECHNICAL CHARACTERISTICS

- P** PORCELÁNICO / PORCELAIN TILES
GRÈS CERÁME / FEINSTEINZEUG
- V2** VARIACION LEVE / SLIGHT VARIATION
LÉGERÉ VARIATION / LEICHT FARBSPIEL
- R** RECTIFICADO / RECTIFIED
RECTIFIÉ / KALIBRIERT
- S** ANTIHIELO / FROST PROOF
RÉSISTANT AU GEL / FROSTSCHUTZ

FORMATO SIZE FORMAT VERPACKUNG	PZS/CAJA TILES/BOX PIÈCES/BOITE	M²/CAJA SQM/BOX MÈTRES/BOITE	KG/CAJA KG/BOX KG/BOITE	CAJAS/PALLET BOXES/PALLET BOITES/PALETTE	M²/PALLET SQM/PALLET MÈTRES/PALETTE	KG/PALLET KG/PALLET MÈTRES/PALETTE
60X120	2	1.44	34.47	32	46.08	1103

Para más información técnica, especificaciones e imágenes visite nuestra web y busque: Greek capuccino
El embalaje de los artículos está sujeto a variaciones, para obtener el dato exacto y actual se recomienda consultar la web.

For more technical information, specifications and images, visit our website and search: Greek capuccino
The packing of our items is subject to variations. To get the most accurate and updated information, we recommend to check the website.

Pour plus d'informations techniques, de spécifications et de visuels, visitez notre site web et recherchez : Greek capuccino
L'emballage des articles est sujet à variation, pour obtenir les données exactes et actuelles il est recommandé de consulter notre site web.



GREEK CAPUCCINO MATT RECT: 60X120. GREEK CAPUCCINO POL. RECT: 60X120.



VARIACIÓN DE DISEÑO · GRAPHIC FACES

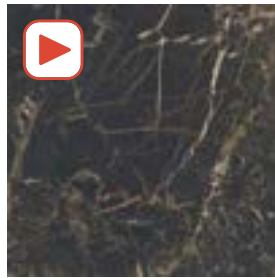

M **RU5** NIGHT LUX MATT RECT
60 X 120 / 24" X 48" **N10/M**

6 **RU4** NIGHT LUX POL. RECT
60 X 120 / 24" X 48" **J89/M**

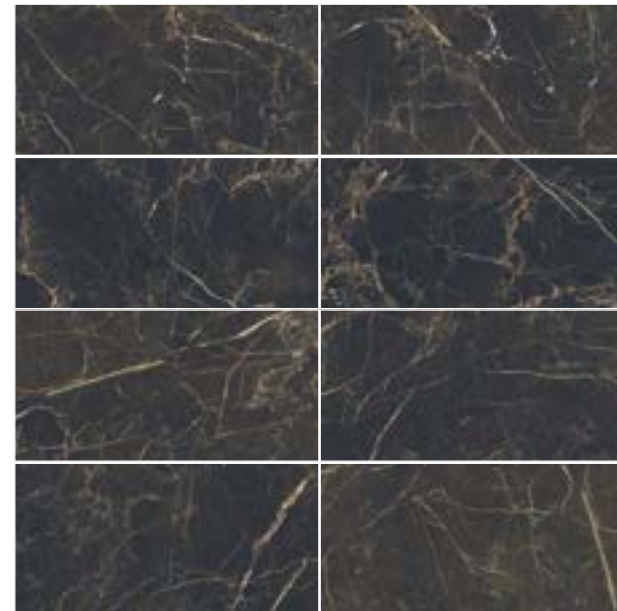

60X120 - 8 PIEZAS/8 PIECES/8 PIÈCES
60X60 - 16 PIEZAS/16 PIECES/16 PIÈCES

COMPOSICIÓN MIRROR · MIRROR COMPOSITION



6 **RU4** MIRROR NIGHT LUX A POL. RECT
60 X 120 / 24" X 48" **L32/M**

6 **RU4** MIRROR NIGHT LUX B POL. RECT
60 X 120 / 24" X 48" **L32/M**

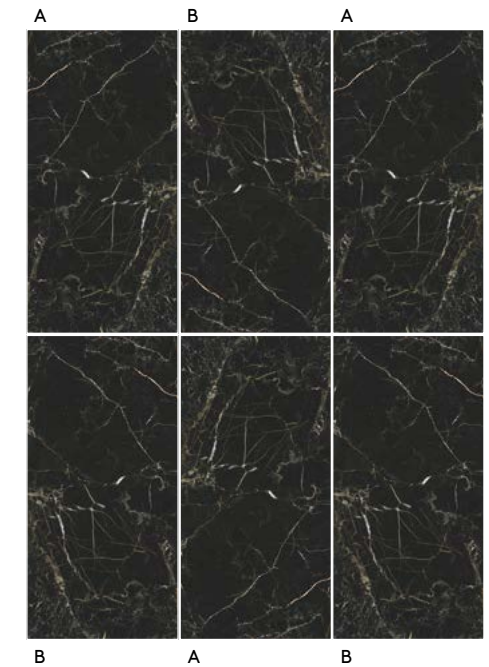

NIGHT LUX MATT RECT 60X120 ZAKU MIELE MATT RECT 80X80 KOEN MIELE MATT RECT 20X120



MIRROR NIGHT LUX A POL. RECT 60X120, NIGHT LUX POL. RECT 60X120, NUANCES NATURAL RECT 20X120.

CARACTERÍSTICAS TÉCNICAS · TECHNICAL CHARACTERISTICS

- P** PORCELÁNICO/PORCELAIN TILES
GRÉS CERÁME/FEINSTEINZEUG
- MASA COLOREADA/COLORED BODY**
TEINTÉE DANS LA MASSE/DURCHFÄRBT
- ANTIHIELO/FROST PROOF**
RÉSISTANT AU GEL/FROSTSCHUTZ
- RECTIFICADO/RECTIFIED**
RECTIFIÉ/KALIBRIERT
- V2** VARIACION LEVE/SLIGHT VARIATION
LÉGERÉ VARIATION/LEICHT FARBSPIEL

FORMATO SIZE FORMAT VERPACKUNG	PZS/CAJA TILES/BOX PIÈCES/BOITE	M²/CAJA SQM/BOX MÈTRES/BOITE	KG/CAJA KG/BOX KG/BOITE	CAJAS/PALLET BOXES/PALLET BOITES/PALETTE	M²/PALLET SQM/PALLET MÈTRES/PALETTE	KG/PALLET KG/PALLET MÈTRES/PALETTE
60X120	2	1.43	32.37	30	42.98	971
60X60	4	1.44	33.22	32	46.08	1063

RODAPIÉS · SKIRTING BOARDS



M ROD. NIGHT LUX MATT
75 X 60 / 3" X 24" K24/P

6 ROD. NIGHT LUX POL
75 X 60 / 3" X 24" K29/P

Para más información técnica, especificaciones e imágenes visite nuestra web y busque: Night lux

El embalaje de los artículos está sujeto a variaciones, para obtener el dato exacto y actual se recomienda consultar la web.

For more technical information, specifications and images, visit our website and search: Night lux

The packing of our items is subject to variations. To get the most accurate and updated information, we recommend to check the website.

Pour plus d'informations techniques, de spécifications et de visuels, visitez notre site web et recherchez : Night lux

L'emballage des articles est sujet à variation, pour obtenir les données exactes et actuelles il est recommandé de consulter notre site web.

VARIACIÓN DE DISEÑO - GRAPHIC FACES



ONICE NACAR POL RECT
60 X 120 / 24" X 48" J89/M



ONICE HONEY POL RECT
60 X 120 / 24" X 48" J89/M



ONICE SKY POL RECT
60 X 120 / 24" X 48" J89/M

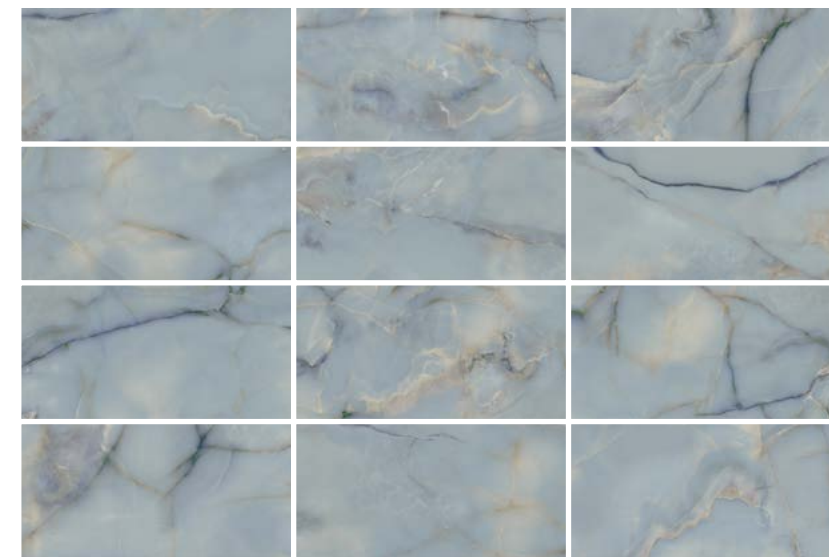

60X120 - 12 PIEZAS/12 PIECES/12 PIÈCES



ONICE NACAR POL RECT 60X120. MIRROR ONICE NACARA POL RECT 60X120.
MIRROR ONICE NACAR B POL RECT 60X120.



MIRROR ONICE NACAR B POL RECT
60 X 120 / 24" X 48" L32/M



MIRROR ONICE NACAR A POL RECT
60 X 120 / 24" X 48" L32/M



MIRROR ONICE HONEY B POL RECT
60 X 120 / 24" X 48" L32/M



MIRROR ONICE HONEY A POL RECT
60 X 120 / 24" X 48" L32/M



MIRROR ONICE SKY B POL RECT
60 X 120 / 24" X 48" L32/M



MIRROR ONICE SKY A POL RECT
60 X 120 / 24" X 48" L32/M

COMPOSICIÓN MIRROR - MIRROR COMPOSITION



CARACTERÍSTICAS TÉCNICAS - TECHNICAL CHARACTERISTICS

- P** PORCELÁNICO/PORCELAIN TILES
GRÈS CERÁME/FEINSTEINZEUG
- V2** VARIACION LEVE/SLIGHT VARIATION
LÉGERÉ VARIATION/LEICHT FARBSPIEL
- G** GRANILLA PULIDA/GRAIN POLISHED
GRAIN POLI/TECHNISCHES POLIERTES FEINSTEINZEUG
- ANTHIELO/FROST PROOF**
RÉSISTANT AU GEL/FROSTSCHUTZ
- RECTIFICADO/RECTIFIED**
RECTIFIÉ/KALIBRIERT
- RU4** USO RECOMENDADO/RECOMMENED USE - RU4

FORMATO SIZE FORMAT VERPACKUNG	PZS/CAJA TILES/BOX PIÈCES/BOITE	M²/CAJA SQM/BOX MÈTRES/BOITE	KG/CAJA KG/BOX KG/BOITE	CAJAS/PALLET BOXES/PALLET BOITES/PALETTE	M²/PALLET SQM/PALLET MÈTRES/PALETTE	KG/PALLET KG/PALLET MÈTRES/PALETTE
60X120	2	1.43	31.80	30	42.98	954

Para más información técnica, especificaciones e imágenes visite nuestra web y busque: Onice
El embalaje de los artículos está sujeto a variaciones, para obtener el dato exacto y actual se recomienda consultar la web.
For more technical information, specifications and images, visit our website and search: Onice
The packing of our items is subject to variations. To get the most accurate and updated information, we recommend to check the website.
Pour plus d'informations techniques, de spécifications et de visuels, visitez notre site web et recherchez: Onice
L'emballage des articles est sujet à variation, pour obtenir les données exactes et actuelles il est recommandé de consulter notre site web.

Onyx slow



M **RUS** ONYX SLOW MATT RECT
120 X 120 / 48" X 48" **N31/M**

E **RU4** ONYX SLOW POL. RECT
120 X 120 / 48" X 48" **PO6/M**



M **RUS** ONYX SLOW MATT RECT
60 X 120 / 24" X 48" **R60/M**

E **RU4** ONYX SLOW POL RECT
60 X 120 / 24" X 48" **J18/M**



M **RUS** ONYX SLOW MATT RECT.
60 X 60 / 24" X 24" **PO7/M**

E **RU4** ONYX SLOW POL RECT
60 X 60 / 24" X 24" **N29/M**



E **RU4** DECOR SET(2) ONYX SLOW POL.
60 X 120 / 24" X 48" **K68/P**

VARIACIÓN DE DISEÑO · GRAPHIC FACES



120X120 - 6 PIEZAS/6 PIECES/6 PIÈCES
60X120 - 12 PIEZAS/12 PIECES/12 PIÈCES
60X60 - 24 PIEZAS/24 PIECES/24 PIÈCES
40X120 - 24 PIEZAS/24 PIECES/24 PIÈCES
7.5X30 - 40 PIEZAS/40 PIECES/40 PIÈCES

CARACTERÍSTICAS TÉCNICAS · TECHNICAL CHARACTERISTICS

- P** PORCELÁNICO/PORCELAIN TILES
GRÉS CERÁME/FEINSTEINZEUG
- V2** VARIACION LEVE/SLIGHT VARIATION
LÉGERE VARIATION/LEICHT FARBSPIEL
- E** RECTIFICADO/RECTIFIED
RECTIFIÉ/KALIBRIERT
- S** ANTIHIELO/FROST PROOF
RÉSISTANT AU GEL/FROSTSCHUTZ

FORMATO SIZE FORMAT VERPACKUNG	PZS/CAJA TILES/BOX PIÈCES/BOITE	M²/CAJA SQM/BOX MÈTRES/BOITE	KG/CAJA KG/BOX KG/BOITE	CAJAS/PALLET BOXES/PALLET BOITES/PALETTE	M²/PALLET SQM/PALLET MÈTRES/PALETTE	KG/PALLET KG/PALLET MÈTRES/PALETTE
120X120	1	1.44	36.61	36	51.84	1318
60X120	2	1.44	35.22	30	43.20	1057
60X60	4	1.44	31.70	30	43.20	951

Para más información técnica, especificaciones e imágenes visite nuestra web y busque: Onyx slow
El embalaje de los artículos está sujeto a variaciones, para obtener el dato exacto y actual se recomienda consultar la web.

For more technical information, specifications and images, visit our website and search: Onyx slow
The packing of our items is subject to variations. To get the most accurate and updated information, we recommend to check the website.

Pour plus d'informations techniques, de spécifications et de visuels, visitez notre site web et recherchez : Onyx slow
L'emballage des articles est sujet à variation, pour obtenir les données exactes et actuelles il est recommandé de consulter notre site web.

Onyx slow 40x120



M ONYX SLOW MATT RECT.
40 X 120 / 16" X 48" **L25/M**



M BOHEMIAN ONYX SLOW MATT RECT.
40 X 120 / 16" X 48" **L26/M**



E DECOR SET(2) FEATHER ONYX
40 X 120 / 16" X 48" **K81/P**



RUS ONYX SLOW MATT
75 X 30 / 3" X 12" **L20/M**



P **RUS** **S** HEXAGON ONYX SLOW
13,9 X 16 / 5,5" X 6,3" **N70/M**



P **B** **RUS** **S** HEXA BOHO ONYX SLOW
13,9 X 16 / 5,5" X 6,3" **L07/M**

PB **M** **V2**

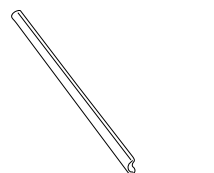

EDGE STICK ONYX SLOW
1,5 X 30 / 0,6" X 12" **K18/P**



CARACTERÍSTICAS TÉCNICAS · TECHNICAL CHARACTERISTICS

- PB** PASTA BLANCA/WHITE BODY
PÂTE BLANCHE/WEISSSCHERBIG
- M** MATE/MATT
MAT/MATT
- E** REVESTIMIENTO/WALL TILE
FAÏENCE/WANDFLIESEN
- V2** VARIACION LEVE/SLIGHT VARIATION
LÉGERE VARIATION/LEICHT FARBSPIEL

FORMATO SIZE FORMAT VERPACKUNG	PZS/CAJA TILES/BOX PIÈCES/BOITE	M²/CAJA SQM/BOX MÈTRES/BOITE	KG/CAJA KG/BOX KG/BOITE	CAJAS/PALLET BOXES/PALLET BOITES/PALETTE	M²/PALLET SQM/PALLET MÈTRES/PALETTE	KG/PALLET KG/PALLET MÈTRES/PALETTE
60X60	4	1.44	31.70	30	43.20	951
40X120	3	1.44	28.20	20	28.80	564
13,9X16	20	0.33	6.68	105	34.65	701
7,5X30	44	1.00	14.55	60	60.00	873

Para más información técnica, especificaciones e imágenes visite nuestra web y busque: Onyx slow 40x120
El embalaje de los artículos está sujeto a variaciones, para obtener el dato exacto y actual se recomienda consultar la web.

For more technical information, specifications and images, visit our website and search: Onyx slow 40x120
The packing of our items is subject to variations. To get the most accurate and updated information, we recommend to check the website.

Pour plus d'informations techniques, de spécifications et de visuels, visitez notre site web et recherchez : Onyx slow 40x120
L'emballage des articles est sujet à variation, pour obtenir les données exactes et actuelles il est recommandé de consulter notre site web.

Gaya quartzite



GAYA QUARTZITE POL RECT
60 X 120 / 24" X 48" P34/M

VARIACIÓN DE DISEÑO · GRAPHIC FACES

60X120 - 11 PIEZAS/11 PIECES/11 PIÈCES



GAYA QUARTZITE POL RECT. 60X120

CARACTERÍSTICAS TÉCNICAS · TECHNICAL CHARACTERISTICS

- P** PORCELÁNICO/PORCELAIN TILES
GRÈS CERÁME/FEINSTEINZEUG
- V2** VARIACION LEVE/SLIGHT VARIATION
LÉGERÉ VARIATION/LEICHT FARBSPIEL
- G** GRANILLA PULIDA/GRAIN POLISHED
GRAIN POLI/TECHNISCHES POLIERTES FEINSTEINZEUG
- ❄️** ANTIHIELO/FROST PROOF
RÉSISTANT AU GEL/FROSTSCHUTZ
- 📏** RECTIFICADO/RECTIFIED
RECTIFIÉ/KALIBRIERT
- RU4** USO RECOMENDADO/RECOMMENED USE - RU4

FORMATO SIZE FORMAT VERPACKUNG	PZS/CAJA TILES/BOX PIÈCES/BOITE	M²/CAJA SQM/BOX MÈTRES/BOITE	KG/CAJA KG/BOX KG/BOITE	CAJAS/PALLET BOXES/PALLET BOITES/PALETTE	M²/PALLET SQM/PALLET MÈTRES/PALETTE	KG/PALLET KG/PALLET MÈTRES/PALETTE
60X120	2	1.44	34.84	32	46.08	1115

Para más información técnica, especificaciones e imágenes visite nuestra web y busque: Gaya quartzite
El embalaje de los artículos está sujeto a variaciones, para obtener el dato exacto y actual se recomienda consultar la web.

For more technical information, specifications and images, visit our website and search: Gaya quartzite
The packing of our items is subject to variations. To get the most accurate and updated information, we recommend to check the website.

Pour plus d'informations techniques, de spécifications et de visuels, visitez notre site web et recherchez : Gaya quartzite
L'emballage des articles est sujet à variation, pour obtenir les données exactes et actuelles il est recommandé de consulter notre site web.



Oxyd jewel

VARIACIÓN DE DISEÑO · GRAPHIC FACES



OXYD JEWEL POL RECT
60 X 120 / 24" X 48" J89/M



60X120 - 12 PIEZAS/12 PIECES/12 PIÈCES

COMPOSICIÓN MIRROR · MIRROR COMPOSITION



MIRROR OXYD JEWEL A POL RECT
60 X 120 / 24" X 48" L32/M



MIRROR OXYD JEWEL B POL RECT
60 X 120 / 24" X 48" L32/M



CARACTERÍSTICAS TÉCNICAS · TECHNICAL CHARACTERISTICS

- P** PORCELÁNICO/PORCELAIN TILES
GRÈS CERÁME/FEINSTEINZEUG
- V2** VARIACION LEVE/SLIGHT VARIATION
LÉGERÉ VARIATION/LEICHT FARBSPIEL
- G** GRANILLA PULIDA/GRAIN POLISHED
GRAIN POLI/TECHNISCHES POLIERTES FEINSTEINZEUG
- ❄️** ANTIHIELO/FROST PROOF
RÉSISTANT AU GEL/FROSTSCHUTZ
- 📏** RECTIFICADO/RECTIFIED
RECTIFIÉ/KALIBRIERT
- RU4** USO RECOMENDADO/RECOMMENED USE - RU4

FORMATO SIZE FORMAT VERPACKUNG	PZS/CAJA TILES/BOX PIÈCES/BOITE	M²/CAJA SQM/BOX MÈTRES/BOITE	KG/CAJA KG/BOX KG/BOITE	CAJAS/PALLET BOXES/PALLET BOITES/PALETTE	M²/PALLET SQM/PALLET MÈTRES/PALETTE	KG/PALLET KG/PALLET MÈTRES/PALETTE
60X120	2	1.43	31.93	30	42.98	958

Para más información técnica, especificaciones e imágenes visite nuestra web y busque: Oxyd jewel
El embalaje de los artículos está sujeto a variaciones, para obtener el dato exacto y actual se recomienda consultar la web.

For more technical information, specifications and images, visit our website and search: Oxyd jewel
The packing of our items is subject to variations. To get the most accurate and updated information, we recommend to check the website.

Pour plus d'informations techniques, de spécifications et de visuels, visitez notre site web et recherchez : Oxyd jewel
L'emballage des articles est sujet à variation, pour obtenir les données exactes et actuelles il est recommandé de consulter notre site web.



PERSIAN ONIX POLISHED RECT
60 X 120 / 24" X 48" P34/M

RODAPIÉS · SKIRTING BOARDS

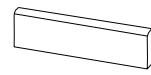

ROD. PERSIAN ONIX POL
75 X 60 / 3" X 24" K29/P

VARIACIÓN DE DISEÑO · GRAPHIC FACES

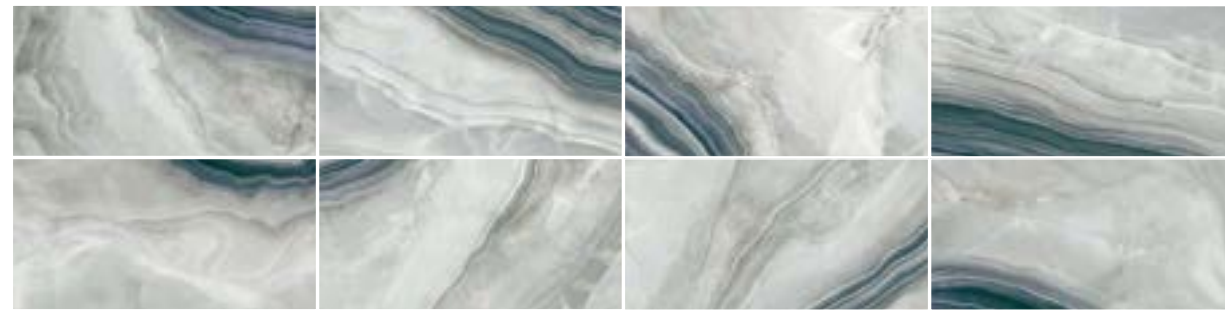

60X120 - 8 PIEZAS/8 PIECES/8 PIÈCES



PERSIAN ONIX POLISHED RECT 60X120.

CARACTERÍSTICAS TÉCNICAS · TECHNICAL CHARACTERISTICS

- P** PORCELÁNICO/PORCELAIN TILES
GRÈS CERÁME/FEINSTEINZEUG
- G** GRANILLA PULIDA/GRAIN POLISHED
GRAIN POLI/TECHNISCHES POLIERTES FEINSTEINZEUG
- R** RECTIFICADO/RECTIFIED
RECTIFIÉ/KALIBRIERT
- V2** VARIACION LEVE/SLIGHT VARIATION
LÉGERÉ VARIATION/LEICHT FARBSPIEL
- S** ANTIHIELO/FROST PROOF
RÉSISTANT AU GEL/FROSTSCHUTZ
- RU4** USO RECOMENDADO/RECOMMENED USE - RU4

FORMATO SIZE FORMAT VERPACKUNG	PZS/CAJA TILES/BOX PIÈCES/BOITE	M²/CAJA SQM/BOX MÈTRES/BOITE	KG/CAJA KG/BOX KG/BOITE	CAJAS/PALLET BOXES/PALLET BOITES/PALETTE	M²/PALLET SQM/PALLET MÈTRES/PALETTE	KG/PALLET KG/PALLET MÈTRES/PALETTE
60X120	2	1.44	35.53	32	46.08	1137

Para más información técnica, especificaciones e imágenes visite nuestra web y busque: Persian onix
El embalaje de los artículos está sujeto a variaciones, para obtener el dato exacto y actual se recomienda consultar la web.
For more technical information, specifications and images, visit our website and search: Persian onix
The packing of our items is subject to variations. To get the most accurate and updated information, we recommend to check the website.
Pour plus d'informations techniques, de spécifications et de visuels, visitez notre site web et recherchez : Persian onix
L'emballage des articles est sujet à variation, pour obtenir les données exactes et actuelles il est recommandé de consulter notre site web.



ELEGANZA CREAM MATT RECT.
75 X 75 / 30" X 30" P93/M



ELEGANZA CREAM MATT RECT
60 X 120 / 24" X 48" R60/M

ELEGANZA CREAM POLISHED RECT.
75 X 75 / 30" X 30" J15/M

ELEGANZA CREAM POLISHED RECT
60 X 120 / 24" X 48" J18/M

RODAPIÉS · SKIRTING BOARDS

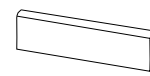

ROD. ELEGANZA MATT
75 X 60 / 3" X 24" K24/P

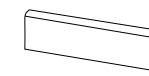

ROD. ELEGANZA MATT
75 X 75 / 3" X 30" K18/P

ROD. ELEGANZA POL.
75 X 60 / 3" X 24" K29/P

ROD. ELEGANZA POL.
75 X 75 / 3" X 30" K21/P

VARIACIÓN DE DISEÑO · GRAPHIC FACES

60X120 - 6 PIEZAS/6 PIECES/6 PIÈCES
75X75 - 12 PIEZAS/12 PIECES/12 PIÈCES



ELEGANZA CREAM POL. RECT. 75X75.

CARACTERÍSTICAS TÉCNICAS · TECHNICAL CHARACTERISTICS

- P** PORCELÁNICO/PORCELAIN TILES
GRÈS CERÁME/FEINSTEINZEUG
- R** RECTIFICADO/RECTIFIED
RECTIFIÉ/KALIBRIERT
- V2** VARIACION LEVE/SLIGHT VARIATION
LÉGERÉ VARIATION/LEICHT FARBSPIEL
- S** ANTIHIELO/FROST PROOF
RÉSISTANT AU GEL/FROSTSCHUTZ

FORMATO SIZE FORMAT VERPACKUNG	PZS/CAJA TILES/BOX PIÈCES/BOITE	M²/CAJA SQM/BOX MÈTRES/BOITE	KG/CAJA KG/BOX KG/BOITE	CAJAS/PALLET BOXES/PALLET BOITES/PALETTE	M²/PALLET SQM/PALLET MÈTRES/PALETTE	KG/PALLET KG/PALLET MÈTRES/PALETTE
75X75	2	1.11	24.60	42	46.62	1033
60X120	2	1.44	34.34	32	46.08	1099

Para más información técnica, especificaciones e imágenes visite nuestra web y busque: Eleganza
El embalaje de los artículos está sujeto a variaciones, para obtener el dato exacto y actual se recomienda consultar la web.
For more technical information, specifications and images, visit our website and search: Eleganza
The packing of our items is subject to variations. To get the most accurate and updated information, we recommend to check the website.
Pour plus d'informations techniques, de spécifications et de visuels, visitez notre site web et recherchez : Eleganza
L'emballage des articles est sujet à variation, pour obtenir les données exactes et actuelles il est recommandé de consulter notre site web.



MOONLIGHT WHITE POLISHED RECT.
75 X 75 / 30" X 30" J15/M

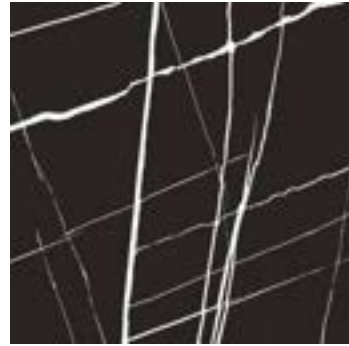

MOONLIGHT BLACK POLISHED RECT.
75 X 75 / 30" X 30" R77/M

VARIACIÓN DE DISEÑO · GRAPHIC FACES

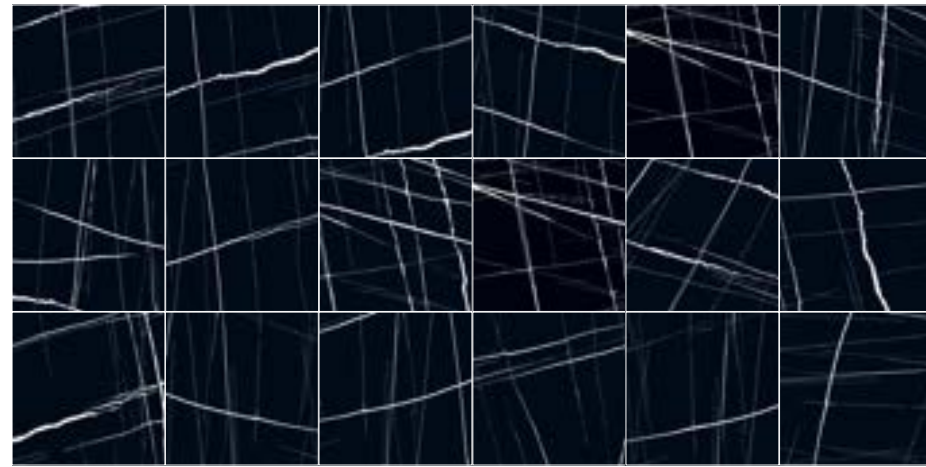

75X75 - 18 PIEZAS/18 PIECES/18 PIÈCES

RODAPÍÉS · SKIRTING BOARDS



DISPONIBLE EN TODOS LOS COLORES / AVAILABLE IN ALL COLORS



ROD. MOONLIGHT POL.
75 X 75 / 3" X 30" K21/P

CARACTERÍSTICAS TÉCNICAS · TECHNICAL CHARACTERISTICS

- P** PORCELÁNICO/PORCELAIN TILES
GRÉS CERÁME/FEINSTEINZEUG
- E** ESMALTE PULIDO/GLAZE POLISHED SHINY
ÉMAIL POLI BRILLANT/HOCHGLANZ POLIERT
- RECT** RECTIFICADO/RECTIFIED
RECTIFIÉ/KALIBRIERT
- V2** VARIACION LEVE/SLIGHT VARIATION
LÉGERÉ VARIATION/LEICHT FARBSPIEL
- SNOW** ANTIHIELO/FROST PROOF
RÉSISTANT AU GEL/FROSTSCHUTZ
- RU4** USO RECOMENDADO/RECOMMENED USE - RU4

FORMATO SIZE FORMAT VERPACKUNG	PZS/CAJA TILES/BOX PIÈCES/BOITE	M²/CAJA SQM/BOX MÈTRES/BOITE	KG/CAJA KG/BOX KG/BOITE	CAJAS/PALLET BOXES/PALLET BOITES/PALETTE	M²/PALLET SQM/PALLET MÈTRES/PALETTE	KG/PALLET KG/PALLET MÈTRES/PALETTE
75X75	2	1.11	24.98	42	46.62	1049

Para más información técnica, especificaciones e imágenes visite nuestra web y busque: Moonlight
El embalaje de los artículos está sujeto a variaciones, para obtener el dato exacto y actual se recomienda consultar la web.

For more technical information, specifications and images, visit our website and search: Moonlight
The packing of our items is subject to variations. To get the most accurate and updated information, we recommend to check the website.

Pour plus d'informations techniques, de spécifications et de visuels, visitez notre site web et recherchez : Moonlight
L'emballage des articles est sujet à variation, pour obtenir les données exactes et actuelles il est recommandé de consulter notre site web.

MOONLIGHT WHITE POLISHED RECT. 75X75. MOONLIGHT BLACK POLISHED RECT. 75X75.



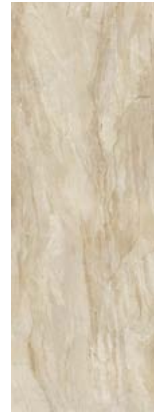

GIO NATURAL RECT.
31.6 X 90 / 12.5" X 36" **R11/M**

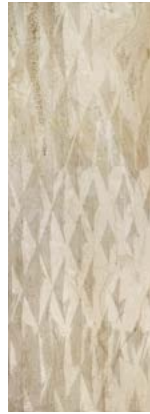

OXANA NATURAL RECT.
31.6 X 90 / 12.5" X 36" **N53/M**

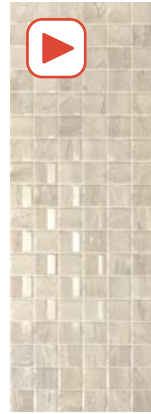

GABO NATURAL RECT.
31.6 X 90 / 12.5" X 36" **N53/M**



BOISERIE GIO NATURAL RECT.
31.6 X 90 / 12.5" X 36" **N53/M**



ZOCALO GIO NATURAL
15 X 31.6 / 6" X 12.5" **K16/P**



CENEFA GIO NATURAL
8 X 31.6 / 3" X 12.5" **K08/P**



MOLDURA GIO NATURAL
3 X 31.6 / 1.2" X 12.5" **K17/P**



P M R15 GIO NATURAL MATT RECT.
75 X 75 / 30" X 30" **P93/M**



P R14 GIO NATURAL POLISHED RECT.
75 X 75 / 30" X 30" **J15/M**



P M R15 GIO NATURAL MATT RECT.
60 X 120 / 24" X 48" **J53/M**



P R14 GIO NATURAL POL. RECT.
60 X 120 / 24" X 48" **J89/M**



RODAPIÉS · SKIRTING BOARDS **P V3**



M ROD. GIO NATURAL MATT
75 X 75 / 3" X 30" **K18/P**

R15 ROD. GIO NATURAL POL.
75 X 75 / 3" X 30" **K21/P**

CARACTERÍSTICAS TÉCNICAS · TECHNICAL CHARACTERISTICS

PB PASTA BLANCA/WHITE BODY
PÂTE BLANCHE/WEISSSCHERBIG

R15 RECTIFICADO/RECTIFIED
RECTIFIÉ/KALIBRIERT

R14 REVESTIMIENTO/WALL TILE
FAÏENCE/WANDFLIESEN

V3 VARIACION MODERADA/MODERATE VARIATION
MODÉRÉE VARIATION/MITTLERES FARBSPIEL

R15 BRILLO/SHINE
BRILLANT/GLÄNZEN

FORMATO SIZE FORMAT VERPACKUNG	PZS/CAJA TILES/BOX PIÈCES/BOITE	M ² /CAJA SQM/BOX MÈTRES/BOITE	KG/CAJA KG/BOX KG/BOITE	CAJAS/PALLET BOXES/PALLET BOITES/PALETTE	M ² /PALLET SQM/PALLET MÈTRES/PALETTE	KG/PALLET KG/PALLET MÈTRES/PALETTE
75X75	2	1.11	24.64	42	46.62	1035
60X120	2	1.43	24.33	30	42.98	730
31,6X90	4	1.14	21.31	48	54.60	1023

Para más información técnica, especificaciones e imágenes visite nuestra web y busque: Gio
El embalaje de los artículos está sujeto a variaciones, para obtener el dato exacto y actual se recomienda consultar la web.

For more technical information, specifications and images, visit our website and search: Gio
The packing of our items is subject to variations. To get the most accurate and updated information, we recommend to check the website.

Pour plus d'informations techniques, de spécifications et de visuels, visitez notre site web et recherchez : Gio
L'emballage des articles est sujet à variation, pour obtenir les données exactes et actuelles il est recommandé de consulter notre site web.



GIO NATURAL POL. RECT. 60X120.

Jordan

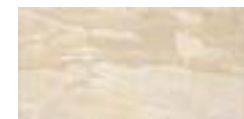

JORDAN BEIGE
25 X 50 / 10" X 20" R01/M



JORDAN NATURAL
25 X 50 / 10" X 20" R01/M



DECOR MITO/JORDAN NATURAL
25 X 50 / 10" X 20" K12/P



DECOR KAREM
25 X 50 / 10" X 20" K13/P



CENEFA JORDAN BEIGE
12 X 50 / 5" X 20" K61/P



CENEFA JORDAN NATURAL
12 X 50 / 5" X 20" K61/P



TACO VIVENDI/JORDAN
22 X 22 / 9" X 9" K12/P



CENEFA VIVENDI/JORDAN
22 X 45 / 9" X 18" K12/P

PAVIMENTO RECOMENDADO · RECOMMENDED FLOORING

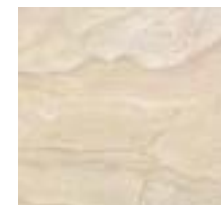

JORDAN BEIGE
45 X 45 / 18" X 18" N11/M



JORDAN NATURAL
45 X 45 / 18" X 18" N11/M



JORDAN BEIGE 25X50, JORDAN NATURAL 45X45, CENEFA VIVENDI/JORDAN 22X45, TACO VIVENDI/JORDAN 22X22

CARACTERÍSTICAS TÉCNICAS · TECHNICAL CHARACTERISTICS

- PR** PASTA ROJA/RED BODY
PÂTE ROUGE/ROTSCHERBIG
- B** BRILLO/SHINE
BRILLANT/GLÄNZEN
- V3** REVESTIMIENTO/WALL TILE
FAÏENCE/WANDFLIESEN
- V3** VARIACION MODERADA/MODERATE VARIATION
MODÉRÉE VARIATION/MITTLERES FARBSPIEL

FORMATO SIZE FORMAT VERPACKUNG	PZS/CAJA TILES/BOX PIÈCES/BOITE	M²/CAJA SQM/BOX MÈTRES/BOITE	KG/CAJA KG/BOX KG/BOITE	CAJAS/PALLET BOXES/PALLET BOITES/PALETTE	M²/PALLET SQM/PALLET MÈTRES/PALETTE	KG/PALLET KG/PALLET MÈTRES/PALETTE
25X50	14	1.75	22.99	48	84.00	1103

Para más información técnica, especificaciones e imágenes visite nuestra web y busque: Jordan
El embalaje de los artículos está sujeto a variaciones, para obtener el dato exacto y actual se recomienda consultar la web.

For more technical information, specifications and images, visit our website and search: Jordan
The packing of our items is subject to variations. To get the most accurate and updated information, we recommend to check the website.

Pour plus d'informations techniques, de spécifications et de visuels, visitez notre site web et recherchez: Jordan
L'emballage des articles est sujet à variation, pour obtenir les données exactes et actuelles il est recommandé de consulter notre site web.



Rex 25x75



REX PEARL SHINE
25 X 75 / 10" X 30" P57/M



FIGURE PEARL SHINE
25 X 75 / 10" X 30" P58/M



BOISERIE REX PEARL SHINE
25 X 75 / 10" X 30" P58/M



DECOR SET(2) REX PEARL
25 X 75 / 10" X 30" K71/P



CENEFA REX PEARL
10 X 25 / 4" X 10" K33/P



CENEFA COLISEUM SILVER
8 X 75 / 3" X 30" K58/P



CENEFA COLISEUM SILVER
8 X 25 / 3" X 10" K46/P



REX CREAM SHINE
25 X 75 / 10" X 30" P57/M



FIGURE CREAM SHINE
25 X 75 / 10" X 30" P58/M



BOISERIE REX CREAM SHINE
25 X 75 / 10" X 30" P58/M



DECOR SET(2) REX CREAM
25 X 75 / 10" X 30" K53/P



CENEFA REX CREAM
10 X 25 / 4" X 10" K33/P



CENEFA COLISEUM GOLD
8 X 75 / 3" X 30" K58/P



CENEFA COLISEUM GOLD
8 X 25 / 3" X 10" K46/P



REX

BOISERIE

FIGURE



REX PEARL
60 X 60 / 24" X 24" J27/M



REX CREAM
60 X 60 / 24" X 24" J27/M



ROSETON NOOR PEARL
60 X 60 / 24" X 24" K77/P



ROSETON NOOR CREAM
60 X 60 / 24" X 24" K77/P

CARACTERÍSTICAS TÉCNICAS · TECHNICAL CHARACTERISTICS

- PB** PASTA BLANCA/WHITE BODY
PÂTE BLANCHE/WEISSCHERBIG
- B** BRILLO/SHINE
BRILLANT/GLÄNZEN
- V2** REVESTIMIENTO/WALL TILE
FAÏENCE/WANDFLIESEN
- V2** VARIACION LEVE/SLIGHT VARIATION
LÉGERÉ VARIATION/LEICHT FARBSPIEL

FORMATO SIZE FORMAT VERPACKUNG	PZS/CAJA TILES/BOX PIÈCES/BOITE	M²/CAJA SQM/BOX MÈTRES/BOITE	KG/CAJA KG/BOX KG/BOITE	CAJAS/PALLET BOXES/PALLET BOITES/PALETTE	M²/PALLET SQM/PALLET MÈTRES/PALETTE	KG/PALLET KG/PALLET MÈTRES/PALETTE
60X60	4	1.44	30.94	22	31.68	681
25X75	7	1.31	20.21	48	62.88	970

Para más información técnica, especificaciones e imágenes visite nuestra web y busque: Rex 25x75
El embalaje de los artículos está sujeto a variaciones, para obtener el dato exacto y actual se recomienda consultar la web.

For more technical information, specifications and images, visit our website and search: Rex 25x75
The packing of our items is subject to variations. To get the most accurate and updated information, we recommend to check the website.

Pour plus d'informations techniques, de spécifications et de visuels, visitez notre site web et recherchez: Rex 25x75
L'emballage des articles est sujet à variation, pour obtenir les données exactes et actuelles il est recommandé de consulter notre site web.

Silver pearl

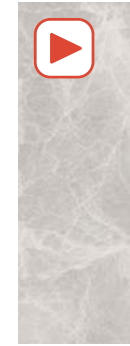

SILVER PEARL MATT
25 X 75 / 10" X 30" P57/M



TUNDRA PEARL MATT
25 X 75 / 10" X 30" P58/M



CENEFA EMILIA PEARL
9 X 25 / 3.5" X 10" K46/P



MOLDURA ROYALE PEARL
5 X 25 / 2" X 10" K26/P



CENEFA ROYALE PEARL
10 X 25 / 4" X 10" K87/P



CENEFA GHADA SILVER MATT
8 X 25 / 3" X 10" K46/P

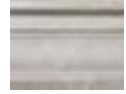

ZOCALO ROYALE PEARL
20 X 25 / 8" X 10" K33/P



WEB COLLECTION



DECOR SET(2) CALATHEA PEARL
25 X 75 / 10" X 30" K71/P



CENEFA GHADA SILVER MATT
8 X 75 / 3" X 30" K58/P

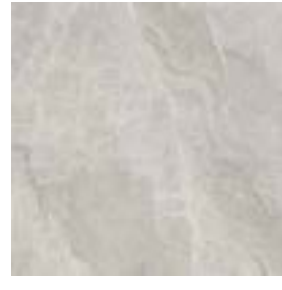

SILVER PEARL MATT
60 X 60 / 24" X 24" J27/M



CARACTERÍSTICAS TÉCNICAS · TECHNICAL CHARACTERISTICS

PB PASTA BLANCA/WHITE BODY
PÂTE BLANCHE/WEISSSCHERBIG

M MATE/MATT
MAT/MATT

V2 REVESTIMIENTO/WALL TILE
FAÏENCE/WANDFLIESEN

V2 VARIACION LEVE/SLIGHT VARIATION
LÉGERÉ VARIATION/LEICHT FARBSPIEL

FORMATO SIZE FORMAT VERPACKUNG	PZS/CAJA TILES/BOX PIÈCES/BOITE	M²/CAJA SQM/BOX MÈTRES/BOITE	KG/CAJA KG/BOX KG/BOITE	CAJAS/PALLET BOXES/PALLET BOITES/PALETTE	M²/PALLET SQM/PALLET MÈTRES/PALETTE	KG/PALLET KG/PALLET MÈTRES/PALETTE
60X60	4	1.44	27.94	32	46.08	894
25X75	7	1.31	18.69	48	62.88	897

Para más información técnica, especificaciones e imágenes visite nuestra web y busque: Silver pearl
El embalaje de los artículos está sujeto a variaciones, para obtener el dato exacto y actual se recomienda consultar la web.

For more technical information, specifications and images, visit our website and search: Silver pearl
The packing of our items is subject to variations. To get the most accurate and updated information, we recommend to check the website.

Pour plus d'informations techniques, de spécifications et de visuels, visitez notre site web et recherchez : Silver pearl
L'emballage des articles est sujet à variation, pour obtenir les données exactes et actuelles il est recommandé de consulter notre site web.

Statuary



WEB COLLECTION



STATUARY MATT
25 X 75 / 10" X 30" P57/M



POMPEYA MATT
25 X 75 / 10" X 30" P58/M



STATUARY SHINE
25 X 75 / 10" X 30" P57/M



TROYA SHINE
25 X 75 / 10" X 30" P58/M



DECOR KIRVI SILVER SHINE
25 X 75 / 10" X 30" K71/P



DECOR STATUARY SHINE
25 X 75 / 10" X 30" K52/P



CENEFA DYE MATT
9 X 25 / 3.5" X 10" K46/P



CENEFA DYE SHINE
9 X 25 / 3.5" X 10" K46/P



CENEFA RAISSA SILVER MATT
8 X 25 / 3" X 10" K46/P



CENEFA RAISSA SILVER MATT
8 X 75 / 3" X 30" K58/P



CENEFA OLAYA SILVER SHINE
8 X 25 / 3" X 10" K46/P



CENEFA OLAYA SILVER SHINE
8 X 75 / 3" X 30" K58/P



MOLDURA STATUARY MATT
5 X 25 / 2" X 10" K26/P



CENEFA STATUARY MATT
10 X 25 / 4" X 10" K87/P

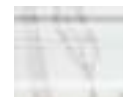

ZOCALO STATUARY MATT
20 X 25 / 8" X 10" K33/P

DECOR SET(3) ARECA MATT
25 X 75 / 10" X 30" K71/P

PAVIMENTO RECOMENDADO · RECOMMENDED FLOORING **V2**



STATUARY MATT
60 X 60 / 24" X 24" J27/M



STATUARY SHINE
60 X 60 / 24" X 24" J27/M



ROSETON SELIMA SHINE
60 X 60 / 24" X 24" K77/P

CARACTERÍSTICAS TÉCNICAS · TECHNICAL CHARACTERISTICS

PB PASTA BLANCA/WHITE BODY
PÂTE BLANCHE/WEISSSCHERBIG

V2 REVESTIMIENTO/WALL TILE
FAÏENCE/WANDFLIESEN

V2 VARIACION LEVE/SLIGHT VARIATION
LÉGERÉ VARIATION/LEICHT FARBSPIEL

FORMATO SIZE FORMAT VERPACKUNG	PZS/CAJA TILES/BOX PIÈCES/BOITE	M²/CAJA SQM/BOX MÈTRES/BOITE	KG/CAJA KG/BOX KG/BOITE	CAJAS/PALLET BOXES/PALLET BOITES/PALETTE	M²/PALLET SQM/PALLET MÈTRES/PALETTE	KG/PALLET KG/PALLET MÈTRES/PALETTE
25X75	7	1.31	20.56	48	62.88	987

Para más información técnica, especificaciones e imágenes visite nuestra web y busque: Statuary
El embalaje de los artículos está sujeto a variaciones, para obtener el dato exacto y actual se recomienda consultar la web.

For more technical information, specifications and images, visit our website and search: Statuary
The packing of our items is subject to variations. To get the most accurate and updated information, we recommend to check the website.

Pour plus d'informations techniques, de spécifications et de visuels, visitez notre site web et recherchez : Statuary
L'emballage des articles est sujet à variation, pour obtenir les données exactes et actuelles il est recommandé de consulter notre site web.



***B** TRAVERTINO SILVER SHINE 25 X 75 / 10" X 30" P57/M

***B** SIENA SILVER SHINE 25 X 75 / 10" X 30" P58/M

***B** BOISERIE TRAVERTINO SILVER SHINE 25 X 75 / 10" X 30" P58/M

***B** DECOR ANISA SHINE SILVER 25 X 75 / 10" X 30" K71/P

***B** CENEFA SABBA SILVER SHINE 8 X 75 / 3" X 30" K58/P

***B** DECOR SET(2) SIENA SILVER SHINE 25 X 75 / 10" X 30" K71/P

***B** CENEFA DALILA SILVER SHINE 8 X 25 / 3" X 10" K46/P

***B** CENEFA SIENA SILVER SHINE 10 X 25 / 4" X 10" K33/P



M TRAVERTINO SILVER MATT 25 X 75 / 10" X 30" P57/M

M LEA SILVER MATT 25 X 75 / 10" X 30" P58/M

M ZOCALO TRAVERTINO SILVER MATT 20 X 25 / 8" X 10" K33/P

M DECOR SET(2) TRAVERTINO SILVER MATT 25 X 75 / 10" X 30" K71/P

M CENEFA DALILA SILVER MATT 8 X 75 / 3" X 30" K58/P

M CENEFA SABBA SILVER MATT 8 X 25 / 3" X 10" K46/P



***B** TRAVERTINO BRESCIA SHINE 25 X 75 / 10" X 30" P57/M

***B** SIENA BRESCIA SHINE 25 X 75 / 10" X 30" P58/M

***B** BOISERIE TRAVERTINO BRESCIA SHINE 25 X 75 / 10" X 30" P58/M

***B** DECOR ANISA SHINE BRESCIA 25 X 75 / 10" X 30" K71/P

***B** CENEFA SABBA GOLD SHINE 8 X 75 / 3" X 30" K58/P

***B** DECOR SET(2) SIENA BRESCIA SHINE 25 X 75 / 10" X 30" K53/P

***B** CENEFA DALILA GOLD SHINE 8 X 25 / 3" X 10" K46/P

***B** CENEFA SIENA BRESCIA SHINE 10 X 25 / 4" X 10" K33/P

M TRAVERTINO BRESCIA MATT 25 X 75 / 10" X 30" P57/M

M LEA BRESCIA MATT 25 X 75 / 10" X 30" P58/M

M ZOCALO TRAVERTINO BRESCIA MATT 20 X 25 / 8" X 10" K33/P

M DECOR SET(2) TRAVERTINO BRESCIA MATT 25 X 75 / 10" X 30" K53/P

M CENEFA DALILA GOLD MATT 8 X 75 / 3" X 30" K58/P

M CENEFA SABBA GOLD MATT 8 X 25 / 3" X 10" K46/P

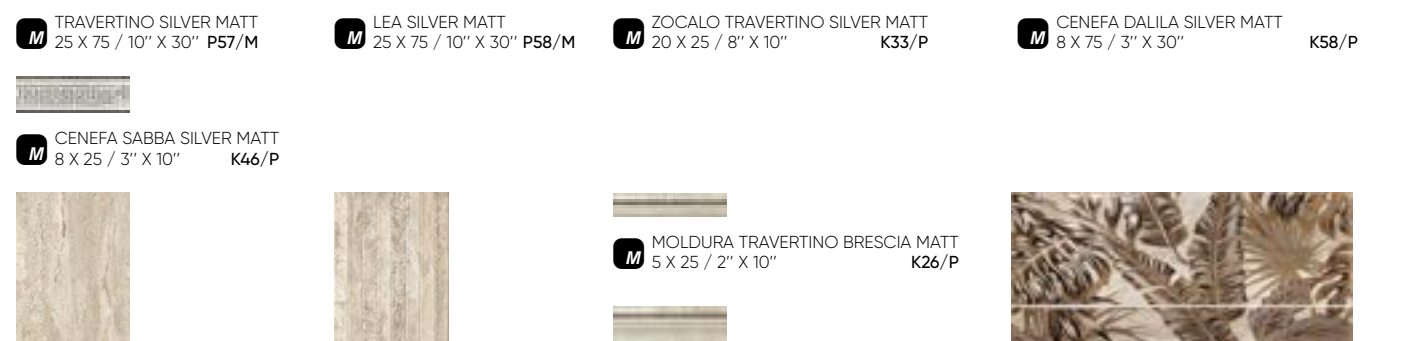

***B** TRAVERTINO BRESCIA SHINE 25 X 75 / 10" X 30" P57/M

***B** SIENA BRESCIA SHINE 25 X 75 / 10" X 30" P58/M

***B** BOISERIE TRAVERTINO BRESCIA SHINE 25 X 75 / 10" X 30" P58/M

***B** DECOR ANISA SHINE BRESCIA 25 X 75 / 10" X 30" K71/P

***B** CENEFA SABBA GOLD SHINE 8 X 75 / 3" X 30" K58/P

***B** DECOR SET(2) SIENA BRESCIA SHINE 25 X 75 / 10" X 30" K53/P

***B** CENEFA DALILA GOLD SHINE 8 X 25 / 3" X 10" K46/P

***B** CENEFA SIENA BRESCIA SHINE 10 X 25 / 4" X 10" K33/P



M TRAVERTINO BRESCIA MATT 25 X 75 / 10" X 30" P57/M

M LEA BRESCIA MATT 25 X 75 / 10" X 30" P58/M

M ZOCALO TRAVERTINO BRESCIA MATT 20 X 25 / 8" X 10" K33/P

M DECOR SET(2) TRAVERTINO BRESCIA MATT 25 X 75 / 10" X 30" K53/P

M CENEFA DALILA GOLD MATT 8 X 75 / 3" X 30" K58/P

M CENEFA SABBA GOLD MATT 8 X 25 / 3" X 10" K46/P

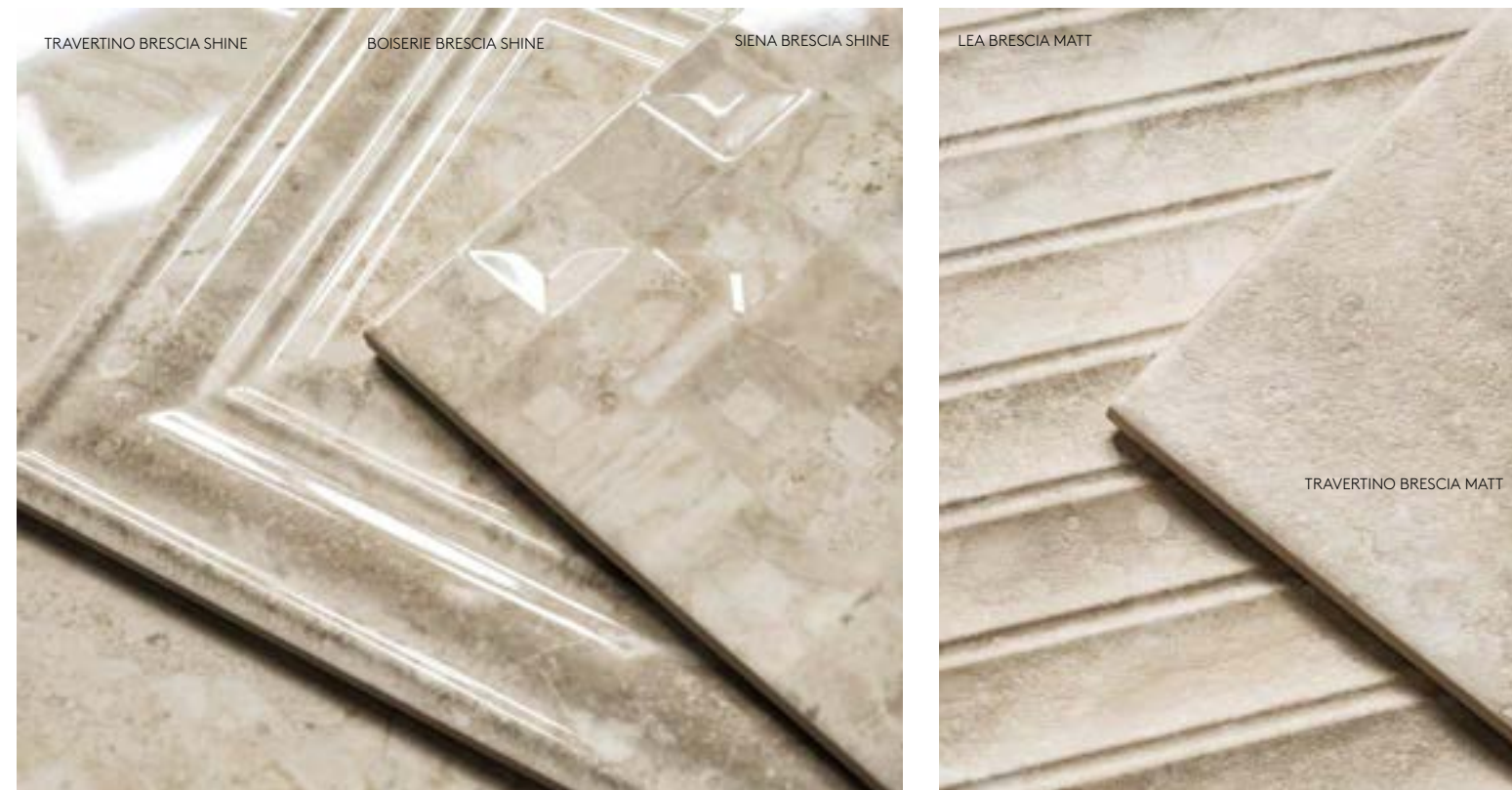

CARACTERÍSTICAS TÉCNICAS · TECHNICAL CHARACTERISTICS

PB PASTA BLANCA / WHITE BODY
PÂTE BLANCHE / WEISSCHERBIG

V2 VARIACION LEVE / SLIGHT VARIATION
LÉGERÉ VARIATION / LEICHT FARBSPIEL

RE REVESTIMIENTO / WALL TILE
FAÏENCE / WANDFLIESEN

FORMATO SIZE FORMAT VERPACKUNG	PZS/CAJA TILES/BOX PIÈCES/BOITE	M ² /CAJA SQM/BOX MÈTRES/BOITE	KG/CAJA KG/BOX KG/BOITE	CAJAS/PALLET BOXES/PALLET BOITES/PALETTE	M ² /PALLET SQM/PALLET MÈTRES/PALETTE	KG/PALLET KG/PALLET MÈTRES/PALETTE
10X25	14	0.35	7.92	84	29.40	665
20X25	10	0.50	6.15	92	46.00	566
25X75	7	1.31	20.73	48	62.88	995
5X25	28	0.35	5.17	70	24.50	362
8X25	20	0.40	6.45	84	33.60	542
8X75	15	0.90	14.96	100	90.00	1496

Para más información técnica, especificaciones e imágenes visite nuestra web y busque: Travertino
El embalaje de los artículos está sujeto a variaciones, para obtener el dato exacto y actual se recomienda consultar la web.

For more technical information, specifications and images, visit our website and search: Travertino
The packing of our items is subject to variations. To get the most accurate and updated information, we recommend to check the website.

Pour plus d'informations techniques, de spécifications et de visuels, visitez notre site web et recherchez: Travertino
L'emballage des articles est sujet à variation, pour obtenir les données exactes et actuelles il est recommandé de consulter notre site web.

Stone



Our ceramic stone offer takes you on a journey around the world, collecting some of the most interesting, unique and elegant stones on the planet. These proposals offer a wide spectrum that adjusts to any space.

Nuestra oferta de piedra cerámica es un viaje por todo el mundo, recogiendo algunas de las piedras más elegantes, interesantes y únicas del planeta. Propuestas que ofrecen un amplio espectro para ajustarse a cualquier espacio.





M V2 RELIEVO BOURG RECT
60 X 120 / 24" X 48" P23/M



M V2 RELIEVO BOURG RECT
30 X 120 / 12" X 48" P24/M



M V2 RELIEVO BOURG RECT
20 X 120 / 8" X 48" P24/M



M C2 R10 V2 BOURG RECT
60 X 120 / 24" X 48" P20/M

*** V2** BOURG LAP RECT
60 X 120 / 24" X 48" P19/M

M C3 R11 V2 ANTI-SLIP BOURG RECT
60 X 120 / 24" X 48" P25/M



M C3 R11 V2 BOURG RECT
40 X 120 (2CM) / 16" X 48" P28/M * *"Espesor 20mm / thickness 0.8"*



BOURG RECT 60X120 RELIEVO BOURG RECT 60X120 HARLEQUIN SKY 10X20.



ANTI-SLIP BOURG RECT 60X120.

4.Stones



M **R10** **V2** CEPPPO RECT
60 X 120 / 24" X 48" P42/M

***V2** CEPPPO LAP RECT
60 X 120 / 24" X 48" L71/M

M **C3** **R11** **V2** ANTI-SLIP CEPPPO RECT
60 X 120 / 24" X 48" L72/M



M **R10** **V2** CEPPPO RECT
30 X 120 / 12" X 48" P22/M

***V2** CEPPPO LAP RECT
30 X 120 / 12" X 48" P21/M



M **R10** **V2** CEPPPO RECT
20 X 120 / 8" X 48" P22/M

***V2** CEPPPO LAP RECT
20 X 120 / 8" X 48" P21/M



M **V2** RELIEVO CEPPPO RECT
60 X 120 / 24" X 48" P23/M



M **V2** RELIEVO CEPPPO RECT
30 X 120 / 12" X 48" P24/M



M **V2** RELIEVO CEPPPO RECT
20 X 120 / 8" X 48" P24/M



M **C2** **R10** **V2** CEPPPO RECT.
90 X 90 / 36" X 36" P10/M



4.Stones



M C2 R10 V2 PANAMA RECT
60 X 120 / 24" X 48" P20/M

*** V2** PANAMA LAP RECT
60 X 120 / 24" X 48" P19/M

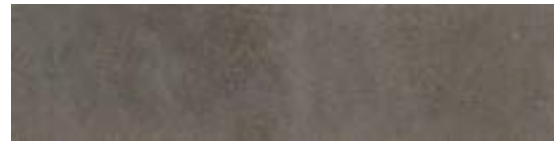

M C2 R10 V2 PANAMA RECT
30 X 120 / 12" X 48" P22/M

*** V2** PANAMA LAP RECT
30 X 120 / 12" X 48" P21/M

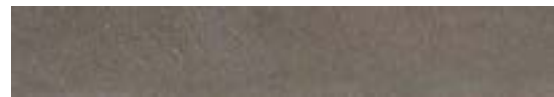

M C2 R10 V2 PANAMA RECT
20 X 120 / 8" X 48" P22/M

*** V2** PANAMA LAP RECT
20 X 120 / 8" X 48" P21/M



M V2 RELIEVO PANAMA RECT
60 X 120 / 24" X 48" P23/M



M V2 RELIEVO PANAMA RECT
30 X 120 / 12" X 48" P24/M



M V2 RELIEVO PANAMA RECT
20 X 120 / 8" X 48" P24/M



PANAMA RECT 60X120.RELIEVO PANAMA RECT 60X120.ON VICTORIAN GREEN GLOSS 4,3X24,3



PANAMA RECT 30X120.PANAMA RECT 60X120.RELIEVO PANAMA RECT 20X120.RELIEVO PANAMA RECT 60X120.



M C3 R10 V3 VALMALENCO RECT
60 X 120 / 24" X 48" **P20/M**

V3 VALMALENCO LAP RECT
60 X 120 / 24" X 48" **P19/M**

M C3 R11 V3 ANTI-SLIP VALMALENCO RECT
60 X 120 / 24" X 48" **P25/M**

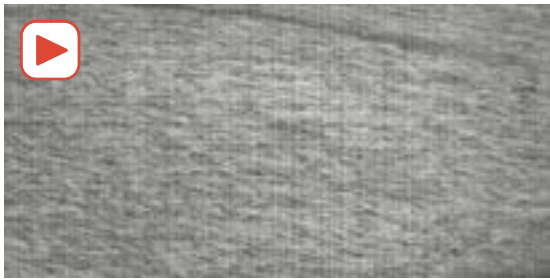

M V3 RELIEVO VALMALENCO RECT
60 X 120 / 24" X 48" **P23/M**



M C3 R10 V3 VALMALENCO RECT
30 X 120 / 12" X 48" **P22/M**

V3 VALMALENCO LAP RECT
30 X 120 / 12" X 48" **P21/M**



M V3 RELIEVO VALMALENCO RECT
30 X 120 / 12" X 48" **P24/M**



M C3 R10 V3 VALMALENCO RECT
20 X 120 / 8" X 48" **P22/M**

V3 VALMALENCO LAP RECT
20 X 120 / 8" X 48" **P21/M**



M V3 RELIEVO VALMALENCO RECT
20 X 120 / 8" X 48" **P24/M**

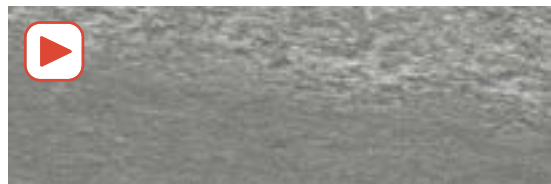

M C3 R11 V3 VALMALENCO RECT
40 X 120 (2CM) / 16" X 48" **P28/M**

*Espesor 20mm / thickness 0.8"

ESPESORADO / THICKNESS



CARACTERÍSTICAS TÉCNICAS · TECHNICAL CHARACTERISTICS

- P** PORCELÁNICO/PORCELAIN TILES
GRÈS CERÁMICO/FEINSTEINZEUG
- M** MASA COLOREADA/COLORED BODY
TEINTÉE DANS LA MASSE/DURCHGEFÄRBT
- R11** RECTIFICADO/RECTIFIED
RECTIFIÉ/KALIBRIERT
- R10** ANTIHIELO/FROST PROOF
RÉSISTANT AU GEL/FROSTSCHUTZ
- RUS** USO RECOMENDADO/RECOMMENED USE - RUS

FORMATO SIZE FORMAT VERPACKUNG	PZS/CAJA TILES/BOX PIÈCES/BOITE	M²/CAJA SQM/BOX MÈTRES/BOITE	KG/CAJA KG/BOX KG/BOITE	CAJAS/PALLET BOXES/PALLET BOITES/PALETTE	M²/PALLET SQM/PALLET MÈTRES/PALETTE	KG/PALLET KG/PALLET MÈTRES/PALETTE
90X90	2	1.62	36.88	24	38.88	885
60X120	2	1.44	33.50	36	51.84	1206
40X120	1	0.48	22.38	48	23.04	1074
30X120	4	1.44	33.89	36	51.84	1220
20X120	4	0.96	22.65	40	38.40	906

Para más información técnica, especificaciones e imágenes visite nuestra web y busque: 4.Stones
El embalaje de los artículos está sujeto a variaciones, para obtener el dato exacto y actual se recomienda consultar la web.
For more technical information, specifications and images, visit our website and search: 4.Stones
The packing of our items is subject to variations. To get the most accurate and updated information, we recommend to check the website.
Pour plus d'informations techniques, de spécifications et de visuels, visitez notre site web et recherchez : 4.Stones
L'emballage des articles est sujet à variation, pour obtenir les données exactes et actuelles il est recommandé de consulter notre site web.



ANTI-SLIP VALMALENCO RECT 60X120 VALMALENCO RECT 40X120 (2CM)

RODAPIÉS · SKIRTING BOARDS **P**

DISPONIBLE EN TODOS LOS COLORES / AVAILABLE IN ALL COLORS

- M V2** ZANQUIN RECTO BOURG
75 X 60 / 3" X 24" **K09/P**
- M V3** ZANQUIN RECTO VALMALENCO
75 X 60 / 3" X 24" **K09/P**

- M V3** ROD. VALMALENCO
75 X 60 / 3" X 24" **K24/P**
- M V2** ROD. BOURG
75 X 60 / 3" X 24" **K24/P**
- M V2** ROD. CEPPO
75 X 60 / 3" X 24" **K24/P**
- M V2** ROD. PANAMA
75 X 60 / 3" X 24" **K24/P**
- V3** ROD. VALMALENCO LAP.
75 X 60 / 3" X 24" **K24/P**
- V2** ROD. BOURG LAP.
75 X 60 / 3" X 24" **K24/P**
- V2** ROD. CEPPO LAP.
75 X 60 / 3" X 24" **K24/P**
- V2** ROD. PANAMA LAP.
75 X 60 / 3" X 24" **K24/P**
- M V3** ROD. VALMALENCO
75 X 90 / 3" X 36" **K14/P**
- M V2** ROD. CEPPO
75 X 90 / 3" X 36" **K14/P**
- M V2** TABICA BOURG
15 X 120 / 6" X 48" **K11/P**
- M V3** TABICA VALMALENCO
15 X 120 / 6" X 48" **K11/P**

PELDAÑOS · STEPS **M**

- C3 R11 V2** PELDAÑO RECTO ANT. C3 BOURG
33 X 120 / 13" X 48" **K91/P**
- V2** PELDAÑO RECTO C1 BOURG
33 X 120 / 13" X 48" **K91/P**
- C3 R11 V3** PELDAÑO RECTO ANT. C3 VALMALENCO
33 X 120 / 13" X 48" **K91/P**
- V3** PELDAÑO RECTO C1 VALMALENCO
33 X 120 / 13" X 48" **K91/P**

PIEZAS PISCINA · POOLS **M**

- C3 R11 V2** BORDE PISCINA BOURG
28 X 66.5 / 11" X 26" **K94/P**
- C3 R11 V3** BORDE PISCINA VALMALENCO
28 X 66.5 / 11" X 26" **K94/P**
- V2** REF. 222 MEDIA CAÑA BOURG
4 X 33 / 1.5" X 13" **K29/P**
- V2** REF. 232 UÑA BOURG
4 X 4 / 1.5" X 1.5" **K06/P**



CROSS WHITE RECT
60 X 120 / 24" X 48"



CROSS SAND RECT
60 X 120 / 24" X 48"



CROSS TAUPE RECT
60 X 120 / 24" X 48"

ANTI-SLIP CROSS WHITE RECT
60 X 120 / 24" X 48" N74/M

ANTI-SLIP CROSS SAND RECT
60 X 120 / 24" X 48" N74/M

ANTI-SLIP CROSS TAUPE RECT
60 X 120 / 24" X 48" N74/M



CROSS WHITE RECT.
60 X 60 / 24" X 24" P07/M



CROSS SAND RECT.
60 X 60 / 24" X 24" P07/M



CROSS TAUPE RECT.
60 X 60 / 24" X 24" P07/M



CROSS WHITE RECT.
30 X 60 / 12" X 24" P07/M

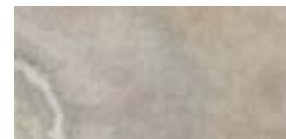

CROSS SAND RECT.
30 X 60 / 12" X 24" P07/M



CROSS TAUPE RECT.
30 X 60 / 12" X 24" P07/M



CROSS WHITE
15 X 15 / 6" X 6" L29/M



CROSS SAND
15 X 15 / 6" X 6" L29/M



CROSS TAUPE
15 X 15 / 6" X 6" L29/M

MOSAICOS · MOSAICS



MOSAICO CROSS WHITE
30 X 30 (5 X 5) / 12" X 12" K01/P

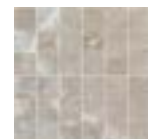

MOSAICO CROSS SAND
30 X 30 (5 X 5) / 12" X 12" K01/P



MOSAICO CROSS TAUPE
30 X 30 (5 X 5) / 12" X 12" K01/P



MALLA SPACCO CROSS WHITE
30 X 30 / 12" X 12" K70/P



MALLA SPACCO CROSS SAND
30 X 30 / 12" X 12" K70/P



MALLA SPACCO CROSS TAUPE
30 X 30 / 12" X 12" K70/P



DECOR SET(2) CROSS
60 X 120 / 24" X 48" K95/P

PELDAÑOS · STEPS

DISPONIBLE EN TODOS LOS COLORES / AVAILABLE IN ALL COLORS

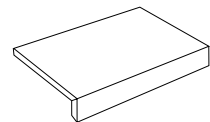

PELDAÑO RECTO CROSS C3
33 X 33 / 13" X 13" K86/P

RODAPÍES · SKIRTING BOARDS



ROD. CROSS
75 X 60 / 3" X 24" K24/P

VARIACIÓN DE DISEÑO · GRAPHIC FACES



60X120 - 12 PIEZAS/12 PIÈCES/12 PIÈCES
60X60 - 24 PIEZAS/24 PIÈCES/24 PIÈCES
30X60 - 48 PIEZAS/48 PIÈCES/48 PIÈCES
15X15 - 52 PIEZAS/52 PIÈCES/52 PIÈCES



CROSS SAND RECT 60X120, MURUS NIX 7X28, ARGILLAE FUMO RECT. 120X120.

CARACTERÍSTICAS TÉCNICAS · TECHNICAL CHARACTERISTICS

P PORCELÁNICO/PORCELAIN TILES
GRÈS CERÀME/FEINSTEINZEUG

V3 VARIACION MODERADA / MODERATE VARIATION
MODÉRÉE VARIATION / MITTLERES FARBSPIEL

M MATE / MATT
MAT / MATT

FORMATO SIZE FORMAT VERPACKUNG	PZS/CAJA TILES/BOX PIÈCES/BOITE	M²/CAJA SQM/BOX MÈTRES/BOITE	KG/CAJA KG/BOX KG/BOITE	CAJAS/PALLET BOXES/PALLET BOITES/PALETTE	M²/PALLET SQM/PALLET MÈTRES/PALETTE	KG/PALLET KG/PALLET MÈTRES/PALETTE
60X120	2	1.44	35.04	30	43.20	1051
60X60	4	1.44	28.77	30	43.20	863
30X60	6	1.08	21.52	48	51.84	1033
15X15	44	1.00	17.17	64	64.00	1099

Para más información técnica, especificaciones e imágenes visite nuestra web y busque: Cross
El embalaje de los artículos está sujeto a variaciones, para obtener el dato exacto y actual se recomienda consultar la web.
For more technical information, specifications and images, visit our website and search: Cross
The packing of our items is subject to variations. To get the most accurate and updated information, we recommend to check the website.
Pour plus d'informations techniques, de spécifications et de visuels, visitez notre site web et recherchez: Cross
L'emballage des articles est sujet à variation, pour obtenir les données exactes et actuelles il est recommandé de consulter notre site web.



TERRAZZO WHITE POL. RECT.
90 X 90 / 36" X 36"

P47/M



PB **U** **M** **C2** **R10** **RU5** HEXAGON TERRAZZO WHITE MATT
23 X 26 / 9" X 10" **N14/M**



TERRAZZO GREY POL. RECT.
90 X 90 / 36" X 36"

P47/M



PB **U** **M** **C2** **R10** **RU5** HEXAGON TERRAZZO GREY MATT
23 X 26 / 9" X 10" **N14/M**



TERRAZZO GRAPHITE POL. RECT.
90 X 90 / 36" X 36"

P47/M



PB **U** **M** **C2** **R10** **RU5** HEXAGON TERRAZZO GRAPHITE MATT
23 X 26 / 9" X 10" **N14/M**

RODAPIÉS · SKIRTING BOARDS



DISPONIBLE EN TODOS LOS COLORES / AVAILABLE IN ALL COLORS

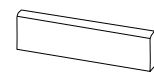

ROD. TERRAZZO POL.
75 X 90 / 3" X 36" **K14/P**

CARACTERÍSTICAS TÉCNICAS · TECHNICAL CHARACTERISTICS

- P** PORCELÁNICO/PORCELAIN TILES
GRÉS CERÁME/FEINSTEINZEUG
- U** RECTIFICADO/RECTIFIED
RECTIFIÉ/KALIBRIERT
- M** ANTIHIELO/FROST PROOF
RÉSISTANT AU GEL/FROSTSCHUTZ
- C2** ESMALTE PULIDO/GLAZE POLISHED SHINY
ÉMAIL POLI BRILLANT/HOCHGLANZ POLIERT
- R10** ASPECTO UNIFORME/UNIFORM APPEARANCE
APPARENCE UNIFORME/KEINE FARBSPIEL
- RU5** USO RECOMENDADO/RECOMMENED USE - RU4

FORMATO SIZE FORMAT VERPACKUNG	PZS/CAJA TILES/BOX PIÈCES/BOITE	M²/CAJA SQM/BOX MÈTRES/BOITE	KG/CAJA KG/BOX KG/BOITE	CAJAS/PALLET BOXES/PALLET BOITES/PALETTE	M²/PALLET SQM/PALLET MÈTRES/PALETTE	KG/PALLET KG/PALLET MÈTRES/PALETTE
90X90	1	0.81	20.35	40	32.26	814
23X26	16	0.75	19.35	60	45.00	1161

Para más información técnica, especificaciones e imágenes visite nuestra web y busque: Terrazzo
El embalaje de los artículos está sujeto a variaciones, para obtener el dato exacto y actual se recomienda consultar la web.
For more technical information, specifications and images, visit our website and search: Terrazzo
The packing of our items is subject to variations. To get the most accurate and updated information, we recommend to check the website.
Pour plus d'informations techniques, de spécifications et de visuels, visitez notre site web et recherchez : Terrazzo
L'emballage des articles est sujet à variation, pour obtenir les données exactes et actuelles il est recommandé de consulter notre site web.

TERRAZZO GRAPHITE POL. RECT. 90X90.



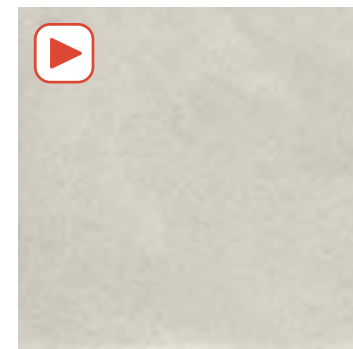

C2 R10 BURLINGTON PEARL RECT.
75 X 75 / 30" X 30" **J57/M**

C3 R11 ANTI-SLIP BURLINGTON PEARL RECT.
75 X 75 / 30" X 30" **J58/M**

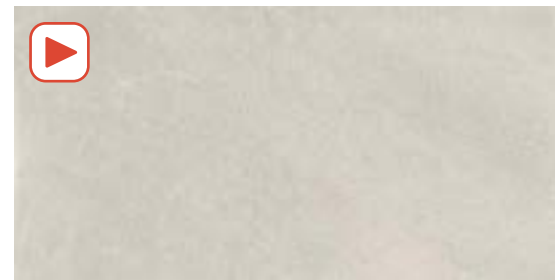

C2 R10 BURLINGTON PEARL RECT.
60 X 120 / 24" X 48" **J55/M**

C3 R11 ANTI-SLIP BURLINGTON PEARL RECT.
60 X 120 / 24" X 48" **J56/M**

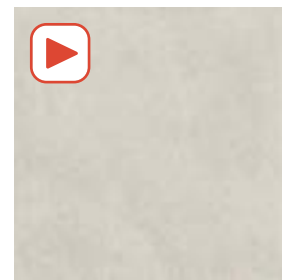

C2 R10 BURLINGTON PEARL RECT.
60 X 60 / 24" X 24" **J59/M**

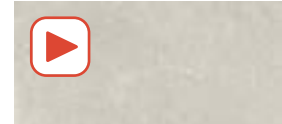

C2 R10 BURLINGTON PEARL RECT.
30 X 60 / 12" X 24" **J59/M**



C2 R10 BURLINGTON GREY RECT.
75 X 75 / 30" X 30" **J57/M**

C3 R11 ANTI-SLIP BURLINGTON GREY RECT.
75 X 75 / 30" X 30" **J58/M**

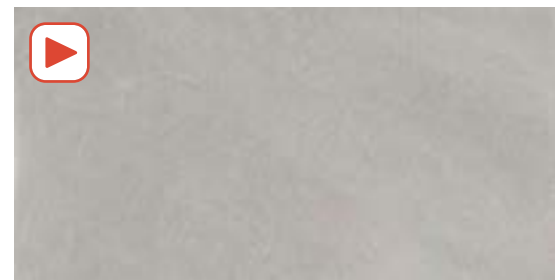

C2 R10 BURLINGTON GREY RECT.
60 X 120 / 24" X 48" **J55/M**

C3 R11 ANTI-SLIP BURLINGTON GREY RECT.
60 X 120 / 24" X 48" **J56/M**

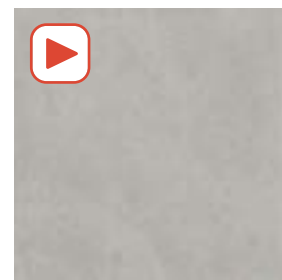

C2 R10 BURLINGTON GREY RECT.
60 X 60 / 24" X 24" **J59/M**

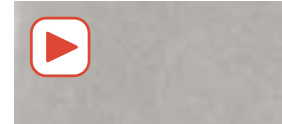

C2 R10 BURLINGTON GREY RECT.
30 X 60 / 12" X 24" **J59/M**

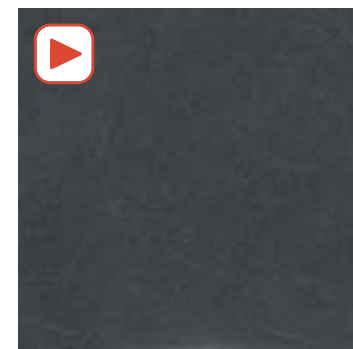

C2 R10 BURLINGTON VOLCANO RECT.
75 X 75 / 30" X 30" **J57/M**

C3 R11 ANTI-SLIP BURLINGTON VOLCANO RECT.
75 X 75 / 30" X 30" **J58/M**



C2 R10 BURLINGTON VOLCANO RECT.
60 X 120 / 24" X 48" **J55/M**

C3 R11 ANTI-SLIP BURLINGTON VOLCANO RECT.
60 X 120 / 24" X 48" **J56/M**

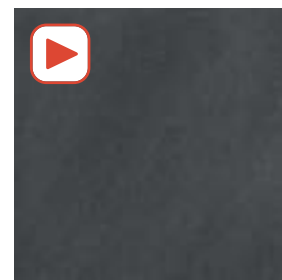

C2 R10 BURLINGTON VOLCANO RECT.
60 X 60 / 24" X 24" **J59/M**

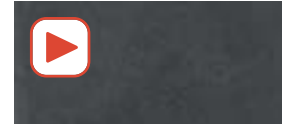

C2 R10 BURLINGTON VOLCANO RECT.
30 X 60 / 12" X 24" **J59/M**

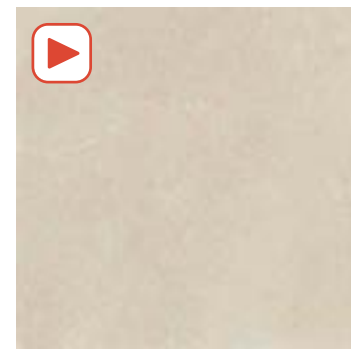

C2 R10 BURLINGTON IVORY RECT.
75 X 75 / 30" X 30" **J57/M**

C3 R11 ANTI-SLIP BURLINGTON IVORY RECT.
75 X 75 / 30" X 30" **J58/M**

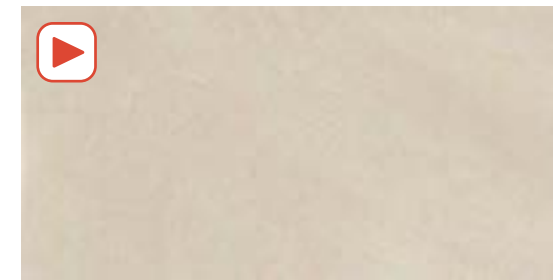

C2 R10 BURLINGTON IVORY RECT.
60 X 120 / 24" X 48" **J55/M**

C3 R11 ANTI-SLIP BURLINGTON IVORY RECT.
60 X 120 / 24" X 48" **J56/M**

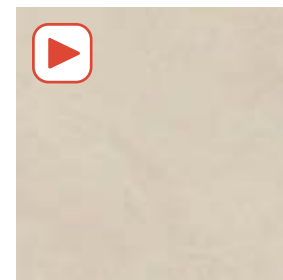

C2 R10 BURLINGTON IVORY RECT.
60 X 60 / 24" X 24" **J59/M**

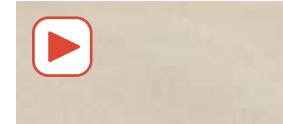

C2 R10 BURLINGTON IVORY RECT.
30 X 60 / 12" X 24" **J59/M**

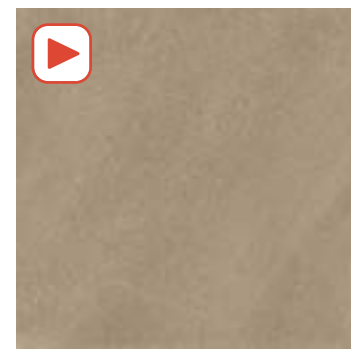

C2 R10 BURLINGTON TAUPE RECT.
75 X 75 / 30" X 30" **J57/M**

C3 R11 ANTI-SLIP BURLINGTON TAUPE RECT.
75 X 75 / 30" X 30" **J58/M**

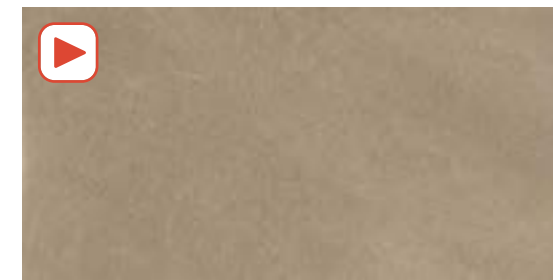

C2 R10 BURLINGTON TAUPE RECT.
60 X 120 / 24" X 48" **J55/M**

C3 R11 ANTI-SLIP BURLINGTON TAUPE RECT.
60 X 120 / 24" X 48" **J56/M**

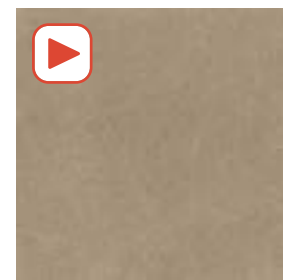

C2 R10 BURLINGTON TAUPE RECT.
60 X 60 / 24" X 24" **J59/M**

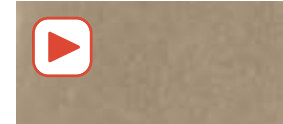

C2 R10 BURLINGTON TAUPE RECT.
30 X 60 / 12" X 24" **J59/M**

MOSAICOS · MOSAICS **P M** **V2 RU5**

DISPONIBLE EN TODOS LOS COLORES / AVAILABLE IN ALL COLORS

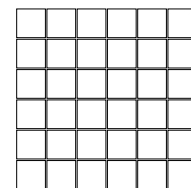

MOSAICO BURLINGTON
30 X 30 (5 X 5) / 12" X 12" **K01/P**

VARIACIÓN DE DISEÑO · GRAPHIC FACES

- 60X120 - 12 PIEZAS/12 PIECES/12 PIÈCES
- 75X75 - 12 PIEZAS/12 PIECES/12 PIÈCES
- 60X60 - 24 PIEZAS/24 PIECES/24 PIÈCES
- 30X60 - 48 PIEZAS/48 PIECES/48 PIÈCES

CARACTERÍSTICAS TÉCNICAS · TECHNICAL CHARACTERISTICS

P PORCELÁNICO/PORCELAIN TILES
GRÈS CERÁME/FEINSTEINZEUG

RE RECTIFICADO/RECTIFIED
RECTIFIÉ/KALIBRIERT

V2 VARIACION LEVE/SLIGHT VARIATION
LÉGERÉ VARIATION/LEICHT FARBSPIELTE

M MATE/MATT
MAT/MATT

MA MASA COLOREADA/COLORED BODY
TEINTÉE DANS LA MASSE/DURCHGEFÄRBT

RF ANTIHIELO/FROST PROOF
RÉSISTANT AU GEL/FROSTSCHUTZ

RU5 USO RECOMENDADO/RECOMMENED USE - RU5

FORMATO SIZE FORMAT VERPACKUNG	PZS/CAJA TILES/BOX PIÈCES/BOITE	M²/CAJA SQM/BOX MÈTRES/BOITE	KG/CAJA KG/BOX KG/BOITE	CAJAS/PALLET BOXES/PALLET BOITES/PALETTE	M²/PALLET SQM/PALLET MÈTRES/PALETTE	KG/PALLET KG/PALLET MÈTRES/PALETTE
75X75	2	1.13	24.80	48	54.00	1190
60X120	2	1.44	28.97	36	51.84	1043
60X60	3	1.08	23.63	40	43.20	945
30X60	6	1.08	25.40	40	43.20	1016

Para más información técnica, especificaciones e imágenes visite nuestra web y busque: Burlington
El embalaje de los artículos está sujeto a variaciones, para obtener el dato exacto y actual se recomienda consultar la web.

For more technical information, specifications and images, visit our website and search: Burlington
The packing of our items is subject to variations. To get the most accurate and updated information, we recommend to check the website.

Pour plus d'informations techniques, de spécifications et de visuels, visitez notre site web et recherchez: Burlington
L'emballage des articles est sujet à variation, pour obtenir les données exactes et actuelles il est recommandé de consulter notre site web.

PELDAÑOS · STEPS **P M** **C3 R11 V2 RU5**

DISPONIBLE EN TODOS LOS COLORES / AVAILABLE IN ALL COLORS

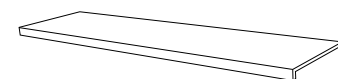

PELDAÑO RECTO ANT. C3 BURLINGTON
33 X 120 / 13" X 48" **K91/P**

RODAPIÉS · SKIRTING BOARDS **P M** **V2**

DISPONIBLE EN TODOS LOS COLORES / AVAILABLE IN ALL COLORS

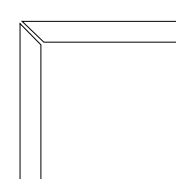

ZANQUIN RECTO BURLINGTON
75 X 60 / 3" X 24" **K09/P**

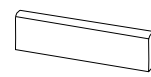

ROD. BURLINGTON
75 X 75 / 3" X 30" **K18/P**

ROD. BURLINGTON
75 X 60 / 3" X 24" **K24/P**



BURLINGTON PEARL RECT.
30 X 90 / 12" X 36" **J61/M**

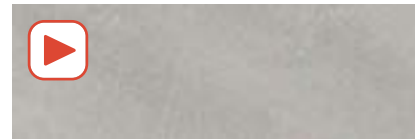

BURLINGTON GREY RECT.
30 X 90 / 12" X 36" **J61/M**

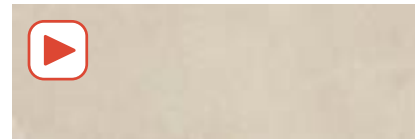

BURLINGTON IVORY RECT.
30 X 90 / 12" X 36" **J61/M**



EDEN PEARL RECT.
30 X 90 / 12" X 36" **J62/M**



EDEN GREY RECT.
30 X 90 / 12" X 36" **J62/M**



EDEN IVORY RECT.
30 X 90 / 12" X 36" **J62/M**



DECOR BURLINGTON PEARL
30 X 90 / 12" X 36" **K78/P**



DECOR BURLINGTON GREY
30 X 90 / 12" X 36" **K78/P**



DECOR BURLINGTON IVORY
30 X 90 / 12" X 36" **K78/P**



CUMBRIAN VOLCANO RECT.
30 X 90 / 12" X 36" **J62/M**



DECOR DURHAM I PEARL
30 X 90 / 12" X 36" **K39/P**



DECOR DURHAM I IVORY
30 X 90 / 12" X 36" **K39/P**

Pavimentos Recomendados / Recommended Floor Tiles :
Triana Caoba - Burlington Volcano



DECOR DURHAM II PEARL
30 X 90 / 12" X 36" **K39/P**



DECOR DURHAM II IVORY
30 X 90 / 12" X 36" **K39/P**



CUMBRIAN TAUPE RECT.
30 X 90 / 12" X 36" **J62/M**



DECOR DURHAM III PEARL
30 X 90 / 12" X 36" **K39/P**



DECOR DURHAM III IVORY
30 X 90 / 12" X 36" **K39/P**

Pavimentos Recomendados / Recommended Floor Tiles :
Triana Desierto - Burlington Taupe

VARIACIÓN DE DISEÑO · GRAPHIC FACES

30X90 - 24 PIEZAS/24 PIECES/24 PIÈCES

CARACTERÍSTICAS TÉCNICAS · TECHNICAL CHARACTERISTICS

- PB** PASTA BLANCA/WHITE BODY
PÂTE BLANCHE/WEISSSCHERBIG
- RE** REVESTIMIENTO/WALL TILE
FAÏENCE/WANDFLIESEN
- M** MATE/MATT
MAT/MATT

- R** RECTIFICADO/RECTIFIED
RECTIFIÉ/KALIBRIERT
- V2** VARIACION LEVE/SLIGHT VARIATION
LÉGERE VARIATION/LEICHT FARBSPIEL

FORMATO SIZE FORMAT VERPACKUNG	PZS/CAJA TILES/BOX PIÈCES/BOITE	M²/CAJA SQM/BOX MÈTRES/BOITE	KG/CAJA KG/BOX KG/BOITE	CAJAS/PALLET BOXES/PALLET BOITES/PALETTE	M²/PALLET SQM/PALLET MÈTRES/PALETTE	KG/PALLET KG/PALLET MÈTRES/PALETTE
30X90	4	1.08	18.51	63	68.04	1166

Para más información técnica, especificaciones e imágenes visite nuestra web y busque: Burlington
El embalaje de los artículos está sujeto a variaciones, para obtener el dato exacto y actual se recomienda consultar la web.

For more technical information, specifications and images, visit our website and search: Burlington
The packing of our items is subject to variations. To get the most accurate and updated information, we recommend to check the website.

Pour plus d'informations techniques, de spécifications et de visuels, visitez notre site web et recherchez : Burlington
L'emballage des articles est sujet à variation, pour obtenir les données exactes et actuelles il est recommandé de consulter notre site web.

BURLINGTON GREY RECT.60X120, BURLINGTON GREY RECT.60X60, DOWNTOWN PEARL 11,5X11,5, DOWNTOWN PEARL 11,5X23,2, DOWNTOWN PEARL 5,7X23,2





C3 R11 OXFORD PURE C3
33 X 66.5 / 13" X 26" L36/M

OXFORD PURE C1
33 X 66.5 / 13" X 26" R48/M



C3 R11 OXFORD ASHEN C3
33 X 66.5 / 13" X 26" L36/M

OXFORD ASHEN C1
33 X 66.5 / 13" X 26" R48/M



C3 R11 OXFORD NEUTRAL C3
33 X 66.5 / 13" X 26" L36/M

OXFORD NEUTRAL C1
33 X 66.5 / 13" X 26" R48/M



C3 R11 OXFORD SLATE C3
33 X 66.5 / 13" X 26" L36/M

OXFORD SLATE C1
33 X 66.5 / 13" X 26" R48/M



OXFORD NEUTRAL C3 33X66,5;REJILLA OXFORD NEUTRAL 24,5X24,5;BORDE DESBORDANTE OXFORD NEUTRAL 28X66,5



BORDE PISCINA OXFORD



BORDE DESBORDANTE OXFORD



PELDAÑO RECTO OXFORD



REJILLA OXFORD

PIEZAS PISCINA · POOLS



DISPONIBLE EN TODOS LOS COLORES / AVAILABLE IN ALL COLORS

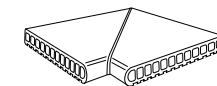

C3 R11 PAR ANGULO PISCINA INT. OXFORD
33 X 33 / 13" X 13" K39/P

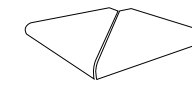

C3 R11 PAR ANGULO PISCINA EXT. OXFORD
28 X 28 / 11" X 11" K39/P



C3 R11 BORDE PISCINA OXFORD
28 X 66.5 / 11" X 26" K94/P

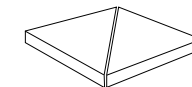

C3 R11 PAR CARTABON RECTO OXFORD
33 X 33 / 13" X 13" K78/P



REF. 222 MEDIA CAÑA OXFORD
4 X 33 / 1.5" X 13" K29/P



REF. 232 UÑA OXFORD
4 X 4 / 1.5" X 1.5" K06/P

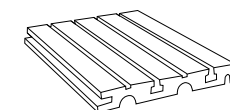

C3 R12 REJILLA OXFORD
24.5 X 24.5 / 9.4" X 9.4" K57/P

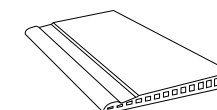

C3 R11 BORDE DESBORDANTE OXFORD
28 X 66.5 / 11" X 26" K94/P

PELDAÑOS · STEPS



DISPONIBLE EN TODOS LOS COLORES / AVAILABLE IN ALL COLORS

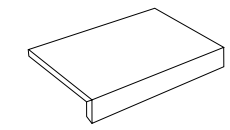

PELDAÑO RECTO OXFORD C3
33 X 33 / 13" X 13" K86/P

RODAPIÉS · SKIRTING BOARDS



DISPONIBLE EN TODOS LOS COLORES / AVAILABLE IN ALL COLORS



P ROD. OXFORD
9 X 33 / 3.5" X 13" K34/P

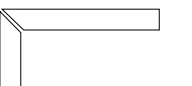

P ZANQUIN RECTO OXFORD
9 X 33 / 3.5" X 13" K09/P



P TABICA OXFORD
15 X 33 / 6" X 13" K11/P

P ZANQUIN RECTO OXFORD
9 X 33 / 3.5" X 13" K09/P

CARACTERÍSTICAS TÉCNICAS · TECHNICAL CHARACTERISTICS

- P** PORCELÁNICO/PORCELAIN TILES / GRÉS CERÁME/FEINSTEINZEUG
- V4** VARIACION FUERTE/SUBSTANTIAL VARIATION / FORTE VARIATION/HOHES FARBSPIEL
- RU5** USO RECOMENDADO/RECOMMENDED USE - RU5
- M** MATE/MATT / MAT/MATT
- SNOW** ANTIHIELO/FROST PROOF / RÉISTANT AU GEL/FROSTSCHUTZ

FORMATO SIZE FORMAT VERPACKUNG	PZS/CAJA TILES/BOX PIÈCES/BOITE	M²/CAJA SQM/BOX MÈTRES/BOITE	KG/CAJA KG/BOX KG/BOITE	CAJAS/PALLET BOXES/PALLET BOITES/PALETTE	M²/PALLET SQM/PALLET MÈTRES/PALETTE	KG/PALLET KG/PALLET MÈTRES/PALETTE
33X66,5	5	1.10	24.83	40	44.00	993

Para más información técnica, especificaciones e imágenes visite nuestra web y busque: Oxford
 El embalaje de los artículos está sujeto a variaciones, para obtener el dato exacto y actual se recomienda consultar la web.
 For more technical information, specifications and images, visit our website and search: Oxford
 The packing of our items is subject to variations. To get the most accurate and updated information, we recommend to check the website.
 Pour plus d'informations techniques, de spécifications et de visuels, visitez notre site web et recherchez: Oxford
 L'emballage des articles est sujet à variation, pour obtenir les données exactes et actuelles il est recommandé de consulter notre site web.



PIERRE DE BALI MIX
30 X 60 / 12" X 24" J27/M

C3 R11 ANTI-SLIP PIERRE DE BALI MIX
30 X 60 / 12" X 24" N79/M



C2 PIERRE DE BALI
15 X 15 / 6" X 6" R59/M

RODAPIÉS · SKIRTING BOARDS **P M V4**



ROD. PIERRE DE BALI MIX
75 X 60 / 3" X 24" K24/P

PELDAÑOS · STEPS **U M C3 R11 V4 RU5**

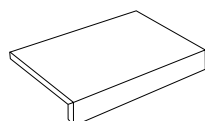

PELDAÑO RECTO PIERRE DE BALI C3 MIX
33 X 33 / 13" X 13" K86/P

VARIACIÓN DE DISEÑO · GRAPHIC FACES

30X60 - 42 PIEZAS/42 PIECES/42 PIÈCES
15X15 - 50 PIEZAS/50 PIECES/50 PIÈCES

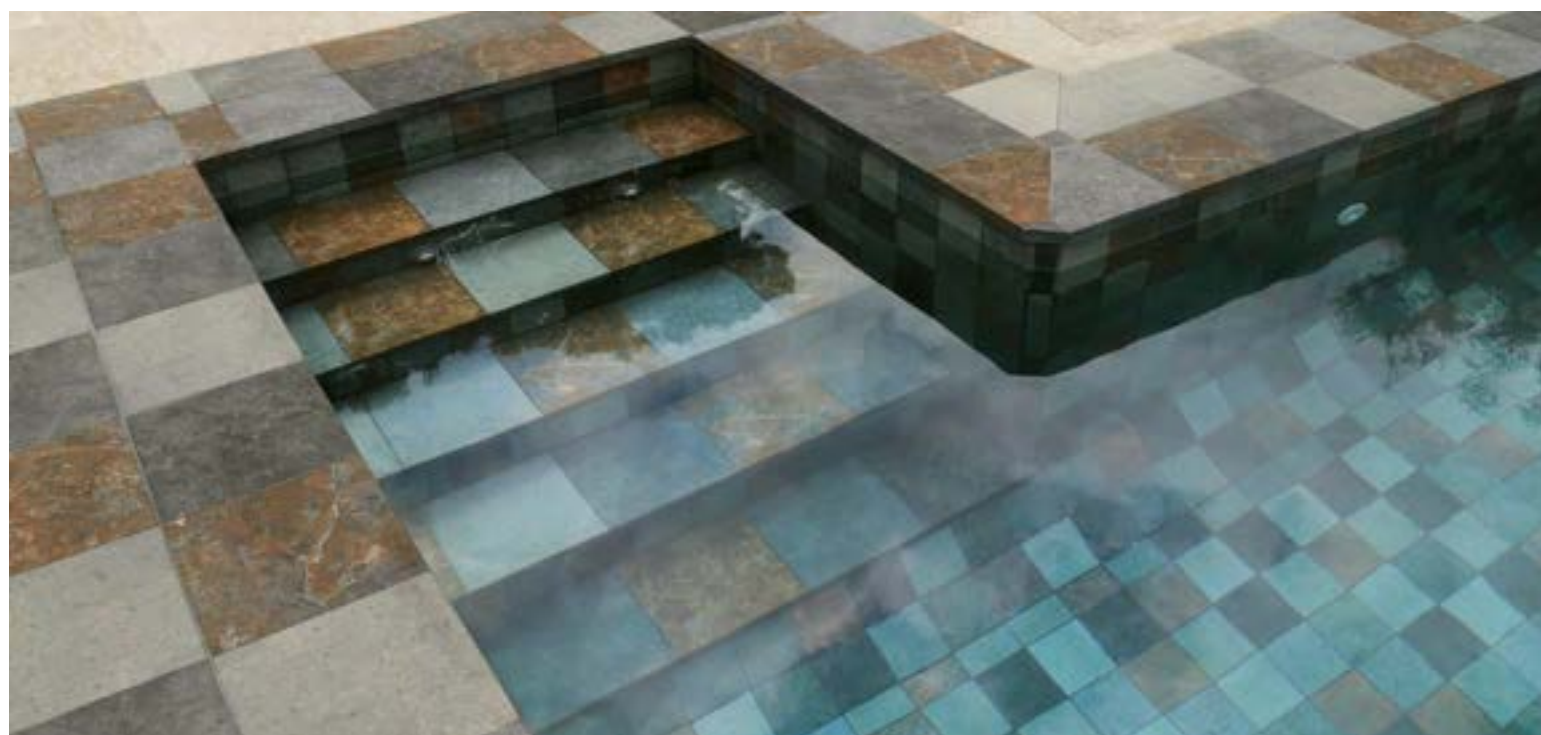

PIERRE DE BALI 15X15. PELDAÑO RECT PIERRE DE BALI C3 33X33.

CARACTERÍSTICAS TÉCNICAS · TECHNICAL CHARACTERISTICS

- P** PORCELÁNICO/PORCELAIN TILES
GRÈS CERÁME/FEINSTEINZEUG
- V4** VARIACION FUERTE/SUBSTANTIAL VARIATION
FORTE VARIATION/HOHES FARBSPIEL
- RU5** USO RECOMENDADO/RECOMMENDED USE - RU5
- M** MATE/MATT
MAT/MATT
- ❄️** ANTIHIELO/FROST PROOF
RÉSISTANT AU GEL/FROSTSCHUTZ

FORMATO SIZE FORMAT VERPACKUNG	PZS/CAJA TILES/BOX PIÈCES/BOITE	M ² /CAJA SQM/BOX MÈTRES/BOITE	KG/CAJA KG/BOX KG/BOITE	CAJAS/PALLET BOXES/PALLET BOITES/PALETTE	M ² /PALLET SQM/PALLET MÈTRES/PALETTE	KG/PALLET KG/PALLET MÈTRES/PALETTE
30X60	8	1.44	27.43	40	57.60	1097
15X15	22	0.50	9.01	120	59.40	1081

Para más información técnica, especificaciones e imágenes visite nuestra web y busque: Pierre de bali
El embalaje de los artículos está sujeto a variaciones, para obtener el dato exacto y actual se recomienda consultar la web.
For more technical information, specifications and images, visit our website and search: Pierre de bali
The packing of our items is subject to variations. To get the most accurate and updated information, we recommend to check the website.
Pour plus d'informations techniques, de spécifications et de visuels, visitez notre site web et recherchez: Pierre de bali
L'emballage des articles est sujet à variation, pour obtenir les données exactes et actuelles il est recommandé de consulter notre site web.

PIERRE DE BALI 15X15. PELDAÑO RECT PIERRE DE BALI C3 33X33.

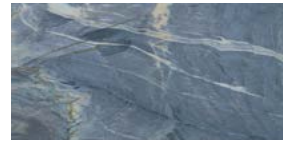

C3 R11 DEEP BLUE OXID
30 X 60 / 12" X 24" J98/M



C2 R10 DEEP BLUE OXID
15 X 15 / 6" X 6" R59/M



C2 R10 DEEP BLUE PINK
15 X 15 / 6" X 6" R59/M

VARIACIÓN DE DISEÑO · GRAPHIC FACES

30X60 - 42 PIEZAS / 42 PIECES / 42 PIÈCES
15X15 - 50 PIEZAS / 50 PIECES / 50 PIÈCES

CARACTERÍSTICAS TÉCNICAS · TECHNICAL CHARACTERISTICS

- P** PORCELÁNICO / PORCELAIN TILES
GRÉS CERÁME / FEINSTEINZEUG
- M** MATE / MATT
MAT / MATT
- V4** VARIACION FUERTE / SUBSTANTIAL VARIATION
FORTE VARIATION / HOHES FARBSPIEL
- ANTIHIELO / FROST PROOF**
RÉSISTANT AU GEL / FROSTSCHUTZ
- RU5** USO RECOMENDADO / RECOMMENED USE - RU5

FORMATO SIZE FORMAT VERPACKUNG	PZS/CAJA TILES/BOX PIÈCES/BOITE	M²/CAJA SQM/BOX MÈTRES/BOITE	KG/CAJA KG/BOX KG/BOITE	CAJAS/PALLET BOXES/PALLET BOITES/PALETTE	M²/PALLET SQM/PALLET MÈTRES/PALETTE	KG/PALLET KG/PALLET MÈTRES/PALETTE
30X60	8	1.44	24.40	60	86.40	1464
15X15	22	0.50	8.92	120	59.40	1070

Para más información técnica, especificaciones e imágenes visite nuestra web y busque: Deep blue
El embalaje de los artículos está sujeto a variaciones, para obtener el dato exacto y actual se recomienda consultar la web.
For more technical information, specifications and images, visit our website and search: Deep blue
The packing of our items is subject to variations. To get the most accurate and updated information, we recommend to check the website.
Pour plus d'informations techniques, de spécifications et de visuels, visitez notre site web et recherchez : Deep blue
L'emballage des articles est sujet à variation, pour obtenir les données exactes et actuelles il est recommandé de consulter notre site web.



DEEP BLUE PINK 15X15. PEDAÑO RECTO ANT. C3 TRAVERTINO BRESCIA 33X120. BORDE SKIMMER TRAVERTINO BRESCIA 45X75. TRAVERTINO BRESCIA STRU RECT. 60X120.



NULVI PEARL
25 X 50 / 10" X 20" J07/M



NULVI GRAPHITE
25 X 50 / 10" X 20" J07/M

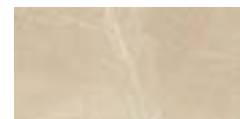

NULVI CREAM
25 X 50 / 10" X 20" J07/M



RELIEVE NULVI PEARL
25 X 50 / 10" X 20" N06/M



RELIEVE NULVI CREAM
25 X 50 / 10" X 20" N06/M

PAVIMENTO RECOMENDADO · RECOMMENDED FLOORING



TREK GRAPHITE
45 X 45 / 18" X 18" J21/M



TREK PEARL
45 X 45 / 18" X 18" J21/M



WEB
COLLECTION



WEB
COLLECTION



LUGANO PEARL
20 X 60 / 8" X 24" R17/M



LUGANO GREY
20 X 60 / 8" X 24" R17/M



LUGANO GRAPHITE
20 X 60 / 8" X 24" N80/M



HYATT GREY
20 X 60 / 8" X 24" R21/M



DECOR HAROK PEARL
20 X 60 / 8" X 24" K65/P



CENEFA HALLY PEARL
95 X 60 / 4" X 24" K48/P



CENEFA HALLY GREY
95 X 60 / 4" X 24" K48/P



CENEFA HALLY GRAPHITE
95 X 60 / 4" X 24" K48/P



RELIEVE NULVI PEARL 25X50, NULVI PEARL 25X50, NULVI GRAPHITE 25X50, TREK GRAPHITE 45X45.



LUGANO GREY 20X60, LUGANO PEARL 20X60, HYATT GREY 20X60

CARACTERÍSTICAS TÉCNICAS · TECHNICAL CHARACTERISTICS



PASTA ROJA / RED BODY
PÂTE ROUGE / ROTSCHERBIG



MATE / MATT
MAT / MATT



REVESTIMIENTO / WALL TILE
FAÏENCE / WANDFLIESEN



VARIACION MODERADA / MODERATE VARIATION
MODÉRÉE VARIATION / MITTLERES FARBSPIEL

FORMATO SIZE FORMAT VERPACKUNG	PZS/CAJA TILES/BOX PIÈCES/BOITE	M²/CAJA SQM/BOX MÈTRES/BOITE	KG/CAJA KG/BOX KG/BOITE	CAJAS/PALLET BOXES/PALLET BOITES/PALETTE	M²/PALLET SQM/PALLET MÈTRES/PALETTE	KG/PALLET KG/PALLET MÈTRES/PALETTE
25X50	12	1.50	21.02	56	84.00	1177

Para más información técnica, especificaciones e imágenes visite nuestra web y busque: Nulvi
El embalaje de los artículos está sujeto a variaciones, para obtener el dato exacto y actual se recomienda consultar la web.

For more technical information, specifications and images, visit our website and search: Nulvi
The packing of our items is subject to variations. To get the most accurate and updated information, we recommend to check the website.

Pour plus d'informations techniques, de spécifications et de visuels, visitez notre site web et recherchez : Nulvi
L'emballage des articles est sujet à variation, pour obtenir les données exactes et actuelles il est recommandé de consulter notre site web.



LIMESTONE GREY
25 X 75 / 10" X 30" **P57/M**



BAZZANI GREY
25 X 75 / 10" X 30" **P58/M**



ANDRIA GREY
25 X 75 / 10" X 30" **P58/M**



BOISERIE LIMESTONE GREY
25 X 75 / 10" X 30" **P58/M**



ZOCALO LIMESTONE GREY
20 X 25 / 8" X 10" **K33/P**



CENEFALIMESTONE GREY
10 X 25 / 4" X 10" **K28/P**

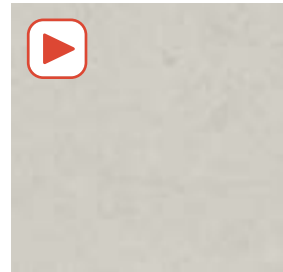

P **RUS** **N55** LIMESTONE GREY RECT.
60 X 60 / 24" X 24" **N55/M**



LIMESTONE CREAM
25 X 75 / 10" X 30" **P57/M**



BAZZANI CREAM
25 X 75 / 10" X 30" **P58/M**



ANDRIA CREAM
25 X 75 / 10" X 30" **P58/M**



BOISERIE LIMESTONE CREAM
25 X 75 / 10" X 30" **P58/M**



ZOCALO LIMESTONE CREAM
20 X 25 / 8" X 10" **K33/P**



CENEFALIMESTONE CREAM
10 X 25 / 4" X 10" **K28/P**



P **RUS** **N55** LIMESTONE CREAM RECT.
60 X 60 / 24" X 24" **N55/M**

VARIACIÓN DE DISEÑO · GRAPHIC FACES

25X75 - 24 PIEZAS/24 PIECES/24 PIÈCES

CARACTERÍSTICAS TÉCNICAS · TECHNICAL CHARACTERISTICS

PB PASTA BLANCA/WHITE BODY
PÂTE BLANCHE/WEISSSCHERBIG

M MATE/MATT
MAT/MATT

V2 REVESTIMIENTO/WALL TILE
FAÏENCE/WANDFLIESEN

V2 VARIACION LEVE/SLIGHT VARIATION
LÉGERÉ VARIATION/LEICHT FARBSPIEL

FORMATO SIZE FORMAT VERPACKUNG	PZS/CAJA TILES/BOX PIÈCES/BOITE	M²/CAJA SQM/BOX MÈTRES/BOITE	KG/CAJA KG/BOX KG/BOITE	CAJAS/PALLET BOXES/PALLET BOITES/PALETTE	M²/PALLET SQM/PALLET MÈTRES/PALETTE	KG/PALLET KG/PALLET MÈTRES/PALETTE
60X60	3	1.08	25.20	40	43.20	1008
25X75	7	1.31	20.15	48	62.88	967

Para más información técnica, especificaciones e imágenes visite nuestra web y busque: Limestone
El embalaje de los artículos está sujeto a variaciones, para obtener el dato exacto y actual se recomienda consultar la web.

For more technical information, specifications and images, visit our website and search: Limestone
The packing of our items is subject to variations. To get the most accurate and updated information, we recommend to check the website.

Pour plus d'informations techniques, de spécifications et de visuels, visitez notre site web et recherchez : Limestone
L'emballage des articles est sujet à variation, pour obtenir les données exactes et actuelles il est recommandé de consulter notre site web.

LIMESTONE GREY 25X75 / LIMESTONE GREY RECT. 60X60 / DOWNTOWN COAL 11.5X11.5 / GLEAM COAL 11.5X11.5.



Textile



A series of collections whose strength resides in the texture and tactility of the surface. Our textile design proposal is inspired by different weaves in order to offer pieces full of warmth that invite you to touch them.

Una serie de colecciones donde la textura y tactilidad de la superficie es su punto fuerte. Nuestra propuesta de diseños textiles se inspiran en diferentes tejidos para ofrecer piezas llenas de calidez que invitan al tacto.

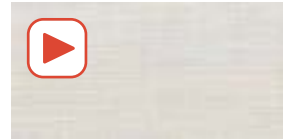

R10 V2 HABITAT WHITE RECT
30 X 60 / 12" X 24" R47/M



V2 MALLA HABITAT WHITE
30 X 30 (5 X 5) / 12" X 12" K01/P

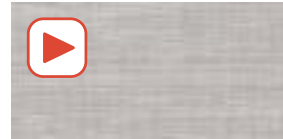

R10 V2 HABITAT SKY RECT
30 X 60 / 12" X 24" R47/M



V2 MALLA HABITAT SKY
30 X 30 (5 X 5) / 12" X 12" K01/P



R10 V2 HABITAT BLUE RECT
30 X 60 / 12" X 24" R47/M



V2 MALLA HABITAT BLUE
30 X 30 (5 X 5) / 12" X 12" K01/P



R10 V2 POCKET BLUE RECT
30 X 60 / 12" X 24" R23/M



V4 MALLA HABITAT MIX BLUE-SKY-WHITE
30 X 30 (5 X 5) / 12" X 12" K01/P

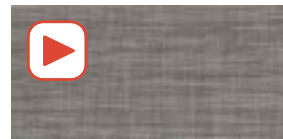

R10 V2 HABITAT GREY RECT
30 X 60 / 12" X 24" R47/M

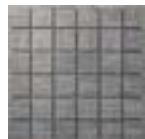

V2 MALLA HABITAT GREY
30 X 30 (5 X 5) / 12" X 12" K01/P

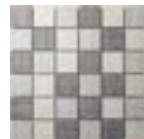

V4 MALLA HABITAT MIX GREY-SKY-WHITE
30 X 30 (5 X 5) / 12" X 12" K01/P



R10 V2 HABITAT CAPPUCCINO RECT
30 X 60 / 12" X 24" R47/M

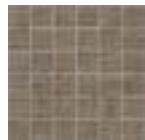

V2 MALLA HABITAT CAPPUCCINO
30 X 30 (5 X 5) / 12" X 12" K01/P



R10 V2 POCKET CAPPUCCINO RECT
30 X 60 / 12" X 24" R23/M

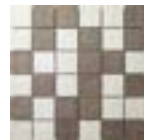

V4 MALLA HABITAT MIX CAPPUCCINO-WHITE
30 X 30 (5 X 5) / 12" X 12" K01/P



VARIACIÓN DE DISEÑO · GRAPHIC FACES

30X60 - 10 PIEZAS/10 PIECES/10 PIÈCES

CARACTERÍSTICAS TÉCNICAS · TECHNICAL CHARACTERISTICS

P PORCELÁNICO/PORCELAIN TILES
GRÉS CERÁME/FEINSTEINZEUG

RE RECTIFICADO/RECTIFIED
RECTIFIÉ/KALIBRIERT

M MATE/MATT
MAT/MATT

RU5 USO RECOMENDADO/RECOMMENED USE - RU5

FORMATO SIZE FORMAT VERPACKUNG	PZS/CAJA TILES/BOX PIÈCES/BOITE	M²/CAJA SQM/BOX MÈTRES/BOITE	KG/CAJA KG/BOX KG/BOITE	CAJAS/PALLET BOXES/PALLET BOITES/PALETTE	M²/PALLET SQM/PALLET MÈTRES/PALETTE	KG/PALLET KG/PALLET MÈTRES/PALETTE
30X60	6	1.08	25.00	40	43.20	1000
30X30	5	0.45	10.61	60	27.00	636

Para más información técnica, especificaciones e imágenes visite nuestra web y busque: Habitat
El embalaje de los artículos está sujeto a variaciones, para obtener el dato exacto y actual se recomienda consultar la web.

For more technical information, specifications and images, visit our website and search: Habitat
The packing of our items is subject to variations. To get the most accurate and updated information, we recommend to check the website.

Pour plus d'informations techniques, de spécifications et de visuels, visitez notre site web et recherchez : Habitat
L'emballage des articles est sujet à variation, pour obtenir les données exactes et actuelles il est recommandé de consulter notre site web.



POCKET BLUE RECT 30X60:HABITAT BLUE RECT 30X60



BALI DIAMOND
30 X 60 / 12" X 24" **N92/M**



BALI WATERFALL
30 X 60 / 12" X 24" **N92/M**



BALI CLOUDY
30 X 60 / 12" X 24" **N92/M**

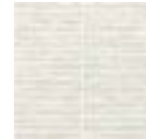

M-STICK BALI DIAMOND
30 X 30 / 12" X 12" **K08/P**



M-STICK BALI WATERFALL
30 X 30 / 12" X 12" **K08/P**



M-STICK BALI CLOUDY
30 X 30 / 12" X 12" **K08/P**



M-STICK BALI MIX COLD
30 X 30 / 12" X 12" **K08/P**



MOSAICO BALI DIAMOND
30 X 30 (5 X 5) / 12" X 12" **K01/P**



MOSAICO BALI WATERFALL
30 X 30 (5 X 5) / 12" X 12" **K01/P**



MOSAICO BALI CLOUDY
30 X 30 (5 X 5) / 12" X 12" **K01/P**



MOSAICO BALI MIX COLD
30 X 30 (5 X 5) / 12" X 12" **K01/P**



HEXAGON BALI DIAMOND
32 X 36,9 / 12,5" X 14,5" **R76/M**

RODAPÍÉS · SKIRTING BOARDS



DISPONIBLE EN TODOS LOS COLORES / AVAILABLE IN ALL COLORS



ROD, BALI CLOUDY
75 X 60 / 3" X 24" **K24/P**

CARACTERÍSTICAS TÉCNICAS · TECHNICAL CHARACTERISTICS



PORCELÁNICO/PORCELAIN TILES
GRÉS CERÁME/FEINSTEINZEUG



VARIACION LEVE/SLIGHT VARIATION
LÉGERÉ VARIATION/LEICHT FARBSPIEL



MATE/MATT
MAT/MATT



USO RECOMENDADO/RECOMMENED USE - RU5

FORMATO SIZE FORMAT VERPACKUNG	PZS/CAJA TILES/BOX PIÈCES/BOITE	M ² /CAJA SQM/BOX MÈTRES/BOITE	KG/CAJA KG/BOX KG/BOITE	CAJAS/PALLET BOXES/PALLET BOITES/PALETTE	M ² /PALLET SQM/PALLET MÈTRES/PALETTE	KG/PALLET KG/PALLET MÈTRES/PALETTE
32X36,9	10	0.89	19.53	36	31.97	703
30X60	6	1.08	25.73	40	43.20	1029
30X30	5	0.45	10.54	60	27.00	632

Para más información técnica, especificaciones e imágenes visite nuestra web y busque: Bali
El embalaje de los artículos está sujeto a variaciones, para obtener el dato exacto y actual se recomienda consultar la web.

For more technical information, specifications and images, visit our website and search: Bali
The packing of our items is subject to variations. To get the most accurate and updated information, we recommend to check the website.

Pour plus d'informations techniques, de spécifications et de visuels, visitez notre site web et recherchez : Bali
L'emballage des articles est sujet à variation, pour obtenir les données exactes et actuelles il est recommandé de consulter notre site web.



M-STICK BALI WATERFALL 30X30. BALI WATERFALL RECT. 60X60. BALI WATERFALL 30X60.



HEXAGON BALI DIAMOND 32X36,9. MOSAICO BALI WATERFALL 30X30 (5X5). BALI WATERFALL 30X60.



CLICK WHITE RECT.
40 X 120 / 16" X 48" **N51/M**



NET WHITE RECT.
40 X 120 / 16" X 48" **R32/M**



CLICK DAKAR RECT.
40 X 120 / 16" X 48" **N51/M**



NET DAKAR RECT.
40 X 120 / 16" X 48" **R32/M**



DECOR CLICK ART I WHITE
40 X 120 / 16" X 48" **K78/P**



DECOR CLICK ART II WHITE
40 X 120 / 16" X 48" **K78/P**



DECOR CLICK ART I DAKAR
40 X 120 / 16" X 48" **K78/P**



DECOR CLICK ART II DAKAR
40 X 120 / 16" X 48" **K78/P**



ZEEP WHITE RECT.
40 X 120 / 16" X 48" **R32/M**



ZEEP DAKAR RECT.
40 X 120 / 16" X 48" **R32/M**



DECOR SET(3) EXOTICA
40 X 120 / 16" X 48" **K42/P**



CLICK DAKAR RECT. 40X120 DECOR CLICK ART I DAKAR 40X120 DECOR CLICK ART II DAKAR 40X120.



CARACTERÍSTICAS TÉCNICAS · TECHNICAL CHARACTERISTICS

- PB** PASTA BLANCA / WHITE BODY
PÂTE BLANCHE / WEISSSCHERBIG
- RE** RECTIFICADO / RECTIFIED
RECTIFIÉ / KALIBRIERT
- R** REVESTIMIENTO / WALL TILE
FAÏENCE / WANDFLIESEN
- V1** ASPECTO UNIFORME / UNIFORM APPEARANCE
APPARENCE UNIFORME / KEINE FARBSPIEL
- M** MATE / MATT
MAT / MATT

FORMATO SIZE FORMAT VERPACKUNG	PZS/CAJA TILES/BOX PIÈCES/BOITE	M ² /CAJA SQM/BOX MÈTRES/BOITE	KG/CAJA KG/BOX KG/BOITE	CAJAS/PALLET BOXES/PALLET BOITES/PALETTE	M ² /PALLET SQM/PALLET MÈTRES/PALETTE	KG/PALLET KG/PALLET MÈTRES/PALETTE
40X120	3	1.44	26.60	20	28.80	532

Para más información técnica, especificaciones e imágenes visite nuestra web y busque: Click
El embalaje de los artículos está sujeto a variaciones, para obtener el dato exacto y actual se recomienda consultar la web.
For more technical information, specifications and images, visit our website and search: Click
The packing of our items is subject to variations. To get the most accurate and updated information, we recommend to check the website.
Pour plus d'informations techniques, de spécifications et de visuels, visitez notre site web et recherchez: Click
L'emballage des articles est sujet à variation, pour obtenir les données exactes et actuelles il est recommandé de consulter notre site web.



RE-USE WHITE RECT.
40 X 120 / 16" X 48" **N51/M**



MOBIUS WHITE RECT.
40 X 120 / 16" X 48" **R32/M**



RE-USE GREY RECT.
40 X 120 / 16" X 48" **N51/M**



MOBIUS GREY RECT.
40 X 120 / 16" X 48" **R32/M**



RE-USE NATURAL RECT.
40 X 120 / 16" X 48" **N51/M**



MOBIUS NATURAL RECT.
40 X 120 / 16" X 48" **R32/M**



GARY WHITE RECT.
40 X 120 / 16" X 48" **R32/M**



GARY GREY RECT.
40 X 120 / 16" X 48" **R32/M**



GARY NATURAL RECT.
40 X 120 / 16" X 48" **R32/M**

VARIACIÓN DE DISEÑO · GRAPHIC FACES

40X120 - 6 PIEZAS / 6 PIECES / 6 PIÈCES

CARACTERÍSTICAS TÉCNICAS · TECHNICAL CHARACTERISTICS

- PB** PASTA BLANCA / WHITE BODY
PÂTE BLANCHE / WEISSCHERBIG
- VI** RECTIFICADO / RECTIFIED
RECTIFIÉ / KALIBRIERT
- VI** REVESTIMIENTO / WALL TILE
FAÏENCE / WANDFLIESEN
- VI** ASPECTO UNIFORME / UNIFORM APPEARANCE
APPARENCE UNIFORME / KEINE FARBSPIEL
- M** MATE / MATT
MAT / MATT

FORMATO SIZE FORMAT VERPACKUNG	PZS/CAJA TILES/BOX PIÈCES/BOITE	M²/CAJA SQM/BOX MÈTRES/BOITE	KG/CAJA KG/BOX KG/BOITE	CAJAS/PALLET BOXES/PALLET BOITES/PALETTE	M²/PALLET SQM/PALLET MÈTRES/PALETTE	KG/PALLET KG/PALLET MÈTRES/PALETTE
40X120	3	1.44	26.95	20	28.80	539

Para más información técnica, especificaciones e imágenes visite nuestra web y busque: Re-use
El embalaje de los artículos está sujeto a variaciones, para obtener el dato exacto y actual se recomienda consultar la web.
For more technical information, specifications and images, visit our website and search: Re-use
The packing of our items is subject to variations. To get the most accurate and updated information, we recommend to check the website.
Pour plus d'informations techniques, de spécifications et de visuels, visitez notre site web et recherchez : Re-use
L'emballage des articles est sujet à variation, pour obtenir les données exactes et actuelles il est recommandé de consulter notre site web.





CRAYON WHITE RECT.
31.6 X 90 / 12.5" X 36"

R11/M

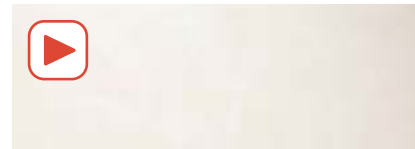

KENTIA WHITE RECT.
31.6 X 90 / 12.5" X 36"

N53/M



CRAYON SILVER RECT.
31.6 X 90 / 12.5" X 36"

R61/M



KENTIA SILVER RECT.
31.6 X 90 / 12.5" X 36"

N73/M



CRAYON GREEN RECT.
31.6 X 90 / 12.5" X 36"

R11/M



KENTIA GREEN RECT.
31.6 X 90 / 12.5" X 36"

N53/M



CRAYON BRONZE RECT.
31.6 X 90 / 12.5" X 36"

R61/M



KENTIA BRONZE RECT.
31.6 X 90 / 12.5" X 36"

N73/M



DECOR SET(2) VERGEL
31.6 X 90 / 12.5" X 36"

K78/P



KENTIA

CRAYON



CRAYON WHITE RECT. 31,6X90.DECOR SET(2) VERGEL 31,6X90

CARACTERÍSTICAS TÉCNICAS · TECHNICAL CHARACTERISTICS

- PB** PASTA BLANCA / WHITE BODY
PÂTE BLANCHE / WEISSSCHERBIG
- VI** RECTIFICADO / RECTIFIED
RECTIFIÉ / KALIBRIERT
- VI** REVESTIMIENTO / WALL TILE
FAÏENCE / WANDFLIESEN
- VI** ASPECTO UNIFORME / UNIFORM APPEARANCE
APPARENCE UNIFORME / KEINE FARBSPIEL
- B** BRILLO / SHINE
BRILLANT / GLÄNZEN

FORMATO SIZE FORMAT VERPACKUNG	PZS/CAJA TILES/BOX PIÈCES/BOITE	M ² /CAJA SQM/BOX MÈTRES/BOITE	KG/CAJA KG/BOX KG/BOITE	CAJAS/PALLET BOXES/PALLET BOITES/PALETTE	M ² /PALLET SQM/PALLET MÈTRES/PALETTE	KG/PALLET KG/PALLET MÈTRES/PALETTE
31,6X90	4	1.14	20.08	48	54.60	964

Para más información técnica, especificaciones e imágenes visite nuestra web y busque: Crayon
El embalaje de los artículos está sujeto a variaciones, para obtener el dato exacto y actual se recomienda consultar la web.
For more technical information, specifications and images, visit our website and search: Crayon
The packing of our items is subject to variations. To get the most accurate and updated information, we recommend to check the website.
Pour plus d'informations techniques, de spécifications et de visuels, visitez notre site web et recherchez: Crayon
L'emballage des articles est sujet à variation, pour obtenir les données exactes et actuelles il est recommandé de consulter notre site web.

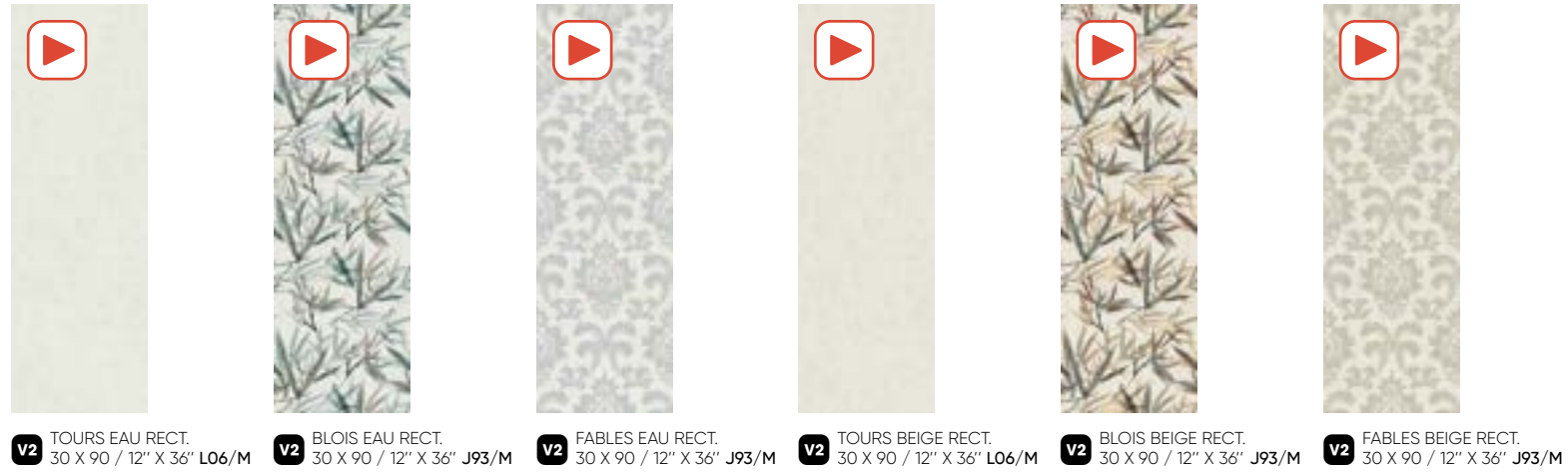

V2 ROHAN BLEU RECT. 30 X 90 / 12" X 36" J93/M
V1 BOISERIE BLANCO MATE RECT. 30 X 90 / 12" X 36" J93/M
V1 ZOCALO BLANCO MATE 15.8 X 30 / 6" X 12" K37/P

V1 MOLDURA BLANCO MATE 5 X 30 / 2" X 12" K22/P



TOURS BEIGE RECT. 30X90, BLOIS BEIGE RECT. 30X90, BOISERIE BLANCO MATE RECT. 30X90, ZOCALO BLANCO MATE 15,8X30, MOLDURA BLANCO MATE 5X30, TRIANA CAOBA RECT. 20X120

CARACTERÍSTICAS TÉCNICAS · TECHNICAL CHARACTERISTICS

- PB** PASTA BLANCA / WHITE BODY
PÂTE BLANCHE / WEISSSCHERBIG
- M** MATE / MATT
MAT / MATT
- RE** REVESTIMIENTO / WALL TILE
FAÏENCE / WANDFLIESEN
- RI** RECTIFICADO / RECTIFIED
RECTIFIÉ / KALIBRIERT

FORMATO SIZE FORMAT VERPACKUNG	PZS/CAJA TILES/BOX PIÈCES/BOITE	M²/CAJA SQM/BOX MÈTRES/BOITE	KG/CAJA KG/BOX KG/BOITE	CAJAS/PALLET BOXES/PALLET BOITES/PALETTE	M²/PALLET SQM/PALLET MÈTRES/PALETTE	KG/PALLET KG/PALLET MÈTRES/PALETTE
30X90	4	1.08	19.97	64	69.12	1278

Para más información técnica, especificaciones e imágenes visite nuestra web y busque: Fables
 El embalaje de los artículos está sujeto a variaciones, para obtener el dato exacto y actual se recomienda consultar la web.
 For more technical information, specifications and images, visit our website and search: Fables
 The packing of our items is subject to variations. To get the most accurate and updated information, we recommend to check the website.
 Pour plus d'informations techniques, de spécifications et de visuels, visitez notre site web et recherchez : Fables
 L'emballage des articles est sujet à variation, pour obtenir les données exactes et actuelles il est recommandé de consulter notre site web.



TOURS BEIGE RECT. 30X90, ROHAN BLEU RECT. 30X90, BOISERIE BLANCO MATE RECT. 30X90, MOLDURA BLANCO MATE 5X30, ZOCALO BLANCO MATE 15,8X30



Chromatic



We cannot forget the origins of ceramics, thanks to our chromatic collections that explore the possibilities of glazes and colors.

No olvidamos los orígenes cerámicos, gracias a nuestras colecciones cromáticas que exploran las posibilidades de los esmaltes y los colores.



DECOR VISAYA I RECT
120 X 260 / 48" X 102"

K98/P



DECOR VISAYA II RECT
120 X 260 / 48" X 102"

K98/P

SAP MATT RECT 60X120.TAPESTRY SAP RECT 60X120.MURUS NIX 7X28 DECOR VISAYA I 120X260.DECOR VISAYA II 120X260.PUNICE MATT RECT 60X120.CROSSSTAUPE RECT. 60X60.SAVANNAH GREY 5X25.



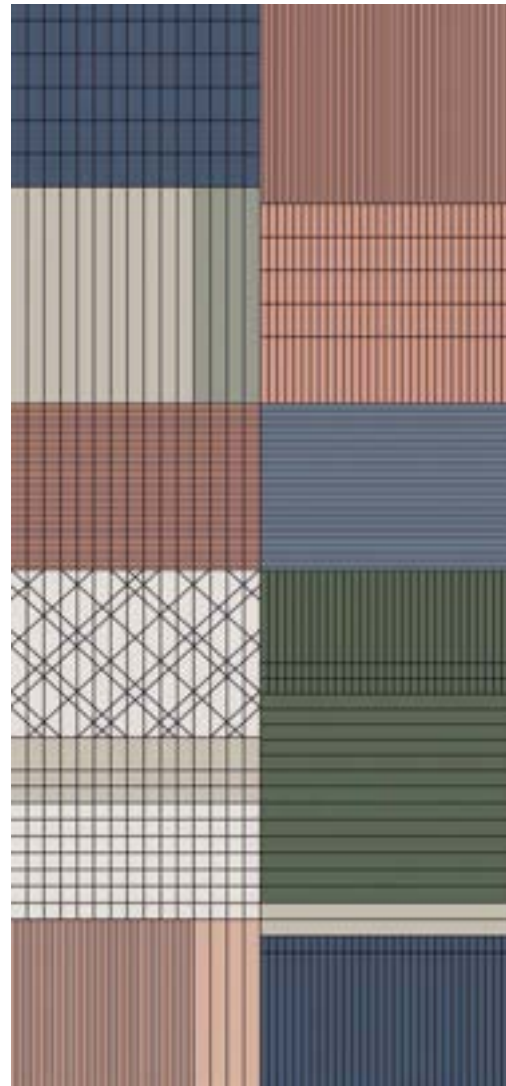

DECOR PATTERN I RECT
120 X 260 / 48" X 102"

K98/P

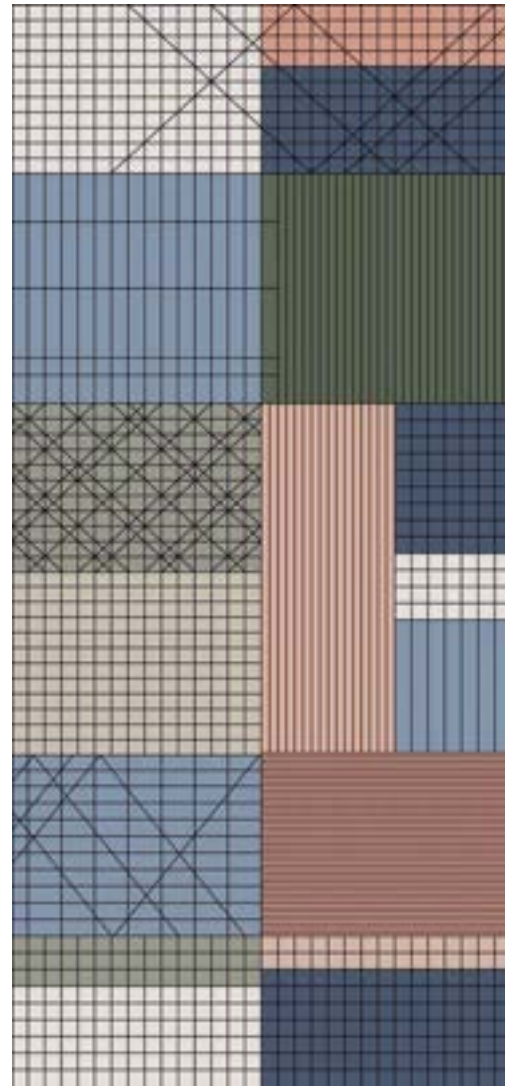

DECOR PATTERN II RECT
120 X 260 / 48" X 102"

K98/P



DECOR VASILY I RECT
120 X 260 / 48" X 102"

K98/P



DECOR VASILY II RECT
120 X 260 / 48" X 102"

K98/P

CARACTERÍSTICAS TÉCNICAS - TECHNICAL CHARACTERISTICS

- P** PORCELÁNICO/PORCELAIN TILES
GRÈS CERÁME/FEINSTEINZEUG
- M** MATE/MATT
MAT/MATT
- R** RECTIFICADO/RECTIFIED
RECTIFIÉ/KALIBRIERT
- U** ULTRAFINO/SLIM
ULTRA-MINCE/ULTRA-THIN
- V1** ASPECTO UNIFORME/UNIFORM APPEARANCE
APPARENCE UNIFORME/KEINE FARBSPIEL
- F** ANTIHIELO/FROST PROOF
RÉSISTANT AU GEL/FROSTSCHUTZ

FORMATO SIZE FORMAT VERPACKUNG	PZS/CAJA TILES/BOX PIÈCES/BOITE	M ² /CAJA SQM/BOX MÈTRES/BOITE	KG/CAJA KG/BOX KG/BOITE	CAJAS/PALLET BOXES/PALLET BOITES/PALETTE	M ² /PALLET SQM/PALLET MÈTRES/PALETTE	KG/PALLET KG/PALLET MÈTRES/PALETTE
120X260	5	15.60	253.18	2	31.20	506

Para más información técnica, especificaciones e imágenes visite nuestra web y busque: Atelier

El embalaje de los artículos está sujeto a variaciones, para obtener el dato exacto y actual se recomienda consultar la web.

For more technical information, specifications and images, visit our website and search: Atelier

The packing of our items is subject to variations. To get the most accurate and updated information, we recommend to check the website.

Pour plus d'informations techniques, de spécifications et de visuels, visitez notre site web et recherchez: Atelier

L'emballage des articles est sujet à variation, pour obtenir les données exactes et actuelles il est recommandé de consulter notre site web.

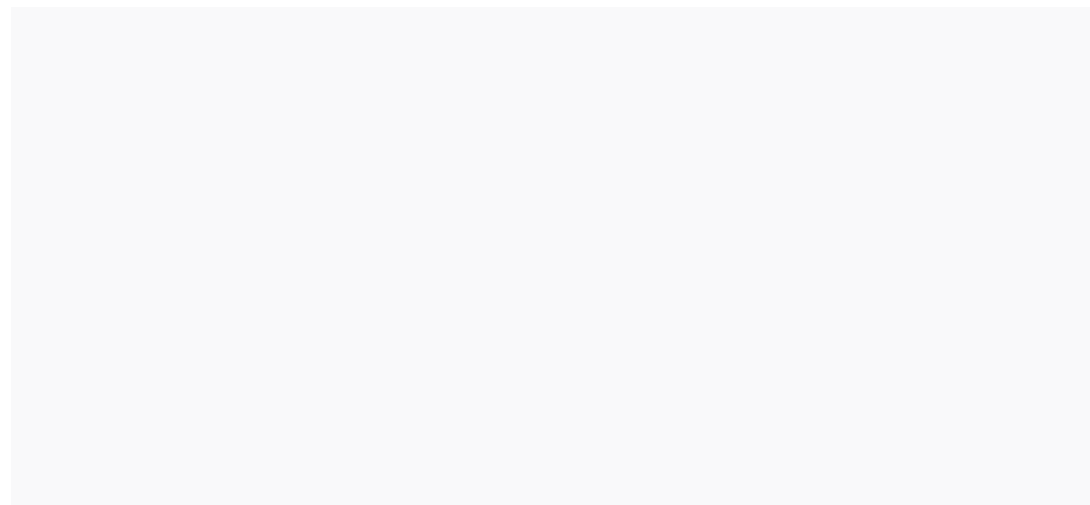

M **RU5** CHROME WHITE MATT RECT 120 X 260 / 48" X 102" J34/M

G **RU4** CHROME WHITE POLISHED RECT 120 X 260 / 48" X 102" J36/M

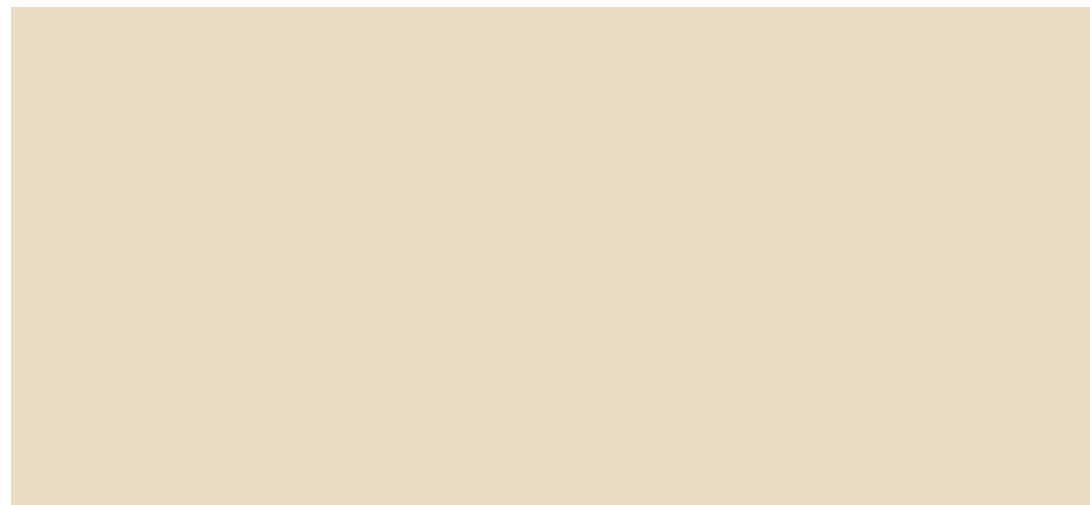

M **RU5** CHROME CREAM MATT RECT 120 X 260 / 48" X 102" J34/M

G **RU4** CHROME CREAM POLISHED RECT 120 X 260 / 48" X 102" J35/M



M **RU5** CHROME SILVER MATT RECT 120 X 260 / 48" X 102" J34/M

G **RU4** CHROME SILVER POLISHED RECT 120 X 260 / 48" X 102" J35/M



M **RU5** CHROME LEAD MATT RECT 120 X 260 / 48" X 102" J33/M

G **RU4** CHROME LEAD POLISHED RECT 120 X 260 / 48" X 102" J36/M



M **RU5** CHROME BLACK MATT RECT 120 X 260 / 48" X 102" J33/M

CARACTERÍSTICAS TÉCNICAS · TECHNICAL CHARACTERISTICS

- P** PORCELÁNICO/PORCELAIN TILES GRÉS CERÁME/FEINSTEINZEUG
- VI** ASPECTO UNIFORME/UNIFORM APPEARANCE APPARENCE UNIFORME/KEINE FARBSPIEL
- U** ULTRAFINO/SLIM ULTRA-MINCE/ULTRA-THIN
- R** RECTIFICADO/RECTIFIED RECTIFIÉ/KALIBRIERT
- S** MASA COLOREADA/COLORED BODY TEINTÉE DANS LA MASSE/DURCHGEFÄRBT
- F** ANTIHIELO/FROST PROOF RÉISTANT AU GEL/FROSTSCHUTZ

FORMATO SIZE FORMAT VERPACKUNG	PZS/CAJA TILES/BOX PIÈCES/BOITE	M²/CAJA SQM/BOX MÈTRES/BOITE	KG/CAJA KG/BOX KG/BOITE	CAJAS/PALLET BOXES/PALLET BOITES/PALETTE	M²/PALLET SQM/PALLET MÈTRES/PALETTE	KG/PALLET KG/PALLET MÈTRES/PALETTE
120X260	1	3.12	45.19	21	65.52	949

Para más información técnica, especificaciones e imágenes visite nuestra web y busque: Chrome
 El embalaje de los artículos está sujeto a variaciones, para obtener el dato exacto y actual se recomienda consultar la web.
 For more technical information, specifications and images, visit our website and search: Chrome
 The packing of our items is subject to variations. To get the most accurate and updated information, we recommend to check the website.
 Pour plus d'informations techniques, de spécifications et de visuels, visitez notre site web et recherchez: Chrome
 L'emballage des articles est sujet à variation, pour obtenir les données exactes et actuelles il est recommandé de consulter notre site web.



V2 MATERIA BLACK LAPATTO RECT.
80 X 80 / 32" X 32" **J26/M**



V2 MATERIA BLACK LAPATTO RECT.
60 X 60 / 24" X 24" **R58/M**



V2 DECOR MATERIA SILVER
30 X 60 / 12" X 24" **K55/P**



V1 LIENZO BLACK LAPATTO RECT.
80 X 80 / 32" X 32" **N60/M**



V1 LIENZO BLACK LAPATTO RECT.
60 X 60 / 24" X 24" **R58/M**



V2 TRAZOS MIX BLACK LAPATTO RECT.
60 X 60 / 24" X 24" **R58/M**



V2 MATERIA WHITE LAPATTO RECT.
80 X 80 / 32" X 32" **J26/M**



V2 MATERIA WHITE LAPATTO RECT.
60 X 60 / 24" X 24" **R58/M**



V2 DECOR MATERIA GOLD
30 X 60 / 12" X 24" **K55/P**

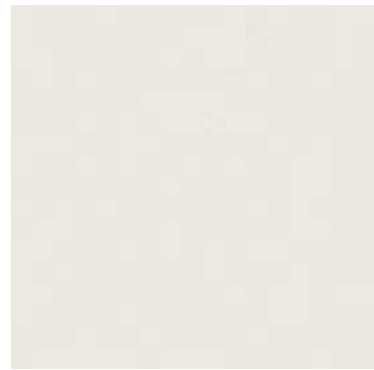

V1 LIENZO WHITE LAPATTO RECT.
80 X 80 / 32" X 32" **N60/M**

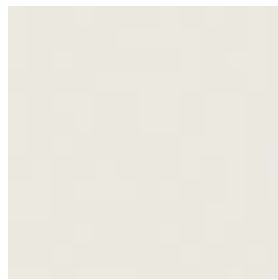

V1 LIENZO WHITE LAPATTO RECT.
60 X 60 / 24" X 24" **R58/M**

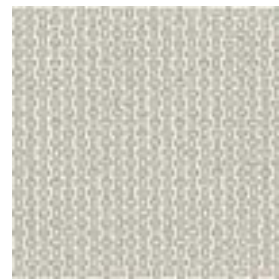

V2 TRAZOS MIX WHITE LAPATTO RECT.
60 X 60 / 24" X 24" **R58/M**



RODAPIÉS · SKIRTING BOARDS



DISPONIBLE EN TODOS LOS COLORES / AVAILABLE IN ALL COLORS



V2 ROD. MATERIA LAPATTO
7.5 X 60 / 3" X 24" **K24/P**

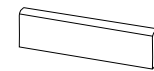

V1 ROD. LIENZO LAPATTO
7.5 X 60 / 3" X 24" **K24/P**

V2 ROD. MATERIA LAPATTO
7.5 X 80 / 3" X 32" **K21/P**

V1 ROD. LIENZO LAPATTO
7.5 X 80 / 3" X 32" **K21/P**

CARACTERÍSTICAS TÉCNICAS · TECHNICAL CHARACTERISTICS

P PORCELÁNICO / PORCELAIN TILES
GRÈS CERÁME / FEINSTEINZEUG

MASA COLOREADA / COLORED BODY
TEINTÉE DANS LA MASSE / DURCHGEFÄRBT

LAPATTO / LAPPED
LAPATTO / TEILPOLIERT

ANTIHIELO / FROST PROOF
RÉSISTANT AU GEL / FROSTSCHUTZ

RECTIFICADO / RECTIFIED
RECTIFIÉ / KALIBRIERT

USO RECOMENDADO / RECOMMENED USE - RU5

FORMATO SIZE FORMAT VERPACKUNG	PZS/CAJA TILES/BOX PIÈCES/BOITE	M ² /CAJA SQM/BOX MÈTRES/BOITE	KG/CAJA KG/BOX KG/BOITE	CAJAS/PALLET BOXES/PALLET BOITES/PALETTE	M ² /PALLET SQM/PALLET MÈTRES/PALETTE	KG/PALLET KG/PALLET MÈTRES/PALETTE
80X80	2	1.28	35.00	44	56.32	1540
60X60	3	1.08	25.63	32	34.56	820
30X60	5	0.90	20.47	40	36.00	819

Para más información técnica, especificaciones e imágenes visite nuestra web y busque: Materia
El embalaje de los artículos está sujeto a variaciones, para obtener el dato exacto y actual se recomienda consultar la web.

For more technical information, specifications and images, visit our website and search: Materia
The packing of our items is subject to variations. To get the most accurate and updated information, we recommend to check the website.

Pour plus d'informations techniques, de spécifications et de visuels, visitez notre site web et recherchez: Materia
L'emballage des articles est sujet à variation, pour obtenir les données exactes et actuelles il est recommandé de consulter notre site web.



M V1 RU5 TERRACOTTA MATT RECT
60 X 120 / 24" X 48" J53/M



M V1 RU5 SAP MATT RECT
60 X 120 / 24" X 48" J53/M

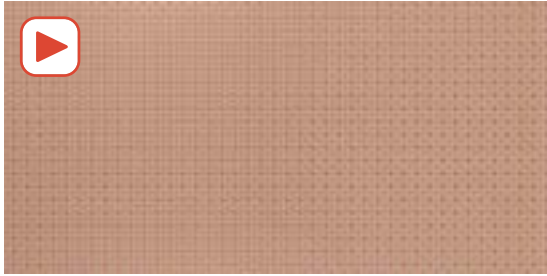

M V1 RU5 TAPESTRY TERRACOTTA RECT
60 X 120 / 24" X 48" J94/M

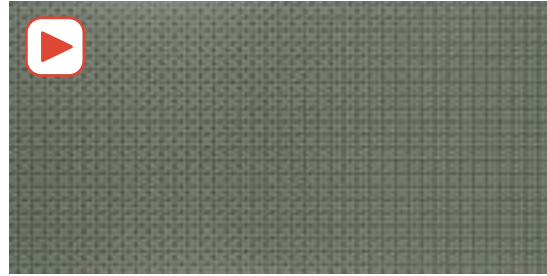

M V1 RU5 TAPESTRY SAP RECT
60 X 120 / 24" X 48" J94/M



G V2 RU4 FIOR DI PESCO POL RECT
60 X 120 / 24" X 48" P34/M



G V2 RU4 JADORE POL RECT
60 X 120 / 24" X 48" P34/M

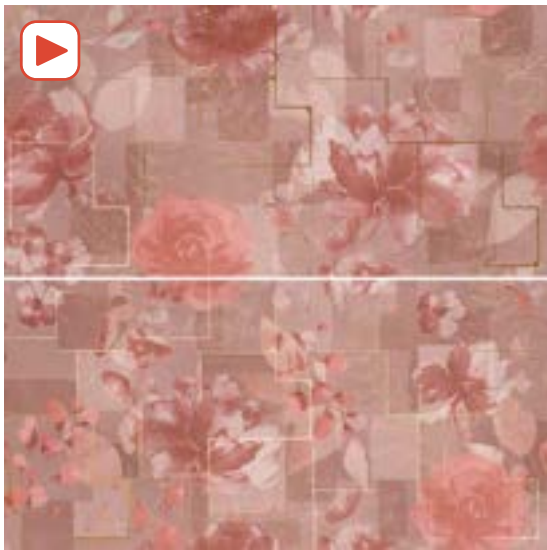

M V1 RU5 DECOR SET(2) SUMMER
60 X 120 / 24" X 48" K95/P

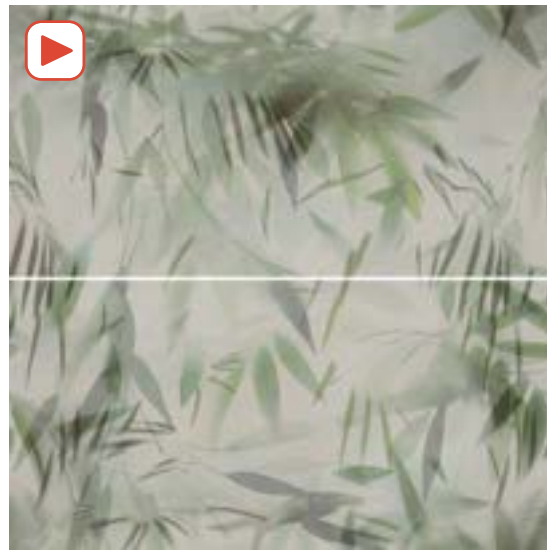

M V1 RU5 DECOR SET(2) SPRING
60 X 120 / 24" X 48" K95/P

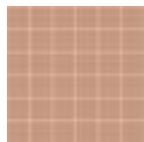

M V1 RU5 MOSAICO TERRACOTA
30 X 30 (5 X 5) / 12" X 12" K01/P

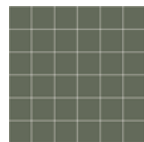

M V1 RU5 MOSAICO SAP
30 X 30 (5 X 5) / 12" X 12" K01/P



SAP MATT RECT 60X120 TAPESTRY SAP RECT 60X120 MURUS NIX 7X28



M V1 RU5 PUMICE MATT RECT
60 X 120 / 24" X 48" J53/M



M V1 RU5 TAPESTRY PUMICE RECT
60 X 120 / 24" X 48" J94/M



G V4 RU4 DEDALUS POL RECT
60 X 120 / 24" X 48" P34/M

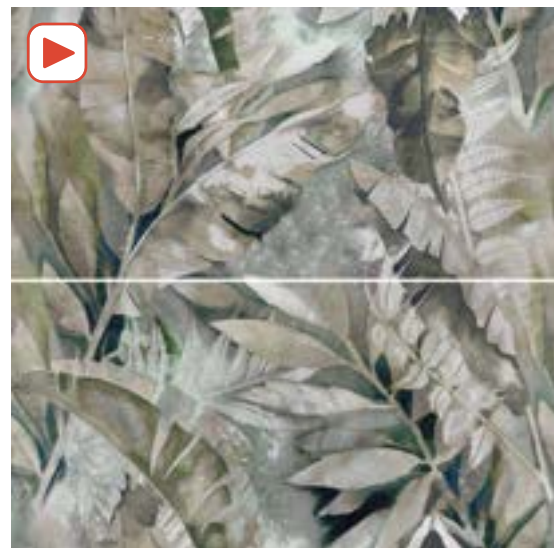

M V1 RU5 DECOR SET(2) WINTER
60 X 120 / 24" X 48" K95/P



M V1 RU5 MOSAICO PUMICE
30 X 30 (5 X 5) / 12" X 12" K01/P



M V1 RU5 WOAD MATT RECT
60 X 120 / 24" X 48" J53/M



M V1 RU5 TAPESTRY WOAD RECT
60 X 120 / 24" X 48" J94/M



G V3 RU4 BLUE EXPLOSION POL RECT
60 X 120 / 24" X 48" P34/M

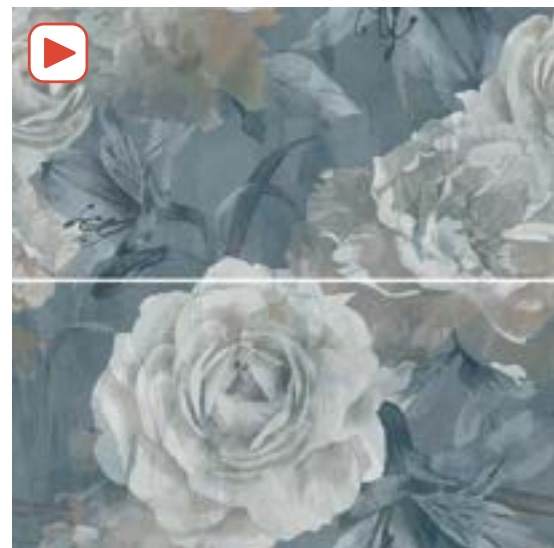

M V1 RU5 DECOR SET(2) AUTUMN
60 X 120 / 24" X 48" K95/P



M V1 RU5 MOSAICO WOAD
30 X 30 (5 X 5) / 12" X 12" K01/P



DECOR SET(2) WINTER 60X120:TAPESTRY PUMICE RECT 60X120:PUMICE MATT RECT 60X120



PAVIMENTO RECOMENDADO · RECOMMENDED FLOORING **P** **V2**



***B RU5** EPOCA WHITE SILKEN RECT.
60 X 60 / 24" X 24" J54/M

E RU4 EPOCA WHITE POL RECT.
60 X 60 / 24" X 24" J92/M



***B RU5** EPOCA GREY SILKEN RECT.
60 X 60 / 24" X 24" J54/M

E RU4 EPOCA GREY POL RECT.
60 X 60 / 24" X 24" J92/M



***B RU5** EPOCA BONE SILKEN RECT.
60 X 60 / 24" X 24" J54/M

E RU4 EPOCA BONE POL RECT.
60 X 60 / 24" X 24" J92/M

CARACTERÍSTICAS TÉCNICAS · TECHNICAL CHARACTERISTICS

P PORCELÁNICO / PORCELAIN TILES
GRÈS CERÁME / FEINSTEINZEUG **RECTIFICADO / RECTIFIED**
RECTIFIÉ / KALIBRIERT

FORMATO SIZE FORMAT VERPACKUNG	PZS/CAJA TILES/BOX PIÈCES/BOITE	M ² /CAJA SQM/BOX MÈTRES/BOITE	KG/CAJA KG/BOX KG/BOITE	CAJAS/PALLET BOXES/PALLET BOITES/PALETTE	M ² /PALLET SQM/PALLET MÈTRES/PALETTE	KG/PALLET KG/PALLET MÈTRES/PALETTE
60X120	2	1.43	31.27	30	42.98	938
30X30	5	0.45	9.40	60	27.00	564

Para más información técnica, especificaciones e imágenes visite nuestra web y busque: Four seasons
El embalaje de los artículos está sujeto a variaciones, para obtener el dato exacto y actual se recomienda consultar la web.
For more technical information, specifications and images, visit our website and search: Four seasons
The packing of our items is subject to variations. To get the most accurate and updated information, we recommend to check the website.
Pour plus d'informations techniques, de spécifications et de visuels, visitez notre site web et recherchez: Four seasons
L'emballage des articles est sujet à variation, pour obtenir les données exactes et actuelles il est recommandé de consulter notre site web.

Montblanc

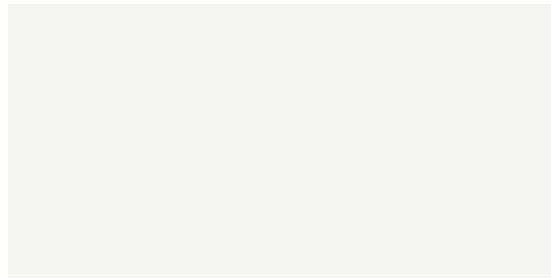

M **RU5** MONTBLANC WHITE MATT RECT
60 X 120 / 24" X 48" **N77/M**

E **RU4** MONTBLANC WHITE POLISHED RECT
60 X 120 / 24" X 48" **N62/M**

RODAPIÉS · SKIRTING BOARDS

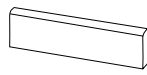

M ROD. MONTBLANC MATT
75 X 60 / 3" X 24" **K24/P**

E ROD. MONTBLANC POL.
75 X 60 / 3" X 24" **K29/P**

CARACTERÍSTICAS TÉCNICAS · TECHNICAL CHARACTERISTICS

- P** PORCELÁNICO/PORCELAIN TILES
GRÉS CERÁME/FEINSTEINZEUG
- V1** ASPECTO UNIFORME/UNIFORM APPEARANCE
APPARENCE UNIFORME/KEINE FARBSPIEL
- E** RECTIFICADO/RECTIFIED
RECTIFIÉ/KALIBRIERT
- S** ANTIHIELO/FROST PROOF
RÉSISTANT AU GEL/FROSTSCHUTZ

FORMATO SIZE FORMAT VERPACKUNG	PZS/CAJA TILES/BOX PIÈCES/BOITE	M²/CAJA SQM/BOX MÈTRES/BOITE	KG/CAJA KG/BOX KG/BOITE	CAJAS/PALLET BOXES/PALLET BOITES/PALETTE	M²/PALLET SQM/PALLET MÈTRES/PALETTE	KG/PALLET KG/PALLET MÈTRES/PALETTE
60X120	2	1.44	34.16	32	46.08	1093

Para más información técnica, especificaciones e imágenes visite nuestra web y busque: Montblanc
El embalaje de los artículos está sujeto a variaciones, para obtener el dato exacto y actual se recomienda consultar la web.

For more technical information, specifications and images, visit our website and search: Montblanc
The packing of our items is subject to variations. To get the most accurate and updated information, we recommend to check the website.

Pour plus d'informations techniques, de spécifications et de visuels, visitez notre site web et recherchez : Montblanc
L'emballage des articles est sujet à variation, pour obtenir les données exactes et actuelles il est recommandé de consulter notre site web.

Crystal



CRYSTAL WHITE POLISHED RECT.
75 X 75 / 30" X 30" **R83/M**

RODAPIÉS · SKIRTING BOARDS

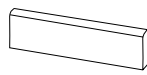

ROD. CRYSTAL WHITE POL.
75 X 75 / 3" X 30" **K21/P**

CARACTERÍSTICAS TÉCNICAS · TECHNICAL CHARACTERISTICS

- P** PORCELÁNICO/PORCELAIN TILES
GRÉS CERÁME/FEINSTEINZEUG
- V1** ASPECTO UNIFORME/UNIFORM APPEARANCE
APPARENCE UNIFORME/KEINE FARBSPIEL
- E** ESMALTE PULIDO/GLAZE POLISHED SHINY
ÉMAIL POLI BRILLANT/HOCHGLANZ POLIERT
- S** ANTIHIELO/FROST PROOF
RÉSISTANT AU GEL/FROSTSCHUTZ
- RU4** USO RECOMENDADO/RECOMMENED USE - RU4

FORMATO SIZE FORMAT VERPACKUNG	PZS/CAJA TILES/BOX PIÈCES/BOITE	M²/CAJA SQM/BOX MÈTRES/BOITE	KG/CAJA KG/BOX KG/BOITE	CAJAS/PALLET BOXES/PALLET BOITES/PALETTE	M²/PALLET SQM/PALLET MÈTRES/PALETTE	KG/PALLET KG/PALLET MÈTRES/PALETTE
75X75	2	1.11	24.90	42	46.62	1046

Para más información técnica, especificaciones e imágenes visite nuestra web y busque: Crystal
El embalaje de los artículos está sujeto a variaciones, para obtener el dato exacto y actual se recomienda consultar la web.

For more technical information, specifications and images, visit our website and search: Crystal
The packing of our items is subject to variations. To get the most accurate and updated information, we recommend to check the website.

Pour plus d'informations techniques, de spécifications et de visuels, visitez notre site web et recherchez : Crystal
L'emballage des articles est sujet à variation, pour obtenir les données exactes et actuelles il est recommandé de consulter notre site web.

Epoca



***B** **RU5** EPOCA BONE SILKEN RECT.
60 X 60 / 24" X 24" **J54/M**

E **RU4** EPOCA BONE POL RECT.
60 X 60 / 24" X 24" **J92/M**



***B** **RU5** EPOCA GREY SILKEN RECT.
60 X 60 / 24" X 24" **J54/M**

E **RU4** EPOCA GREY POL RECT.
60 X 60 / 24" X 24" **J92/M**



***B** **RU5** EPOCA WHITE SILKEN RECT.
60 X 60 / 24" X 24" **J54/M**

E **RU4** EPOCA WHITE POL RECT.
60 X 60 / 24" X 24" **J92/M**

CARACTERÍSTICAS TÉCNICAS · TECHNICAL CHARACTERISTICS

- P** PORCELÁNICO/PORCELAIN TILES
GRÉS CERÁME/FEINSTEINZEUG
- V2** VARIACION LEVE/SLIGHT VARIATION
LÉGERÉ VARIATION/LEICHT FARBSPIEL
- E** RECTIFICADO/RECTIFIED
RECTIFIÉ/KALIBRIERT
- S** ANTIHIELO/FROST PROOF
RÉSISTANT AU GEL/FROSTSCHUTZ

FORMATO SIZE FORMAT VERPACKUNG	PZS/CAJA TILES/BOX PIÈCES/BOITE	M²/CAJA SQM/BOX MÈTRES/BOITE	KG/CAJA KG/BOX KG/BOITE	CAJAS/PALLET BOXES/PALLET BOITES/PALETTE	M²/PALLET SQM/PALLET MÈTRES/PALETTE	KG/PALLET KG/PALLET MÈTRES/PALETTE
60X60	3	1.07	22.33	40	42.91	893

Para más información técnica, especificaciones e imágenes visite nuestra web y busque: Epoca
El embalaje de los artículos está sujeto a variaciones, para obtener el dato exacto y actual se recomienda consultar la web.

For more technical information, specifications and images, visit our website and search: Epoca
The packing of our items is subject to variations. To get the most accurate and updated information, we recommend to check the website.

Pour plus d'informations techniques, de spécifications et de visuels, visitez notre site web et recherchez : Epoca
L'emballage des articles est sujet à variation, pour obtenir les données exactes et actuelles il est recommandé de consulter notre site web.



Studio

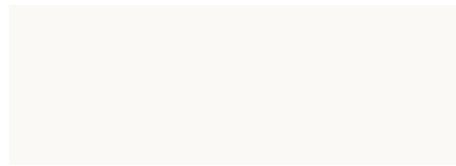

STUDIO WHITE RECT.
35 X 100 / 14" X 40" **NS4/M**



LAKE WHITE RECT.
35 X 100 / 14" X 40" **R63/M**



SCALA WHITE RECT.
35 X 100 / 14" X 40" **R63/M**



STUDIO BLACK RECT.
35 X 100 / 14" X 40" **R63/M**

CARACTERÍSTICAS TÉCNICAS · TECHNICAL CHARACTERISTICS

- PB** PASTA BLANCA/WHITE BODY
PÂTE BLANCHE/WEISSSCHERBIG
- E** RECTIFICADO/RECTIFIED
RECTIFIÉ/KALIBRIERT
- S** REVESTIMIENTO/WALL TILE
FAÏENCE/WANDFLIESEN
- V1** ASPECTO UNIFORME/UNIFORM APPEARANCE
APPARENCE UNIFORME/KEINE FARBSPIEL
- *B** BRILLO/SHINE
BRILLANT/GLÄNZEN

FORMATO SIZE FORMAT VERPACKUNG	PZS/CAJA TILES/BOX PIÈCES/BOITE	M²/CAJA SQM/BOX MÈTRES/BOITE	KG/CAJA KG/BOX KG/BOITE	CAJAS/PALLET BOXES/PALLET BOITES/PALETTE	M²/PALLET SQM/PALLET MÈTRES/PALETTE	KG/PALLET KG/PALLET MÈTRES/PALETTE
35X100	3	1.05	18.89	28	29.40	529

Para más información técnica, especificaciones e imágenes visite nuestra web y busque: Studio
El embalaje de los artículos está sujeto a variaciones, para obtener el dato exacto y actual se recomienda consultar la web.

For more technical information, specifications and images, visit our website and search: Studio
The packing of our items is subject to variations. To get the most accurate and updated information, we recommend to check the website.

Pour plus d'informations techniques, de spécifications et de visuels, visitez notre site web et recherchez : Studio
L'emballage des articles est sujet à variation, pour obtenir les données exactes et actuelles il est recommandé de consulter notre site web.



M **V1** **RU5** FORTUNE MATT RECT
60 X 120 / 24" X 48" L11/M

E **V1** **RU4** FORTUNE POL. RECT
60 X 120 / 24" X 48" L13/M

MOLDURA FORTUNE MATT
2 X 60 / 0.8" X 24" K17/P



M **RU5** MOSAICO FORTUNE MATT
30 X 30 (5 X 5) / 12" X 12" K01/P



E **RU5** MALLA TEAR FORTUNE MIX
37.3 X 24.5 / 15" X 10" K49/P



M **V2** **RU5** CALACATTA SLOW MATT RECT
60 X 120 / 24" X 48" R60/M

E **V2** **RU4** CALACATTA SLOW POL RECT
60 X 120 / 24" X 48" J18/M

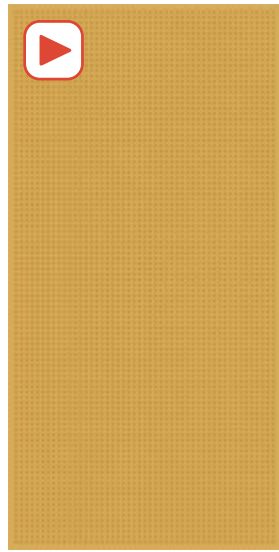

***B** **V1** **RU4** WICKER FORTUNE RECT.
60 X 120 / 24" X 48" L16/M



M **V1** DECOR WALLPAPER TIDE RECT
60 X 120 / 24" X 48" K68/P



M **V2** **RU5** HEXAGON CALACATTA SLOW
13.9 X 16 / 5.5" X 6.3" N70/M

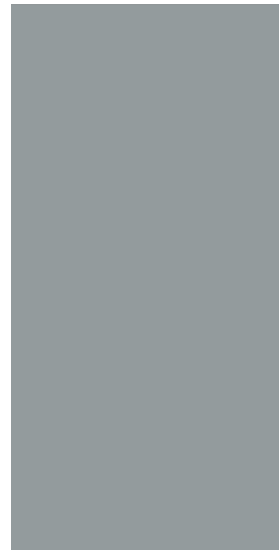

M **V1** **RU5** LEAD MATT RECT
60 X 120 / 24" X 48" J53/M

E **V1** **RU4** LEAD POL. RECT
60 X 120 / 24" X 48" J89/M

MOLDURA LEAD MATT
2 X 60 / 0.8" X 24" K17/P

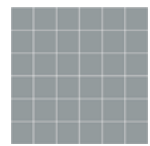

M **RU5** MOSAICO LEAD MATT
30 X 30 (5 X 5) / 12" X 12" K01/P



E **RU5** MALLA TEAR LEAD MIX
37.3 X 24.5 / 15" X 10" K49/P



***B** **V2** **RU5** HEXA BOHO CALACATTA SLOW
13.9 X 16 / 5.5" X 6.3" L07/M

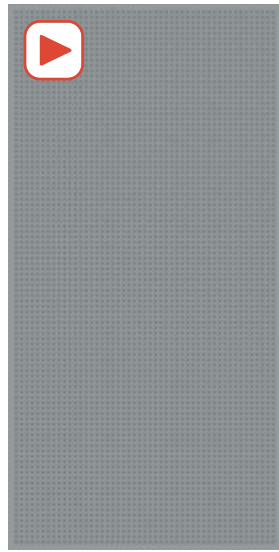

***B** **V1** **RU4** WICKER LEAD RECT.
60 X 120 / 24" X 48" J94/M



E **V1** **RU4** DAMASCUS POL. RECT
60 X 120 / 24" X 48" L15/M



***B** **V1** CRETONNE FORTUNE RECT
60 X 120 / 24" X 48" J94/M

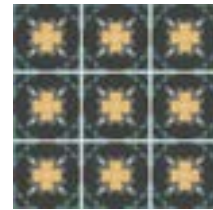

M **C2** **R10** **V1** **RU5** DAHLIA NIGHT
15 X 15 / 6" X 6"

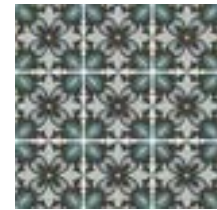

M **C2** **R10** **V1** **RU5** DAISY NIGHT
15 X 15 / 6" X 6"

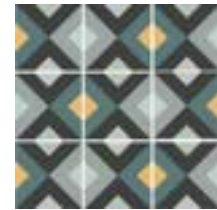

M **C2** **R10** **V1** **RU5** JASMINE NIGHT
15 X 15 / 6" X 6"

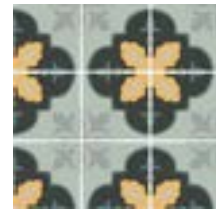

M **C2** **R10** **V1** **RU5** VIOLET NIGHT
15 X 15 / 6" X 6"

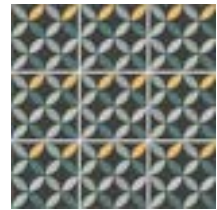

M **C2** **R10** **V1** **RU5** PANSY NIGHT
15 X 15 / 6" X 6" L33/M



M **C2** **R10** **V3** **RU5** NUANCES LEAD RECT
20 X 120 / 8" X 48" R53/M



M **C2** **R10** **V2** **RU5** NUANCES NATURAL RECT
20 X 120 / 8" X 48" R53/M



LEAD MATT RECT. 60X120. MOLDURA LEAD MATT. 2X60. MALLA TEAR LEAD MIX. 37.3X24.5.

CARACTERÍSTICAS TÉCNICAS · TECHNICAL CHARACTERISTICS

P PORCELÁNICO/PORCELAIN TILES
GRÉS CERÁME/FEINSTEINZEUG

E ANTIHIELO/FROST PROOF
RÉSISTANT AU GEL/FROSTSCHUTZ

FORMATO SIZE FORMAT VERPACKUNG	PZS/CAJA TILES/BOX PIÈCES/BOITE	M²/CAJA SQM/BOX MÈTRES/BOITE	KG/CAJA KG/BOX KG/BOITE	CAJAS/PALLET BOXES/PALLET BOITES/PALETTE	M²/PALLET SQM/PALLET MÈTRES/PALETTE	KG/PALLET KG/PALLET MÈTRES/PALETTE
60X120	2	1.43	32.77	30	42.98	983
20X120	6	1.44	33.14	44	63.36	1458
15X15	22	0.50	9.56	120	59.40	1147
13,9X16	20	0.33	6.79	105	34.65	713

Para más información técnica, especificaciones e imágenes visite nuestra web y busque: Tonality

El embalaje de los artículos está sujeto a variaciones, para obtener el dato exacto y actual se recomienda consultar la web.

For more technical information, specifications and images, visit our website and search: Tonality

The packing of our items is subject to variations. To get the most accurate and updated information, we recommend to check the website.

Pour plus d'informations techniques, de spécifications et de visuels, visitez notre site web et recherchez: Tonality

L'emballage des articles est sujet à variation, pour obtenir les données exactes et actuelles il est recommandé de consulter notre site web.



M **V1** **RU5** TIDE MATT RECT
60 X 120 / 24" X 48" L11/M



***B** **V1** **RU4** WICKER TIDE RECT.
60 X 120 / 24" X 48" L16/M

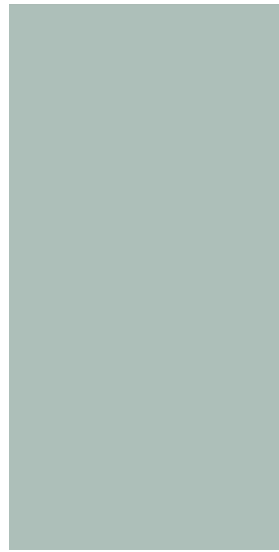

M **V1** **RU5** TURQUOISE MATT RECT
60 X 120 / 24" X 48" J53/M

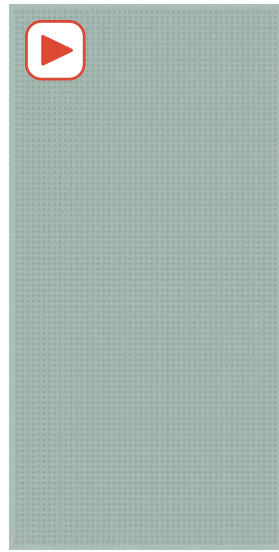

***B** **V1** **RU4** WICKER TURQUOISE RECT.
60 X 120 / 24" X 48" J94/M

E **V1** **RU4** TIDE POL. RECT
60 X 120 / 24" X 48" L13/M

E **V1** **RU4** TURQUOISE POL. RECT
60 X 120 / 24" X 48" J89/M

MOLDURA TIDE MATT
2 X 60 / 0.8" X 24" K17/P

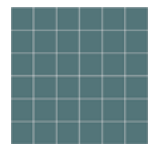

M **RU5** MOSAICO TIDE MATT
30 X 30 (5 X 5) / 12" X 12" K01/P



E **RU5** MALLA TEAR TIDE MIX
37.3 X 24.5 / 15" X 10" K49/P



M **V1** DECOR WALLPAPER TIDE RECT
60 X 120 / 24" X 48" K68/P

MOLDURA TURQUOISE MATT
2 X 60 / 0.8" X 24" K17/P

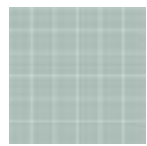

M **RU5** MOSAICO TURQUOISE MATT
30 X 30 (5 X 5) / 12" X 12" K01/P



E **RU5** MALLA TEAR TURQUOISE MIX
37.3 X 24.5 / 15" X 10" K49/P



E **V1** **RU4** TINT TURQUOISE POL. RECT
60 X 120 / 24" X 48" L35/M



M **V2** **RU5** ONYX SLOW MATT RECT
60 X 120 / 24" X 48" R60/M

E **V2** **RU4** ONYX SLOW POL RECT
60 X 120 / 24" X 48" J18/M



M **V2** **RU5** HEXAGON ONYX SLOW
13.9 X 16 / 5.5" X 6.3" N70/M



***B** **V2** **RU5** HEXA BOHO ONYX SLOW
13.9 X 16 / 5.5" X 6.3" L07/M



***B** **V1** CRETONNE TIDE RECT
60 X 120 / 24" X 48" J94/M

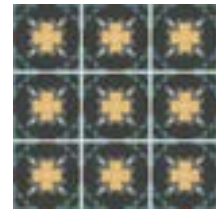

M **C2** **R10** **V1** **RU5** DAHLIA NIGHT
15 X 15 / 6" X 6"

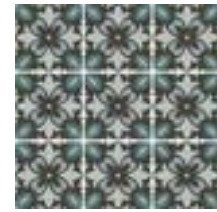

M **C2** **R10** **V1** **RU5** DAISY NIGHT
15 X 15 / 6" X 6"

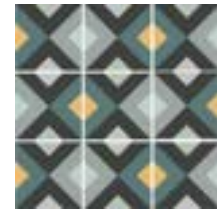

M **C2** **R10** **V1** **RU5** JASMINE NIGHT
15 X 15 / 6" X 6"



M **C2** **R10** **V1** **RU5** VIOLET NIGHT
15 X 15 / 6" X 6"

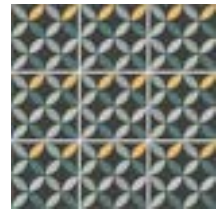

M **C2** **R10** **V1** **RU5** PANSY NIGHT
15 X 15 / 6" X 6" L33/M



M **C2** **R10** **V3** **RU5** NUANCES TURQUOISE RECT
20 X 120 / 8" X 48" R53/M



M **C2** **R10** **V2** **RU5** NUANCES NATURAL RECT
20 X 120 / 8" X 48" R53/M

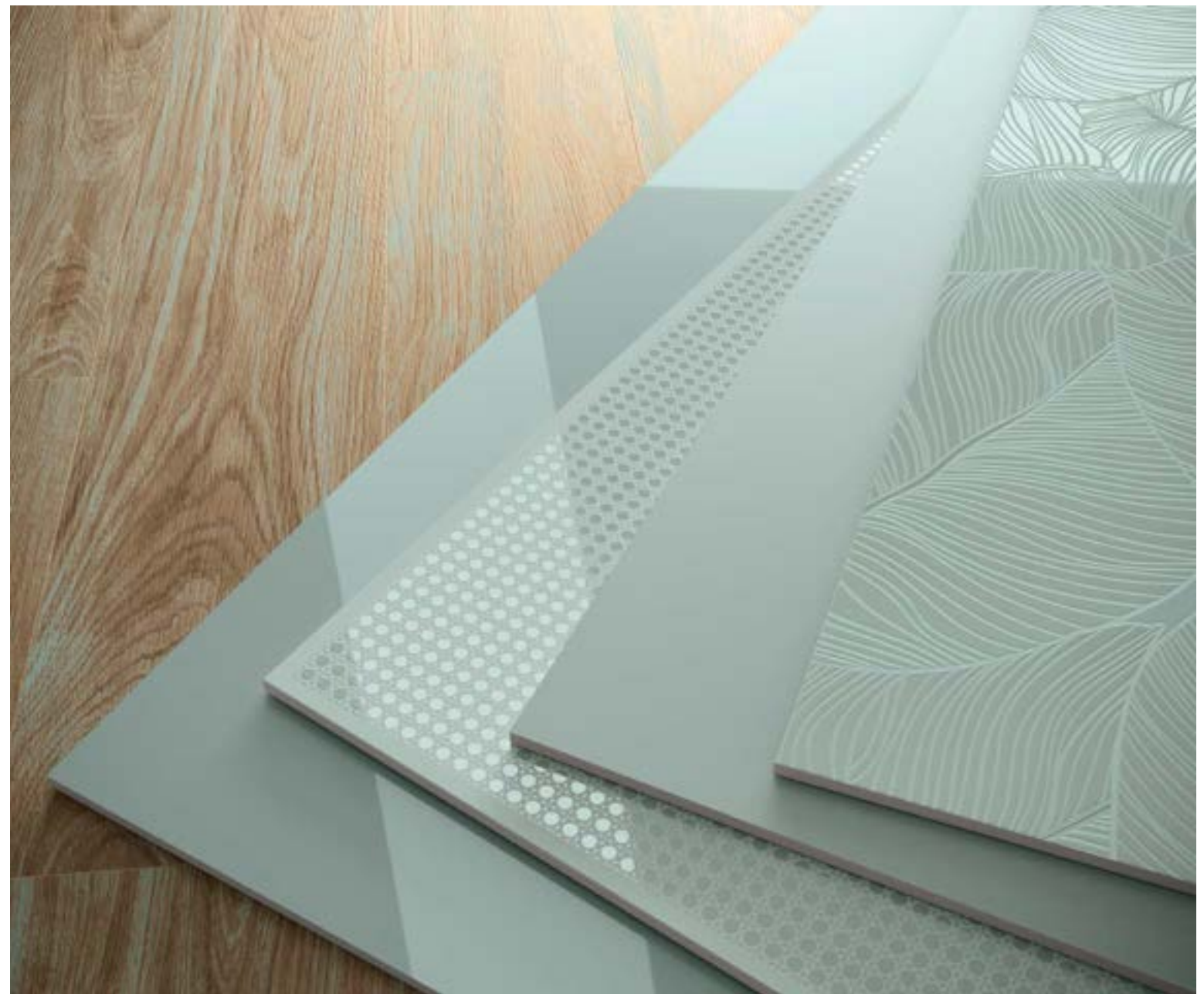

TURQUOISE POL. RECT. 60X120. TINT TURQUOISE POL. RECT. 60X120. TURQUOISE MATT 60X120.

Tonality

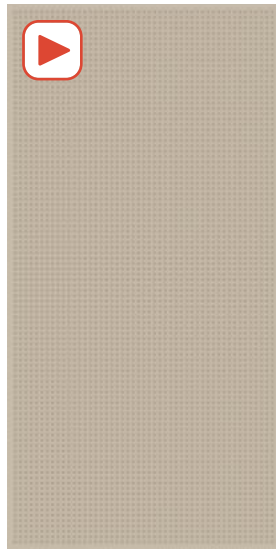

M **V1** **RU5** CHAMPAGNE MATT RECT
60 X 120 / 24" X 48" J53/M

***B** **V1** **RU4** WICKER CHAMPAGNE RECT.
60 X 120 / 24" X 48" J94/M

E **V1** **RU4** CHAMPAGNE POL. RECT
60 X 120 / 24" X 48" J89/M

MOLDURA CHAMPAGNE MATT
2 X 60 / 0.8" X 24" K17/P

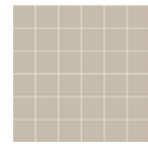

M **RU5** MOSAICO CHAMPAGNE MATT
30 X 30 (5 X 5) / 12" X 12" K01/P



E **RU5** MALLA TEAR CHAMPAGNE MIX
37.3 X 24.5 / 15" X 10" K49/P



***B** **V1** CRETONNE ROUGE RECT
60 X 120 / 24" X 48" J94/M

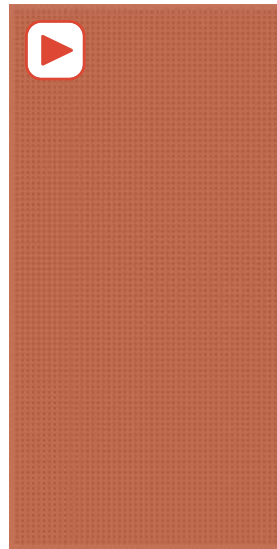

M **V1** **RU5** ROUGE MATT RECT
60 X 120 / 24" X 48" L12/M

***B** **V1** **RU4** WICKER ROUGE RECT.
60 X 120 / 24" X 48" L27/M

E **V1** **RU4** ROUGE POL. RECT
60 X 120 / 24" X 48" L14/M

MOLDURA ROUGE MATT
2 X 60 / 0.8" X 24" K17/P



M **RU5** MOSAICO ROUGE MATT
30 X 30 (5 X 5) / 12" X 12" K01/P



E **RU5** MALLA TEAR ROUGE MIX
37.3 X 24.5 / 15" X 10" K49/P



M **V1** DECOR WALLPAPER ROUGE RECT
60 X 120 / 24" X 48" K68/P



ROUGE MATT RECT 60X120, ROUGE POL. RECT 60X120,
MOLDURA ROUGE MATT 2X60, DECOR WALLPAPER ROUGE RECT 60X120.

Tonality / Chromatic

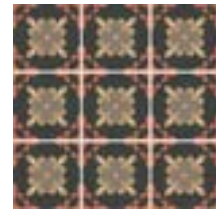

M **C2** **R10** **V1** **RU5** DAHLIA DAY
15 X 15 / 6" X 6" L33/M



M **C2** **R10** **V1** **RU5** DAISY DAY
15 X 15 / 6" X 6" L33/M



M **C2** **R10** **V1** **RU5** JASMINE DAY
15 X 15 / 6" X 6"



M **C2** **R10** **V1** **RU5** VIOLET DAY
15 X 15 / 6" X 6"

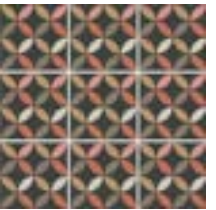

M **C2** **R10** **V1** **RU5** PANSY DAY
15 X 15



M **C2** **R10** **V2** **RU5** NUANCES NATURAL RECT
20 X 120 / 8" X 48" R53/M



DAHLIA DAY 15X15, ROUGE MATT RECT 60X120.

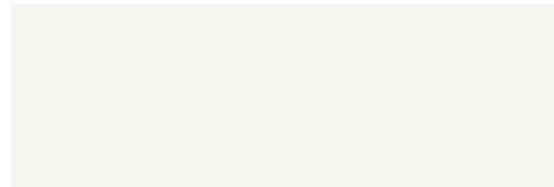

M V1 OH LA LA WHITE RECT.
40 X 120 / 16" X 48" P98/M



M V1 MAMA MIA WHITE RECT.
40 X 120 / 16" X 48" R32/M



M V1 OLE WHITE RECT.
40 X 120 / 16" X 48" R32/M

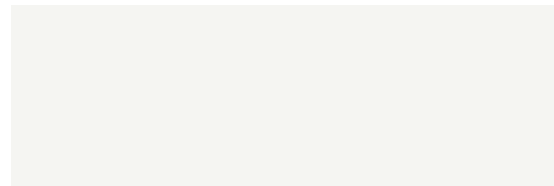

***B V1** OH YEAH WHITE RECT.
40 X 120 / 16" X 48" P98/M



***B V1** FOLD WHITE RECT.
40 X 120 / 16" X 48" R32/M



M V3 KI CARAMELLO RECT.
40 X 120 / 16" X 48" R32/M



M V3 KI MIELE RECT.
40 X 120 / 16" X 48" R32/M



M V3 KI NATURALE RECT.
40 X 120 / 16" X 48" R32/M



M V3 KI CENERE RECT.
40 X 120 / 16" X 48" R32/M



M V2 DECOR SET(2) LOST PARADISE BLUE
40 X 120 / 16" X 48" K72/P



M V2 DECOR SET(3) ABC BIBA GRAPHITE
40 X 120 / 16" X 48" K81/P



M V2 DECOR SET(2) LOST PARADISE GREEN
40 X 120 / 16" X 48" K72/P



M V2 DECOR SET(3) DEF BIBA GRAPHITE
40 X 120 / 16" X 48" K81/P



DECOR SET(2) LOST PARADISE GREEN 40X120. PANAMA RECT. 60X120. HARLEQUIN WHITE 10X20.



M V2 DECOR SET(3) ABC TOUCAN OCRE
40 X 120 / 16" X 48" K81/P



M V2 DECOR SET(3) ABC TOUCAN BLUE
40 X 120 / 16" X 48" K81/P



M V2 DECOR SET(3) ABC TOUCAN GREEN
40 X 120 / 16" X 48" K81/P



M V2 DECOR SET(3) ABC VIRNIA TURQUOISE
40 X 120 / 16" X 48" K81/P



M V2 DECOR SET(3) DEF TOUCAN OCRE
40 X 120 / 16" X 48" K81/P



M V2 DECOR SET(3) DEF TOUCAN BLUE
40 X 120 / 16" X 48" K81/P



M V2 DECOR SET(3) DEF TOUCAN GREEN
40 X 120 / 16" X 48" K81/P



M V2 DECOR SET(3) DEF VIRNIA TURQUOISE
40 X 120 / 16" X 48" K81/P



DECOR SET(3) TOUCAN OCRE 40X120.

CARACTERÍSTICAS TÉCNICAS · TECHNICAL CHARACTERISTICS



PASTA BLANCA / WHITE BODY
PÂTE BLANCHE / WEISSSCHERBIG



RECTIFICADO / RECTIFIED
RECTIFIÉ / KALIBRIERT



REVESTIMIENTO / WALL TILE
FAÏENCE / WANDFLIESEN

FORMATO SIZE FORMAT VERPACKUNG	PZS/CAJA TILES/BOX PIÈCES/BOITE	M ² /CAJA SQM/BOX MÈTRES/BOITE	KG/CAJA KG/BOX KG/BOITE	CAJAS/PALLET BOXES/PALLET BOITES/PALETTE	M ² /PALLET SQM/PALLET MÈTRES/PALETTE	KG/PALLET KG/PALLET MÈTRES/PALETTE
40X120	3	1.44	26.40	20	28.80	528

Para más información técnica, especificaciones e imágenes visite nuestra web y busque: Silk

El embalaje de los artículos está sujeto a variaciones, para obtener el dato exacto y actual se recomienda consultar la web.

For more technical information, specifications and images, visit our website and search: Silk

The packing of our items is subject to variations. To get the most accurate and updated information, we recommend to check the website.

Pour plus d'informations techniques, de spécifications et de visuels, visitez notre site web et recherchez: Silk

L'emballage des articles est sujet à variation, pour obtenir les données exactes et actuelles il est recommandé de consulter notre site web.

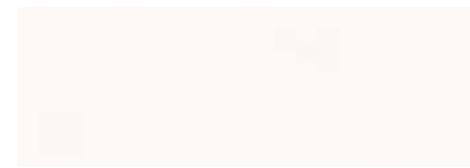

CLOUD WHITE RECT.
35 X 100 / 14" X 40" **N54/M**



CLOUD BLUE RECT.
35 X 100 / 14" X 40" **N54/M**



CLOUD GOLD RECT.
35 X 100 / 14" X 40" **N54/M**



CLOUD TURQUOISE RECT.
35 X 100 / 14" X 40" **N54/M**

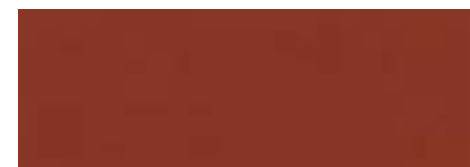

CLOUD RED RECT.
35 X 100 / 14" X 40" **N54/M**

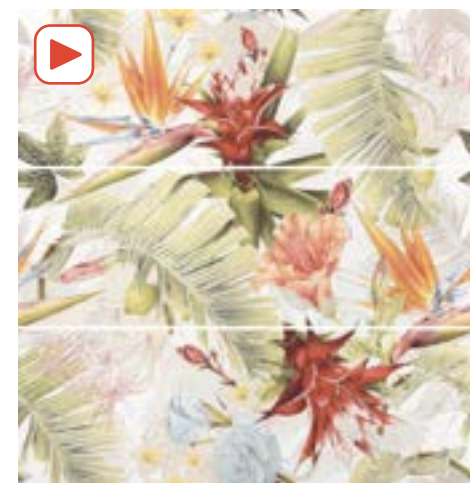

DECOR SET(3) CLOUD
35 X 100 / 14" X 40" **K78/P**

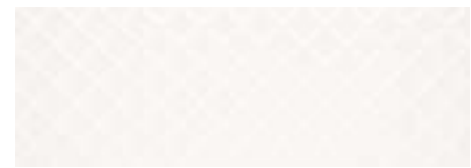

ULTRA WHITE RECT.
35 X 100 / 14" X 40" **R63/M**



ULTRA BLUE RECT.
35 X 100 / 14" X 40" **R63/M**



ULTRA GOLD RECT.
35 X 100 / 14" X 40" **R63/M**



ULTRA TURQUOISE RECT.
35 X 100 / 14" X 40" **R63/M**

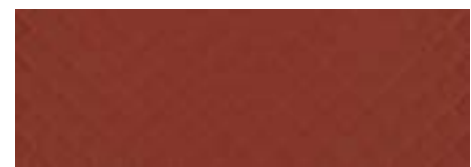

ULTRA RED RECT.
35 X 100 / 14" X 40" **R63/M**

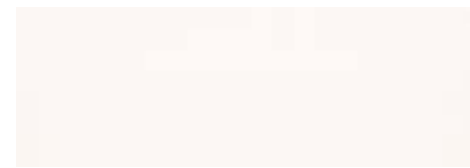

CODE WHITE RECT.
35 X 100 / 14" X 40" **R63/M**



DECOR GRAVITY BLUE
35 X 100 / 14" X 40" **K78/P**



DECOR GRAVITY MULTI
35 X 100 / 14" X 40" **K78/P**



PAINT WHITE MIX RECT.
35 X 100 / 14" X 40" **R63/M**



CLOUD TURQUOISE RECT. 35X100. CODE WHITE RECT. 35X100.



CARACTERÍSTICAS TÉCNICAS · TECHNICAL CHARACTERISTICS

- PB** PASTA BLANCA / WHITE BODY
PÂTE BLANCHE / WEISSSCHERBIG
- RE** RECTIFICADO / RECTIFIED
RECTIFIÉ / KALIBRIERT
- VI** REVESTIMIENTO / WALL TILE
FAÏENCE / WANDFLIESEN
- AS** ASPECTO UNIFORME / UNIFORM APPEARANCE
APPARENCE UNIFORME / KEINE FARBSPIEL
- M** MATE / MATT
MAT / MATT

FORMATO SIZE FORMAT VERPACKUNG	PZS/CAJA TILES/BOX PIÈCES/BOITE	M ² /CAJA SQM/BOX MÈTRES/BOITE	KG/CAJA KG/BOX KG/BOITE	CAJAS/PALLET BOXES/PALLET BOITES/PALETTE	M ² /PALLET SQM/PALLET MÈTRES/PALETTE	KG/PALLET KG/PALLET MÈTRES/PALETTE
35X100	3	1.05	20.12	26	27.30	523

Para más información técnica, especificaciones e imágenes visite nuestra web y busque: Cloud
El embalaje de los artículos está sujeto a variaciones, para obtener el dato exacto y actual se recomienda consultar la web.
For more technical information, specifications and images, visit our website and search: Cloud
The packing of our items is subject to variations. To get the most accurate and updated information, we recommend to check the website.
Pour plus d'informations techniques, de spécifications et de visuels, visitez notre site web et recherchez: Cloud
L'emballage des articles est sujet à variation, pour obtenir les données exactes et actuelles il est recommandé de consulter notre site web.



ALLEGRA WHITE RECT.
31.6 X 90 / 12.5" X 36" **R11/M**



TINA WHITE RECT.
31.6 X 90 / 12.5" X 36" **N53/M**



DECOR LINK WHITE
31.6 X 90 / 12.5" X 36" **K53/P**



ALLEGRA GREY RECT.
31.6 X 90 / 12.5" X 36" **R11/M**



TINA GREY RECT.
31.6 X 90 / 12.5" X 36" **N53/M**



DECOR LINK GREY
31.6 X 90 / 12.5" X 36" **K53/P**



ALLEGRA TURQUOISE RECT.
31.6 X 90 / 12.5" X 36" **R61/M**



TINA TURQUOISE RECT.
31.6 X 90 / 12.5" X 36" **N73/M**



DECOR LINK TURQUOISE
31.6 X 90 / 12.5" X 36" **K53/P**



ALLEGRA RED RECT.
31.6 X 90 / 12.5" X 36" **R61/M**



TINA RED RECT.
31.6 X 90 / 12.5" X 36" **N73/M**



DECOR LINK RED
31.6 X 90 / 12.5" X 36" **K53/P**



ALLEGRA

TINA

CARACTERÍSTICAS TÉCNICAS · TECHNICAL CHARACTERISTICS



PASTA BLANCA / WHITE BODY
PÂTE BLANCHE / WEISSCHERBIG



RECTIFICADO / RECTIFIED
RECTIFIÉ / KALIBRIERT



REVESTIMIENTO / WALL TILE
FAÏENCE / WANDFLIESEN



ASPECTO UNIFORME / UNIFORM APPEARANCE
APPARENCE UNIFORME / KEINE FARBSPIEL



BRILLO / SHINE
BRILLANT / GLÄNZEN

FORMATO SIZE FORMAT VERPACKUNG	PZS/CAJA TILES/BOX PIÈCES/BOITE	M²/CAJA SQM/BOX MÈTRES/BOITE	KG/CAJA KG/BOX KG/BOITE	CAJAS/PALLET BOXES/PALLET BOITES/PALETTE	M²/PALLET SQM/PALLET MÈTRES/PALETTE	KG/PALLET KG/PALLET MÈTRES/PALETTE
31,6X90	4	1.14	20.60	48	54.60	989

Para más información técnica, especificaciones e imágenes visite nuestra web y busque: Allegra
El embalaje de los artículos está sujeto a variaciones, para obtener el dato exacto y actual se recomienda consultar la web.

For more technical information, specifications and images, visit our website and search: Allegra
The packing of our items is subject to variations. To get the most accurate and updated information, we recommend to check the website.

Pour plus d'informations techniques, de spécifications et de visuels, visitez notre site web et recherchez : Allegra
L'emballage des articles est sujet à variation, pour obtenir les données exactes et actuelles il est recommandé de consulter notre site web.



ALLEGRA WHITE RECT. 31,6X90.TINA WHITE RECT.31,6X90



M V1 ALL WHITE MATT RECT.
30 X 90 / 12" X 36" P61/M



***B V1** ALL WHITE SHINE RECT.
30 X 90 / 12" X 36" P61/M

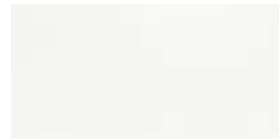

M V1 ALL WHITE MATT RECT.
30 X 60 / 12" X 24" R70/M



***B V1** ALL WHITE SHINE RECT.
30 X 60 / 12" X 24" R70/M



M V2 STEP GRIS RECT.
30 X 90 / 12" X 36" N52/M



M V2 STEP NOGAL RECT.
30 X 90 / 12" X 36" N52/M



M V2 STEP ROBLE RECT.
30 X 90 / 12" X 36" N52/M

* Pavimentos Recomendados / Recommended Floor Tiles :
Oregon

* Pavimentos Recomendados / Recommended Floor Tiles :
Triana

M V1 MOLDURA BLANCO MATE
5 X 30 / 2" X 12" K22/P



M V1 BOISERIE BLANCO MATE RECT.
30 X 90 / 12" X 36" J93/M

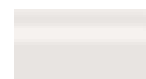

M V1 ZOCCALO BLANCO MATE
15.8 X 30 / 6" X 12" K37/P



STEP NOGAL

CARACTERÍSTICAS TÉCNICAS · TECHNICAL CHARACTERISTICS

PB PASTA BLANCA/WHITE BODY
PÂTE BLANCHE/WEISSSCHERBIG

RE RECTIFICADO/RECTIFIED
RECTIFIÉ/KALIBRIERT

RE REVESTIMIENTO/WALL TILE
FAIENCE/WANDFLIESEN

FORMATO SIZE FORMAT VERPACKUNG	PZS/CAJA TILES/BOX PIÈCES/BOITE	M ² /CAJA SQM/BOX MÈTRES/BOITE	KG/CAJA KG/BOX KG/BOITE	CAJAS/PALLET BOXES/PALLET BOITES/PALETTE	M ² /PALLET SQM/PALLET MÈTRES/PALETTE	KG/PALLET KG/PALLET MÈTRES/PALETTE
30X90	4	1.08	19.50	64	69.12	1248
30X60	6	1.08	16.86	40	43.20	674

Para más información técnica, especificaciones e imágenes visite nuestra web y busque: All white
El embalaje de los artículos está sujeto a variaciones, para obtener el dato exacto y actual se recomienda consultar la web.

For more technical information, specifications and images, visit our website and search: All white
The packing of our items is subject to variations. To get the most accurate and updated information, we recommend to check the website.

Pour plus d'informations techniques, de spécifications et de visuels, visitez notre site web et recherchez : All white
L'emballage des articles est sujet à variation, pour obtenir les données exactes et actuelles il est recommandé de consulter notre site web.

ALL WHITE MATT RECT. 30X60 STEP NOGAL RECT. 30X90.

ALL WHITE SHINE RECT. 30X60 FLAMENCO PERLA RECT. 20X120.





*B V1 MOMA BIANCO 20 X 60 / 8" X 24" J14/M	M V1 ORSAY BIANCO 20 X 60 / 8" X 24" J14/M	M V1 MINA BIANCO 20 X 60 / 8" X 24" J12/M	M V1 ANOUK BIANCO 20 X 60 / 8" X 24" J12/M	M V1 ODETTE BIANCO 20 X 60 / 8" X 24" J12/M
M V2 UMBER SABBIA 20 X 60 / 8" X 24" J12/M	M V2 UMBER SANDALO 20 X 60 / 8" X 24" J12/M	M V2 UMBER GRIGIO 20 X 60 / 8" X 24" J12/M		

* Pavimentos Recomendados / Recommended Floor Tiles :
Apalache



ORSAY BLANCO 20X60, ANOUK BLANCO 20X60.



ORSAY BLANCO 20X60, UMBER SANDALO 20X60, KOEN CENERE MATT, RECT. 20X120.

CARACTERÍSTICAS TÉCNICAS · TECHNICAL CHARACTERISTICS

PB PASTA BLANCA/WHITE BODY
PÂTE BLANCHE/WEISSSCHERBIG

REVESTIMIENTO/WALL TILE
FAÏENCE/WANDFLIESEN

FORMATO SIZE FORMAT VERPACKUNG	PZS/CAJA TILES/BOX PIÈCES/BOITE	M²/CAJA SQM/BOX MÈTRES/BOITE	KG/CAJA KG/BOX KG/BOITE	CAJAS/PALLET BOXES/PALLET BOITES/PALETTE	M²/PALLET SQM/PALLET MÈTRES/PALETTE	KG/PALLET KG/PALLET MÈTRES/PALETTE
20X60	10	1.20	17.94	64	76.80	1148

Para más información técnica, especificaciones e imágenes visite nuestra web y busque: Orsay
El embalaje de los artículos está sujeto a variaciones, para obtener el dato exacto y actual se recomienda consultar la web.

For more technical information, specifications and images, visit our website and search: Orsay
The packing of our items is subject to variations. To get the most accurate and updated information, we recommend to check the website.

Pour plus d'informations techniques, de spécifications et de visuels, visitez notre site web et recherchez : Orsay
L'emballage des articles est sujet à variation, pour obtenir les données exactes et actuelles il est recommandé de consulter notre site web.



ARTS WHITE
20 X 50 / 8" X 20" N17/M



ARTS GREY
20 X 50 / 8" X 20" N17/M



ARTS NUDE
20 X 50 / 8" X 20" N17/M



ARTS TURQUOISE
20 X 50 / 8" X 20" N17/M



ARTS BLUE
20 X 50 / 8" X 20" N17/M



DECOR ARTS I WHITE
20 X 50 / 8" X 20" K64/P



DECOR AKA I WHITE
20 X 50 / 8" X 20" K64/P



TRENDY MIX
20 X 50 / 8" X 20" N06/M



TIP WHITE
20 X 50 / 8" X 20" N06/M



TIP GREY
20 X 50 / 8" X 20" N06/M



TIP NUDE
20 X 50 / 8" X 20" N06/M



TIP TURQUOISE
20 X 50 / 8" X 20" N06/M



TIP BLUE
20 X 50 / 8" X 20" N06/M



DECOR ARTS II WHITE
20 X 50 / 8" X 20" K64/P



DECOR AKA II WHITE
20 X 50 / 8" X 20" K64/P



TRENDY BLACK
20 X 50 / 8" X 20" N06/M



POP WHITE
20 X 50 / 8" X 20" N06/M



POP GREY
20 X 50 / 8" X 20" N06/M



POP NUDE
20 X 50 / 8" X 20" N06/M



POP TURQUOISE
20 X 50 / 8" X 20" N06/M



POP BLUE
20 X 50 / 8" X 20" N06/M



DECOR ARTS III WHITE
20 X 50 / 8" X 20" K64/P



DECOR AKA III WHITE
20 X 50 / 8" X 20" K64/P



DECOR RAIN WHITE
20 X 50 / 8" X 20" K16/P

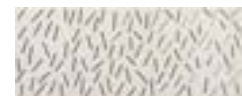

DECOR RAIN GREY
20 X 50 / 8" X 20" K16/P



DECOR RAIN NUDE
20 X 50 / 8" X 20" K16/P



DECOR RAIN TURQUOISE
20 X 50 / 8" X 20" K16/P



DECOR RAIN BLUE
20 X 50 / 8" X 20" K16/P

P M V2 RU5



TRENDY MIX
20 X 20 / 8" X 8" P95/M

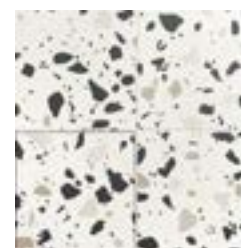

TRENDY BLACK
20 X 20 / 8" X 8" P95/M



ARTS BLUE 20X50.TRENDY MIX 20X20.



CARACTERÍSTICAS TÉCNICAS · TECHNICAL CHARACTERISTICS

- PR** PASTA ROJA / RED BODY
PÂTE ROUGE / ROTSCHERBIG
- M** MATE / MATT
MAT / MATT
- V1** REVESTIMIENTO / WALL TILE
FAÏENCE / WANDFLIESEN
- V2** ASPECTO UNIFORME / UNIFORM APPEARANCE
APPARENCE UNIFORME / KEINE FARBSPIEL

FORMATO SIZE FORMAT VERPACKUNG	PZS/CAJA TILES/BOX PIÈCES/BOITE	M ² /CAJA SQM/BOX MÈTRES/BOITE	KG/CAJA KG/BOX KG/BOITE	CAJAS/PALLET BOXES/PALLET BOITES/PALETTE	M ² /PALLET SQM/PALLET MÈTRES/PALETTE	KG/PALLET KG/PALLET MÈTRES/PALETTE
20X50	14	1.40	20.44	48	67.20	981

Para más información técnica, especificaciones e imágenes visite nuestra web y busque: Arts
El embalaje de los artículos está sujeto a variaciones, para obtener el dato exacto y actual se recomienda consultar la web.
For more technical information, specifications and images, visit our website and search: Arts
The packing of our items is subject to variations. To get the most accurate and updated information, we recommend to check the website.
Pour plus d'informations techniques, de spécifications et de visuels, visitez notre site web et recherchez: Arts
L'emballage des articles est sujet à variation, pour obtenir les données exactes et actuelles il est recommandé de consulter notre site web.



BLISS WHITE 20 X 60 / 8" X 24" L08/M	BLISS ORANGE 20 X 60 / 8" X 24" L09/M	BLISS RED 20 X 60 / 8" X 24" L30/M	BLISS BLUE 20 X 60 / 8" X 24" L09/M	BLISS GREEN 20 X 60 / 8" X 24" L09/M
SCRAPE WHITE 20 X 60 / 8" X 24" L10/M	SCRAPE ORANGE 20 X 60 / 8" X 24" L10/M	SCRAPE RED 20 X 60 / 8" X 24" L31/M	SCRAPE BLUE 20 X 60 / 8" X 24" L10/M	SCRAPE GREEN 20 X 60 / 8" X 24" L10/M
DECOR PLUM I 20 X 60 / 8" X 24" K60/P	DECOR PLUM II 20 X 60 / 8" X 24" K60/P	DECOR SET(2) HORTENSIA 20 X 60 / 8" X 24" K60/P	DECOR SET(2) CALAS 20 X 60 / 8" X 24" K60/P	
DECOR SET(2) BLISS 20 X 60 / 8" X 24" K60/P				

BLISS ORANGE 20X60.SCRAPE ORANGE 20X60.NUANCES NATURAL RECT.20X120



CARACTERÍSTICAS TÉCNICAS · TECHNICAL CHARACTERISTICS

- PR** PASTA ROJA / RED BODY
PÂTE ROUGE / ROTSCHERBIG
- B** BRILLO / SHINE
BRILLANT / GLÄNZEN
- V2** VARIACION LEVE / SLIGHT VARIATION
LÉGERE VARIATION / LEICHT FARBSPIEL
- REVESTIMIENTO / WALL TILE**
FAÏENCE / WANDFLIESEN

FORMATO SIZE FORMAT VERPACKUNG	PZS/CAJA TILES/BOX PIÈCES/BOITE	M²/CAJA SQM/BOX MÈTRES/BOITE	KG/CAJA KG/BOX KG/BOITE	CAJAS/PALLET BOXES/PALLET BOITES/PALETTE	M²/PALLET SQM/PALLET MÈTRES/PALETTE	KG/PALLET KG/PALLET MÈTRES/PALETTE
20X60	12	1.44	21.98	48	69.12	1055













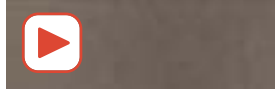

Para más información técnica, especificaciones e imágenes visite nuestra web y busque: Bliss
El embalaje de los artículos está sujeto a variaciones, para obtener el dato exacto y actual se recomienda consultar la web.
For more technical information, specifications and images, visit our website and search: Bliss
The packing of our items is subject to variations. To get the most accurate and updated information, we recommend to check the website.
Pour plus d'informations techniques, de spécifications et de visuels, visitez notre site web et recherchez : Bliss
L'emballage des articles est sujet à variation, pour obtenir les données exactes et actuelles il est recommandé de consulter notre site web.

VARIACIÓN DE DISEÑO · GRAPHIC FACES

- 20X60 BLISS - 12 PIEZAS/12 PIECES/12 PIÈCES
- 20X60 SCRAPE - 4 PIEZAS/4 PIECES/4 PIÈCES

BLISS BLUE 20X60.SCRAPE BLUE 20X60.NUANCES NATURAL RECT.20X120

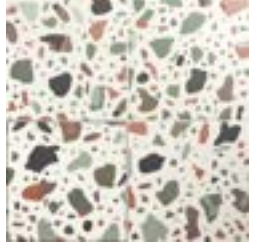
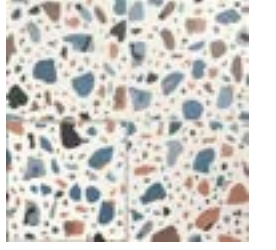

 STAY WHITE 20 X 60 / 8" X 24" L08/M	 STAY TERRACOTA 20 X 60 / 8" X 24" L09/M	 STAY GREEN 20 X 60 / 8" X 24" L09/M	 STAY BLUE 20 X 60 / 8" X 24" L09/M	 STAY SMOKE 20 X 60 / 8" X 24" L30/M
 JUK WHITE 20 X 60 / 8" X 24" L10/M	 JUK TERRACOTA 20 X 60 / 8" X 24" L10/M	 JUK GREEN 20 X 60 / 8" X 24" L10/M	 JUK BLUE 20 X 60 / 8" X 24" L10/M	 JUK SMOKE 20 X 60 / 8" X 24" L10/M
 DECOR GRAPE 20 X 60 / 8" X 24" K60/P	 ISLA GREEN MIX 20 X 60 / 8" X 24" L10/M	 ISLA BLUE MIX 20 X 60 / 8" X 24" L10/M	 DECOR SET(3) STAY WHITE 20 X 60 / 8" X 24" K60/P	
 ISLA GREEN MIX 20 X 20 / 8" X 8" P95/M		 ISLA BLUE MIX 20 X 20 / 8" X 8" P95/M		



PB **V1** **RUS** HEXAGON NICE WHITE
23 X 26 / 9" X 10" N14/M



PB **V4** **RUS** HEXAGON NICE MIX
23 X 26 / 9" X 10" R73/M

VARIACIÓN DE DISEÑO · GRAPHIC FACES

20X60 - 6 PIEZAS/6 PIECES/6 PIÈCES
20X20 - 20 PIEZAS/20 PIECES/20 PIÈCES

CARACTERÍSTICAS TÉCNICAS · TECHNICAL CHARACTERISTICS

- PR** PASTA ROJA/ RED BODY / PÂTE ROUGE/ROTSCHERBIG
- M** MATE/MATT / MAT/MATT
- V2** REVESTIMIENTO/WALL TILE / FAÏENCE/WANDFLIESEN
- V1** VARIACION LEVE/SLIGHT VARIATION / LÉGERE VARIATION / LEICHT FARBSPIEL

FORMATO SIZE FORMAT VERPACKUNG	PZS/CAJA TILES/BOX PIÈCES/BOITE	M²/CAJA SQM/BOX MÈTRES/BOITE	KG/CAJA KG/BOX KG/BOITE	CAJAS/PALLET BOXES/PALLET BOITES/PALETTE	M²/PALLET SQM/PALLET MÈTRES/PALETTE	KG/PALLET KG/PALLET MÈTRES/PALETTE
23X26	16	0.75	14.38	60	45.00	863
20X60	12	1.44	21.48	48	69.12	1031
20X20	25	1.00	19.00	60	60.00	1140

Para más información técnica, especificaciones e imágenes visite nuestra web y busque: Stay
El embalaje de los artículos está sujeto a variaciones, para obtener el dato exacto y actual se recomienda consultar la web.
For more technical information, specifications and images, visit our website and search: Stay
The packing of our items is subject to variations. To get the most accurate and updated information, we recommend to check the website.
Pour plus d'informations techniques, de spécifications et de visuels, visitez notre site web et recherchez : Stay
L'emballage des articles est sujet à variation, pour obtenir les données exactes et actuelles il est recommandé de consulter notre site web.



STAY WHITE 20X60 · STAY GREEN 20X60 · ISLA GREEN MIX 20X60 · ISLA GREEN MIX 20X20.



FUNNY BLANCO
20 X 60 / 8" X 24" N91/M



FUNNY TURQUESA
20 X 60 / 8" X 24" R14/M



DECOR SET(3) ADRIANA TURQUESA/PURPURA
20 X 60 / 8" X 24" K59/P



DECOR SET(2) IMPULSE TURQUESA
20 X 60 / 8" X 24" K60/P



DECOR CHICOTE I BLANCO
20 X 60 / 8" X 24" K60/P



DECOR CHICOTE II BLANCO
20 X 60 / 8" X 24" K60/P



FUNNY BEIGE
20 X 60 / 8" X 24" N91/M



FUNNY CHOCO
20 X 60 / 8" X 24" R14/M



FUNNY BURDEOS
20 X 60 / 8" X 24" R27/M



DECOR SET(2) IMPULSE BURDEOS
20 X 60 / 8" X 24" K60/P



DECOR CHICOTE I BEIGE
20 X 60 / 8" X 24" K60/P



DECOR CHICOTE II BEIGE
20 X 60 / 8" X 24" K60/P

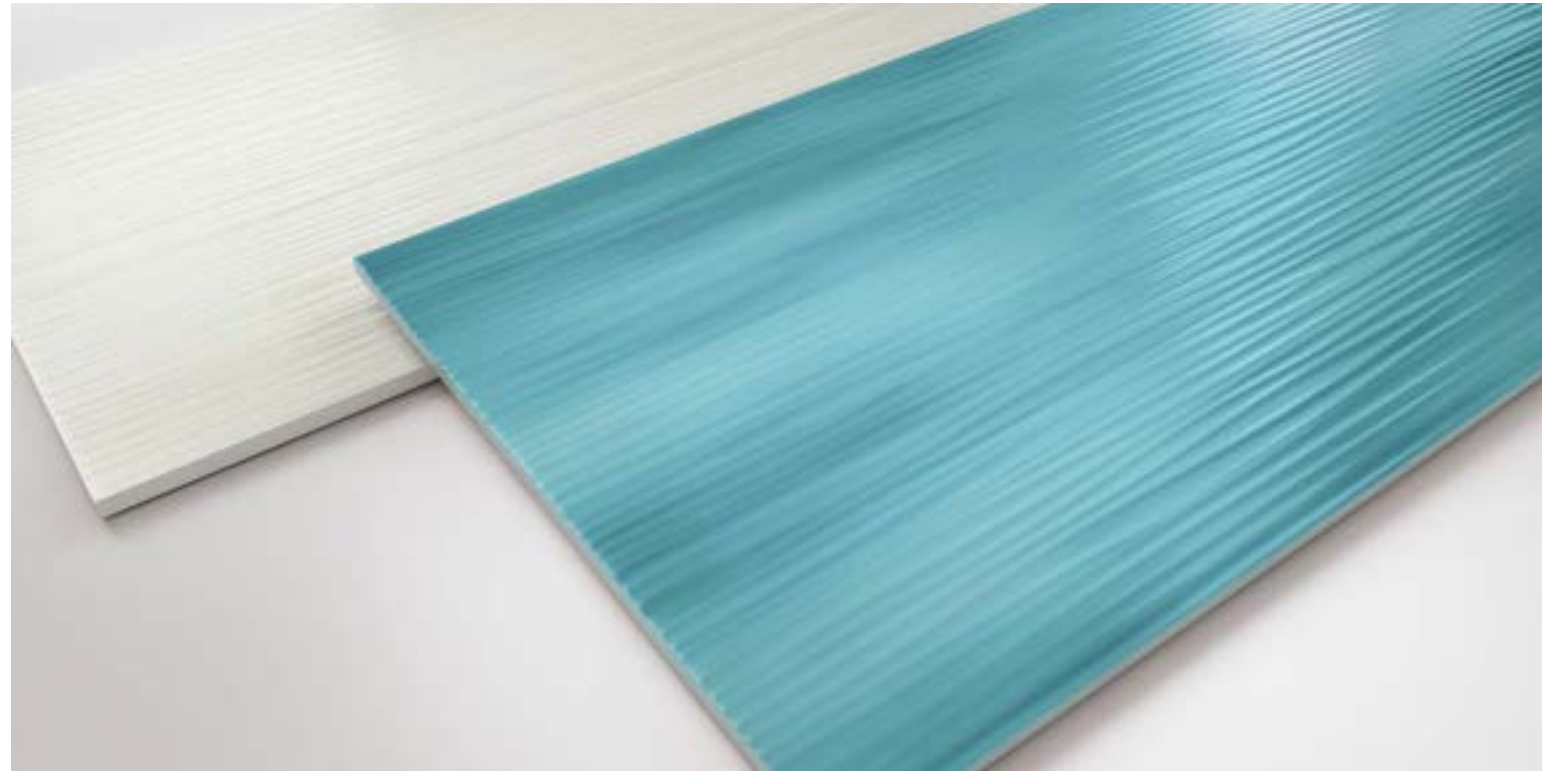

CARACTERÍSTICAS TÉCNICAS · TECHNICAL CHARACTERISTICS



PASTA ROJA / RED BODY
PÂTE ROUGE / ROTSCHERBIG



BRILLO / SHINE
BRILLANT / GLÄNZEN



REVESTIMIENTO / WALL TILE
FAÏENCE / WANDFLIESEN



VARIACION LEVE / SLIGHT VARIATION
LÉGERÉ VARIATION / LEICHT FARBSPIEL

FORMATO SIZE FORMAT VERPACKUNG	PZS/CAJA TILES/BOX PIÈCES/BOITE	M²/CAJA SQM/BOX MÈTRES/BOITE	KG/CAJA KG/BOX KG/BOITE	CAJAS/PALLET BOXES/PALLET BOITES/PALETTE	M²/PALLET SQM/PALLET MÈTRES/PALETTE	KG/PALLET KG/PALLET MÈTRES/PALETTE
20X60	9	1.08	17.91	64	69.12	1146

Para más información técnica, especificaciones e imágenes visite nuestra web y busque: Funny
El embalaje de los artículos está sujeto a variaciones, para obtener el dato exacto y actual se recomienda consultar la web.

For more technical information, specifications and images, visit our website and search: Funny
The packing of our items is subject to variations. To get the most accurate and updated information, we recommend to check the website.

Pour plus d'informations techniques, de spécifications et de visuels, visitez notre site web et recherchez : Funny
L'emballage des articles est sujet à variation, pour obtenir les données exactes et actuelles il est recommandé de consulter notre site web.

FUNNYTURQUESA 20X60. DECOR CHICOTE I & II BLANCO 20X60.





PR M HOME SNOW
20 X 60 / 8" X 24" J09/M



PR M HOME GREY
20 X 60 / 8" X 24" J09/M



PR M HOME SLATEGREY
20 X 60 / 8" X 24" J09/M



PR M HOME GRAPHITE
20 X 60 / 8" X 24" J09/M

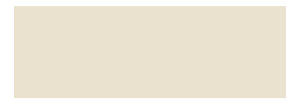

PR M HOME BEIGE
20 X 60 / 8" X 24" J09/M



PB *B DECOR MANY I
20 X 60 / 8" X 24" K60/P



PB *B DECOR MANY II
20 X 60 / 8" X 24" K60/P



PB *B DECOR MANY III
20 X 60 / 8" X 24" K60/P



PR M DECOR PRODIGY SNOW
20 X 60 / 8" X 24" K58/P



PR M DECOR PRODIGY GREY
20 X 60 / 8" X 24" K58/P



PR M DECOR PRODIGY SLATEGREY
20 X 60 / 8" X 24" K58/P



PR M DECOR PRODIGY GRAPHITE
20 X 60 / 8" X 24" K58/P



PR M DECOR PRODIGY BEIGE
20 X 60 / 8" X 24" K58/P



PR M DUNE SNOW
20 X 60 / 8" X 24" N90/M



PR M DECOR ARUBA GREY I
20 X 60 / 8" X 24" K60/P



PR M DECOR ARUBA GREY II
20 X 60 / 8" X 24" K60/P



PR M DECOR ARUBA BEIGE I
20 X 60 / 8" X 24" K60/P



PR M DECOR ARUBA BEIGE II
20 X 60 / 8" X 24" K60/P



P M RUS HEXAGON WHITE
175 X 20.2 / 7" X 8" J01/M



P M RUS HEXAGON GREY
175 X 20.2 / 7" X 8" J01/M



P M RUS HEXAGON SLATEGREY
175 X 20.2 / 7" X 8" J01/M



P M RUS HEXAGON GRAPHITE
175 X 20.2 / 7" X 8" J01/M

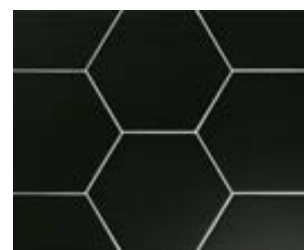

P M RUS HEXAGON BLACK
175 X 20.2 / 7" X 8" N57/M



THIS IS WHITE
20 X 50 / 8" X 20" N17/M



DECOR AMAZING WHITE
20 X 50 / 8" X 20" K12/P



THIS IS CREAM
20 X 50 / 8" X 20" N17/M



DECOR AMAZING CREAM
20 X 50 / 8" X 20" K12/P



THIS IS PEARL
20 X 50 / 8" X 20" N17/M



DECOR CIRCUS I WHITE
20 X 50 / 8" X 20" K12/P



THIS IS TORTOLA
20 X 50 / 8" X 20" N17/M



THIS IS BLUE
20 X 50 / 8" X 20" N17/M



DECOR CIRCUS II WHITE
20 X 50 / 8" X 20" K12/P



THIS IS COTO
20 X 50 / 8" X 20" N17/M



THIS IS GREY
20 X 50 / 8" X 20" N17/M



ANIKO WHITE MIX
20 X 50 / 8" X 20" N06/M



ANIKO CREAM MIX
20 X 50 / 8" X 20" N06/M



THIS IS WHITE 20X50. DECOR AMAZING WHITE 20X50.

CARACTERÍSTICAS TÉCNICAS · TECHNICAL CHARACTERISTICS

- V1** REVESTIMIENTO/WALL TILE FAÏENCE/WANDFLIESEN
- V1** ASPECTO UNIFORME/UNIFORM APPEARANCE APPARENCE UNIFORME/KEINE FARBSPIEL

FORMATO SIZE FORMAT VERPACKUNG	PZS/CAJA TILES/BOX PIÈCES/BOITE	M²/CAJA SQM/BOX MÈTRES/BOITE	KG/CAJA KG/BOX KG/BOITE	CAJAS/PALLET BOXES/PALLET BOITES/PALETTE	M²/PALLET SQM/PALLET MÈTRES/PALETTE	KG/PALLET KG/PALLET MÈTRES/PALETTE
20X60	9	1.08	18.95	80	86.40	1516
17,5X20,2	25	0.71	13.30	80	57.12	1064

Para más información técnica, especificaciones e imágenes visite nuestra web y busque: Home
El embalaje de los artículos está sujeto a variaciones, para obtener el dato exacto y actual se recomienda consultar la web.
For more technical information, specifications and images, visit our website and search: Home
The packing of our items is subject to variations. To get the most accurate and updated information, we recommend to check the website.
Pour plus d'informations techniques, de spécifications et de visuels, visitez notre site web et recherchez : Home
L'emballage des articles est sujet à variation, pour obtenir les données exactes et actuelles il est recommandé de consulter notre site web.

CARACTERÍSTICAS TÉCNICAS · TECHNICAL CHARACTERISTICS

- PR** PASTA ROJA/RED BODY PÂTE ROUGE/ROTSCHERBIG
- M** MATE/MATT MAT/MATT
- V1** REVESTIMIENTO/WALL TILE FAÏENCE/WANDFLIESEN
- V1** ASPECTO UNIFORME/UNIFORM APPEARANCE APPARENCE UNIFORME/KEINE FARBSPIEL

FORMATO SIZE FORMAT VERPACKUNG	PZS/CAJA TILES/BOX PIÈCES/BOITE	M²/CAJA SQM/BOX MÈTRES/BOITE	KG/CAJA KG/BOX KG/BOITE	CAJAS/PALLET BOXES/PALLET BOITES/PALETTE	M²/PALLET SQM/PALLET MÈTRES/PALETTE	KG/PALLET KG/PALLET MÈTRES/PALETTE
20X50	14	1.40	20.08	48	67.20	964

Para más información técnica, especificaciones e imágenes visite nuestra web y busque: This is
El embalaje de los artículos está sujeto a variaciones, para obtener el dato exacto y actual se recomienda consultar la web.
For more technical information, specifications and images, visit our website and search: This is
The packing of our items is subject to variations. To get the most accurate and updated information, we recommend to check the website.
Pour plus d'informations techniques, de spécifications et de visuels, visitez notre site web et recherchez : This is
L'emballage des articles est sujet à variation, pour obtenir les données exactes et actuelles il est recommandé de consulter notre site web.



BLANCO BRILLO 20 X 20 / 8" X 8" R86/M	SIR COBALTO 20 X 20 / 8" X 8" N19/M	KNIGHT BURDEOS 20 X 20 / 8" X 8" N19/M	KNIGHT VERDE BOTELLA 20 X 20 / 8" X 8" N19/M	SIR ALBINERO 20 X 20 / 8" X 8" N19/M
LONDON BLANCO 5 X 20 / 2" X 8" K34/P	AZUL COBALTO BRILLO 20 X 20 / 8" X 8" R95/M	BURDEOS BRILLO 20 X 20 / 8" X 8" R95/M	VERDE BOTELLA BRILLO 20 X 20 / 8" X 8" R95/M	NEGRO BRILLO 20 X 20 / 8" X 8" R95/M
TORELLO BLANCO 2 X 20 / 1" X 8" K45/P	LORD COBALTO 20 X 20 / 8" X 8" N99/M	LADY BURDEOS 20 X 20 / 8" X 8" N99/M	LADY VERDE BOTELLA 20 X 20 / 8" X 8" N99/M	LORD ALBINERO 20 X 20 / 8" X 8" N99/M
ZOCALO BLANCO 15 X 20 / 6" X 8" K26/P	LONDON COBALTO 5 X 20 / 2" X 8" K34/P	LONDON BURDEOS 5 X 20 / 2" X 8" K34/P	LONDON VERDE BOTELLA 5 X 20 / 2" X 8" K34/P	LONDON NEGRO 5 X 20 / 2" X 8" K34/P
ARENA BRILLO 20 X 20 / 8" X 8" R87/M	TORELLO COBALTO 2 X 20 / 1" X 8" K45/P	TORELLO BURDEOS 2 X 20 / 1" X 8" K45/P	TORELLO VERDE BOTELLA 2 X 20 / 1" X 8" K45/P	TORELLO NEGRO 2 X 20 / 1" X 8" K45/P
MARFIL BRILLO 20 X 20 / 8" X 8" R87/M	ZOCALO COBALTO 15 X 20 / 6" X 8" K26/P	ZOCALO BURDEOS 15 X 20 / 6" X 8" K26/P	ZOCALO VERDE BOTELLA 15 X 20 / 6" X 8" K26/P	ZOCALO NEGRO 15 X 20 / 6" X 8" K26/P
LONDON MARFIL 5 X 20 / 2" X 8" K34/P	MAJESTY COBALTO 20 X 20 / 8" X 8" K33/P	MAJESTY BURDEOS 20 X 20 / 8" X 8" K33/P	MAJESTY VERDE BOTELLA 20 X 20 / 8" X 8" K33/P	MAJESTY NEGRO 20 X 20 / 8" X 8" K33/P
TORELLO MARFIL 2 X 20 / 1" X 8" K45/P	MARINE MIX MARFIL 20 X 20 / 8" X 8" K33/P	MARINE MIX BLANCO 20 X 20 / 8" X 8" K33/P		
ZOCALO MARFIL 15 X 20 / 6" X 8" K26/P				

BLANCO BRILLO 20X20, SIR COBALTO 20X20, TORELLO COBALTO 2X20, LONDON COBALTO 5X20, ZOCALO COBALTO 15X20, KINGDOM COBALTO 20X20, MARINE MIX BLANCO 20X20



PAVIMENTO RECOMENDADO · RECOMMENDED FLOORING

KINGDOM BLANCO 20 X 20 / 8" X 8" N99/M	KINGDOM MARFIL 20 X 20 / 8" X 8" N99/M	KINGDOM COBALTO 20 X 20 / 8" X 8" R04/M
KINGDOM BURDEOS 20 X 20 / 8" X 8" R04/M	KINGDOM VERDE BOTELLA 20 X 20 / 8" X 8" R04/M	KINGDOM NEGRO 20 X 20 / 8" X 8" R04/M



DISPONIBLE EN TODOS LOS COLORES / AVAILABLE IN ALL COLORS

ANG.EXT.LONDON
3 X 5 / 1.2" X 2" K26/P

ANG.EXT.TORELLO
2 X 2 / 1" X 1" K26/P

CARACTERÍSTICAS TÉCNICAS · TECHNICAL CHARACTERISTICS

- | | |
|--|---|
| PASTA ROJA / RED BODY
PÂTE ROUGE / ROTSCHERBIG | BRILLO / SHINE
BRILLANT / GLÄNZEN |
| REVESTIMIENTO / WALL TILE
FAÏENCE / WANDFLIESEN | ASPECTO UNIFORME / UNIFORM APPEARANCE
APPARENCE UNIFORME / KEINE FARBSPIEL |

FORMATO SIZE FORMAT VERPACKUNG	PZS/CAJA TILES/BOX PIÈCES/BOITE	M²/CAJA SQM/BOX MÈTRES/BOITE	KG/CAJA KG/BOX KG/BOITE	CAJAS/PALLET BOXES/PALLET BOITES/PALETTE	M²/PALLET SQM/PALLET MÈTRES/PALETTE	KG/PALLET KG/PALLET MÈTRES/PALETTE
20X20	25	1.00	13.02	100	100.00	1302

Para más información técnica, especificaciones e imágenes visite nuestra web y busque: Lord
El embalaje de los artículos está sujeto a variaciones, para obtener el dato exacto y actual se recomienda consultar la web.
For more technical information, specifications and images, visit our website and search: Lord
The packing of our items is subject to variations. To get the most accurate and updated information, we recommend to check the website.
Pour plus d'informations techniques, de spécifications et de visuels, visitez notre site web et recherchez: Lord
L'emballage des articles est sujet à variation, pour obtenir les données exactes et actuelles il est recommandé de consulter notre site web.

Belvedere

 BELVEDERE WHITE 10 X 30 / 4" X 12" J02/M	 BELVEDERE WHISPER SAGE 10 X 30 / 4" X 12" J02/M	 BELVEDERE CEDAR 10 X 30 / 4" X 12" J02/M	 BELVEDERE TOURMALINE 10 X 30 / 4" X 12" J02/M	 BELVEDERE BLACK 10 X 30 / 4" X 12" R08/M
 TORELLO BELVEDERE WHITE 2 X 30 / 1" X 12" K25/P	 TORELLO BELVEDERE WHISPER SAGE 2 X 30 / 1" X 12" K25/P	 TORELLO BELVEDERE CEDAR 2 X 30 / 1" X 12" K25/P	 TORELLO BELVEDERE TOURMALINE 2 X 30 / 1" X 12" K25/P	 TORELLO BELVEDERE BLACK 2 X 30 / 1" X 12" K25/P
 MOLDURA BELVEDERE WHITE 5 X 30 / 2" X 12" K26/P	 MOLDURA BELVEDERE WHISPER SAGE 5 X 30 / 2" X 12" K26/P	 MOLDURA BELVEDERE CEDAR 5 X 30 / 2" X 12" K26/P	 MOLDURA BELVEDERE TOURMALINE 5 X 30 / 2" X 12" K26/P	 MOLDURA BELVEDERE BLACK 5 X 30 / 2" X 12" K26/P
 BELVEDERE CREAM 10 X 30 / 4" X 12" J02/M	 BELVEDERE LATTE 10 X 30 / 4" X 12" J02/M	 BELVEDERE AVOCADO 10 X 30 / 4" X 12" J02/M		
 TORELLO BELVEDERE CREAM 2 X 30 / 1" X 12" K25/P	 TORELLO BELVEDERE LATTE 2 X 30 / 1" X 12" K25/P	 TORELLO BELVEDERE AVOCADO 2 X 30 / 1" X 12" K25/P		
 MOLDURA BELVEDERE CREAM 5 X 30 / 2" X 12" K26/P	 MOLDURA BELVEDERE LATTE 5 X 30 / 2" X 12" K26/P	 MOLDURA BELVEDERE AVOCADO 5 X 30 / 2" X 12" K26/P		



BELVEDERE TOURMALINE 10X30/BELVEDERE CREAM 10X30/BELVEDERE BLACK 10X30

CARACTERÍSTICAS TÉCNICAS · TECHNICAL CHARACTERISTICS

PR PASTA ROJA / RED BODY PÂTE ROUGE / ROTSCHERBIG	B BRILLO / SHINE BRILLANT / GLÄNZEN
V1 REVESTIMIENTO / WALL TILE FAÏENCE / WANDFLIESEN	V1 ASPECTO UNIFORME / UNIFORM APPEARANCE APPARENCE UNIFORME / KEINE FARBSPIEL













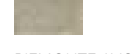

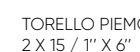



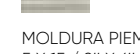

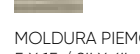



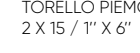

FORMATO SIZE FORMAT VERPACKUNG	PZS/CAJA TILES/BOX PIÈCES/BOITE	M²/CAJA SQM/BOX MÈTRES/BOITE	KG/CAJA KG/BOX KG/BOITE	CAJAS/PALLET BOXES/PALLET BOITES/PALETTE	M²/PALLET SQM/PALLET MÈTRES/PALETTE	KG/PALLET KG/PALLET MÈTRES/PALETTE
10X30	34	1.02	12.86	87	88.74	1119

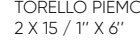
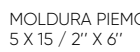
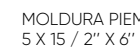
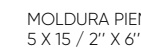
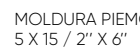
Para más información técnica, especificaciones e imágenes visite nuestra web y busque: Belvedere
El embalaje de los artículos está sujeto a variaciones, para obtener el dato exacto y actual se recomienda consultar la web.

For more technical information, specifications and images, visit our website and search: Belvedere
The packing of our items is subject to variations. To get the most accurate and updated information, we recommend to check the website.

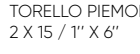
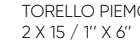
Pour plus d'informations techniques, de spécifications et de visuels, visitez notre site web et recherchez: Belvedere
L'emballage des articles est sujet à variation, pour obtenir les données exactes et actuelles il est recommandé de consulter notre site web.

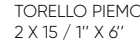
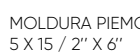
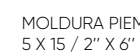
Piemonte

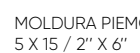
 PIEMONTE WHITE 7.5 X 15 / 3" X 6" R15/M	 PIEMONTE WHISPER SAGE 7.5 X 15 / 3" X 6" R68/M	 PIEMONTE CEDAR 7.5 X 15 / 3" X 6" R68/M	 PIEMONTE AVOCADO 7.5 X 15 / 3" X 6" R68/M
 TORELLO PIEMONTE WHITE 2 X 15 / 1" X 6" K45/P	 TORELLO PIEMONTE WHISPER SAGE 2 X 15 / 1" X 6" K45/P	 TORELLO PIEMONTE CEDAR 2 X 15 / 1" X 6" K45/P	 TORELLO PIEMONTE AVOCADO 2 X 15 / 1" X 6" K45/P
 MOLDURA PIEMONTE WHITE 5 X 15 / 2" X 6" K34/P	 MOLDURA PIEMONTE WHISPER SAGE 5 X 15 / 2" X 6" K34/P	 MOLDURA PIEMONTE CEDAR 5 X 15 / 2" X 6" K34/P	 MOLDURA PIEMONTE AVOCADO 5 X 15 / 2" X 6" K34/P
 PIEMONTE APPLE 7.5 X 15 / 3" X 6" R68/M	 PIEMONTE TOURMALINE 7.5 X 15 / 3" X 6" R28/M	 PIEMONTE GRAPHITE 7.5 X 15 / 3" X 6" R28/M	 PIEMONTE BLACK 7.5 X 15 / 3" X 6" R28/M
 TORELLO PIEMONTE APPLE 2 X 15 / 1" X 6" K45/P	 TORELLO PIEMONTE TOURMALINE 2 X 15 / 1" X 6" K45/P	 TORELLO PIEMONTE GRAPHITE 2 X 15 / 1" X 6" K45/P	 TORELLO PIEMONTE BLACK 2 X 15 / 1" X 6" K45/P
 MOLDURA PIEMONTE APPLE 5 X 15 / 2" X 6" K34/P	 MOLDURA PIEMONTE TOURMALINE 5 X 15 / 2" X 6" K34/P	 MOLDURA PIEMONTE GRAPHITE 5 X 15 / 2" X 6" K34/P	 MOLDURA PIEMONTE BLACK 5 X 15 / 2" X 6" K34/P
 PIEMONTE CREAM 7.5 X 15 / 3" X 6" R15/M	 PIEMONTE LATTE 7.5 X 15 / 3" X 6" R68/M	 PIEMONTE CHOCOLATE 7.5 X 15 / 3" X 6" R28/M	 PIEMONTE MAROON 7.5 X 15 / 3" X 6" R28/M
 TORELLO PIEMONTE CREAM 2 X 15 / 1" X 6" K45/P	 TORELLO PIEMONTE LATTE 2 X 15 / 1" X 6" K45/P	 TORELLO PIEMONTE CHOCOLATE 2 X 15 / 1" X 6" K45/P	 TORELLO PIEMONTE MAROON 2 X 15 / 1" X 6" K45/P
 MOLDURA PIEMONTE CREAM 5 X 15 / 2" X 6" K34/P	 MOLDURA PIEMONTE LATTE 5 X 15 / 2" X 6" K34/P	 MOLDURA PIEMONTE CHOCOLATE 5 X 15 / 2" X 6" K34/P	 MOLDURA PIEMONTE MAROON 5 X 15 / 2" X 6" K34/P



CARACTERÍSTICAS TÉCNICAS · TECHNICAL CHARACTERISTICS

PR PASTA ROJA / RED BODY PÂTE ROUGE / ROTSCHERBIG	B BRILLO / SHINE BRILLANT / GLÄNZEN
V1 REVESTIMIENTO / WALL TILE FAÏENCE / WANDFLIESEN	V1 ASPECTO UNIFORME / UNIFORM APPEARANCE APPARENCE UNIFORME / KEINE FARBSPIEL

FORMATO SIZE FORMAT VERPACKUNG	PZS/CAJA TILES/BOX PIÈCES/BOITE	M²/CAJA SQM/BOX MÈTRES/BOITE	KG/CAJA KG/BOX KG/BOITE	CAJAS/PALLET BOXES/PALLET BOITES/PALETTE	M²/PALLET SQM/PALLET MÈTRES/PALETTE	KG/PALLET KG/PALLET MÈTRES/PALETTE
7,5X15	44	0.50	6.29	85	42.50	535

Para más información técnica, especificaciones e imágenes visite nuestra web y busque: Piemonte
El embalaje de los artículos está sujeto a variaciones, para obtener el dato exacto y actual se recomienda consultar la web.

For more technical information, specifications and images, visit our website and search: Piemonte
The packing of our items is subject to variations. To get the most accurate and updated information, we recommend to check the website.

Pour plus d'informations techniques, de spécifications et de visuels, visitez notre site web et recherchez: Piemonte
L'emballage des articles est sujet à variation, pour obtenir les données exactes et actuelles il est recommandé de consulter notre site web.

Loft

WEB COLLECTION

LOFT BLANCO 10 X 30 / 4" X 12" P54/M	LOFT GRIS 10 X 30 / 4" X 12" J02/M	LOFT PLATA 10 X 30 / 4" X 12" J02/M	LOFT SAGE 10 X 30 / 4" X 12" J02/M	LOFT NEGRO 10 X 30 / 4" X 12" R08/M
LOFT CREMA 10 X 30 / 4" X 12" J02/M	LOFT MARFIL 10 X 30 / 4" X 12" J02/M	LOFT LATE 10 X 30 / 4" X 12" J02/M	LOFT ROSA 10 X 30 / 4" X 12" J02/M	LOFT CHOCO 10 X 30 / 4" X 12" R08/M
LOFT PISCINA 10 X 30 / 4" X 12" J02/M	LOFT TURQUESA 10 X 30 / 4" X 12" J02/M	LOFT LUNA 10 X 30 / 4" X 12" R08/M	LOFT PETROLEO 10 X 30 / 4" X 12" R08/M	LOFT COBALTO 10 X 30 / 4" X 12" R08/M
LOFT LAVANDA 10 X 30 / 4" X 12" J02/M	LOFT VIOLA 10 X 30 / 4" X 12" J02/M	LOFT PURPLE 10 X 30 / 4" X 12" R08/M	LOFT GRANATE 10 X 30 / 4" X 12" R08/M	LOFT FLAMINGO 10 X 30 / 4" X 12" J02/M
LOFT SOL 10 X 30 / 4" X 12" R08/M	LOFT NARANJA 10 X 30 / 4" X 12" R08/M	LOFT ROJO 10 X 30 / 4" X 12" R20/M	LOFT OASIS 10 X 30 / 4" X 12" R08/M	LOFT HIERBA 10 X 30 / 4" X 12" J02/M

CARACTERÍSTICAS TÉCNICAS · TECHNICAL CHARACTERISTICS

- PR** PASTA ROJA/RED BODY
PÂTE ROUGE/ROTSCHERBIG
- *B** BRILLO/SHINE
BRILLANT/GLÄNZEN
- V1** ASPECTO UNIFORME/UNIFORM APPEARANCE
APPARENCE UNIFORME/KEINE FARBSPIEL

FORMATO SIZE FORMAT VERPACKUNG	PZS/CAJA TILES/BOX PIÈCES/BOITE	M²/CAJA SQM/BOX MÈTRES/BOITE	KG/CAJA KG/BOX KG/BOITE	CAJAS/PALLET BOXES/PALLET BOITES/PALETTE	M²/PALLET SQM/PALLET MÈTRES/PALETTE	KG/PALLET KG/PALLET MÈTRES/PALETTE
10X30	34	1.02	14.25	87	88.74	1240

Para más información técnica, especificaciones e imágenes visite nuestra web y busque: Loft
El embalaje de los artículos está sujeto a variaciones, para obtener el dato exacto y actual se recomienda consultar la web.

For more technical information, specifications and images, visit our website and search: Loft
The packing of our items is subject to variations. To get the most accurate and updated information, we recommend to check the website.

Pour plus d'informations techniques, de spécifications et de visuels, visitez notre site web et recherchez : Loft
L'emballage des articles est sujet à variation, pour obtenir les données exactes et actuelles il est recommandé de consulter notre site web.

Metro

WEB COLLECTION

BISELADO BLANCO BR 10 X 20 / 4" X 8" N09/M	TORELLO BLANCO 2 X 20 / 1" X 8" K45/P	BISELADO MARFIL BRILLO 10 X 20 / 4" X 8" N98/M	TORELLO MARFIL 2 X 20 / 1" X 8" K45/P	BISELADO NEGRO BR 10 X 20 / 4" X 8" N98/M	TORELLO NEGRO 2 X 20 / 1" X 8" K45/P	BISELADO CREMA BR 10 X 20 / 4" X 8" N98/M
ZOCALO BLANCO 15 X 20 / 6" X 8" K26/P	LONDON BLANCO 5 X 20 / 2" X 8" K34/P	ZOCALO MARFIL 15 X 20 / 6" X 8" K26/P	LONDON MARFIL 5 X 20 / 2" X 8" K34/P	ZOCALO NEGRO 15 X 20 / 6" X 8" K26/P	LONDON NEGRO 5 X 20 / 2" X 8" K34/P	LONDON CREMA 5 X 20 / 2" X 8" K34/P
	BISELADO BLANCO BRILLO 7.5 X 15 / 3" X 6" P31/M			BISELADO NEGRO BRILLO 7.5 X 15 / 3" X 6" R13/M		BISELADO CREMA BRILLO 7.5 X 15 / 3" X 6" R15/M
						ZOCALO CREMA 15 X 20 / 6" X 8" K26/P

CARACTERÍSTICAS TÉCNICAS · TECHNICAL CHARACTERISTICS

- PR** PASTA ROJA/RED BODY
PÂTE ROUGE/ROTSCHERBIG
- *B** BRILLO/SHINE
BRILLANT/GLÄNZEN
- V1** ASPECTO UNIFORME/UNIFORM APPEARANCE
APPARENCE UNIFORME/KEINE FARBSPIEL

FORMATO SIZE FORMAT VERPACKUNG	PZS/CAJA TILES/BOX PIÈCES/BOITE	M²/CAJA SQM/BOX MÈTRES/BOITE	KG/CAJA KG/BOX KG/BOITE	CAJAS/PALLET BOXES/PALLET BOITES/PALETTE	M²/PALLET SQM/PALLET MÈTRES/PALETTE	KG/PALLET KG/PALLET MÈTRES/PALETTE
10X20	50	1.00	12.70	96	96.00	1219
7,5X15	60	0.68	8.81	125	85.23	1101

Para más información técnica, especificaciones e imágenes visite nuestra web y busque: Metro
El embalaje de los artículos está sujeto a variaciones, para obtener el dato exacto y actual se recomienda consultar la web.

For more technical information, specifications and images, visit our website and search: Metro
The packing of our items is subject to variations. To get the most accurate and updated information, we recommend to check the website.

Pour plus d'informations techniques, de spécifications et de visuels, visitez notre site web et recherchez : Metro
L'emballage des articles est sujet à variation, pour obtenir les données exactes et actuelles il est recommandé de consulter notre site web.

Colors

WEB COLLECTION

BLANCO BRILLO 20 X 20 / 8" X 8" R86/M	MARFIL BRILLO 20 X 20 / 8" X 8" R87/M	CREMA BRILLO 20 X 20 / 8" X 8" R87/M	ARENA BRILLO 20 X 20 / 8" X 8" R87/M	GRIS BRILLO 20 X 20 / 8" X 8" R87/M	ROSA BRILLO 20 X 20 / 8" X 8" R87/M
AMARILLO MICHELIN BRILLO 20 X 20 / 8" X 8" R95/M	SOL BRILLO 20 X 20 / 8" X 8" R95/M	PISTACHO BRILLO 20 X 20 / 8" X 8" R95/M	AZUL PISCINA BR 20 X 20 / 8" X 8" R87/M	AZUL MAR BRILLO 20 X 20 / 8" X 8" R87/M	AZUL COBALTO BRILLO 20 X 20 / 8" X 8" R95/M
NARANJA BRILLO 20 X 20 / 8" X 8" R95/M	ROJO BRILLO 20 X 20 / 8" X 8" N94/M	BURDEOS BRILLO 20 X 20 / 8" X 8" R95/M	MORADO BRILLO 20 X 20 / 8" X 8" R95/M	NEGRO BRILLO 20 X 20 / 8" X 8" R95/M	VERDE BOTELLA BRILLO 20 X 20 / 8" X 8" R95/M

WEB COLLECTION

BLANCO MATE 20 X 20 / 8" X 8" R86/M	MARFIL MATE 20 X 20 / 8" X 8" R87/M	CANELA MATE 20 X 20 / 8" X 8" R87/M	CAVA MATE 20 X 20 / 8" X 8" R87/M	ROSA MATE 20 X 20 / 8" X 8" R87/M	CORAL MATE 20 X 20 / 8" X 8" R87/M
GRIS MATE 20 X 20 / 8" X 8" R87/M	GRIS PLATA MATE 20 X 20 / 8" X 8" R87/M	GRIS MARENGO MATE 20 X 20 / 8" X 8" R90/M	MANGO MATE 20 X 20 / 8" X 8" R87/M	NARANJA MATE 20 X 20 / 8" X 8" R95/M	ROJO MATE 20 X 20 / 8" X 8" N94/M
AZUL CELESTE MATE 20 X 20 / 8" X 8" R87/M	AZUL MAR MATE 20 X 20 / 8" X 8" R87/M	AZUL ZAFIRO MATE 20 X 20 / 8" X 8" R90/M	AZUL COBALTO MATE 20 X 20 / 8" X 8" R95/M	CAFE MATE 20 X 20 / 8" X 8" R95/M	NEGRO MATE 20 X 20 / 8" X 8" R95/M

CARACTERÍSTICAS TÉCNICAS · TECHNICAL CHARACTERISTICS

- PR** PASTA ROJA/RED BODY
PÂTE ROUGE/ROTSCHERBIG
- V1** ASPECTO UNIFORME/UNIFORM APPEARANCE
APPARENCE UNIFORME/KEINE FARBSPIEL

FORMATO SIZE FORMAT VERPACKUNG	PZS/CAJA TILES/BOX PIÈCES/BOITE	M²/CAJA SQM/BOX MÈTRES/BOITE	KG/CAJA KG/BOX KG/BOITE	CAJAS/PALLET BOXES/PALLET BOITES/PALETTE	M²/PALLET SQM/PALLET MÈTRES/PALETTE	KG/PALLET KG/PALLET MÈTRES/PALETTE
20X20	25	1.00	13.02	100	100.00	1302

Para más información técnica, especificaciones e imágenes visite nuestra web y busque: Colors
El embalaje de los artículos está sujeto a variaciones, para obtener el dato exacto y actual se recomienda consultar la web.

For more technical information, specifications and images, visit our website and search: Colors
The packing of our items is subject to variations. To get the most accurate and updated information, we recommend to check the website.

Pour plus d'informations techniques, de spécifications et de visuels, visitez notre site web et recherchez : Colors
L'emballage des articles est sujet à variation, pour obtenir les données exactes et actuelles il est recommandé de consulter notre site web.



INDICATIONS DE NETTOYAGE ET DE ENTRETIEN

NETTOYAGE DE FIN DE CHANTIER

APRÈS LA POSE EST IMPORTANT NETTOYER CORRECTEMENT POUR ELIMINER LES RÉSIDUES DES JOINTS ET EN GENERAL LA SALETÉ DE APRÈS CHANTIER POUR BIEN EFFECTUER CETTE OPERATION NOUS CONSEILLONS L'UTILISATION D' UN DETERGENT LEGEREMENT ACIDE QUI N'EXHALE PAS DES FUMÉES TOXIQUES ET QUI RESPECTE LES JOINTS, LE MATÉRIEL COMME LE DETER-DEK.

ENTRETIEN ORDINAIRE:

POUR UN ENTRETIEN DU SOL NOUS VOUS CONSEILLONS L'UTILISATION DE UN DETERGENT NEUTRE AVEC UN POUVOIR DE NETTOYAGE ÉLEVÉ COMME LE FILACLEANER

ENTRETIEN EXTRAORDINAIRE:

TYPE DE SALETÉ	PRODUIT À UTILISER
CIMENT, CALCAIRE DE L'EAU, OXIDES, SALETÉ METALLIQUE	DETERDEK
RÉSIDUS, TACHES ET AURÉOLES DE MORTIER DE JOINTOIEMENT ÉPOXY	FILA CR10
GRAISSE, BOISSONS, NOURRITURE, CHEWINGUM, STYLO,TEINTURES	FILA PS/87
VERNIS POUR LE GRAFFITIS	FILA NOPAINT STAR
CIRES DE CHANDELLE, RÉSINE DES ARBRES, RÉSIDUES DE SCOTCH	FILASOLV

CLEANING AND MAINTENANCE:

CLEANING AFTER LAYING:

WE SUGGEST A GOOD INITIAL CLEANING AFTER THE LAYING ON THE FLOOR OR WALL, THIS IS VERY IMPORTANT FOR REMOVING RESIDUAL GROUTING AND THE NORMAL DIRT COMING FROM THE BUILDING WORKS. WE SUGGEST THE USE OF OUR PRODUCT FILA DETERDEK, THAT IS A LIGHTLY ACID PRODUCT THAT DOESN'T EMIT FUMES THAT ARE HARMFUL FOR THE USER AND THAT CAN ATTACKS JOINTS.

REGULAR MAINTENANCE:

FOR A GOOD CLEANING OF THE FLOOR WE SUGGEST THE USE OF OUR PRODUCT FILA CLEANER IT'S A NATURAL DETERGENT WITH A HIGH CLEANING POWER.

EXTRAORDINARY CLEANING:

TYPE OF DIRTY	DAS RICHTIGE PRODUCT
ZEMENT, KALKSTEIN, METAL TRACER, RUST	DETERDEK
RESIDUALS, STAINS AND HALOS OF EPOXI JOINTS	FILA CR10
GREASY, DRINKS, FOOD, TIRE MARKS, COLOURS, MARKER, ETC.	FILA PS/87
GRAFITIS	FILA NOPAINT STAR
WAX CANDEL, BITUMEN, ADHESIVE TAPE RESIDUES.	FILASOLV

REINIGUNG UND PFLEGE:

ERSTREINIGUNG:

WIR EMPFEHLEN EINE ERSTREINIGUNG NACH DER FLIESENVERLEGUNG, DIE SEHR WICHTIG UM ZEMENTRÜCKSTÄNDE, KLEBER UND SCHMUTZ VERSCHIEDER ART ZU ENTFERNEN IST. WIR EMPFEHLEN UNSERES PRODUKT FILA DETERDEK, EIN LEICHT SÄURIGEHALTES PRODUKT, DAS KEINE SCHÄDLICHE DÄMPFE FÜR DEN ANWENDER UND DIE UMWELT GIBT UND WIRKUNGSVOLL AUF MÖRTEL IST.

UNTERHALTSPFLEGE:

FÜR EINE NORMALE FLÄCHENREINIGUNG, EMPFEHLEN WIR UNSERES PRODUKT FILA CLEANER, DAS UNIVERSALREINIGER.

AUSSERORDENTLICHE REINIGUNG:

ART VON SCHMUTZ	DAS RICHTIGE PRODUKT
ZEMENT, KALKSTEIN, METALLSPÜREN, ROST	DETERDEK
RÜCKSTANDE, FLECKEN UND RÄNDERN VON EPOXIDMÖRTEL	FILA CR10
FETT, GETRÄNKE, ESSEN, REIFENSPÜREN, FARBEN, ETC.	FILA PS/87
GRAFFITI	FILA NOPAINT STAR
WACHSE, BITUMEN, KLEBER.	FILASOLV

ЧИСТКА И ОБСЛУЖИВАНИЕ:

ЧИСТКА ПОСЛЕ РЕМОНТНЫХ РАБОТ;
 МЫ ПРЕДЛАГАЕМ ХОРОШУЮ НАЧАЛЬНУЮ ЧИСТКУ ПОСЛЕ РЕМОНТНЫХ РАБОТ НА ПОЛУ ИЛИ СТЕНАХ, ТАК КАК ЭТО НЕОБХОДИМО ДЛЯ УДАЛЕНИЯ ОСТАТКОВ ГРУНТА И ОБЫЧНОЙ ГРЯЗИ, ВОЗНИКАЮЩЕЙ В РЕЗУЛЬТАТЕ СТРОИТЕЛЬНЫХ РАБОТ.
 МЫ ПРЕДЛАГАЕМ ВОСПОЛЬЗОВАТЬСЯ НАШИМ ПРОДУКТОМ FILLA DETERDEK, КОТОРЫЙ НЕ СОДЕРЖИТ БОЛЬШОГО КОЛИЧЕСТВА КИСЛОТЫ, ОПАСНОЙ ДЛЯ ЗДОРОВЬЯ.
 РЕГУЛЯРНОЕ ОБСЛУЖИВАНИЕ:
 ДЛЯ ХОРОШЕЙ ЧИСТКИ ПОЛА МЫ ПРЕДЛАГАЕМ НАШ ПРОДУКТ FILLA CLEANER- ЭТО НАТУРАЛЬНОЕ МОЮЩЕЕ СРЕДСТВО, С ВЫСОКОЙ МОЮЩЕЙ СПОСОБНОСТЬЮ. ДЛЯ ЭКСТРЕННОЙ ЧИСТКИ:

ВИД ЗАГРЯЗНЕНИЯ	ПРОДУКТ ИСПОЛЬЗОВАНИЯ
ЦЕМЕНТ, НАЛЕТ, РЖАВЧИНА	DETERDEK
ОСТАТКИ И ПЯТНА ЭПОКСИДНОЙ СМОЛЫ	FILLA CR10
ЖИР, ПЯТНА ОТ НАПИТКОВ И ЕДЫ, КРАСКА, СЛЕДЫ ОТ МАРКЕРОВ	FILLA PS/87
ГРАФИТИ	FILLA NOPAINT STAR
ВОСК, БИТУМ, ОСТАТКИ ИЗОЛЯЦИОННОЙ ЛЕНТЫ	FILASOLV

التنظيف والصيانة:

التنظيف بعد تركيب بلاط الأرضيات

بعد تركيب بلاط الأرضيات أو الجدران يوصى بغسله لإزالة الحشو المتبقي والأوساخ الناتجة عن الأشغال. ولهذه الغاية، فمن المستحسن استخدام منتج DETERDEK ، القليل الحموضة ولا تتبعث منه أبخرة ضارة بمركب البلاط أو أية أبخرة قد تؤدي إلى تلف اللحامات.

الصيانة

لتنظيف جيد لبلاط الأرضيات، نقترح استخدام منتج FILECLEANER ، وهو عبارة منظف محايد عالي الفعالية.

غسل استثنائي

خامسوالنا عون	بسانملا جتنملا
أصلملا و ريچملا و تنمسملا	DETERDEK
يمركوبيمالا نوج عملا تالما هو عقبدو قيسرتمملا اياقمبلا	FILLA CR10
تتاراطالما نع ؤمتمنالملا تامالم عملا ؤيئاذ عملا داوملما و تالمورشملا و نموملما عملا ،المقالما و	FILLA PS/87
ناردچملا ىلع تالمومرملما	FILLA NOPAINT STAR
قوصالملا قطرشالملا اياقمب ،راقلملا ،عمململا	FILASOLV



RECOMMENDED PRODUCT / PRODUCTO RECOMENDADO / PRODUIT RECOMMANDÉ	TYPE OF DIRT / TIPO DE SUCIEDAD / TYPE DE SALETÉ		
CEMENT REMOVER	CEMENT-BASED GROUT	RESIDUOS JUNTA CEMENTOSA	MORTIER CIMENT
	CONCRETE, PLASTER, WALL PAINT	CEMENTO, YESO, PINTURA PARA PARED	CIMENT, PLÂTRE, PEINTURE MURALE
	COAL, RUST, SALT EFFLORESCENCES	CARBÓN, ÓXIDO, EFLORESCENCIAS SALINAS	CHARBON, ROUILLE, SELS EFFLORESCENCES
EPOXY CLEANER	EPOXY GROUT	JUNTA EPOXÍDICA	MORTIER ÉPOXY
	BLACK SUCTION-CUP MARKS	MARCAS NEGRAS DE VENTOSA EN SUPERFICIES MATE	MARQUES NOIRES DE VENTOUSE
FLOOR CLEANER	DAILY ORDINARY CLEANING	LIMPIEZA DIARIA ORDINARIA	NETTOYAGE QUOTIDIEN NORMAL
TILE CLEANER	SUPERFICIAL PATINA, HEAVY DUTY CLEANING	PÁTINA SUPERFICIAL, LIMPIEZA PROFUNDA	PATINE SUPERFICIELLE, NETTOYAGE À FOND
	METAL MARKS, SIGNS AND RESIDUES	MARCAS Y RESIDUOS METÁLICOS	MARQUES DE MÉTAL, AURÉOLES ET RÉSIDUS
	STUBBORN DIRT, LIMESCALE BUILD-UPS, FOOTPRINT	SUCIEDAD OBSTINADA, ACUMULACIÓN DE CAL, HUELLAS	SALETÉ OBSTINÉE, ACCUMULATION DE CALCAIRE, EMPREINTES
COLOURED STAIN REMOVER	COFFE, WINE, DRINKS	CAFÉ, VINO, BEBIDAS	CAFÉ, VIN, BOISSONS, GLACES
	MARKER PEN, PERMANENT INK, HAIR DYE	RÓTULADOR, TINTA PERMANENTE, TINTE PARA EL CABELLO	MARQUEURS, ENCRE PERMANENT, TEINTURE DES CHEVEUX
DEEP DEGREASER	OIL, GREASE, BITUMINOUS RESIDUES	ACEITES, GRASAS, RESIDUOS BITUMINOSOS	HUILE, GRAS, RÉSIDUS BITUMINEUX
	WAX, RUBBER MARKS, TYRE MARKS	CERAS, MARCAS DE CAUCHO, MARCAS DE NEUMÁTICO	CIRE, MARQUES DE CAOUTCHOUC, MARQUES DE PNEUS
	SILICONE	SILICONA	SILICONE
	GREASY STAINS AND RESIDUES	RESIDUOS Y MANCHAS DE GRASA	TACHES DE GRAS ALIMENTAIRE ET RÉSIDUS
ALKALINE CLEANER	WATER-REPELLENT SUCTION-CUP MARKS	MARCAS DE VENTOSAS	MARQUES HYDROFUGES DE VENTOUSE
HONING CREAM	BACK-MARKS FROM MATT SURFACES	MARCA DE COSTILLA EN SUPERFICIES NO PULIDAS	MARQUES AU VERSO DUES À SURFACE MATTE
POLISHING CREAM	BACK-MARKS FROM POLISHED SURFACE	MARCA DE COSTILLA EN SUPERFICIES PULIDAS	MARQUES AU VERSO DUES À SURFACE POLIE
SHINE REPAIR LIGHT	SCRATCHES FROM LIGHT COLOURED POLISHED SURFACE	MARCAS Y ARAÑAZOS EN SUPERFICIES PULIDAS – COLORES CLAROS	RAYURES SUR SURFACE POLIE, COULEURS CLAIRES
SHINE REPAIR DARK	SCRATCHES FROM DARK COLOURED POLISHED SURFACE	MARCAS Y ARAÑAZOS EN SUPERFICIES PULIDAS – COLORES OSCUROS	RAYURES SUR SURFACE POLIE, COULEURS FONCÉES

EMPFOHLENES PRODUKT / PRODOTTO SUGGERITO / РЕКОМЕНДУЕМЫЙ ПРОДУКТ /	ART VON SCHMUTZ / TIPO DI SPORCO / ВИД ЗАГРЯЗНЕНИЯ	
CEMENT REMOVER	ZEMENTMÖRTEL	STUCCO CEMENTIZIO / ЦЕМЕНТНАЯ ЗАТІРКА
	BETON, GIPS, WANDFARBE	CEMENTO, INTONACO, PITTURA MURALE / ЦЕМЕНТ, ШТУКАТУРКА, НАСТЕННАЯ КРАСКА
	KOHLE, ROST, SALZAUSBLÜHUNGEN	CARBONE, RUGGINE, EFFLORESCENZE SALINE / УГОЛЬ, РЖАВЧИНА, ВЫСОЛЫ
EPOXY CLEANER	EPOXIDMÖRTEL	STUCCO EPOSSIDICO / ЭПОКСИДНАЯ ЗАТІРКА
	SCHWARZE SAUGNAPFSPUREN	RESIDUI DI VENTOSA NERI / ЧЕРНЫЕ СЛЕДЫ ПРИСОСОК
FLOOR CLEANER	TÄGLICHE REINIGUNG	PULIZIA QUOTIDIANA / ПОВСЕДНЕВНАЯ УБОРКА
TILE CLEANER	ÖBERFLÄCHLICHE PATINA, TIEFENREINIGUNG	PATINA SUPERFICIALE, PULIZIA DI PROFONDITÀ / ПОВЕРХНОСТНАЯ ПАТИНА, ЧИСТКА УСТОЙЧИВОГО ЗАГРЯЗНЕНИЯ
	METALLSPUREN, ZEICHEN UND RÜCKSTÄNDE	SEGNI E RESIDUI METALLICI / МЕТАЛЛИЧЕСКИЕ СЛЕДЫ И ОСТАТКИ
	HARTNÄCKIGER SCHMUTZ, KALKSTEIN, FUSSABDRUCK	SPORCO INTENSO, CALCARE, IMPRONTE / УСТОЙЧИВОЕ ЗАГРЯЗНЕНИЕ, НАКИПЬ, ОТПЕЧАТКИ
COLOURED STAIN REMOVER	KAFFEE, WEIN, GETRÄNKE	CAFFE, VINO, BEVANDE, INCHIOSTRI / КОФЕ, ВИНО, НАПИТКИ, ЧЕРНИЛА
	MARKER, TINTE, HAARFÄRBMITTEL	PENNARELLI INDELEBILI, TINTA PER CAPELLI / ПЕРМАНЕНТНЫЙ МАРКЕР, КРАСКА ДЛЯ ВОЛОС
DEEP DEGREASER	ÖL, FETT, BITUMINÖSE RÜCKSTÄNDE	OLIO, GRASSO, RESIDUI BITUMINOSI / МАСЛЯНЫЕ И ЖИРОВЫЕ ЗАГРЯЗНЕНИЯ, БИТУМНЫЕ ОСТАТКИ
	WACHS, GUMMIRÜCKSTÄNDE, REIFENSUREN	CERA, SEGNI DI GOMMA, SEGNI DI PNEUMATICI / ВОСК, СЛЕДЫ ОТ РЕЗИНЫ, СЛЕДЫ ОТ ШИН
	SILIKON	SILICONE / СИЛИКОН
	FETTFLECKEN UND RÜCKSTÄNDE	MACCHIE E RESIDUI DI CIBO GRASSI / ЖИРНЫЕ ПИЩЕВЫЕ ПЯТНА И ОСТАТКИ
ALKALINE CLEANER	WASSERABWEISENDE SAUGNAPFSPUREN	RESIDUI DI VENTOSA IDROREPELLENTI / ГИДРОФОБНЫЕ ОСТАТКИ ПРИСОСОК
HONING CREAM	RÜCKSPUREN AUF MATTEN OBERFLÄCHEN	ENGOBBIO SU SUPERFICI OPACHE / АНГОБ НА МАТОВЫХ ПОВЕРХНОСТЯХ
POLISHING CREAM	RÜCKSPUREN AUF POLIERTER OBERFLÄCHE	ENGOBBIO SU SUPERFICI LUCIDE / АНГОБ НА БЛЕСТЯЩИХ ПОВЕРХНОСТЯХ
SHINE REPAIR LIGHT	KRATZER AUF EINER POLIERTEN HELLEN OBERFLÄCHE	GRAFFI SU SUPERFICI LUCIDE CHIARE / ЦАРАПИНЫ НА ПОЛИРОВАННОЙ СВЕТОЙ ПОВЕРХНОСТИ
SHINE REPAIR DARK	KRATZER AUF EINER POLIERTEN, DUNKLEN OBERFLÄCHE	GRAFFI SU SUPERFICI LUCIDE SCURE / ЦАРАПИНЫ НА ПОЛИРОВАННОЙ ТЕМНОЙ ПОВЕРХНОСТИ

خاستملا عوڤ	حرت قملما جوتن قملما
يتمملا صرچا	تتمملا ليزم
حرجلما تارولبو اصلما، محظا نارديچا علاطو صرچا، تاسرخا	
يسكويولا صرچا	يسكويولا فظنم
طقشا باوكلا ءادوس تاملاء	
يداعلما يمويا فيظننلا	ضرلا فظنم
قائشا فيظننلا ، يحظسلا راجنرلا	طلايلا فظنم
تمنعم اياقبو تامال ع	
تمسكلا تامبرنلا مكاره ، كديعلا خامولا	
ميرك سولاو تابور شما رمخا، تعوقلا	ءغبحسلا ليزم
رحمه ءغصه ، مئادلا ربحل ، جلقلا قمال ع	قنولجلا
روص تاملاء ، طاطلما تاملاء ، عمشه	قديعلا فظنملا
تمنيمونيد تاملخم ، جوحش ، توير	
نوكلبيد	
اهاياقبو تمنهدلا باعظلا معيق	
ءاملا ءموقما طفقشا	نيل اللأ فظنم
"تام" جوطه نم ءيفل خلا تامال ع	ريشقلا ميرك
لوقصملا محظسلا نم ءيفل خلا تامال ع	معملتا ميرك
نوللا تحتة شووخ	عمللما حالصرا
قءاء نول نم شووخ	ءيخسولجا
	ملظملا عمللما حالصرا

La reproducción de los colores es aproximada. Se reserva el derecho de alterar o modificar los productos aquí relacionados.

The reproduction of the colours is approximate. Reserves the right to alter or amend the products here stated.

**Los códigos de precios y referencias deben verificarse ya que puede haber errores tipográficos.
Es recomendable consultar la web ya que cualquier producto de ese catálogo puede sufrir cambios en códigos de venta, formatos, packing..**

*Price codes and product codes should be checked, since there may be typographical errors.
We always recommend consulting the website as the products could undergo price code, format or packing changes.*

En la web también pueden consultar las características técnicas, consejos de colocación , elementos de merchandising o los diversos ambientes de cada una de las colecciones.

On the website you can also find the technical specifications, installation suggestions, merchandising elements and a variety of room scene pictures for each of the collections.



APE
best *for* you

apegrupo.com