

# AIR PURIFIER DEMI USER MANUAL

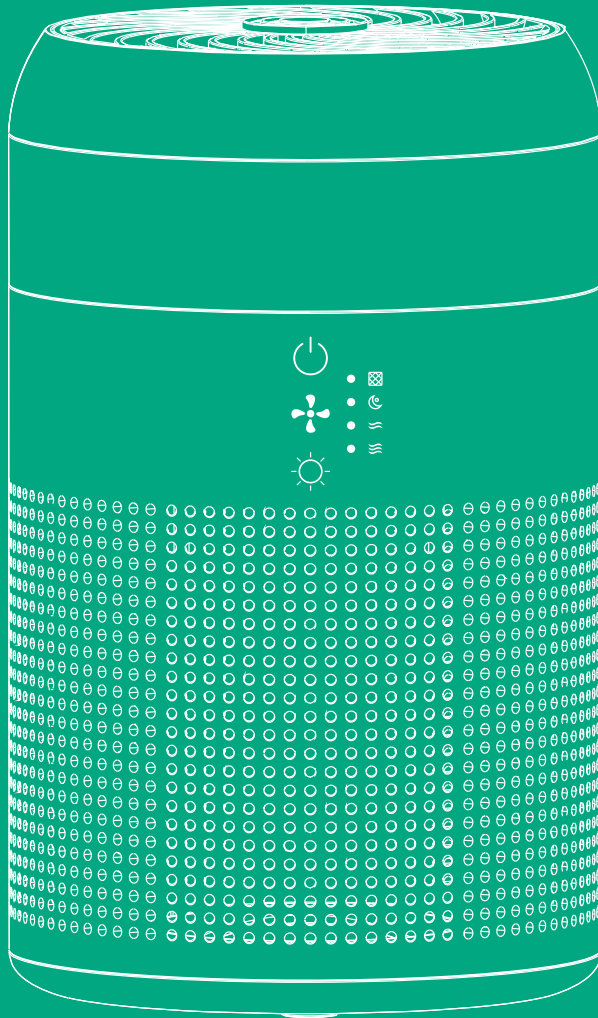

**floia**®

[service@afloia.com](mailto:service@afloia.com)

Thank you very much for using our products.

Please read the user manual carefully before use, and keep it for future reference.

# STOP

## PLEASE DO NOT RETURN THIS PRODUCT TO RETAILER

If you are missing parts, have ANY  
issues when operating this product,  
need replacement parts or need  
assistance please contact:

✉ Email : [service@afloia.com](mailto:service@afloia.com)



Facebook messenger



24/7 LIVE CHAT SUPPORT

Dear customers,

Thank you for purchasing Afloia Air Purifier.

Please keep this User Manual for your reference.  
This manual will guide you if you have any questions or troubleshooting problems.

---

## Top Features of Afloia Air Purifier

---

- **7 Color Led Light**  
The light is uniquely designed with 7 colors. You can set a color from blue/cyan/green/yellow/orange/red/purple as you like, or turn off the lights with one click.
- **Table Air Purifier**  
Portable air purifier with small size, specially adapted to purification of small space, such as desks in office or bedroom.
- **Designed with Aromatherapy**  
You can add your favorite essential oils to the aromatherapy box for soothing and pleasant experience.
- **Air Purification**  
The air purifier has a 3-stage filtration system (prefilter, carbon filter and HEPA filter), efficiently filtering smoke, pollen, dander, hair, smell and so on.
- **Adjustable Fan Speed**  
You may choose among 3 levels of fan speed. The fan at the Sleep Mode will run quietly, silently cleaning the room air during your sleep.

Please read the instructions carefully before using the product and keep them properly.

---

# CONTENTS

---

Before Use ● Top Features of Afloia Air Purifier	2
Description of Parts	4
During Use ● Names and Functions of Control Panel	5
About the Filter	6
How to Replace Filter	7-8
Aromatherapy Box Use Steps	9
Caution / Attention	10
Before Asking for Support ● Troubleshooting	11-12
Service Information ● Product Specifications and Inquiry about Malfunction	13

## Description of Parts

### Unboxing

1. Open the box, take out the foam lining, internal accessories and user manual.
2. Pull the air purifier out of the box, remove plastic covering around it, and clear its inner packaging material. Keep the box at a safe location for future use.
3. Open the base cover, take out the filter and charger, remove plastic bag around the filter.

### Description of Parts

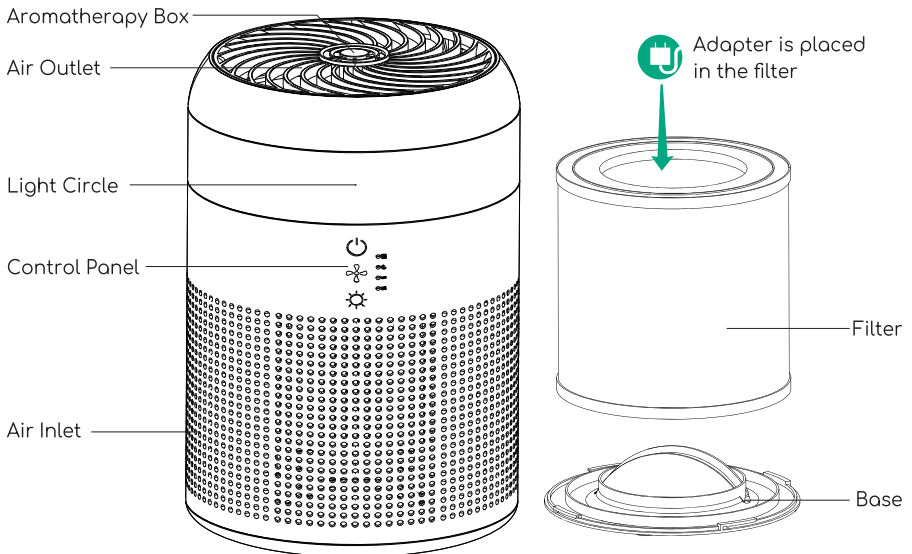

### Accessories



User Manual

※ The picture may differ from the actual product.

## Names and Functions of Control Panel

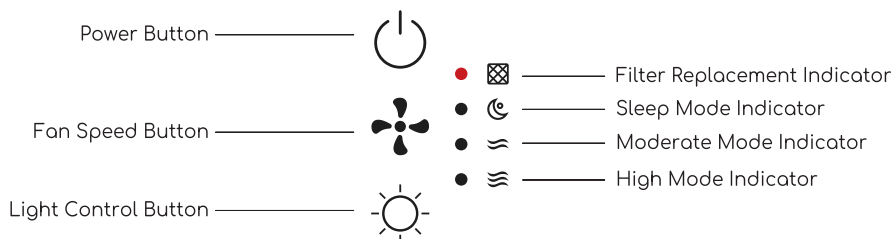



### \* Note

When the air purifier connects to the power outlet, it will beep for once, the lamp will turn on for 1 second and then turn off, this means that the air purifier is powered on.

When the light keeps flashing red, please press the power button for 7 seconds until the red light disappears.

## Button Description

	<p><b>Power Button</b></p> <p>1.Touch the power button for once to turn on the air purifier. The light will be turned on, and the default fan speed will be Moderate.</p> <p>2.Touch the power button again to turn off the air purifier.</p> <p>(Note: Without unplugging the power plug, turn off the air purifier and turn it on again, the fan speed defaults to the working state before shutting down.)</p>
	<p><b>Fan Speed Button</b></p> <p>Select mode: High--Mid--Low/Sleep. The corresponding indicator will be on.</p>
	<p><b>Light Control Button</b></p> <p>Turns on, off, or flashing mode</p> <p>At L mode (sleep mode), the light will be automatically turned off. Click the light button, the light will be turned on again.</p>

## Connect the Power

Please confirm that the input voltage is 100-240V 50/60Hz, and ensure that the power plug and your hands are dry before you insert the power cord plug into the outlet.

Note: Contact Customer Service when the power cord or plug is damaged or the power outlet is loose.

We strongly recommend that the damaged parts be repaired or replaced.

To replace the damaged power cord or plug, please visit Afloia website and contact Customer Service.

## About the Filter

### Air Purification

---

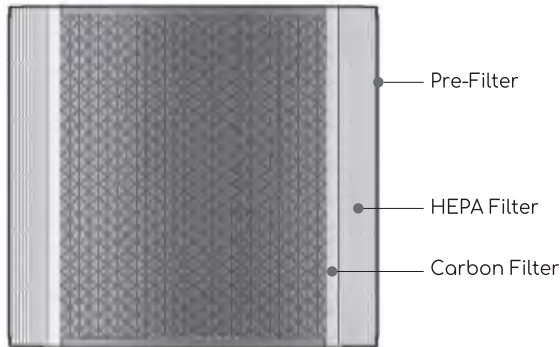

※ The picture may differ from the actual product.

True HEPA 3-Stage Filter	
Stage 1	Pre Filter
Stage 2	HEPA Filter
Stage 3	Carbon Filter

### Filter Replacement Cycle

---

We recommend replacing the filter every 3-6 months. However, you may need to change your filters sooner or later depending on use frequency and air quality.

For buying more filters, please visit Afloia website and contact Afloia customer service.

### Maintenance

- Ensure the product is unplugged before maintenance.
- Do not immerse the air purifier into water or any liquid.
- Do not use abrasive, corrosive or flammable cleansers (such as bleach or alcohol) to clean any part of the unit.
- Do not wash the filter.
- Do not use a vacuum cleaner to clean the filter.

### Cleaning and Storage

- Ensure the air purifier is powered-off and unplugged.
- Use a soft cloth with neutral cleanser to clean away any dust or debris from the surface of the air purifier and air intake/vent.
- If you do not use it for a long time, please turn on the air purifier for a few minutes from time to time to ensure a good performance.
- Please do not drop any water into the air purifier when cleaning the air outlet.

## How to Replace Filter

\* Note :

- Please remove the packaging from the filter before using it.
- Ensure the air purifier is unplugged before removing or installing the filter.
- Please wipe the dust on the filter regularly, do not wash or use it repeatedly.
- Please do not use other filters that are not designed for this air purifier.

- 1 When the filter replacement light stays red, it means the filter needs to be changed.

The light stays red if it is used for the first time.  
Operation method: restart the machine→press the power button for 7 seconds→until the red light disappears→is OK.

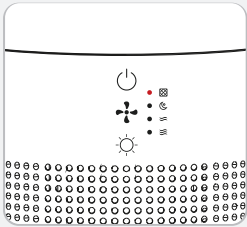

- 2 Invert the machine, and rotate the base along the direction marked "OPEN".

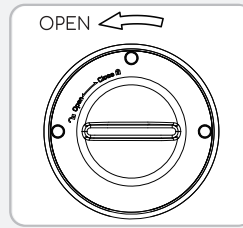

- 3 Take out the old filter from the air purifier.

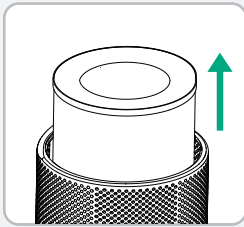

- 4 Remove the packaging around the new filter.



- 5 Install the filter into the machine.

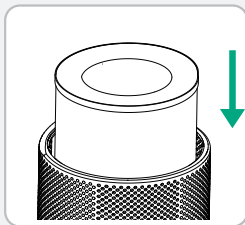

- 6 Then install the base, rotate and tighten the base along the direction marked "CLOSE".

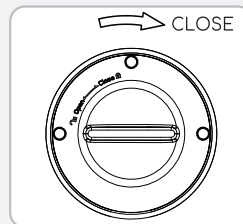



**\* Note**

Failure to properly place the filter and base on the air purifier, may result in air purifier not working properly.

## Resetting the Filter Replacement Alert

When the air purifier detects that the filter reaches the saturation value, the LED light keeps flashing in red.

After replacing with a new filter, the **FILTER REPLACEMENT ALERT** needs to be reset. Please restart the purifier and keep pressing the power button until the red light disappears.

## Maximum Purification Efficiency

In order to keep the best purification effect, it is recommended to keep the air purifier standing on the floor and keep it at least 1ft (30cm) away from the wall.

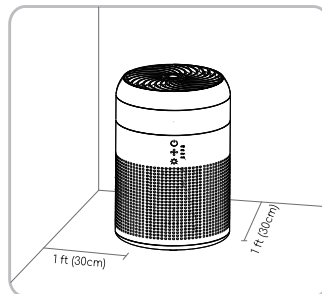

## Aromatherapy Box Use Steps

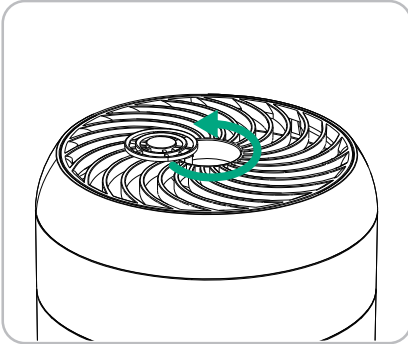

❶ Rotate to open the aromatherapy cover.

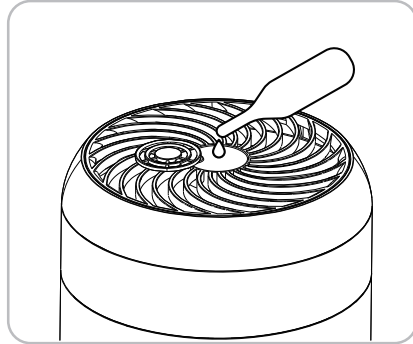

❷ Add 2-3 drops of your favorite essential oils to the aroma sponge. If changing different essential oils, please replace the sponge and wipe the aromatherapy box first.

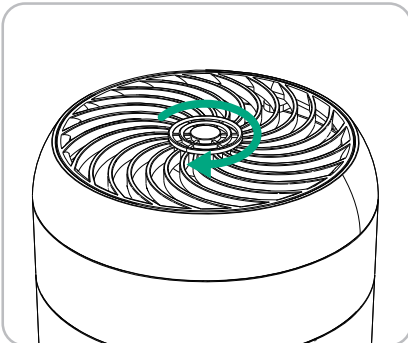

❸ Rotate to close the aromatherapy cover.

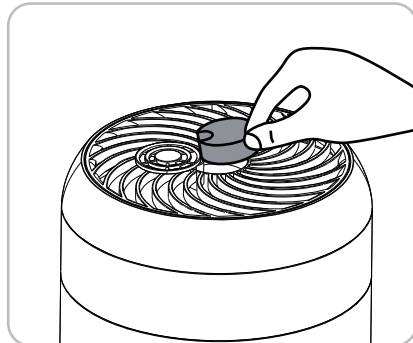

❹ It is recommended to replace the aroma sponge once a month and clean the aromatherapy box with a wet cloth.

### PLEASE NOTE:

- ❶ Only add essential oil to aroma sponge. Do not add essential oil to the air purifier to avoid corrosion.
- ❷ Only pure essential oil can be used. Do not use perfume or other fragrances.
- ❸ Please store unused sponges in a cool and dry place. Moisture will make the sponge yellow or grow mould.
- ❹ Please stay away from the fire.

## Caution

We recommend replacing the filter every 3-6 months. However, you may need to change your filters sooner or later depending on use frequency and air quality. For buying more filters, please visit Afloia website and contact Afloia customer service.

## Safety Instructions

---



- Ensure the product is unplugged before maintenance/Maintenance cleaning/Moving the device/ Changing the filter. Risk of injury due to electric shock.
- Do not immerse the air purifier into water or any liquid.
- Do not use abrasive, corrosive or flammable cleansers (such as bleach or alcohol) clean any part of the unit.
- Do not block the air intake or outlet.
- Do not use any spray cans with flammable contents near to the air purifier!
- Do not use a vacuum cleaner to clean the filter.
- Use a soft cloth with neutral cleanser to clean away any dust or debris from the surface of the air purifier and air intake/vent.
- If you do not use it for a long time, please turn on the air purifier for a few minutes from time to time to ensure a good performance.
- Do not use the device near a smoke detector. Air blowing towards a smoke detector could delay the alarm or not trigger at all.
- Only use the air purifier in living quarters and within the specified technical parameters.
- Do not expose the air purifier to direct sunlight, a naked flame or heat.

- ▼ Not following this user manual may result in your device not working. Please read the following measures accordingly if you are having problems with your device. If you are still having problems, please contact our Customer Service Centers.

Problem	Checklist	Recommendation
The product won't work even if I press the Power button.	Are you in a black out?	Check the power supply.
	Is the power cord plugged into the power outlet?	Put the power plug in a power outlet.
No air is blowing out.	Is there material blocking the intake or air vent?	Remove material from vent/intake. Check if plastic packaging has been removed from filter.
	Is the air purifier placed where the intake or blocked preventing air from moving freely?	Remove objects blocking the air purifier or place it elsewhere.
	Air purifier is on but fan does not work.	Unplug from the wall and contact Afoia customer service: <a href="mailto:service@afoia.com">service@afoia.com</a>
Loud Noises	Is there anything stuck in the fan or air intake/vent?	Please remove any objects you see from the fan intake/vent.
	Is the air purifier tilted on its side?	Make sure the base is level on a flat surface.
	Is the fan really loud?	Set your air purifier to a lower fan speed to reduce the noise.

Problem	Checklist	Recommendation
Coming out nasty smell	Is the air purifier in a place with a lot of smoke and odor?	The performance of the air purifier may decrease over time if there is excessive smoke and odor in the area. To remedy this, please air out the room before using the air purifier.
	Should I clean or replace my filter?	Check the filter replacement indicator and clean or replace the filter if necessary.
	Do you smell plastic?	It is common that in the first uses the smell of plastic will be emitted. It will eventually go away. If not, please contact our customer service centers.
	Is there a burning smell?	Turn off your air purifier, unplug it from the wall and contact our customer service center.
The air purifier is not purifying the area well.	The air purifier may be placed in an area with no ventilation, or there is an obstacle near it.	Ventilate the room and then use the product. Use the product in an area not exceeding its coverage limit. (Avoid placing the device where it is well ventilated like a door or window.)
	Is there any dust in the pre-filter?	Wipe the Pre-Filter
	Are there any objects blocking the air intake/vent?	Please remove any objects from the intake/vent.
	Have you removed the filter from its packaging?	The plastic bag of the filter may not have been removed, so please open the cover and check if the plastic bag is removed.
	Is the filter dusty? Maybe it is time to replace the filter.	Change the filter if it looks like it needs to be replaced.
	Is intake/vent dusty?	Clean the air vent/intake.
The filter replacement indicator still stays red after I changed the filter.	Have you reset the filter change button?	Press and hold the power button for 7 seconds to reset the filter replacement alert.

Note : If these suggestions do not work accordingly, please contact Aflora customer service and await instructions. Do not disassemble, repair or fix anything by yourself.

Category	Air Purifier
Model	Demi
Power Supply	Input: 100-240V 50/60Hz Output: 12V-1A
Rated Power Input	12W
Dust Collecting Method	Mechanical dust collecting method
Product Size	D6.3 x W6.3 x 10.39 inch / D160 x W160 x H263.75mm
Product Weight	2.53lbs / 1.15kg
Place for Use	For indoors

1.The information (exterior, design, and specifications) provided in this User Manual is subject to change without prior notice to improve the quality of the device.

2.Room coverage\*\* based on the Air Change Per Hour or ACPH which is how many times per hour the air in your room will be fully purified.

## Inquiry about Malfunction

---

Product parts may wear out due to heat, moisture, dust and other causes over time, which may cause malfunction of the product.

In the case that

- 1.Something other than the symptoms coming under "Troubleshooting";
- 2.You can feel electricity when you touch the product with your hands;
- 3.The power is supplied, but the fan does not work;
- 4.Other malfunctions occur.



Please stop using the product.

Please unplug the product and contact [service@ofloia.com](mailto:service@ofloia.com)

### Warranty

For questions about our warranty or to look at our other products, please visit our website: [www.ofloia.com](http://www.ofloia.com)



# AIR PURIFIER DEMI USER MANUAL

We provide satisfying consultation and services concerning your complaints, suggestions, and recommendations upon receiving your troubled product model name, status, and contact information.

- After reading this manual, keep it in a place easily accessible to the user for future reference.
- Caution : Please read this manual carefully to ensure safety and a longer product lifespan.