

ORDER DETAILS	
MOCKUP NO.	WUFOO.
INQUIRY NO.	INQUIRY.V1
ORDER NO.	
PRODUCT DETAILS	
SIZE	Ø43MM*3.3MM
CHIP FINISH	SMOOTH OR TEXTURED
QUANTITY	
VALUE ADDITION	
PRINTING EFFECT	CMYK

————— DIE CUT LINE

REMARKS:  
 - Artwork should be submitted in AI, EPS, PDF, CDR, PSD.  
 - For JPEG, PNG and PSD please submit your artwork with a minimum of 300dpi

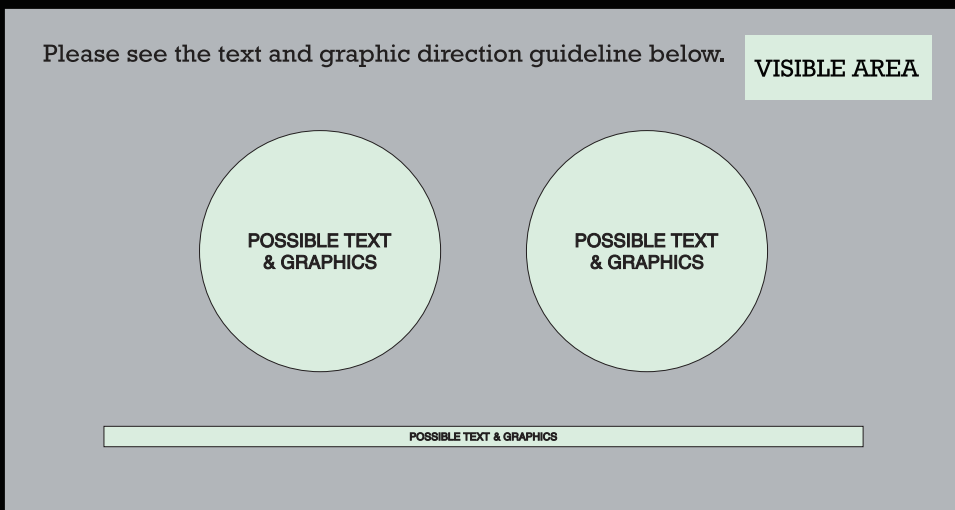

I accept the artwork and understand that any mistakes or omissions is my responsibility.

DATE: .....

PRINT NAME: .....

APPROVAL SIGNATURE: .....

**FRONT**

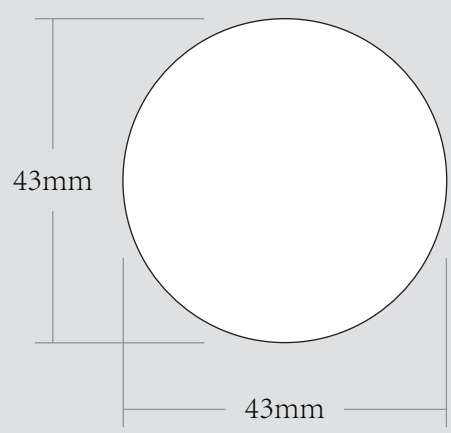

**BACK**

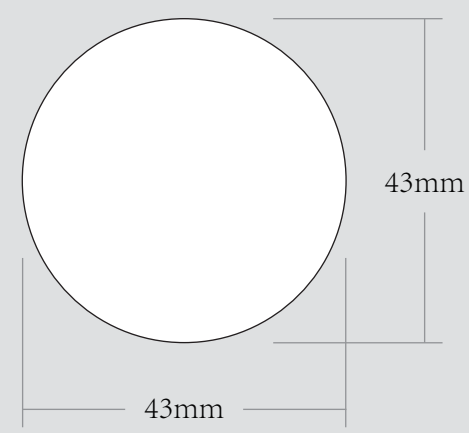

**SIDE**

