

ORDER DETAILS	
MOCKUP NO.	WUFOO.
INQUIRY NO.	INQUIRY.V1
ORDER NO.	
PRODUCT DETAILS	
SIZE	SINGLE WIDTH SIZE (SW)
PAPER TYPE	
QUANTITY	
BOX PACKING	50 BOOKLETS A BOX
VALUE ADDITION	
PRINTING EFFECT	CMYK

\_\_\_\_\_ DIE CUT LINE  
 - - - - - FOLD LINE  
 - - - - - BLEED LINE

**REMARKS:**  
 - Artwork should be submitted in AI, EPS, PDF, CDR, PSD.  
 - For JPEG, PNG and PSD please submit your artwork with a minimum of 300dpi

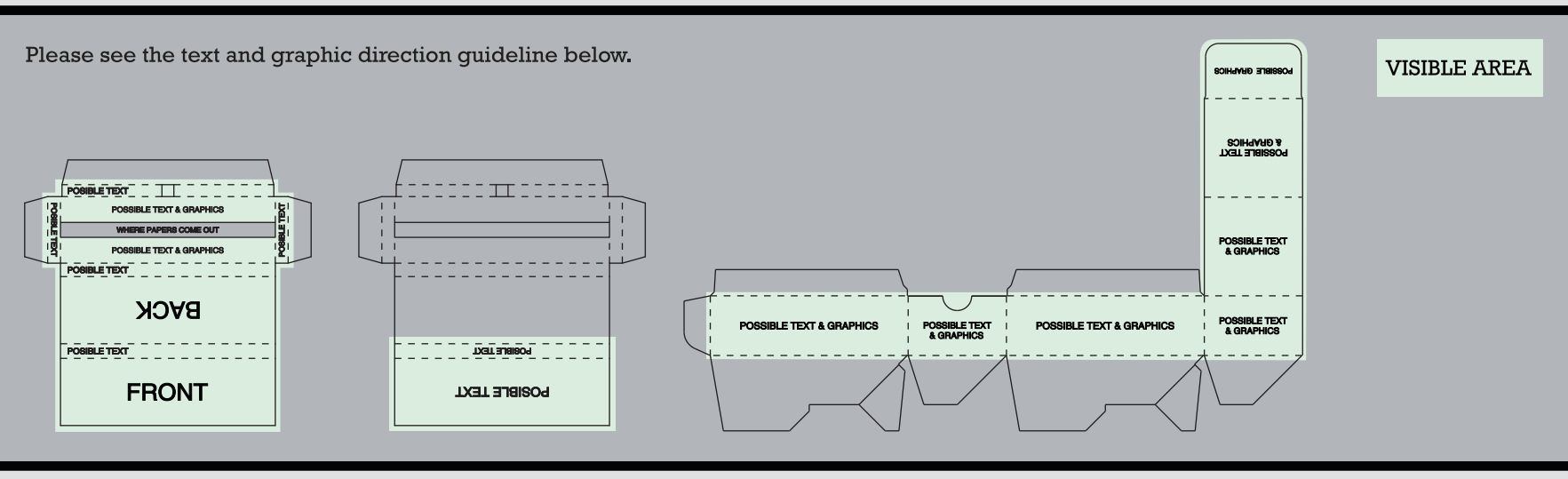

I accept the artwork and understand that any mistakes or omissions is my responsibility.  
 DATE: .....  
 PRINT NAME: .....  
 APPROVAL SIGNATURE: .....

**OUTSIDE**

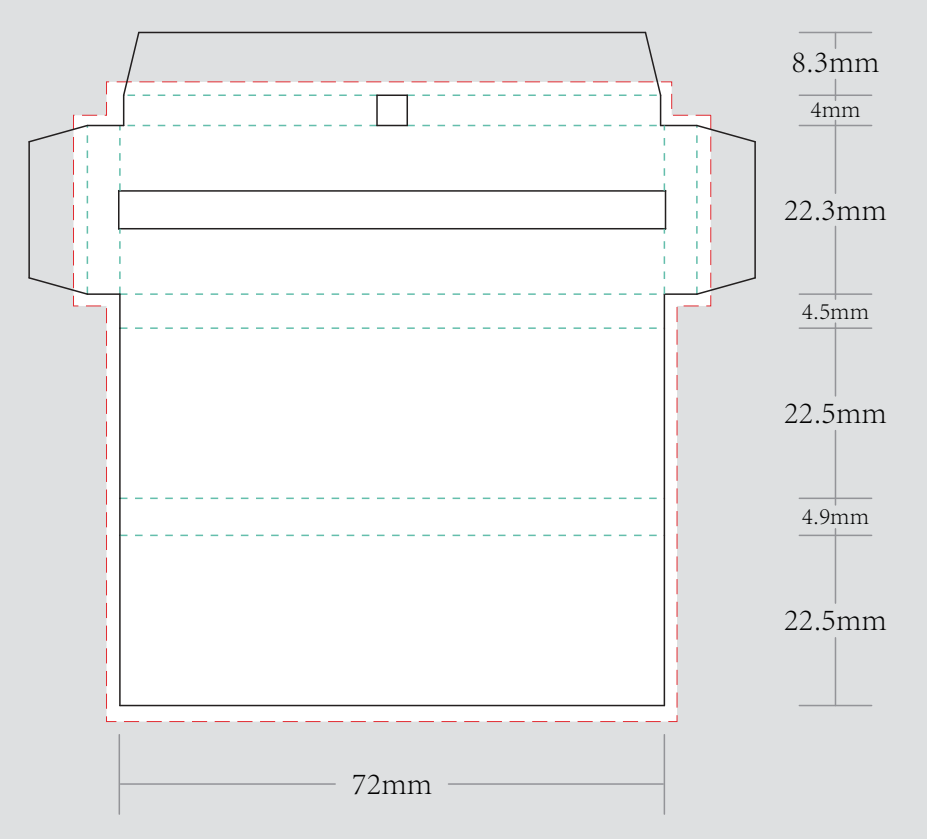

**INSIDE**

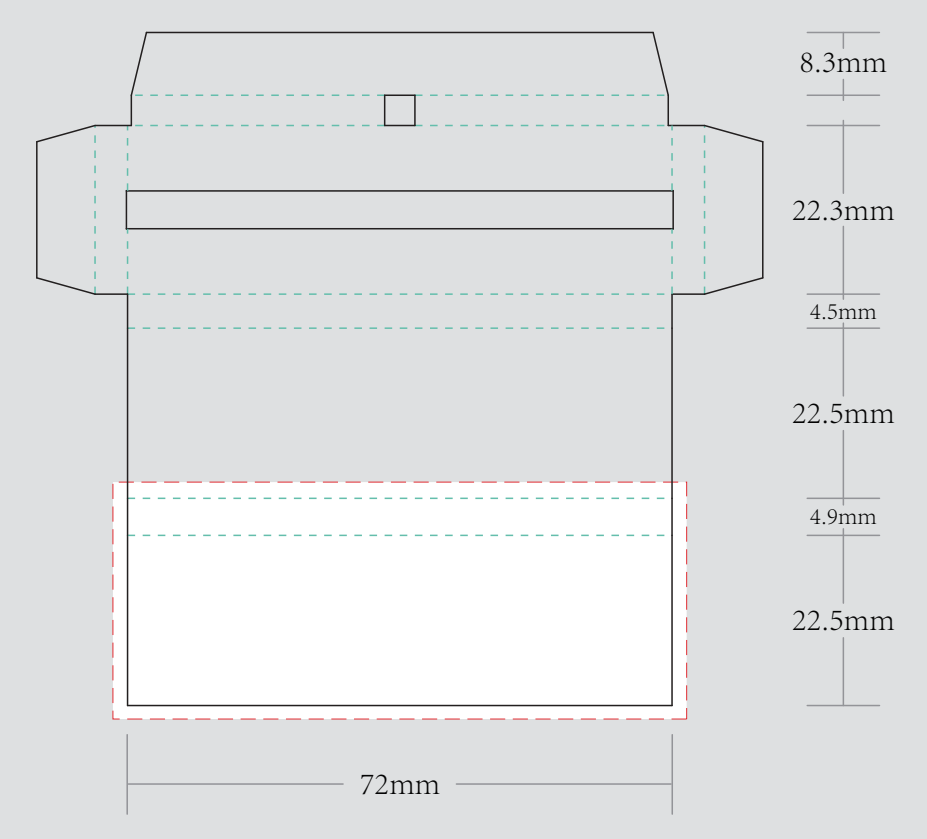

**EXAMPLE**

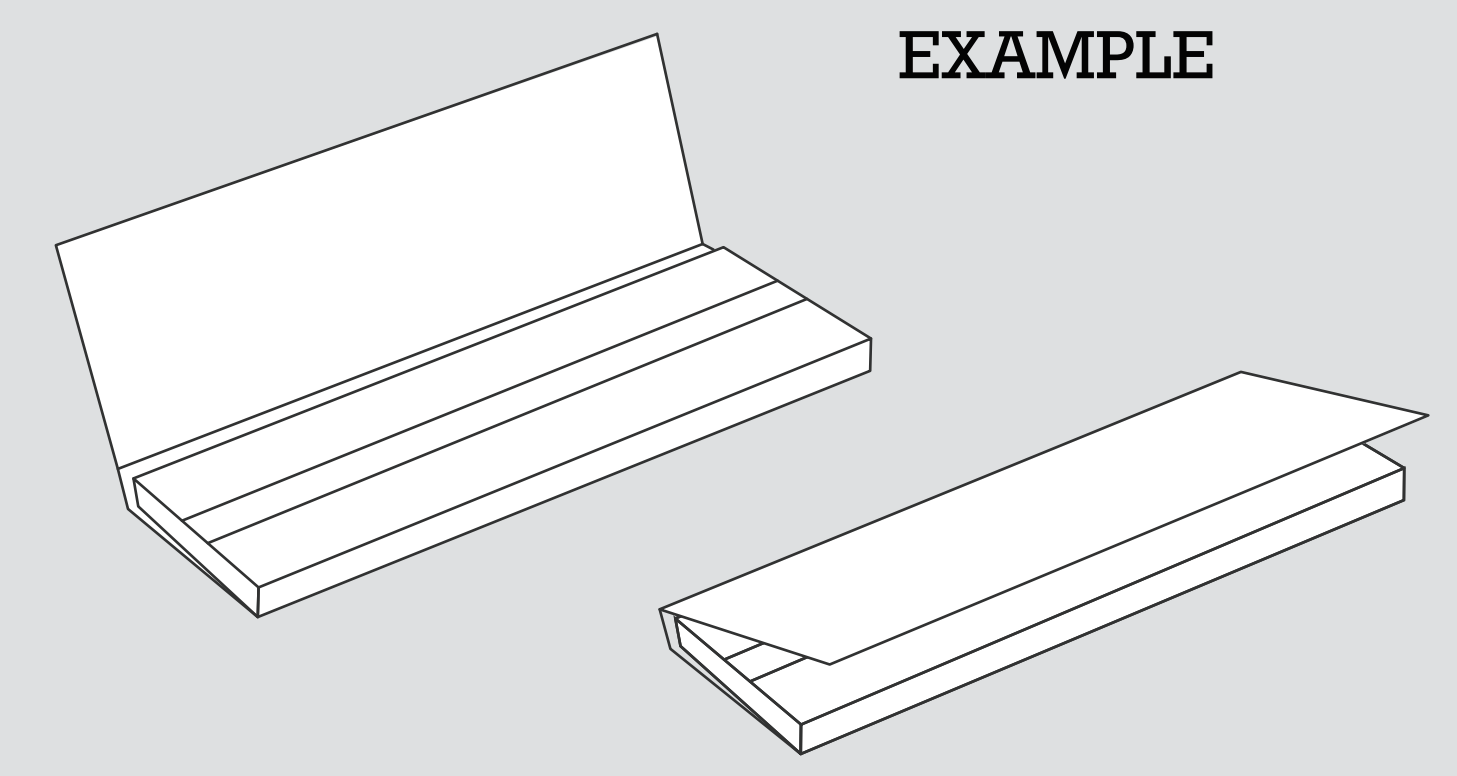

**DISPLAY BOX**

