

ORDER DETAILS	
MOCKUP NO.	WTR02
MOCKUP NO.	MOCKUP V1
ORDER NO.	
PRODUCT DETAILS	
SIZE	KING TALL TIP
MARK TYPE	
QUANTITY	
BK PACKING	1.600 COVER A BOX
CONTAINER CAPACITY	15 BAKES / 1.00
PRINTING EFFECT	CMYK

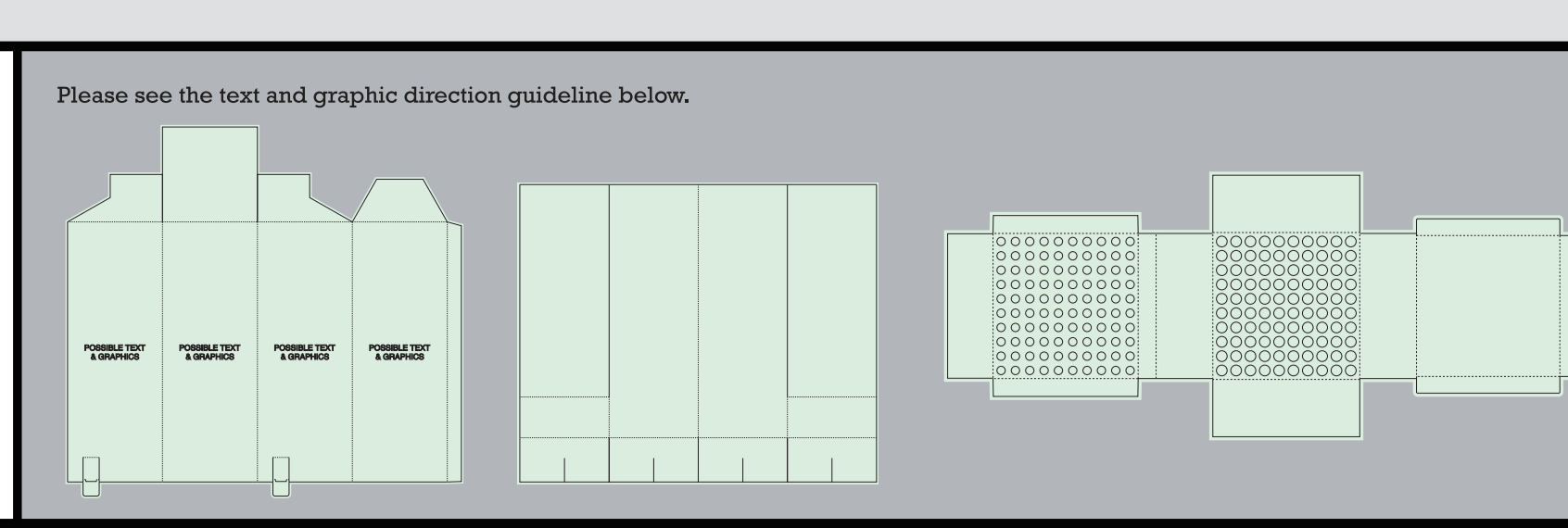

DIE CUT LINE
FOLD LINE
BLEED LINE

VISIBLE AREA

I accept the artwork and understand that any mistakes or omissions is my responsibility.

DATE: _____

PRINT NAME: _____

APPROVAL SIGNATURE: _____

OUTSIDE COVER

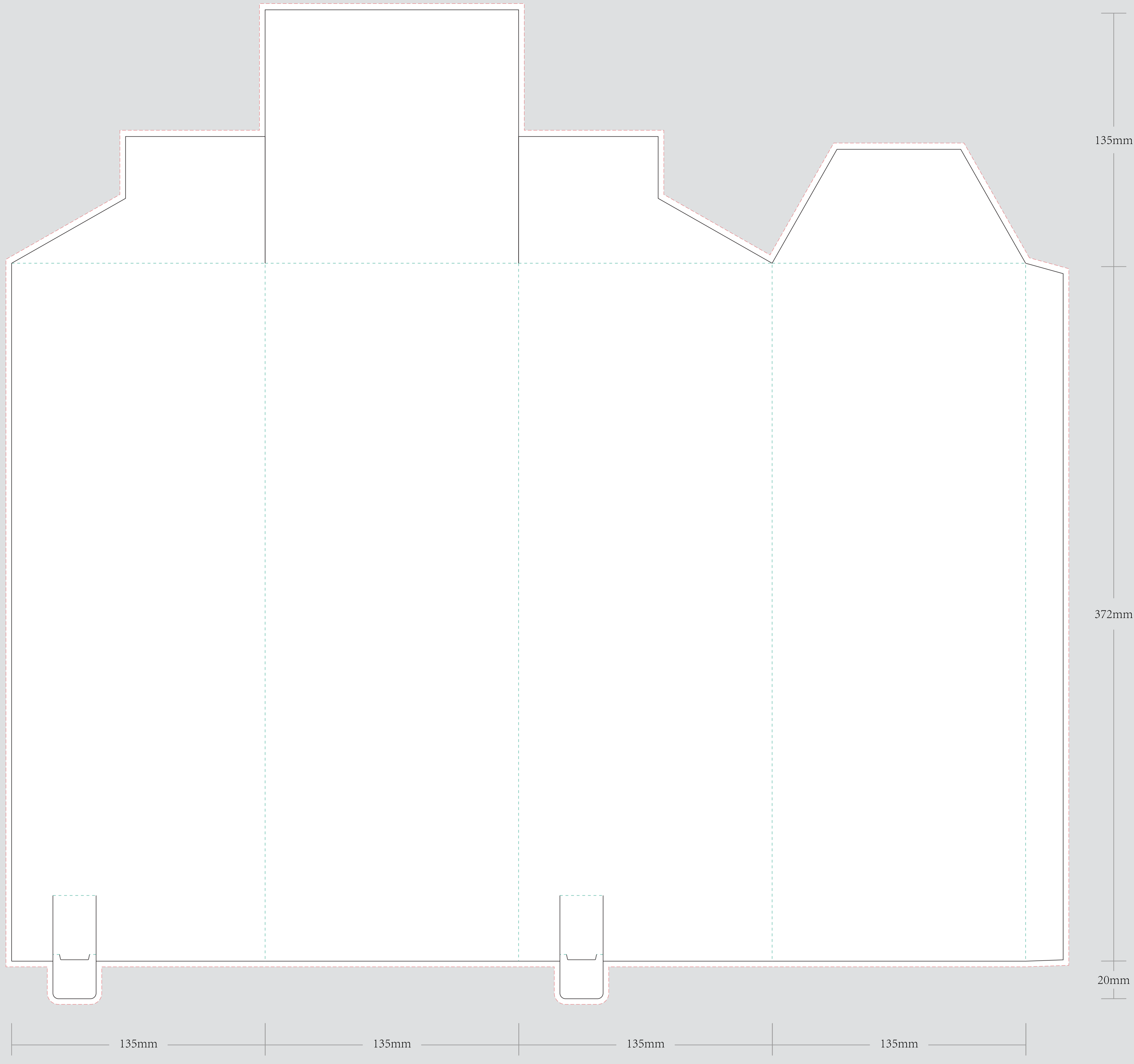

PAPER

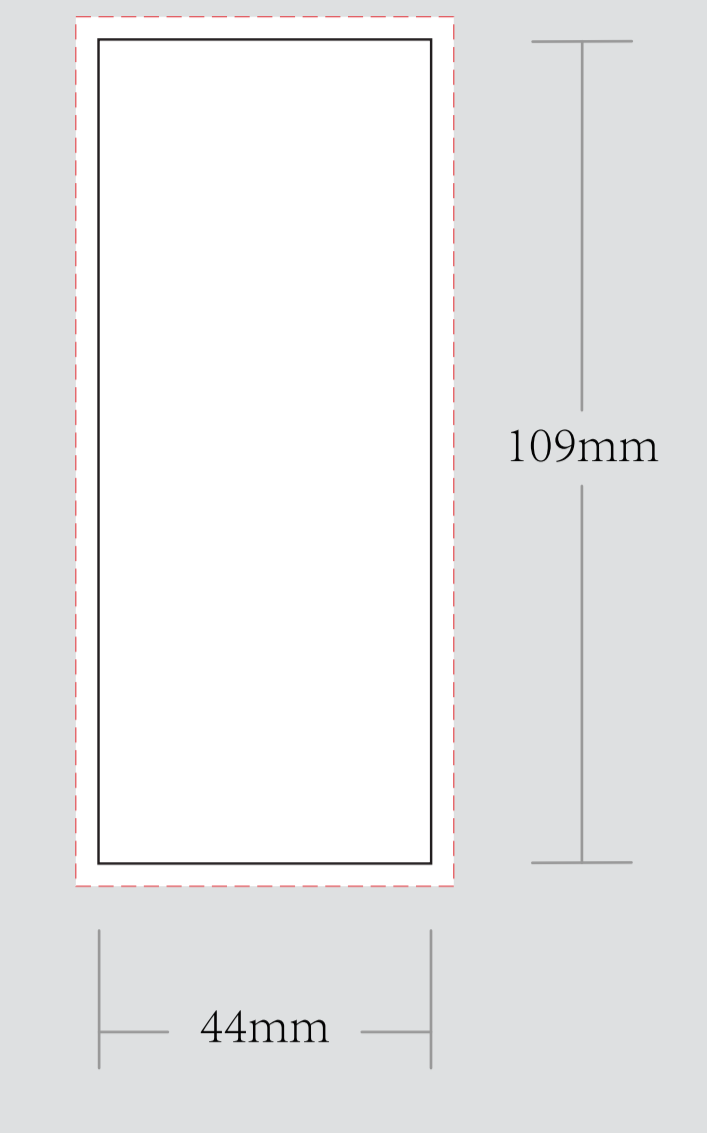

TIPS/CRUTCH

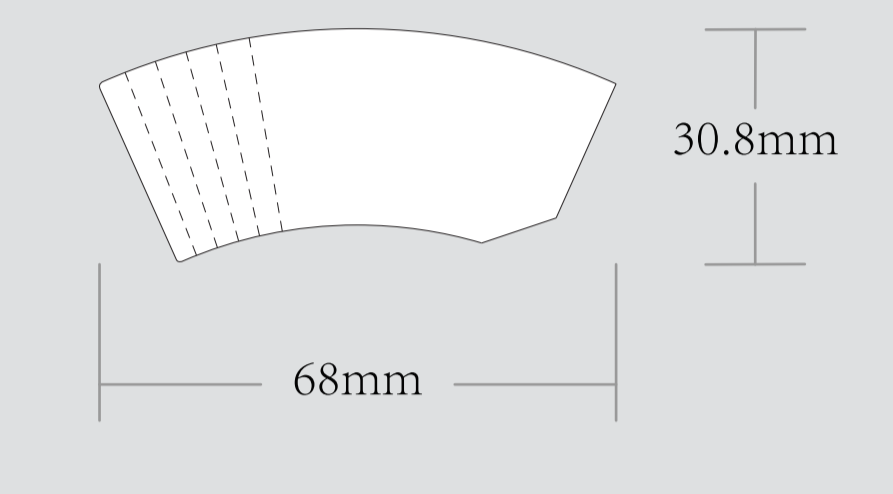

PRE ROLL CONE EXAMPLE

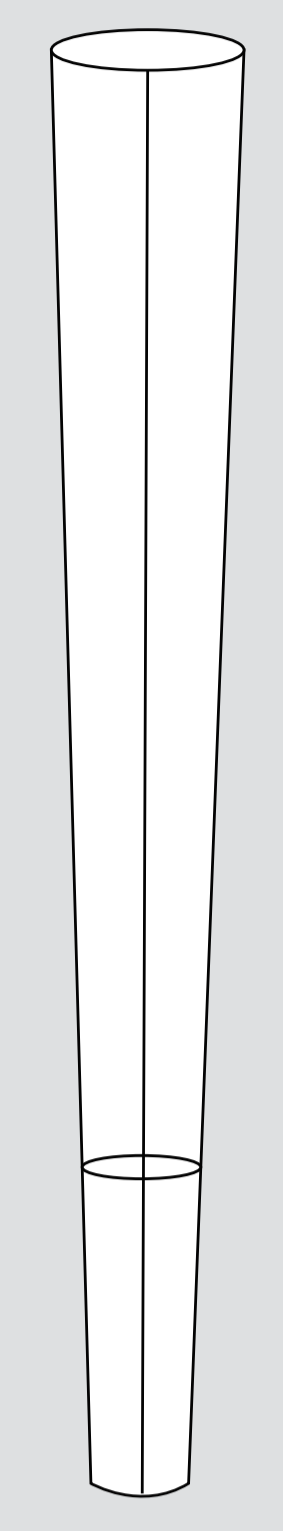

THIS 3D MOCK UP IS JUST AN EXAMPLE AND NOT AN ACTUAL

BASE

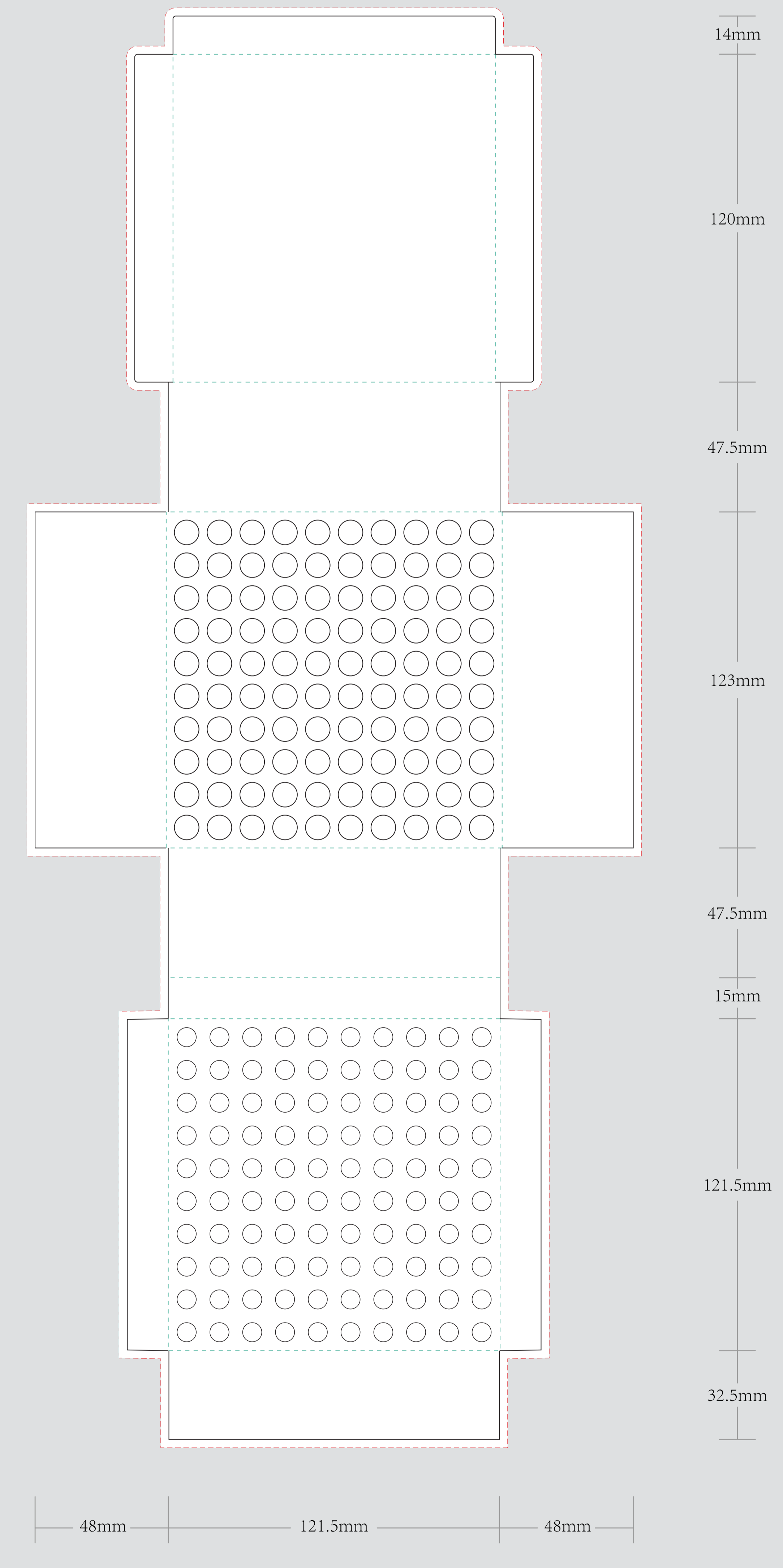

BOX ASSEMBLED

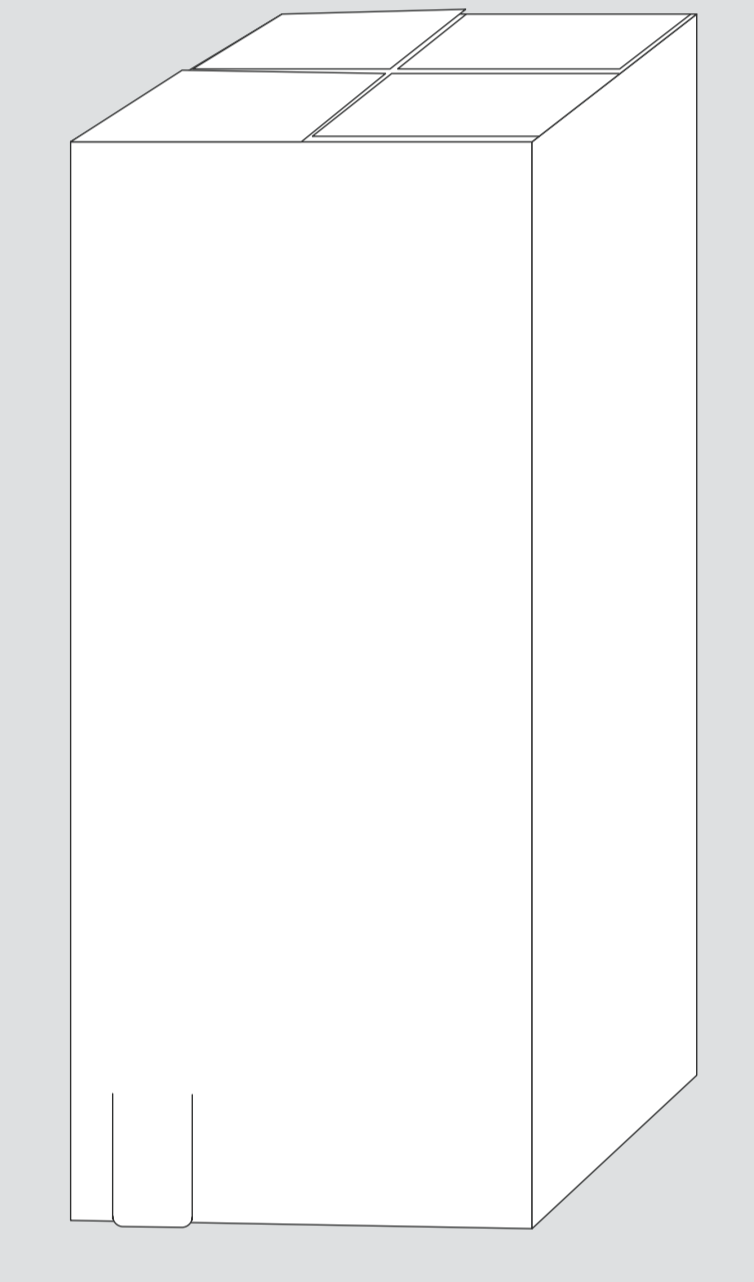

INSIDE COVER

