

ORDER DETAILS	
MOCKUP NO.	WUFOO
INQUIRY NO.	INQUIRY.V1
ORDER NO.	
PRODUCT DETAILS	
SIZE	CONE-6 CONE PER PCS-ACETATE BOX-88/59MM
PAPER TYPE	
QUANTITY	
BOX PACKING	18 ACETATE BOXES PER DISPLAY
VALUE ADDITION	
PRINTING EFFECT	CMYK

\_\_\_\_\_ DIE CUT LINE  
 - - - - - FOLD LINE  
 - - - - - BLEED LINE

**REMARKS:**  
 - Artwork should be submitted in AI, EPS, PDF, CDR, PSD.  
 - For JPEG, PNG and PSD please submit your artwork with a minimum of 300dpi

Please see the text and graphic direction guideline below.

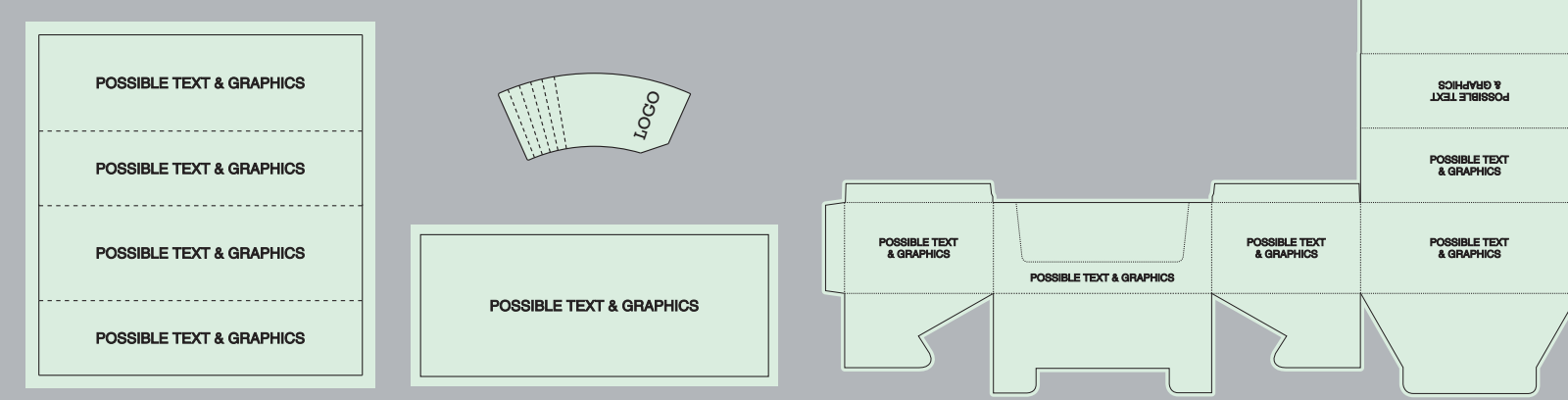

I accept the artwork and understand that any mistakes or omissions is my responsibility.  
 DATE: .....  
 PRINT NAME: .....  
 APPROVAL SIGNATURE: .....

### PLASTIC BOX

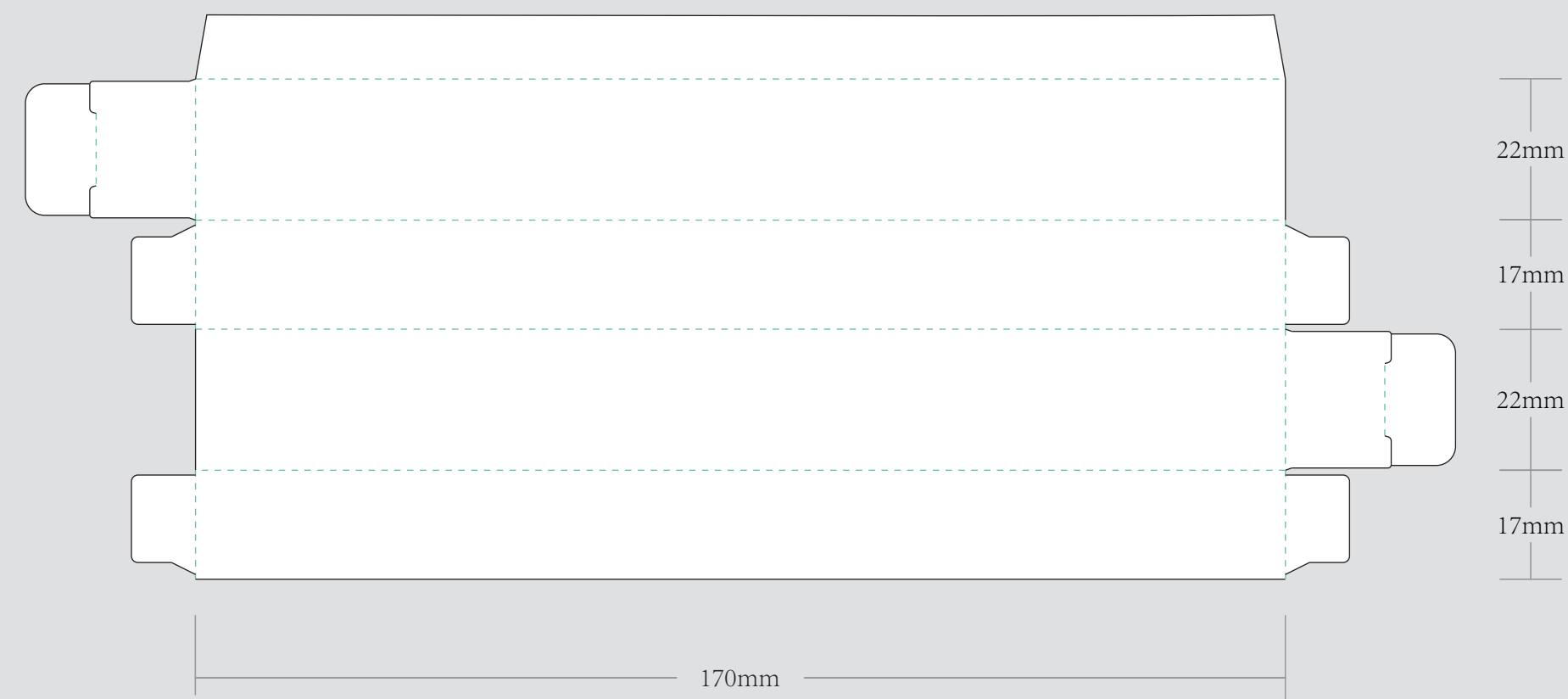

### SLEEVE

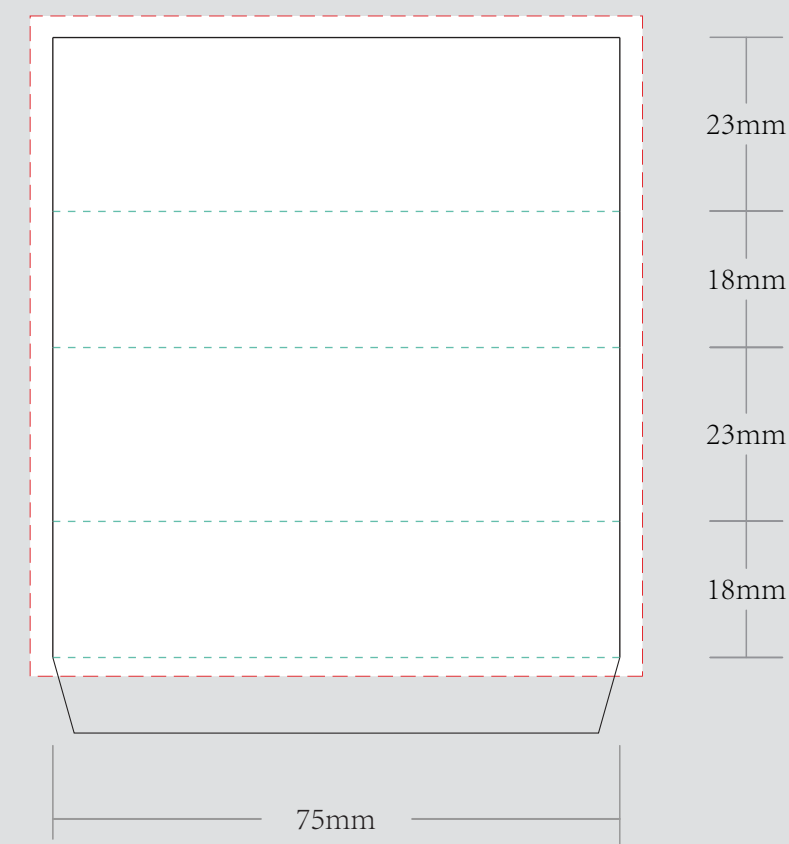

### EXAMPLE

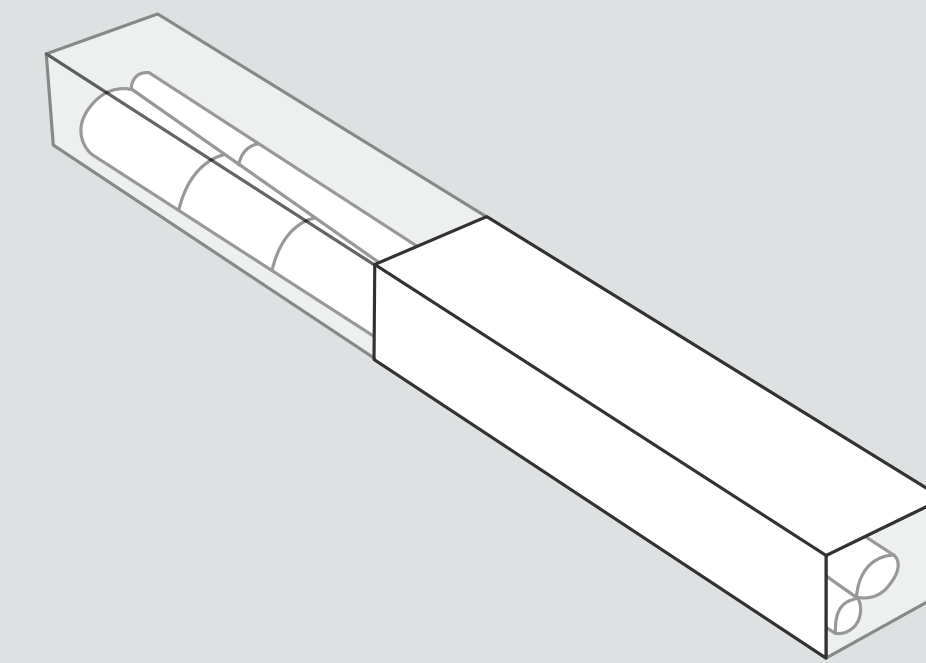

### CONE PAPER



### TIPS/CRUTCH

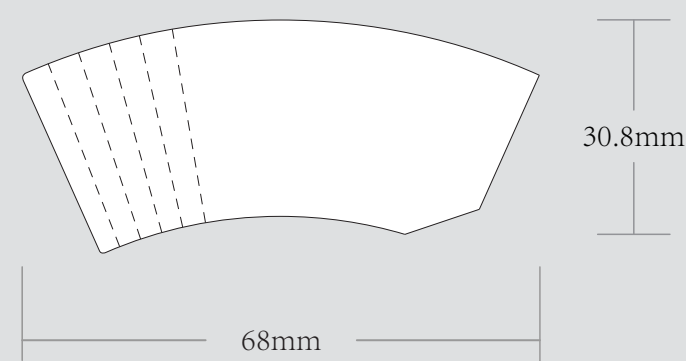

### OUTSIDE STICKER WRAPPED ON TIPS

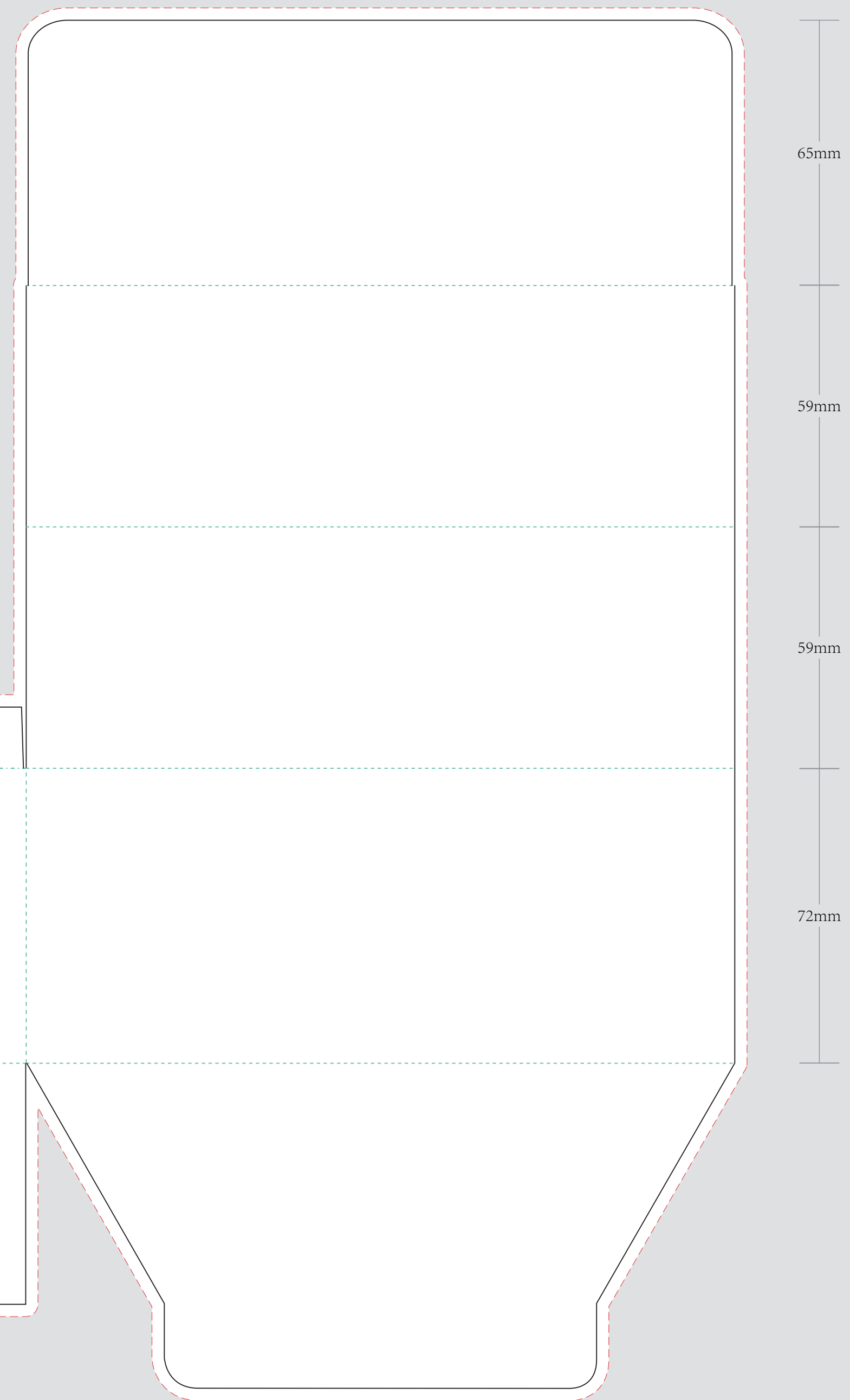
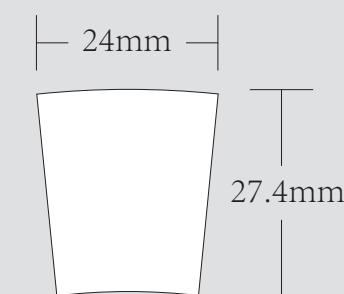

**Tear Line**  
这条线做撕割线

**Tear Line**  
这条线做撕割线

### DISPLAY BOX

