

ORDER DETAILS	
MOCKUP NO.	WUFOO.
INQUIRY NO.	INQUIRY.V1
ORDER NO.	
PRODUCT DETAILS	
SIZE	DIA.62*71MM
COLOR	BLACK
QUANTITY	
VALUE ADDITION	
PRINTING EFFECT	CMYK

————— DIE CUT LINE

REMARKS:
 - Artwork should be submitted in AI, EPS, PDF, CDR, PSD.
 - For JPEG, PNG and PSD please submit your artwork with a minimum of 300dpi

Please see the text and graphic direction guideline below.

VISIBLE AREA

POSSIBLE TEXT & GRAPHICS

POSSIBLE TEXT & GRAPHICS

I accept the artwork and understand that any mistakes or omissions is my responsibility.

DATE:

PRINT NAME:

APPROVAL SIGNATURE:

TOP

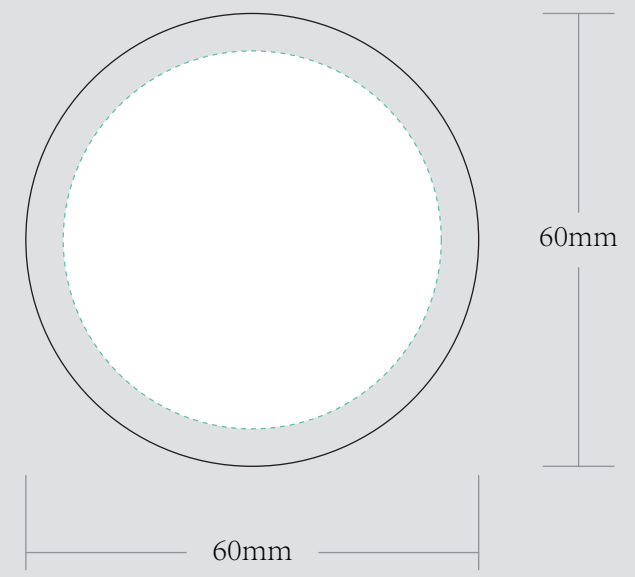

BOTTOM

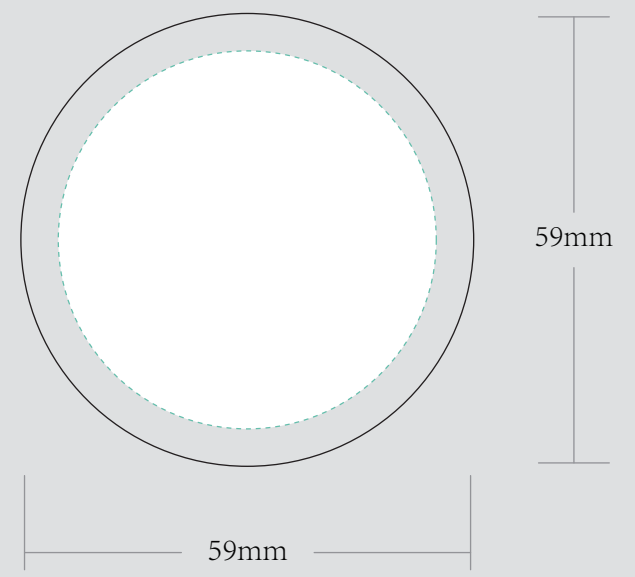

EXAMPLE



Please put the design in green line rectangle
 设计做在绿色虚线内