

WOLF CLASSIC™

HERITAGE SERIES

PRODUCT SPECIFICATIONS

Effective September 2023



WOLF HOME PRODUCTS®

WOLF CLASSIC

Wolf Classic provides the right cabinetry for every project and budget. Today's most popular door styles, carefully curated finishes and practical storage solutions make your designs an affordable and beautiful reality. Add in a wide selection of SKUs, accessories, and mouldings for even greater design flexibility. Wolf Classic cabinets are hand-crafted, built with solid hardwood components and expertly finished for a beautiful and long-lasting appearance. And they're backed by our industry-leading five-year warranty for peace of mind. With Wolf Classic, you'll enjoy the ideal combination of quality and value.

HERITAGE SERIES:

Wide choice of styles plus special-order items

- Broadest offering of door styles, finish options and SKUs, including special order SKUs, ADA and UD cabinets
- Direct truckload availability
- Personalized Solutions

THINKING OUTSIDE THE BOX

Personalized Solutions lets you modify many of our popular Wolf Classic cabinets to fit any application or style. Wolf Classic becomes a complete cabinetry solution — so not only can you make a customized design statement, but you'll also enjoy extra design flexibility, easily accommodate the character of any space and incorporate the latest trends in vibrant colors — all in a fraction of the time.

- **Modify cabinets** with more design options to meet the needs of your space and satisfy unique style
- **Add storage solutions**, like pull-out organizers and tip-out trays, pre-installed, which ensures more precise and timesaving installation
- **Select trending colors** and color combinations through a wider variety of complementary paints, letting you add even more creative flair

CABINET SPECIFICATIONS

Face Frame	3/4" thick x 1 1/2" wide solid wood face frame	X
Side Panels	1/2" thick plywood with color matching exterior	X
Back Panel	1/2" thick plywood	X
Top/Bottom	1/2" thick plywood	X
Interior	Natural maple interior - Stained finishes - Pewter and Opal Paint	X
	White interior - White paint	X
Shelves	3/4" thick plywood, adjustable, with locking shelf clip	X
	Bull-nosed, foil covered front edge	X
	Half-depth, adjustable base	X
Corner Blocks	3/4" thick all-wood	X
Hanging Rail	1/2" thick - Horizontal	X
Drawers	5/8" thick solid wood, clear finished	X
	Dovetail - 4" high	X
	1/4" thick plywood bottom	X
Glides	Soft Close, full extension undermount 75 lb. weight capacity	X
Hinges	Soft Close, 6-way adjustable	X

Note: Hinges Type Rules (Soft-close versus Self-close)

- A door with 2 hinges gets 1 Soft-close and 1 Self-close hinge
- Unless the door $\geq 16 \frac{15}{16}$ " wide **AND** ≥ 21 " High, then 2 Soft-close hinges
- A door with 3 hinges gets 2 Soft-close hinges (outer hinges) and 1 Self-close hinge (center)

CABINET REVEALS

Full Overlay

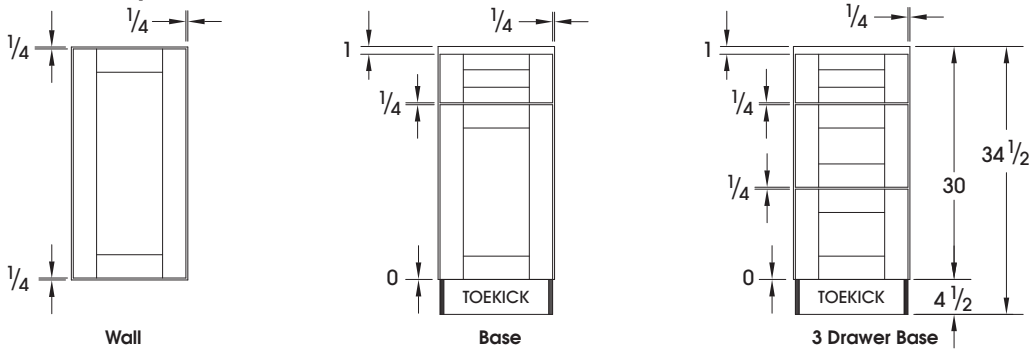

Standard Overlay

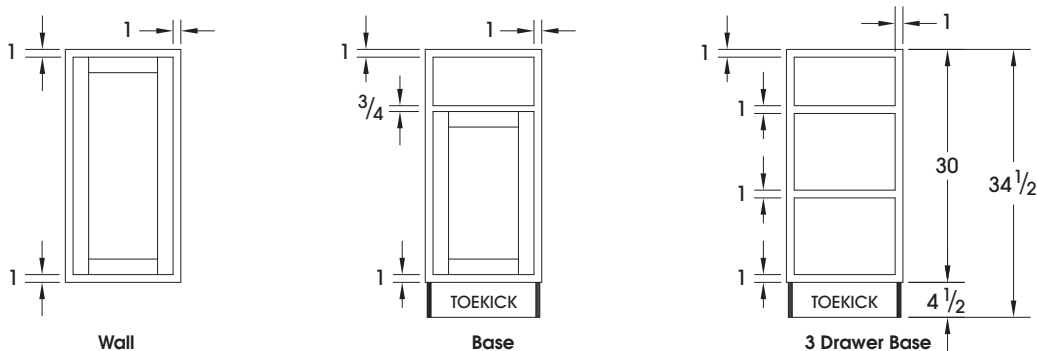

DOOR STYLES

HANOVER

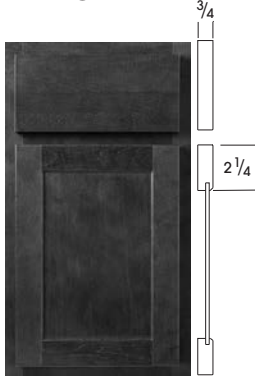

- **Standard Overlay**
- One-piece Drawer Front
- Flat Panel Door
- Maple with Veneer Center Panel - Stains
- HDF with MDF Center Panel - Paint

DARTMOUTH

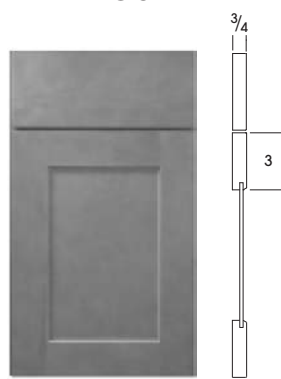

- **Full Overlay**
- One-piece Drawer Front
- Flat Panel Shaker Door
- Maple with Veneer Center Panel - Stains
- HDF with MDF Center Panel - Paint

DARTMOUTH 5-PIECE

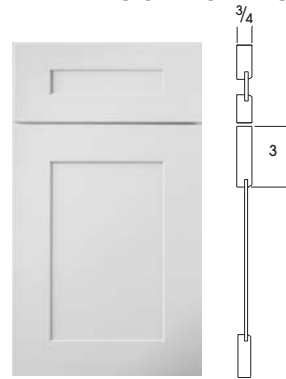

- **Full Overlay**
- 5-piece Flat Panel Drawer Front
- Flat Panel Shaker Door
- Maple with Veneer Center Panel - Stains
- HDF with MDF Center Panel - Paint

YORK

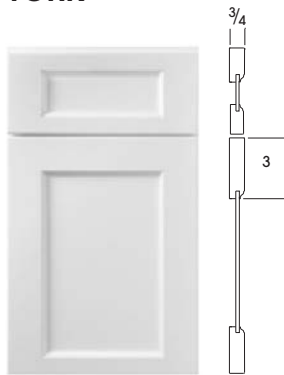

- **Full Overlay**
- 5-piece Drawer Front
- Flat Panel Door
- Maple with Veneer Center Panel - Stain
- HDF with MDF Center Panel - Paint

WAVERLY



- **Full Overlay**
- 5-piece Drawer Front
- Flat Panel Shaker Door
- Maple with Veneer Center Panel - Stain
- HDF with MDF Center Panel - Paint

BERWYN

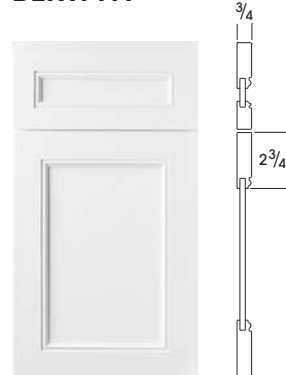

- **Full Overlay**
- 5-piece Drawer Front
- Mitered Door with Flat Center Panel
- Maple with MDF Center Panel

WOOD CHARACTERISTICS & VARIATIONS

Naturally occurring wood characteristics such as variations in color, grain, mineral streaks and knots are not considered defects.

Color variations are a natural occurrence due to species, age, character of cabinets, and exposure to UV light and sunlight. Such variations and changes are not considered defects. For these reasons, new and/or replacement cabinets may not match display samples and/or existing cabinets.

Warping is the bending or twisting of a part. To measure a door or shelf, lay the product on a flat surface and measure the gap from the surface to the part. The standard allowable tolerance for wood is 1/8" per lineal foot. Materials that fall within specification are considered acceptable, as a part of the natural characteristics of wood.

Wolf Classic's Hanover, Dartmouth, York and Waverly door styles use HDF rails and stiles with MDF center panels when painted. Using High/Medium Density Fiberboard provides a smooth, painted surface that does not expand or contract and reduces visible seams where pieces are joined. Fiberboard also provides a stable substrate that minimizes warping and provides better moisture resistance - an industry standard material for painted product.

FINISH AVAILABILITY

DOOR STYLE	STANDARD FINISHES	CODE	IN STOCK	SPECIAL ORDER
Dartmouth	Brownstone	024	X	X
	Dark Sable	014	X	X
	Grey Stain	023	X	X
	Hazelnut	046	X	X
	Honey	003	X	X
	Pewter Paint	022	X	X
	White Paint	005	X	X
Dartmouth 5-piece	Grey Stain	5023	X	X
	Hazelnut	5046	X	X
	Pewter Paint	5022	X	X
	White Paint	5005	X	X
York	Grey Stain	021	X	X
	White Paint	020	X	X
Berwyn	Opal Paint	040	X	X
Waverly	Hazelnut	047	X	X
	White Paint	048	X	X
Hanover	Grey Stain	039	X	X
	White Paint	038	X	X

FINISH PROCESS

- All surfaces are machine-sanded.
- Dust particles are removed before entering each spray machine.
- Product enters an automated finish system where solvent-based pigment stain is applied.
- Product is sealed and put through a pre-cure drying process.
- Complete cure is done with slow bake process.
- All edges of parts are hand-sanded before being put in a brush-sanding machine.
- Final topcoat is applied and put through a pre-cure process followed by slow bake for final, thorough curing.
- Clear finishes use a catalyzed varnish, and paint finishes use a post-catalyzed lacquer.
- Products are inspected for defects, cleanliness and smoothness.
- The front side of the products gets a stain coat, a sealer coat and final top coat. The backs of drawer fronts and doors get a stain coat and a sealer coat.

COMPLEMENTS PAINT

There's a whole new way to make your kitchen your style. Thanks to Wolf Classic Complements, you can now personalize your kitchen and bath with accent colors for base cabinets, islands, vanities and more. They're the perfect complement to our most popular Wolf Classic styles and colors.

- Bayside** – A rich, medium blue. This slate blue hue is extremely versatile and will accentuate every style in any room.
- Biscayne** – The darkest of our Wolf Classic Complements blue finishes. A deep, rich blue shade closest to navy is both elegant and timeless.
- Cape** – The just-right neutral, a light, breezy tan finish. Vibes of tranquility and luxury, this color works as the foundational backdrop for other design elements or as the main feature.
- Currant** – A vibrant and fiery red tone. Sure to infuse life into any space it graces, this striking red commands attention and inspires creativity.
- Evergreen** – A lush and vivid gemstone green. A surefire way to add drama and luxury to any room, this color is a testament to bold expression.
- Goldleaf** – As its name suggests, a loud golden yellow. A daring and exuberant color choice, this burst of sunlight is for those looking to make a vivid and memorable statement in their décor.
- Juniper** – A deep, dusty grey-green hue. Rustic, yet refined, this finish will create a warm and charming focal point in any living space.
- Laurel** – A bold, seagrass green. A showcase of any unique, personal style, this finish will brighten and energize upon first glance.
- Midnight** – A refreshing black finish void of any undertones. With a velvety look, this strong hue will add dimension and make a statement no matter what room it's used in.
- Palmetto** – A nod to green with grey undertones. This subtle, light green shade provides a softer color contrast while also adding plenty of character.
- Seabreeze** – A cool-toned blue-green finish most like robin's egg blue. Just the right amount of color for a clean, crisp accent in any application.
- Seaport** – More royal than Bayside and lighter than Biscayne, this strong mid-range blue is bold, yet sophisticated while providing endless depth.
- Silhouette** – A shade lighter than Midnight, a deep slate grey. This dark finish embodies a sense of depth and drama, casting a subtle yet commanding presence.
- Stonybrook** – An inviting combination of brown and grey make a strong, earthy finish. Adaptable and sure to make any neutral space interesting and inviting.

COMPLEMENTS PAINT STYLE CODES

All cabinet interiors will be white, including cabinets prepped for glass and mullion door cabinets
 Available on most stock cabinets and accessories
 Available on Dartmouth, Dartmouth 5-Piece, Hanover, York and Waverly door styles



Style Codes					
Complements Paint	Hanover	Dartmouth	Dartmouth 5-Piece	York	Waverly
Bayside	03801	00501	500501	02001	04801
Biscayne	03802	00502	500502	02002	04802
Cape	03810	00510	500510	02010	04810
Currant	03811	00511	500511	02011	04811
Evergreen	03812	00512	500512	02012	04812
Goldleaf	03813	00513	500513	02013	04813
Juniper	03807	00507	500507	02007	04807
Laurel	03808	00508	500508	02008	04808
Midnight	03803	00503	500503	02003	04803
Palmetto	03804	00504	500504	02004	04804
Seabreeze	03805	00505	500505	02005	04805
Seaport	03806	00506	500506	02006	04806
Silhouette	03814	00514	500514	02014	04814
Stonybrook	03809	00509	500509	02009	04809

NOMENCLATURE

B = Base	LC = Linen Cabinet	STCROWN = 2-Pc. Starter Crown
B_FH = Base with Full Height Door	LCD = Linen Cabinet with Drawer	TFOOT = Tapered Foot
BC = Base Corner	LEG = Leg	U = Utility
BEC = Base End Cabinet	LGCROWN = Large Crown	V = Valance
BER = Base Easy Reach	LS = Lazy Susan	VB = Vanity Base
BFOOT = Bun Foot	MBAT = Batten	VBL = Vanity Base Left Combo Unit
BK = Bookcase Cabinet	MICW = Inside Corner	VBR = Vanity Base Right Combo Unit
BMW = Base Microwave Cabinet	MLR = Light Rail	VDB = Vanity Drawer Base
BOXHOOD = Box Hood	MOCW = Outside Corner	VDT = Vanity Drawer Tray
BP = Beaded Panel	MQR = Quarter Round	VS = Vanity Sink Base
BSKIN = Base Skin	MSW = Scribe	VSDB = Vanity Sink Drawer Base
BSPICE = Base Spice Pull Out (no filler)	MWC = Microwave Cabinet	W = Wall
BWB = Base Waste Basket	OC = Oven Cabinet	WC = Wall Corner
CCROWN = Cove Crown	ORG = Organizer	WDC = Wall Diagonal Cabinet
CORBEL = Corbel	P = Panel	WEC = Wall End Cabinet
DB_D2 = Drawer Base, 2 Drawers	POS = Pull-out Shelf	WER = Wall Easy Reach
DB_D3 = Drawer Base, 3 Drawers	POSSC = Pull-out Shelf - Soft Close	WF = Wall Filler
DB_D4 = Drawer Base, 4 Drawers	PR = Plate Rack	WMC = Wall Medicine Cabinet
DD = Double Door	REFP = Refrigerator Panel	WMD = Wall Mullion Door (Door Prepped for Glass)
DEP = Decorative End Panel	REVCROWN = Reversible Crown	WMDC = Wall Mullion Diagonal Cabinet (Door Prepped for Glass)
DWEP = Decorative Wall End Panel	ROINSTKIT = Roll-out Install Kit	WSPICE = Base Spice Pull Out (no filler)
DWP = Dishwasher End Panel	RW = Refrigerator Wall	WR = Wine Rack
F = Filler	SB = Sink Base	WSKIN = Wall Skin
FB = Furniture Base	SCB = Sink Corner Base	
FF = Fluted Filler	SCBFF = Sink Corner Base w/Front & Floor	
FSB = Farm Sink Base	SER = Susan Easy Reach	
FSHELF = Floating Shelf	SGH = Stem Glass Holder	
FWF = Fluted Wall Filler	SLGCROWN = Large Crown for Full Overlay	B12 = Base 12" Wide
	SMCROWN = Small Crown	W3030 = Wall 30" Wide, 30" High
	SS = Super Lazy Susan	
	SSMCROWN = Small Crown for Full Overlay	

Depth Modifications

• Modifications are available on stock cabinets only

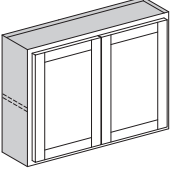
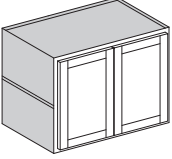
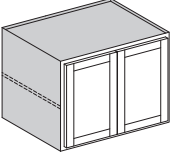
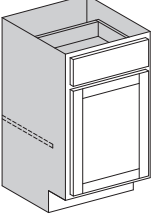
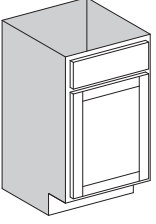
		MODIFICATION CODE	AVAILABILITY
REDUCE WALL DEPTH			
	<ul style="list-style-type: none"> • Reduces standard wall, wall corner, mullion door and book case cabinets to 9" or 6" depths • Diagonal, Easy Reach, Plate, Wine and Microwave wall cabinets can not be reduced • Shelves are reduced with the cabinet • Storage solution inserts not available when cabinet is reduced 	RW_	✓
INCREASE WALL DEPTH			
	<ul style="list-style-type: none"> • Increase standard wall cabinets to 15", 18", 21" or 24" depths • Mullion Door, Diagonal, Easy Reach, Plate, Wine, Microwave and Medicine wall cabinets can not be increased • Shelves are increased with cabinets when applicable • Storage solution inserts not available when cabinet is increased 	IWD_	✓
REDUCE REFRIGERATOR WALL DEPTH			
	<ul style="list-style-type: none"> • Reduces refrigerator wall cabinets to 21", 18", 15", 12", 9" or 6" depths • Storage solution inserts not available • Shelves are reduced with cabinets when applicable 	RRW_	✓
REDUCE BASE DEPTH			
	<ul style="list-style-type: none"> • Reduces standard base and base corner (blind) to 21", 18", 15" or 12" depths • Reduce vanity base cabinets to 18", 15" or 12" depths • Diagonal, Easy Reach and Base End cabinets can not be reduced • Drawer Box and glides are reduced • Shelf is not reduced • Storage solution inserts not available when reduced • Door Mounted items are allowed; shelf will be removed at 12" depth • Reduce depth Pull-out shelves not available with 12" depth reduction 	RB_	✓
REDUCE SINK BASE DEPTH			
	<ul style="list-style-type: none"> • Reduces sink base cabinets to 21", 18", 15" and 12" depths • Reduces vanity sink base cabinets with no drawers to 18", 15" and 12" depths • Storage solution inserts and pull-out shelving not available when reduced • Tip-out Trays and Door Mounted items are allowed 	RSB_	✓

Depth Modifications

• Modifications are available on stock cabinets only

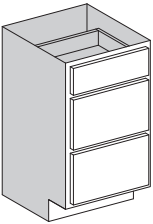
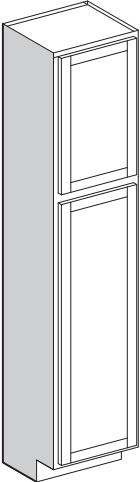
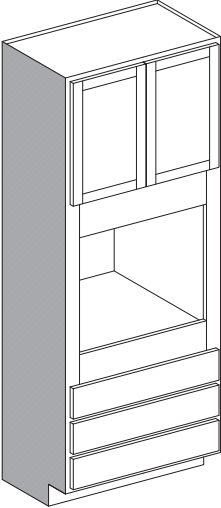
		MODIFICATION CODE	AVAILABILITY
REDUCE DRAWER BASE DEPTH			
	<ul style="list-style-type: none"> • Reduces standard drawer base to 21", 18", 15" or 12" depths • Reduces vanity sink base cabinets with drawers to 18", 15" or 12" depths • Storage solution inserts not available when reduced 	RDB_	✓
REDUCE TALL DEPTH			
	<ul style="list-style-type: none"> • Reduces standard tall cabinets to 21", 18", 15" or 12" depths • Reduces linen cabinets to 18", 15" or 12" depths • Reduce depth Pull-out shelves not available with 12" depth reduction • Reduce depth shelves and shelf kits available 	RT_	✓
REDUCE OVEN DEPTH			
	<ul style="list-style-type: none"> • Reduces oven cabinets to 21", 18", 15" or 12" depths • Cabinet and drawers are reduced • Oven shelf OC3324 can not be reduced; field-cut required 	RO_	✓

Toekick Modifications

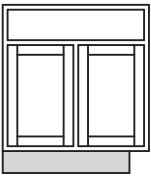
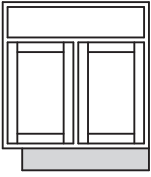
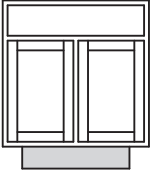
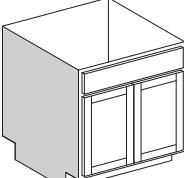
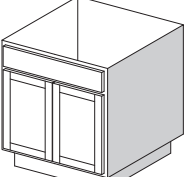
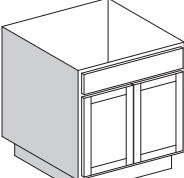
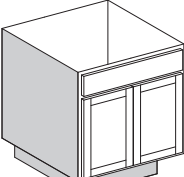
<ul style="list-style-type: none"> • Modifications are available on stock cabinets only • Wall cabinets require the Add Toekick (ATK) modification before any other toekick modifications can be preformed 		MODIFICATION CODE	AVAILABILITY
RECESS TOEKICK - RIGHT			
	<ul style="list-style-type: none"> • Recess toekick on right side of base, vanity, tall and wall cabinets with added toekick • Toekick material does not match finish and requires a toekick cover when cabinet is installed 	RTR	✓
RECESS TOEKICK - LEFT			
	<ul style="list-style-type: none"> • Recess toekick on left side of base, vanity, tall and wall cabinets with added toekick • Toekick material does not match finish and requires a toekick cover when cabinet is installed 	RTL	✓
RECESS TOEKICK - BOTH			
	<ul style="list-style-type: none"> • Recess toekick on both sides of base, vanity, tall and wall cabinets with added toekick • Toekick material does not match finish and requires a toekick cover when cabinet is installed 	RTB	✓
RECESS TOEKICK - PENINSULA			
	<ul style="list-style-type: none"> • Recess toekick on back side of base, vanity, tall and wall cabinets with added toekick • Used for island or peninsula cabinets • Toekick material does not match finish and requires a toekick cover when cabinet is installed 	RTP	✓
RECESS TOEKICK - RIGHT AND PENINSULA			
	<ul style="list-style-type: none"> • Recess toekick on right and back sides of base, vanity, tall and wall cabinets with added toekick • Used for island or end of peninsula cabinets • Toekick material does not match finish and requires a toekick cover when cabinet is installed 	RTRP	✓
RECESS TOEKICK - LEFT AND PENINSULA			
	<ul style="list-style-type: none"> • Recess toekick on left and back sides of base, vanity, tall and wall cabinets with added toekick • Used for island or end of peninsula cabinets • Toekick material does not match finish and requires a toekick cover when cabinet is installed 	RTLTP	✓
RECESS TOEKICK - BOTH AND PENINSULA			
	<ul style="list-style-type: none"> • Recess toekick on right, left and back sides of base, vanity, tall and wall cabinets with added toekick • Used for island or end of peninsula cabinets • Not available on super susans, diagonal or easy-reach cabinets • Toekick material does not match finish and requires a toekick cover when cabinet is installed 	RTBP	✓

Toekick Modifications

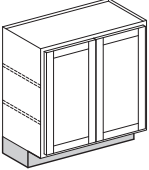
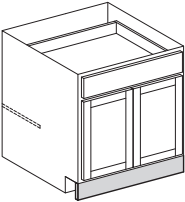
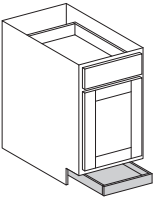
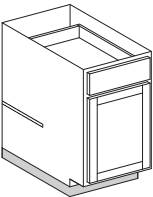
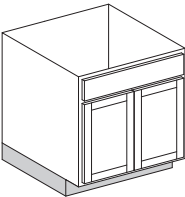
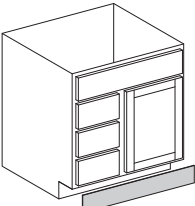
<ul style="list-style-type: none"> • Modifications are available on stock cabinets only • Wall cabinets require the Add Toekick (ATK) modification before any other toekick modifications can be performed 	MODIFICATION CODE	AVAILABILITY
ADD TOEKICK TO WALL CABINET		
 <p>See Note</p>	<ul style="list-style-type: none"> • Adds a standard height toekick (4 1/2" high) to standard, refrigerator and mullion door wall cabinets • Not available on 42" high wall cabinets • Toekick does not match finish and requires toekick cover when installed • Diagonal, Easy Reach, Plate, Wine, Microwave and Medicine wall cabinets can not receive toekick addition • NOTE: Toekick will have a visible seam on side of cabinet. A wall skin or flush end modification is required when cabinet is at end of cabinet run or a decorative end is applied 	<p>ATK</p> <p>✓</p>
FLUSH TOEKICK		
 <p>See Note</p>	<ul style="list-style-type: none"> • Adds matching filler to front of base, vanity, tall or wall cabinet with added toekick • Flush toekick ends will not be finished • Not available on super susans, diagonal or easy reach cabinets • NOTE: Toekick notch is visible on side of cabinet. A wall skin or flush end modification is required when cabinet is at end of cabinet run or a decorative end is applied 	<p>FTK</p> <p>✓</p>
TOEKICK DRAWER		
	<ul style="list-style-type: none"> • Adds toekick drawer to base, sink base and drawer base cabinets • Toekick drawers can be added to cabinet widths of 18" to 30" • Available on 24" deep cabinets only • Includes Soft Close undermount glides • Drawer box height is 3" • Matching toekick cover required - field trimmed/installed • 1" clearance from bottom of drawer box to bottom of cabinet • Unable to be used where obstacles protrude in front of drawer • No other toekick modifications can be applied with toekick drawer 	<p>ATD</p> <p>✓</p>
CHANGE TOEKICK HEIGHT		
	<ul style="list-style-type: none"> • Changes toekick height by removing 2" or 3" from original toekick • Not available on super susans, diagonal or easy reach cabinets • CTH2 overall cabinet height = 32 1/2" • CTH3 overall cabinet height = 31 1/2" • Can not be used as ADA cabinetry due to reduced toekick height 	<p>CTH_</p> <p>✓</p>
REMOVE TOEKICK		
	<ul style="list-style-type: none"> • Removes toekick from base, vanity and tall cabinets • Not available on super susans, diagonal or easy reach cabinets • Cabinet height with toekick removed is 30" high • Not designed for wall mounted cabinets 	<p>RMT</p> <p>✓</p>
INSTALL TOEKICK COVER		
	<ul style="list-style-type: none"> • Installs 1/8" thick matching toekick cover on stand alone base, vanity, and tall cabinets • Available on cabinets with 4 1/2" high toekick • Not intended for multiple cabinets installed together due to gaps between toekick covers due to cabinet reveals 	<p>ITKC</p> <p>✓</p>

Frame Modifications

• Modifications are available on stock cabinets only

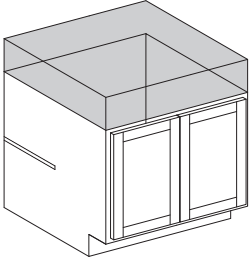
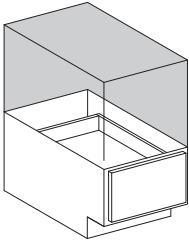
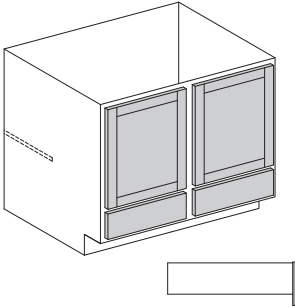
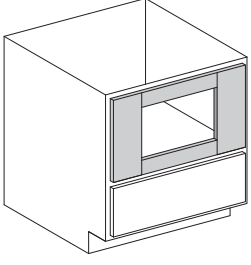
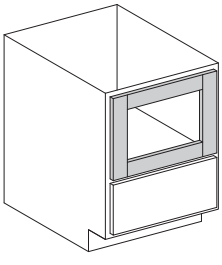
		MODIFICATION CODE	AVAILABILITY
APPLIANCE TOP PREP			
 <ul style="list-style-type: none"> • Removes entire top drawer area of base, drawer base, base corner, sink base and base waste basket cabinets • Can be used with cooktop, ranges and farm sinks • Cabinet height is 27³/₄" when modified • Drawer bases can be used to create desk height cabinets • Top of cabinet is open and unfinished where modified 		ATP	✓
APPLIANCE TOP PREP TWO DRAWERS			
 <ul style="list-style-type: none"> • Removes entire top two drawer areas of drawer base cabinets • Cabinet height is 16¹/₄" when modified • Can be used to create window and bench seats • Top of cabinet is open and unfinished where modified 		ATP2	✓
INVERTED FRAME			
 <ul style="list-style-type: none"> • Inverts frame on standard base, sink base, vanity base and vanity sink cabinets • Diagonal, easy-reach cabinets can not be modified • Tall cabinets can not be modified • Can be used to create vanity sink bases with additional storage; • Storage solution inserts not available when inverted • NOTE: Door and drawer front alignment will not match adjacent cabinets; recommended for stand alone applications <p>Drawer front is relocated on drawer box to align with adjacent cabinets; Drawer box may be seen when opening the door</p>		IF	✓
MICROWAVE OVERLAY			
 <ul style="list-style-type: none"> • Applies a trimmable overlay panel onto a BMW30's face frame • Can be easily removed (screws) for trimming • Overlay has 3" top and bottom and 6" sides • Overlay aligns with top of drawer with adjacent cabinet • Minimum Opening with Overlay = 17¹/₂" wide x 11¹/₈" tall • Maximum Opening without Overlay = 27" wide x 16" tall 		MOVL	✓
MICROWAVE DRAWER CONVERSION			
 <ul style="list-style-type: none"> • Converts a drawer base 24" wide (DB24D3) into a microwave cabinet with overlay panel • Can be easily removed (screws) for trimming • Overlay is 3" wide all around • Overlay aligns with top of drawer with adjacent cabinet • Used with countertop style microwaves • Minimum Opening with Overlay = 17¹/₂" wide x 10⁷/₈" tall • Maximum Opening without Overlay and Side Frame Trimmed 1/2" = 22¹/₄" wide x 16¹/₈" tall 		MDR	✓

Frame and Shelf Modifications

• Modifications are available on stock cabinets only

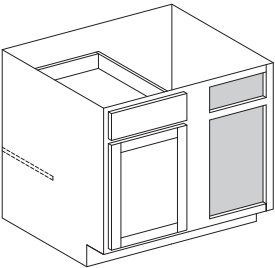
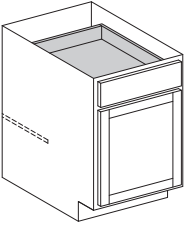
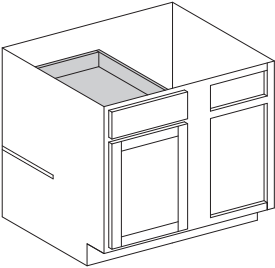
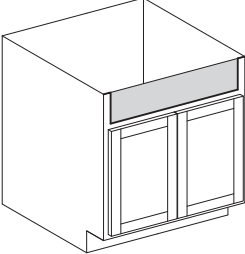
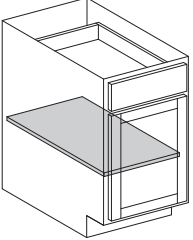
		MODIFICATION CODE	AVAILABILITY
CLOSE BLIND AREA OF BASE CORNER (BLIND)			
 <p>Close Blind Right Corner shown in illustration</p>	<ul style="list-style-type: none"> • Applies a cover over blind side of cabinet to base corner (blind) and wall corner cabinets • Must specify left or right (L/R) side to be covered • Helps to keep dust from entering cabinet and objects from falling into unreachable areas 	CBCL	✓
		CBCR	✓
REMOVE TOP DRAWER BOX			
	<ul style="list-style-type: none"> • Removes top drawer box and glides of base cabinets to create additional sink base cabinet sizes • Additional sink bases depths can be obtained by combining reduce sink base modification • Drawer fronts(s) will receive roller ball and spring clip mechanism for easy removal 	RTD	✓
REMOVE TOP DRAWER BOX - BLIND CORNER			
 <p>Remove Top Drawer Left shown in illustration</p>	<ul style="list-style-type: none"> • Removes top drawer box and glides of base corner (blind) cabinets • Drawer front will receive roller ball and spring clip mechanism for easy removal • Must specify left or right (L/R) side to be remove drawer box and receive mechanism for easy removal 	RTDL	✓
		RTDR	✓
FARM SINK PREP			
	<ul style="list-style-type: none"> • Adds a solid wood panel to farm sink opening • Panel is pocket-screwed for easy removal • Allows for smaller or unique shaped farm sinks 	FSP	✓
FULL DEPTH SHELF			
	<ul style="list-style-type: none"> • Adds a full depth adjustable shelf in place of the half-depth shelf to base cabinets • Storage solution inserts not available with full depth shelf • Not available on diagonal or easy reach cabinets • Available in cabinets 15" wide or greater 	FDS	✓

End Modifications

• Modifications are available on stock cabinets only

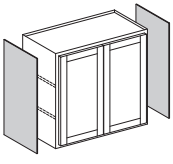
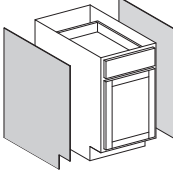
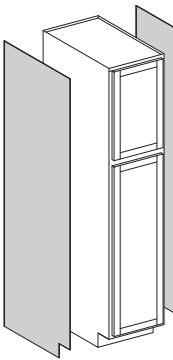
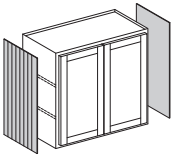
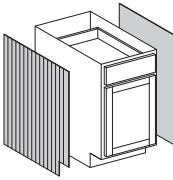
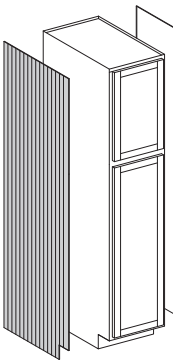



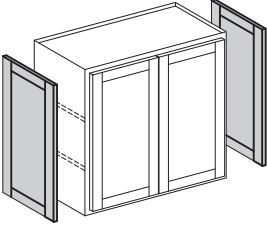
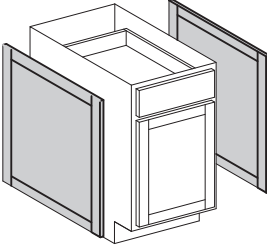
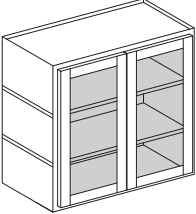
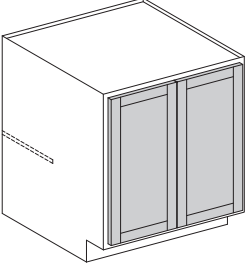
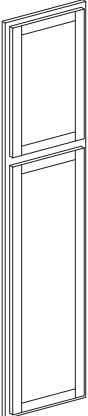

		MODIFICATION CODE	AVAILABILITY
FLUSH END			
	<ul style="list-style-type: none"> • Adds a flat panel(s) to side of wall cabinet to create a flush end appearance • Panel is mounted behind face frame and will have a visible seam • FWR = Flush end on right side of cabinet • FWL = Flush end on left side of cabinet • FWB = Flush end on both sides of cabinet 	FWR	✓
		FWL	✓
		FWB	✓
	<ul style="list-style-type: none"> • Adds a flat panel(s) to side of base or vanity cabinets to create a flush end appearance • Panel is mounted behind face frame and will have a visible seam • FBR = Flush end on right side of cabinet • FBL = Flush end on left side of cabinet • FBB = Flush end on both sides of cabinet 	FBR	✓
		FBL	✓
		FBB	✓
	<ul style="list-style-type: none"> • Adds a flat panel(s) to side of tall and linen cabinets to create a flush end appearance • Panel is mounted behind face frame and will have a visible seam • FTR = Flush end on right side of cabinet • FTL = Flush end on left side of cabinet • FTB = Flush end on both sides of cabinet 	FTR	✓
		FTL	✓
		FTB	✓
BEADED END			
	<ul style="list-style-type: none"> • Adds a beaded flat panel(s) to side of wall cabinet • Panel is mounted behind face frame and will have a visible seam • Beaded panel is positioned on cabinet side to create an consistent bead spacing appearance; spacing may not align with base cabinet below • BWR = Beaded end on right side of cabinet • BWL = Beaded end on left side of cabinet • BWB = Beaded end on both sides of cabinet 	BWR	✓
		BWL	✓
		BWB	✓
	<ul style="list-style-type: none"> • Adds a beaded flat panel(s) to side of base cabinet • Panel is mounted behind face frame and will have a visible seam • Beaded panel is positioned on cabinet side to create an consistent bead spacing appearance; spacing may not align with wall cabinet above • BBR = Beaded end on right side of cabinet • BBL = Beaded end on left side of cabinet • BBB = Beaded end on both sides of cabinet 	BBR	✓
		BBL	✓
		BBB	✓
	<ul style="list-style-type: none"> • Adds a beaded flat panel(s) to side of tall cabinet • Panel is mounted behind face frame and will have a visible seam • Beaded panel is positioned on cabinet side to create an consistent bead spacing appearance • BTR = Beaded end on right side of cabinet • BTL = Beaded end on left side of cabinet • BTB = Beaded end on both sides of cabinet 	BTR	✓
		BTL	✓
		BTB	✓

End and Door Modifications

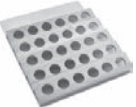





• Modifications are available on stock cabinets only

		MODIFICATION CODE	AVAILABILITY
DECORATIVE END			
 <ul style="list-style-type: none"> • Adds a decorative panel(s) to side of 30", 36" and 42" high wall cabinets • Decorative panel aligns with front doors • DWR = Decorative end on right side of wall cabinet • DWL = Decorative end on left side of wall cabinet • DWB = Decorative end on both sides of wall cabinet • Not available on wall end cabinets • Flush end required when adding decorative end panel to a wall cabinet with added toekick 		DWR	✓
		DWL	✓
		DWB	✓
 <ul style="list-style-type: none"> • Adds a decorative panel(s) to side of base, dishwasher end panel, or vanity cabinet • Decorative panel aligns with front doors and does not cover toekick area • DBR = Decorative end on right side of base cabinet • DBL = Decorative end on left side of base cabinet • DBB = Decorative end on both sides of base cabinet 		DBR	✓
		DBL	✓
		DBB	✓
DOOR FRAME PREPPED FOR GLASS			
 <ul style="list-style-type: none"> • Removes the center panel and provides a routed ledge to install glass • Available on wall cabinets, medicine wall cabinets and top door(s) of tall cabinets • Not available on tall linen cabinets • Glass and glass clips not included • Charge is PER DOOR • Two door cabinets must receive prep for glass on both doors • Cabinets Prepped for Glass can not have a door mounted item or a wall cabinet Insert • Routed ledge will not be finished. • Modification does not include matching interior added to cabinet. • NOTE: Waverly is not available for DF1 modification 		DF1	✓
FULL HEIGHT DOOR			
 <ul style="list-style-type: none"> • Converts a standard base and vanity cabinets into full height door cabinets using a 30" high wall cabinet face frame and door • List price will include a base and wall cabinet plus modification cost • Diagonal and easy-reach cabinets can not be modified • Includes one half-depth shelf • Drawer box and glides are removed • Classic offers full height door cabinetry in the Special Order section • NOTE: Door and drawer front alignment will not match adjacent cabinets; recommended for stand alone applications 		FHD	✓
FACE FRAME AND DOOR			
 <ul style="list-style-type: none"> • Provides the face frame and door(s) of wall, base, vanity and tall cabinets • Can not have any other modifications or cabinet Inserts 		FFD	✓

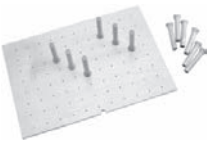





Installed Drawer Inserts

		MODIFICATION CODE	AVAILABILITY
INSTALLED SPICE DRAWER INSERT			
 <ul style="list-style-type: none"> • Spice storage installed into top drawer of base cabinets • 18" wide cabinets use B18SPICEI • 24" wide cabinets use B24SPICEI • 27", 30", 33" and 36" wide cabinets use B2736SPICEI • Available in 24" deep cabinets only • See Storage Solution section for accessory details 	B18SPICEI	✓	
	B24SPICEI	✓	
	B2736SPICEI	✓	
INSTALLED K-CUP DRAWER ORGANIZER			
 <ul style="list-style-type: none"> • K-Cup storage installed into top drawer of base cabinets • 18" wide cabinets use B18KCUPI • 24" wide cabinets use B24KCUPI • Available in 24" deep cabinets only • See Storage Solution section for accessory details 	B18KCUPI	✓	
	B24KCUPI	✓	
INSTALLED DRAWER CUTLERY TRAY			
 <ul style="list-style-type: none"> • Cutlery Tray storage installed into top drawer of base cabinets • 15" and 18" wide cabinets use B1518CUTI • 21" and 24" wide cabinets use B2124CUTI • Available in 24" deep cabinets only • See Storage Solution section for accessory details 	B1518CUTI	✓	
	B2124CUTI	✓	
 <ul style="list-style-type: none"> • Cutlery Tray storage installed into top drawer of base cabinets • 30", 33" and 36" wide cabinets use B3036CUTI • Available in 24" deep cabinets only • See Storage Solution section for accessory details 	B3036CUTI	✓	
INSTALLED KNIFE BLOCK INSERT			
 <ul style="list-style-type: none"> • Knife storage installed into top drawer of base cabinets • 15", 18" and 21" wide cabinets use B1521KNI • Available in 24" deep cabinets only • See Storage Solution section for accessory details 	B1521KNI	✓	
 <ul style="list-style-type: none"> • Knife storage installed into top drawer of base cabinets • 30", 33" and 36" wide cabinets use B3036KNI • Available in 24" deep cabinets only • See Storage Solution section for accessory details 	B3036KNI	✓	
INSTALLED BASE UTILITY DRAWER			
 <ul style="list-style-type: none"> • Utility Tray storage installed into top drawer of base cabinets • 27", 30", 33" and 36" wide cabinets use B2736UTI • Available in 24" deep cabinets only • See Storage Solution section for accessory details 	B2736UTI	✓	









Installed Drawer and Door Storage

		MODIFICATION CODE	AVAILABILITY
INSTALLED PEG ORGANIZATION SYSTEM			
 <ul style="list-style-type: none"> • Peg organization installed in deep drawers • Available in drawer base and microwave (BMW30) cabinets • Installed in bottom drawers • DB30PEGI includes (12) push-in pegs • DB36PEGI includes (16) push-in pegs • See Storage Solution section for accessory details 	DB30PEGI	✓	
	DB36PEGI	✓	
INSTALLED CUTTING BOARD			
 <ul style="list-style-type: none"> • Cutting Board installed onto door of base cabinets • 15" wide cabinets use B15DMCBI • 18" wide cabinets use B18DMCBI • Can not be used in combination with any other insert • See Storage Solution section for accessory details 	B15DMCBI	✓	
	B18DMCBI	✓	
INSTALLED DOOR STORAGE			
 <ul style="list-style-type: none"> • Door mounted storage installed in sink base cabinets • See Storage Solution section for accessory details • SB30 and SB33 cabinets use SB3033DSTI • SB36 uses SB36DSTI • SB42 uses SB42DSTI 	SB3033DSTI	✓	
	SB36DSTI	✓	
	SB42DSTI	✓	
INSTALLED APPLIANCE STORAGE RACK			
 <ul style="list-style-type: none"> • Door mounted storage for 30" wide vanity sink base cabinet • Used to store various bathroom items • (2) 1 1/4" quart stainless steel bins • See Storage Solution section for accessory details 	VSB30ASTI	✓	
INSTALLED DOOR MOUNTED WASTE BIN			
 <ul style="list-style-type: none"> • Door mounted waste container for 30" wide vanity sink base cabinet • Includes one silver, 8-quart waste bin • See Storage Solution section for accessory details 	VSB30DWBI	✓	
INSTALLED SINK BASE TIP-OUT TRAY			
 <ul style="list-style-type: none"> • Tip-out Trays installed into a sink base cabinet • 27", 30", 33" and 36" wide cabinets use SB2736TIPOUTI • 39" and 42" wide cabinets use SB3942TIPOUTI • See Storage Solution section for accessory details 	SB2736TIPOUTI	✓	
	SB3942TIPOUTI	✓	

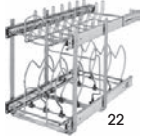
Installed Storage Solutions

		MODIFICATION CODE	AVAILABILITY
INSTALLED SINK BASE STAINLESS STEEL, SOFT CLOSE TIP-OUT TRAY			
 <ul style="list-style-type: none"> Stainless steel Tip-out Trays with Soft Close installed into a 30" wide sink base cabinet 30" wide cabinets use SB30TIPOUTSSI 33" wide cabinets use SB33TIPOUTSSI 36" wide cabinets use SB36TIPOUTSSI See Storage Solution section for accessory details 	SB30TIPOUTSSI	✓	
	SB33TIPOUTSSI	✓	
	SB36TIPOUTSSI	✓	
INSTALLED SINK BASE DRIP TRAY			
 <ul style="list-style-type: none"> Drip Trays installed into a sink base 27" and 30" wide cabinets use SB2730DRIP 33" and 36" wide cabinets use SB3336DRIP 39" and 42" wide cabinets use SB3942DRIP Not available in vanity sink base cabinets See Storage Solution section for accessory details 	SB2730DRIP	✓	
	SB3336DRIP	✓	
	SB3942DRIP	✓	
INSTALLED WALL DIAGONAL LAZY SUSAN			
<p>20 Diameter</p>  <ul style="list-style-type: none"> Lazy Susan installed into a 30", 36" or 42" high diagonal wall cabinet One or two Lazy Susan's can be installed Lazy Susan will be installed on bottom of cabinet The second Lazy Susan will be installed on next shelf up Charge is per Lazy Susan See Storage Solution section for accessory details 	WDC24LS_I	✓	
INSTALLED LAZY SUSAN UPGRADE			
 <ul style="list-style-type: none"> Installs wood lazy susan into Base Super Susan cabinet (SS36) Two trays each 28" diameter 5/8" thick maple independently operated revolving trays Trays have a 2" high banded wood rim See Storage Solution section for accessory details 	SS36LSUI	✓	
INSTALLED WALL ORGANIZER PULL-OUT			
 <p>26 1/16</p> <p>10 3/4</p> <ul style="list-style-type: none"> Organizer pull-out installed into a 30", 36" or 42" high wall cabinet For a 9" wide wall cabinet use W09POI For a 12" wide wall cabinet use W12POI Top shelf will have chrome rails for storage in 36" and 42" high cabinets See Storage Solution section for accessory details 	W09POI	✓	
	W12POI	✓	
INSTALLED BASE FULL HEIGHT ORGANIZER PULL-OUT			
 <p>25 1/2</p> <p>22 1/2</p> <ul style="list-style-type: none"> Full Height Organizer Pull-out installed into a B09FH Pull-out is door mounted, hinge holes on back of door are visible when opened See Storage Solution section for details on accessory 	B09POI	✓	

Installed Storage Solutions

		MODIFICATION CODE	AVAILABILITY
INSTALLED BASE FULL HEIGHT UTENSIL ORGANIZER PULL-OUT			
 <p>25 1/2 22 1/2</p>	<ul style="list-style-type: none"> • Full Height Utensil Organizer Pull-out installed into a B09FH • Pull-out is door mounted, hinge holes on back of door are visible when opened • See Storage Solution section for details on accessory 	B09POUTI	✓
INSTALLED BASE ORGANIZER PULL-OUT			
 <p>19 1/2 21 5/8</p>	<ul style="list-style-type: none"> • Full Height Organizer Pull-out installed into a B15 • Pull-out is door mounted, hinge holes on back of door are visible when opened • See Storage Solution section for details on accessory 	B15POI	✓
INSTALLED POTS AND PANS ORGANIZER			
 <p>18 22</p>	<ul style="list-style-type: none"> • Pots and Pans Two-Tier Organizer installed into a base cabinet • 15" wide cabinets use B15PPORGI • 24" wide cabinets use B24PPORGI • See Storage Solution section for details on accessory 	B15PPORGI	✓
		B24PPORGI	✓
INSTALLED BASE STORAGE ORGANIZER			
 <p>18 21 1/2</p>	<ul style="list-style-type: none"> • Base Storage Organizer with Soft Close installed into a B18 • Organizer is pulled out after opening the door • See Storage Solution section for details on accessory 	B18ORGI	✓
		B24ORGI	✓
INSTALLED TIERED COOKWARE ORGANIZER			
	<ul style="list-style-type: none"> • Two-tiered cookware organizer installed into B18 or B24 cabinets • Organizer is pulled out after opening the door • Soft Close glides • See Storage Solution section for details on accessory 	B18CWORGI	✓
		B24CWORGI	✓
INSTALLED BASE WASTEBASKET			
 <p>19 1/2 21 3/4</p>	<ul style="list-style-type: none"> • Base Wastebasket with Soft Close installed into a B15 • Holds one 35 quart wastebasket • Wastebasket is door mounted, hinge holes on back of door are visible when opened • See Storage Solution section for details on accessory 	B15WBI	✓
 <p>19 1/2 21 3/4</p>	<ul style="list-style-type: none"> • Base Wastebasket with Soft Close installed into a B18 • Holds two 35 quart wastebaskets • Wastebasket is door mounted, hinge holes on back of door are visible when opened • See Storage Solution section for details on accessory 	B18WBI	✓
 <p>19 1/2 21 3/4</p>	<ul style="list-style-type: none"> • Base Wastebasket with Soft Close installed into a B21 • Holds two 35 quart wastebaskets • Wastebasket is door mounted, hinge holes on back of door are visible when opened • See Storage Solution section for details on accessory 	B21WBI	✓

Installed Soft Close Pull-out Shelves

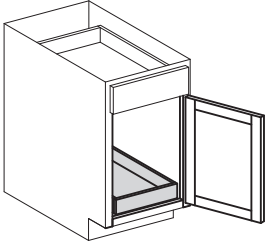
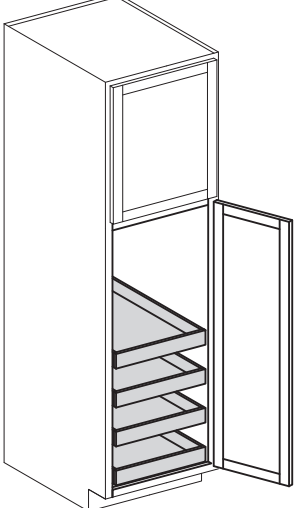
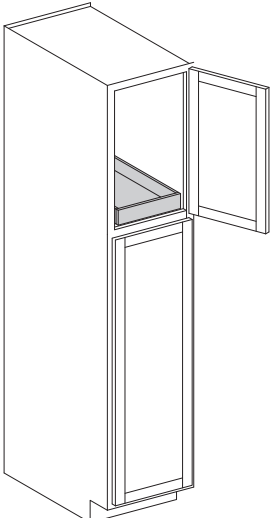
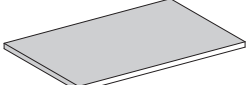
		MODIFICATION CODE	AVAILABILITY	
INSTALLED SOFT CLOSE, UNDERMOUNT PULL-OUT SHELVES				
 <ul style="list-style-type: none"> • Installs pull-out shelves with Soft Close shelves into base and tall cabinets • Base cabinets can receive one or two pull-out shelves • Base cabinets with single pull-out shelves will be bottom-mounted • Base cabinets with double pull-out shelves will be bottom and mid-mounted • Tall cabinets can receive one, two, three or four pull-out shelves • Tall cabinets with single pull-out shelves will be bottom-mounted, additional pull-out shelves will be equally spaced vertically • Pull-out shelves with Soft Close will have undermount glides • Pull-out shelves with Soft Close are installed with pull-out install kits to allow for easy adjustability • Storage solution inserts can not be added into lower opening • Not available on diagonal or easy reach cabinets • Half-depth shelves in base cabinets will not be included <p>POSSC (Pull-Out Shelf, Soft Close) 18 (width) 4 (quantity) I (installed identifier)</p> 		POSSC12_I	✓	
			POSSC15_I	✓
			POSSC18_I	✓
			POSSC21_I	✓
			POSSC24_I	✓
			POSSC27_I	✓
			POSSC30_I	✓
			POSSC33_I	✓
			POSSC36_I	✓
 <ul style="list-style-type: none"> • Installs a single pull-out shelf with Soft Close into top section of tall cabinets • Top section of tall cabinet will receive one pull-out shelf in bottom position • Pull-out shelf will be installed with pull-out install kit for easy adjustability and ability to add more pull-out shelves • Additional pull-out shelves sold separately and are field installed 		POSSC18T	✓	
			POSSC24T	✓
REDUCE SHELF DEPTH				
 <ul style="list-style-type: none"> • Reduces 18" and 24" wide shelves (U1824SHELF, U2424SHELF) or shelf kits (1824SHELFK, U2424SHELFK) to 21", 18", 15" or 12" depths • Reduces 15" wide shelves (LC1521) to 18", 15" or 12" depths • Can be used in reduced tall and linen cabinets or increased wall cabinets 		RS18_	✓	
			RS24_	✓
			RSK18_	✓
			RSK24_	✓

Reduced/Reduced and Installed Soft Close Pull-out Shelves

INSTALLED STORAGE SOLUTIONS

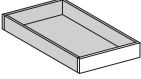
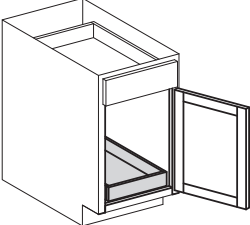
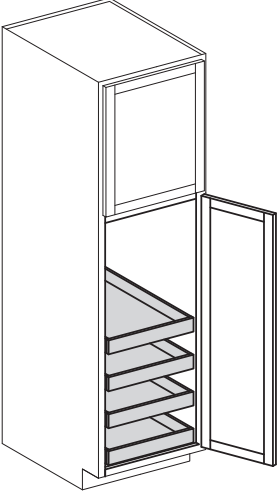
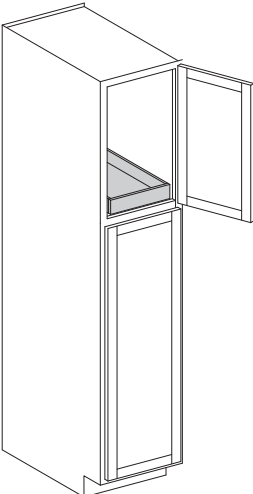
		MODIFICATION CODE	AVAILABILITY	
REDUCE DEPTH SOFT CLOSE PULL-OUT SHELF				
 <ul style="list-style-type: none"> Reduce depth, field installed pull-out shelves with Soft Close glides (POSSC) to 21", 18" or 15" depths 12" depth reductions are not available Pull-out shelves using epoxy side mount glides are not available for depth reduction modification <p>POSSC (Pull-Out Shelf, Soft Close) 18 (width) 21 (modified depth of POSSC)</p>		POSSC12_	✓	
			POSSC15_	✓
			POSSC18_	✓
			POSSC21_	✓
			POSSC24_	✓
			POSSC27_	✓
			POSSC30_	✓
			POSSC33_	✓
		POSSC36_	✓	
REDUCED AND INSTALLED SOFT CLOSE PULL-OUT SHELVES				
  <ul style="list-style-type: none"> Installs reduced pull-out shelves with Soft Close shelves into vanity and reduced base and tall cabinets Vanity and reduced base cabinets can receive one or two pull-out shelves Reduced tall cabinets can receive one, two, three or four pull-out shelves Base cabinets with single pull-out shelves will be bottom-mounted Base cabinets with double pull-out shelves will be bottom and mid-mounted Reduced tall cabinets can receive one, two, three or four pull-out shelves Tall cabinets with single pull-out shelves will be bottom-mounted, additional pull-out shelves will be equally spaced vertically Pull-out shelves with Soft Close will have undermount glides Pull-out shelves with Soft Close are installed with pull-out install kits to allow for easy adjustability Storage solution inserts can not be added into lower opening Not available on diagonal or easy reach cabinets Half-depth shelves in base cabinets will not be included <p>POSSC (Pull-Out Shelf, Soft Close) 12 (width) 15 (depth) 2 (quantity) 1 (installed identifier)</p>		POSSC12_ I	✓	
			POSSC15_ I	✓
			POSSC18_ I	✓
			POSSC21_ I	✓
			POSSC24_ I	✓
			POSSC27_ I	✓
			POSSC30_ I	✓
			POSSC33_ I	✓
		POSSC36_ I	✓	
 <ul style="list-style-type: none"> Installs a single pull-out shelf with Soft Close into top section of tall cabinets Top section of tall cabinet will receive one pull-out shelf in bottom position Pull-out shelf will be installed with pull-out install kit for easy adjustability and ability to add more pull-out shelves Additional pull-out shelves sold separately and are field installed 		POSSC18_T	✓	
			POSSC24_T	✓

Installed Epoxy Pull-out Shelves

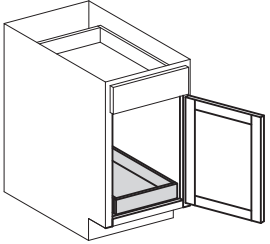
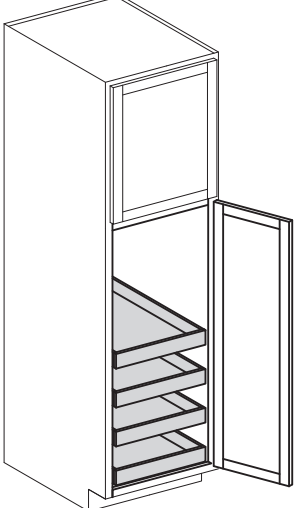
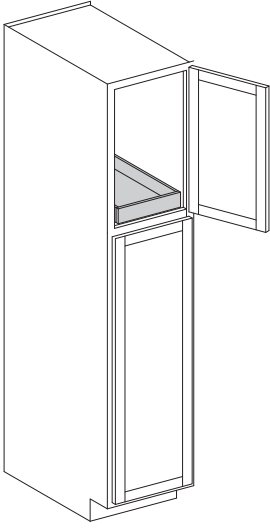
		MODIFICATION CODE	AVAILABILITY
INSTALLED EPOXY SIDEMOUNT PULL-OUT SHELVES			
 	<ul style="list-style-type: none"> • Installs pull-out shelves into base and tall cabinets • Base cabinets can receive one or two pull-out shelves • Base cabinets with single pull-out shelves will be bottom-mounted • Base cabinets with double pull-out shelves will be bottom and mid-mounted • Tall cabinets can receive one, two, three or four pull-out shelves • Tall cabinets with single pull-out shelves will be bottom-mounted, additional pull-out shelves will be equally spaced vertically • Pull-out shelves will have epoxy side mounted glides • Glides are not soft-closing • Pull-out shelves are installed with pull-out install kits to allow for easy adjustability • Storage solution inserts can not be added into lower opening • Not available on diagonal or easy reach cabinets • Half-depth shelves in base cabinets will not be included 	POS12_I	✓
		POS15_I	✓
		POS18_I	✓
		POS21_I	✓
		POS24_I	✓
		POS27_I	✓
		POS30_I	✓
		POS33_I	✓
		POS36_I	✓
	<ul style="list-style-type: none"> • Installs a single pull-out shelf with epoxy side mounted glides into top section of tall cabinets • Top section of tall cabinet will receive one pull-out shelf in bottom position • Pull-out shelf will be installed with pull-out install kit for easy adjustability and ability to add more pull-out shelves • Additional pull-out shelves sold separately and are field installed 	POS18T	✓
		POS24T	✓

Wall Cabinets – 12" Deep

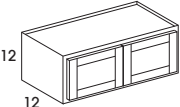
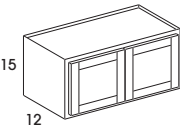
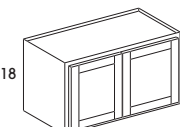
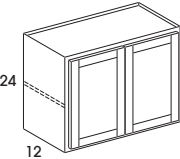
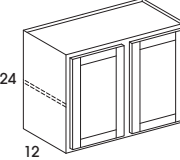
	SKU	cubes	STANDARD				COMPLEMENTS PAINT		
			Hanover	Dartmouth	Dartmouth 5-piece York Waverly	Berwyn	Hanover Complements Paint	Dartmouth Complements Paint	Dartmouth 5-piece York Waverly Complements Paint
WALL – 12" HIGH – 12" DEEP									
 <ul style="list-style-type: none"> • Two butt doors • Shelves not available • Available widths: 30"-36" 	W3012	3.0	✓	✓	✓	✓	✓	✓	✓
	W3312	3.0	✓	✓	✓	✓	✓	✓	✓
	W3612	3.0	✓	✓	✓	✓	✓	✓	✓
WALL – 15" HIGH – 12" DEEP									
 <ul style="list-style-type: none"> • Two butt doors • Shelves not available • Available widths: 24"-36" 	W2415DD	3.0	✓	✓	✓	✓	✓	✓	✓
	W3015	4.0	✓	✓	✓	✓	✓	✓	✓
	W3315	4.0	✓	✓	✓	✓	✓	✓	✓
	W3615	4.0	✓	✓	✓	✓	✓	✓	✓
WALL – 18" HIGH – 12" DEEP									
 <ul style="list-style-type: none"> • Two butt doors • Shelves not available • Available widths: 24"-36" 	W2418DD	5.0	✓	✓	✓	✓	✓	✓	✓
	W3018	5.0	✓	✓	✓	✓	✓	✓	✓
	W3318	5.0	✓	✓	✓	✓	✓	✓	✓
	W3618	5.0	✓	✓	✓	✓	✓	✓	✓
WALL – 24" HIGH – 12" DEEP									
 <ul style="list-style-type: none"> • Two butt doors • One adjustable shelf • Available widths: 24"-36" 	W2424DD	4.0	✓	✓	✓	✓	✓	✓	✓
	W2724	5.0	✓	✓	✓	✓	✓	✓	✓
	W3024	5.0	✓	✓	✓	✓	✓	✓	✓
	W3324	6.0	See Special Order Section	✓	✓	✓	See Special Order Section	✓	✓
	W3624	6.0	✓	✓	✓	✓	✓	✓	✓
 <ul style="list-style-type: none"> • Two doors, cabinet with center stile • One adjustable shelf • Available width: 39" 	W3924	7.0	✓	✓	✓	✓	✓	✓	

Wall Cabinets – 12" Deep

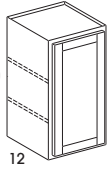
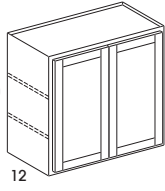
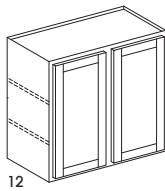
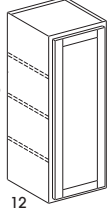
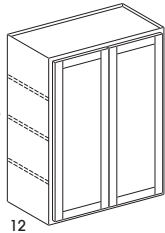
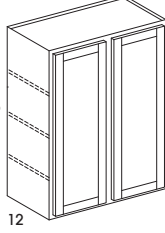
Design Tips: <ul style="list-style-type: none"> All single-door cabinets are hinged left Cabinets can be tipped during installation for right hinge applications 		SKU	cubes	STANDARD				COMPLEMENTS PAINT			
				Hanover	Dartmouth	Dartmouth 5-piece York Waverly	Berwyn	Hanover Complements Paint	Dartmouth Complements Paint	Dartmouth 5-piece York Waverly Complements Paint	
WALL – 30" HIGH – 12" DEEP											
	<ul style="list-style-type: none"> Single door Two adjustable shelves Available widths: 9"-21" 	W0930	2.0	✓	✓	✓	✓	✓	✓	✓	
		W1230	3.0	✓	✓	✓	✓	✓	✓	✓	
		W1530	4.0	✓	✓	✓	✓	✓	✓	✓	
		W1830	4.0	✓	✓	✓	✓	✓	✓	✓	
		W2130	5.0	✓	✓	✓	✓	✓	✓	✓	
	<ul style="list-style-type: none"> Two butt doors Two adjustable shelves Available widths: 24"-36" 	W2430DD	5.0	✓	✓	✓	✓	✓	✓		
		W2730	6.0	✓	✓	✓	✓	✓	✓		
		W3030	7.0	✓	✓	✓	✓	✓	✓		
		W3330	7.0	✓	✓	✓	✓	✓	✓		
		W3630	8.0	✓	✓	✓	✓	✓	✓		
	<ul style="list-style-type: none"> Two doors, cabinet with center stile Two adjustable shelves Available widths: 39" and 42" 	W3930	8.5	✓	✓	✓	✓	✓	✓		
		W4230	9.0	✓	✓	✓	✓	✓	✓		
WALL – 36" HIGH – 12" DEEP											
	<ul style="list-style-type: none"> Single door Three adjustable shelves Available widths: 9"-21" 	W0936	3.0	✓	✓	✓	✓	✓	✓		
		W1236	3.0	✓	✓	✓	✓	✓	✓		
		W1536	4.0	✓	✓	✓	✓	✓	✓		
		W1836	5.0	✓	✓	✓	✓	✓	✓		
		W2136	6.0	✓	✓	✓	✓	✓	✓		
	<ul style="list-style-type: none"> Two butt doors Three adjustable shelves Available widths: 24"-36" 	W2436DD	6.0	✓	✓	✓	✓	✓	✓		
		W2736	7.0	✓	✓	✓	✓	✓	✓		
		W3036	8.0	✓	✓	✓	✓	✓	✓		
		W3336	9.0	✓	✓	✓	✓	✓	✓		
		W3636	9.0	✓	✓	✓	✓	✓	✓		
	<ul style="list-style-type: none"> Two doors, cabinet with center stile Three adjustable shelves Available width: 42" 	W4236	11.0	✓	✓	✓	✓	✓	✓		

Wall Cabinets – 12" Deep

Design Tips:

- All single-door cabinets are hinged left
- Cabinets can be ipped during installation for right hinge applications

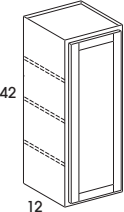
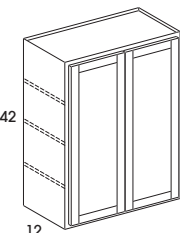
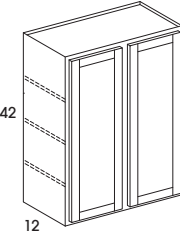
	SKU	cubes	STANDARD				COMPLEMENTS PAINT		
			Hanover	Dartmouth	Dartmouth 5-piece York Waverly	Berwyn	Hanover Complements Paint	Dartmouth Complements Paint	Dartmouth 5-piece York Waverly Complements Paint
WALL – 42" HIGH – 12" DEEP									
 <ul style="list-style-type: none"> • Single door • Three adjustable shelves • Available widths: 9"-21" 	W0942	3.0	✓	✓	✓	✓	✓	✓	✓
	W1242	4.0	✓	✓	✓	✓	✓	✓	✓
	W1542	5.0	✓	✓	✓	✓	✓	✓	✓
	W1842	6.0	✓	✓	✓	✓	✓	✓	✓
	W2142	7.0	✓	✓	✓	✓	✓	✓	✓
 <ul style="list-style-type: none"> • Two butt doors • Three adjustable shelves • Available widths: 24"-36" 	W2442DD	7.0	✓	✓	✓	✓	✓	✓	✓
	W2742	8.0	✓	✓	✓	✓	✓	✓	✓
	W3042	9.0	✓	✓	✓	✓	✓	✓	✓
	W3342	10.0	✓	✓	✓	✓	✓	✓	✓
	W3642	11.0	✓	✓	✓	✓	✓	✓	✓
 <ul style="list-style-type: none"> • Two doors, cabinet with center stile • Three adjustable shelves • Available width: 42" 	W4242	13.0	✓	✓	✓	✓	✓	✓	✓

Wall Cabinets – 12" and 24" Deep

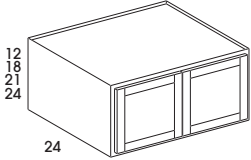
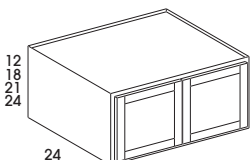
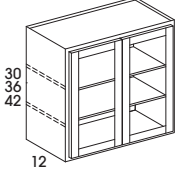
	SKU	cubes	STANDARD				COMPLEMENTS PAINT			
			Hanover	Dartmouth	Dartmouth 5-piece York Waverly	Berwyn	Hanover Complements Paint	Dartmouth Complements Paint	Dartmouth 5-piece York Waverly Complements Paint	
REFRIGERATOR WALL - 24" DEEP										
 <ul style="list-style-type: none"> • Two butt doors • Shelves not available in 12", 18", or 21" high • 24" high cabinets include one adjustable shelf • Available width: 33" 	RW3312	6.0	See Special Order Section	✓	✓	✓	See Special Order Section	✓	✓	
	RW3318	9.0	✓	✓	✓	✓	✓	✓		
	RW3321	10.0	See Special Order Section	✓	✓	✓	See Special Order Section	✓	✓	
	RW3324	12.0	✓	✓	✓	✓	✓	✓	✓	
 <ul style="list-style-type: none"> • Two butt doors • Shelves not available in 12", 18", or 21" high • 24" high cabinets include one adjustable shelf • Available width: 36" 	RW3612	6.0	✓	✓	✓	✓	✓	✓		
	RW3618	9.0	✓	✓	✓	✓	✓	✓		
	RW3621	10.0	See Special Order Section	✓	✓	✓	See Special Order Section	✓	✓	
	RW3624	12.0	✓	✓	✓	✓	✓	✓	✓	
WALL WITH DOORS PREPPED FOR GLASS - 12" DEEP										
 <ul style="list-style-type: none"> • Standard cabinets have matching interior and exterior, including top and bottom • Color Complements will have white interior and shelves. Top and bottom will match complement color • Two butt doors • 30" high - two adjustable shelves • 36" and 42" high - three adjustable shelves • 90° flat-front shelves are edge banded to match interior • Glass and glass clips are not included • Please order glass after receipt of product to ensure proper fit • Doors can receive up to 3/16" thick glass • Available widths: 30" and 36" • NOTE: Waverly Prepped for Glass not available 	WMD3030	7.0	See Special Order Section	✓	✓	✓	See Special Order Section	✓	✓	
	WMD3036	8.0	See Special Order Section	✓	✓	✓	See Special Order Section	✓	✓	
	WMD3042	9.0	See Special Order Section	✓	✓	✓	See Special Order Section	✓	✓	

Wall Cabinets – 12" Deep

Design Tips:

- All single-door cabinets are hinged left
- Cabinets can be flipped during installation for right hinge applications

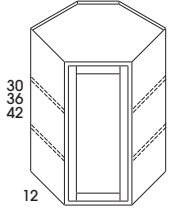
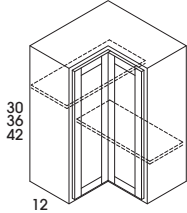
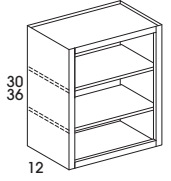
	SKU	cubes	STANDARD				COMPLEMENTS PAINT		
			Hanover	Dartmouth	Dartmouth 5-piece York Waverly	Berwyn	Hanover Complements Paint	Dartmouth Complements Paint	Dartmouth 5-piece York Waverly Complements Paint
DIAGONAL CORNER WALL – 12" DEEP									
 <ul style="list-style-type: none"> • Single door • 30" high - two adjustable shelves • 36" and 42" high - three adjustable shelves • Available width: 24" 	WDC2430	10.0	✓	✓	✓	✓	✓	✓	✓
	WDC2436	12.0	✓	✓	✓	✓	✓	✓	✓
	WDC2442	14.0	✓	✓	✓	✓	✓	✓	✓
WALL EASY REACH – 12" DEEP									
 <ul style="list-style-type: none"> • Bifold doors • 30" high - two rectangular adjustable shelves • 36" and 42" high - three rectangular adjustable shelves • Soft Close not available • Available width: 24" 	WER2430	10.0	✓	✓	✓	✓	✓	✓	✓
	WER2436	12.0	✓	✓	✓	✓	✓	✓	✓
	WER2442	14.0	✓	✓	✓	✓	✓	✓	✓
BOOKCASE CABINET – 30" HIGH – 12" DEEP									
 <ul style="list-style-type: none"> • No door • Matching Interior • 30" high - two adjustable shelves • 36" high - three adjustable shelves • Available widths: 18" and 24" 	BK1830	4.0	✓	✓	✓	✓	N/A	N/A	N/A
	BK2430	5.0	✓	✓	✓	✓	N/A	N/A	N/A

Wall Cabinets – 12" Deep

Design Tips: • All single-door cabinets are hinged left • Cabinets can be flipped during installation for right hinge applications	SKU	cubes	STANDARD				COMPLEMENTS PAINT		
			Hanover	Dartmouth	Dartmouth 5-piece York Waverly	Berwyn	Hanover Complements Paint	Dartmouth Complements Paint	Dartmouth 5-piece York Waverly Complements Paint

WALL CORNER – 12" DEEP

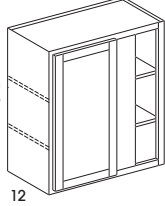
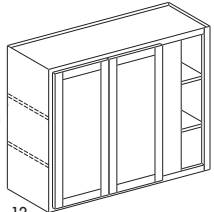
 <ul style="list-style-type: none"> • One door • Hinged left • 30" high - two adjustable shelves • 36" and 42" high - three adjustable shelves • Blind cabinets can be pulled 3" • Blind opening is 7" on all sizes • Does not include filler • Available widths: 24" and 30" 	WC2430	5.0	✓	✓	✓	✓	✓	✓	✓
	WC3030	7.0	✓	✓	✓	✓	✓	✓	✓
	WC3036	8.0	✓	✓	✓	✓	✓	✓	✓
	WC3042	9.0	✓	✓	✓	✓	✓	✓	✓
 <ul style="list-style-type: none"> • Two butt doors • Two adjustable shelves • Blind cabinets can be pulled 3" • Blind opening is 7" on all sizes • Does not include filler • Available width: 42" 	WC4230	9.0	✓	✓	✓	✓	✓	✓	✓

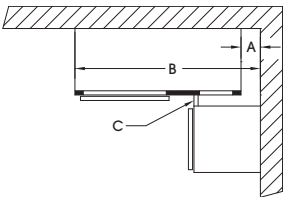

SKU	Cabinet Width	Blind Opening	Center Stile	A			B			C
				Minimum		Maximum	Minimum		Maximum	
				SO	FO		SO	FO		
WC24_ _	24"	7"	6"	0"	0"	3 1/2"	24"	24"	27 1/2"	N/A
WC30_ _	30"						30"	30"	33 1/2"	
WC42_ _	42"						42"	42"	45 1/2"	

A = Pull distance from wall
 B = Cabinet distance from wall
 C = Minimum filler width

SO = Standard Overlay (Hanover)
 FO = Full Overlay (Berwyn, Dartmouth, York, Waverly)

Note: Blind openings are right side: cabinet will be flipped during installation for left blind applications.

Base Cabinets – 24" Deep

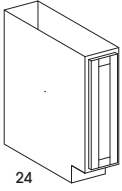
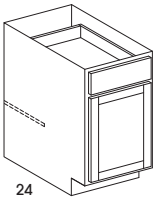
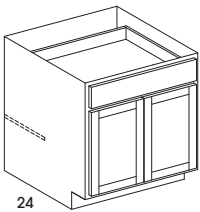
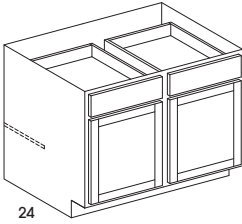
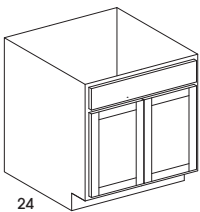
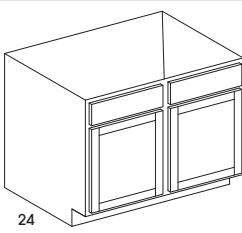
Design Tips: <ul style="list-style-type: none"> All single-door cabinets are hinged left Doors will be reversed during installation for right hinge applications 		SKU	cubes	STANDARD				COMPLEMENTS PAINT		
				Hanover	Dartmouth	Dartmouth 5-piece York Waverly	Berwyn	Hanover Complements Paint	Dartmouth Complements Paint	Dartmouth 5-piece York Waverly Complements Paint
BASE - 34 1/2" HIGH – 24" DEEP										
 <p>34 1/2 24</p>	<ul style="list-style-type: none"> One full height door Does not include adjustable shelf Available width: 9" 	B09FH	5.0	✓	✓	✓	✓	✓	✓	✓
 <p>34 1/2 24</p>	<ul style="list-style-type: none"> Single door One drawer One adjustable half-depth shelf Available widths: 12"-21" 	B12	6.0	✓	✓	✓	✓	✓	✓	
		B15	8.0	✓	✓	✓	✓	✓	✓	✓
		B18	9.0	✓	✓	✓	✓	✓	✓	✓
		B21	11.0	✓	✓	✓	✓	✓	✓	✓
 <p>34 1/2 24</p>	<ul style="list-style-type: none"> Two butt doors One drawer One adjustable half-depth shelf Available widths: 24"-36" 	B24DD	12.0	✓	✓	✓	✓	✓	✓	
		B27	13.0	✓	✓	✓	✓	✓	✓	✓
		B30	15.0	✓	✓	✓	✓	✓	✓	✓
		B33	16.0	✓	✓	✓	✓	✓	✓	✓
		B36	18.0	✓	✓	✓	✓	✓	✓	✓
 <p>34 1/2 24</p>	<ul style="list-style-type: none"> Two doors, cabinet with center stile Two drawers One adjustable half-depth shelf Available widths: 39" and 42" 	B39	20.0	✓	✓	✓	✓	✓	✓	
		B42	21.0	✓	✓	✓	✓	✓	✓	✓
SINK BASE – 34 1/2" HIGH – 24" DEEP										
 <p>34 1/2 24</p>	<ul style="list-style-type: none"> Two butt doors One false panel Available widths: 24"-36" 	SB24DD	12.0	✓	✓	✓	✓	✓	✓	
		SB27	13.0	✓	✓	✓	✓	✓	✓	✓
		SB30	15.0	✓	✓	✓	✓	✓	✓	✓
		SB33	16.0	✓	✓	✓	✓	✓	✓	✓
		SB36	18.0	✓	✓	✓	✓	✓	✓	✓
 <p>34 1/2 24</p>	<ul style="list-style-type: none"> Two doors, cabinet with center stile Two false panels Available width: 39" and 42" 	SB39	19.0	✓	✓	✓	✓	✓	✓	
		SB42	21.0	✓	✓	✓	✓	✓	✓	✓

Base Cabinets – 24" Deep

Design Tips: • All single-door cabinets are hinged left • Doors will be reversed during installation for right hinge applications	SKU	cubes	STANDARD				COMPLEMENTS PAINT		
			Hanover	Dartmouth	Dartmouth 5-piece York Waverly	Berwyn	Hanover Complements Paint	Dartmouth Complements Paint	Dartmouth 5-piece York Waverly Complements Paint

FARM SINK BASE – 34 1/2" HIGH – 24" DEEP

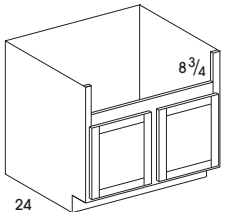
 <ul style="list-style-type: none"> • Two butt doors • Opening is 3" less than total width of cabinet and 8 3/4" high • Maximum cut out height: 10" • Available width: 36" 	FSB36	18.0	✓	✓	✓	✓	✓	✓	✓
------------------------------------------------------------------------------------------------------------------------------------------------------------------------------------------------------------------------------------------------------------------------------------------------------	-------	------	---	---	---	---	---	---	---

THREE DRAWER BASE – 34 1/2" HIGH – 24" DEEP

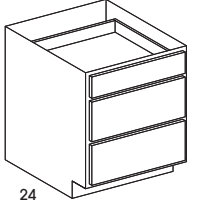
 <ul style="list-style-type: none"> • Three drawers • Available widths: 12"-36" 	DB12D3	6.0	✓	✓	✓	✓	✓	✓	✓
	DB15D3	8.0	✓	✓	✓	✓	✓	✓	✓
	DB18D3	9.0	✓	✓	✓	✓	✓	✓	✓
	DB21D3	11.0	✓	✓	✓	✓	✓	✓	✓
	DB24D3	12.0	✓	✓	✓	✓	✓	✓	✓
	DB30D3	15.0	✓	✓	✓	✓	✓	✓	✓
	DB36D3	18.0	✓	✓	✓	✓	✓	✓	✓

CORNER SINK BASE – 34 1/2" HIGH

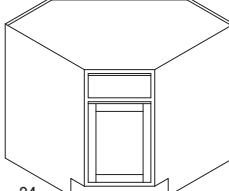
 <ul style="list-style-type: none"> • Single door • One false panel • Full cabinet 	SCB36	26.0	✓	✓	✓	✓	✓	✓	✓
	SCB42	34.0	✓	✓	✓	✓	✓	✓	✓

BASE CORNER – 34 1/2" HIGH – 24" DEEP

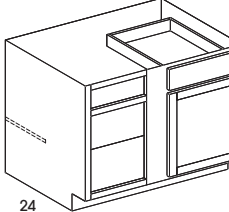
 <ul style="list-style-type: none"> • One door • One drawer • Drawer and door on right, can be reversed during installation • One adjustable half-depth shelf • Center stile is 6" • Does not include filler • Available widths: 36"-48" 	BC36	18.0	✓	✓	✓	✓	✓	✓	✓
	BC42	21.0	✓	✓	✓	✓	✓	✓	✓
	BC48	23.0	✓	✓	✓	✓	✓	✓	✓

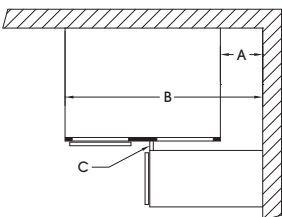

SKU	Cabinet Width	Blind Opening	Center Stile	A			B			C
				Minimum		Maximum	Minimum		Maximum	
				SO	FO		SO	FO		
BC36	27"	9"	6"	9 3/4"	10 1/2"	13 1/2"	36 3/4"	37 1/2"	40 1/2"	7/8"
BC42	36"	13 1/2"		5 1/4"	6"	9"	41 1/4"	42"	45"	
BC48	48"	19 1/2"		0"	0"	3"	48"	48"	51"	

A = Pull distance from wall **SO = Standard Overlay** (Hanover) Minimum filler width requirement (C) based on 7/8" high hardware
B = Cabinet distance from wall **FO = Full Overlay** (Berwyn, Dartmouth, York, Waverly)
C = Minimum filler width

Note: Blind openings are right side: door and drawer can be reversed during installation for left blind application.

Base Cabinets

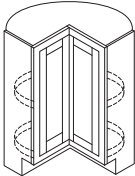
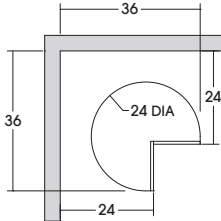
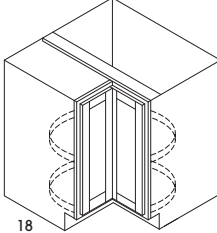
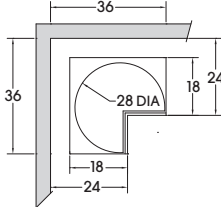
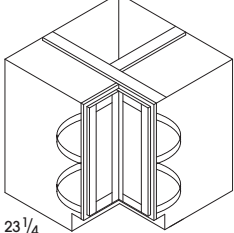
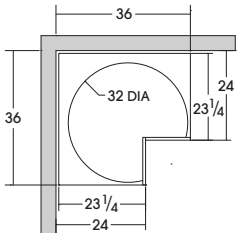
Design Tips: <ul style="list-style-type: none"> All single-door cabinets are hinged left Doors will be reversed during installation for right hinge applications 	SKU	cubes	STANDARD				COMPLEMENTS PAINT		
			Hanover	Dartmouth	Dartmouth 5-piece York Waverly	Berwyn	Hanover Complements Paint	Dartmouth Complements Paint	Dartmouth 5-piece York Waverly Complements Paint
BASE LAZY SUSAN - 34 1/2" HIGH									
 <p>34 1/2</p> <ul style="list-style-type: none"> Doors are attached to shelf and rotate with the shelf 24" diameter lazy susan Soft Close not available Available width: 36" 	LS36	26.0	✓	✓	✓	✓	✓	✓	✓
BASE SUSAN EASY REACH - 34 1/2" HIGH									
 <p>34 1/2</p> <p>18</p> <p>Use when household doorway opening is less than 34 1/2"</p> <ul style="list-style-type: none"> Bifold doors Independent rotating plastic shelves 28" diameter lazy susan Soft Close not available Available width: 36" <p>Note: SER36 cabinet depth is 18" deep for easy access and must be installed 6" from wall to align with adjacent 24" deep cabinet</p> 	SER36	26.0	✓	✓	✓	✓	✓	✓	✓
BASE SUPER SUSAN - 34 1/2" HIGH									
 <p>34 1/2</p> <p>23 1/4</p> <p>Household doorway Opening Requirement: Cabinet on side 34 1/4"</p> <ul style="list-style-type: none"> Bifold doors Independent rotating plastic shelves, center pole 32" diameter lazy susan Opening is 21 3/4" Soft Close not available Available width: 36" <p>Note: SS36 cabinet depth is 23 1/4" and must be installed 3/4" from wall to align with adjacent 24" deep cabinet</p> 	SS36	26.0	✓	✓	✓	✓	✓	✓	✓

Base Cabinets

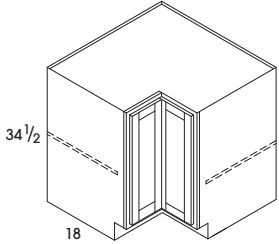
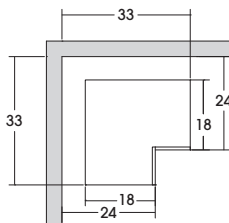
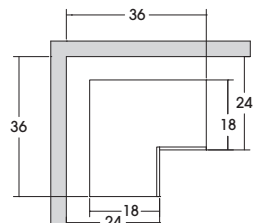
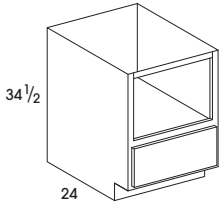
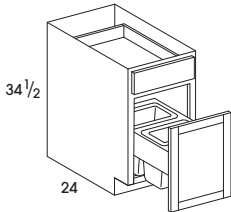
	SKU	cubes	STANDARD				COMPLEMENTS PAINT		
			Hanover	Dartmouth	Dartmouth 5-piece York Waverly	Berwyn	Hanover Complements Paint	Dartmouth Complements Paint	Dartmouth 5-piece York Waverly Complements Paint
BASE EASY REACH – 34 1/2" HIGH									
 <ul style="list-style-type: none"> • Bifold doors • Two adjustable shelves • Opening for BER33 is 10 1/2" • Opening for BER36 is 14 3/4" • Soft Close not available • Available widths: 33" and 36" <p>Note: BER33 and BER36 cabinet depth is 18" deep for easy access and must be installed 6" from wall to align with adjacent 24" deep cabinet</p>  	BER33	18.0	✓	✓	✓	✓	✓	✓	✓
BER36	26.0	✓	✓	✓	✓	✓	✓	✓	
BASE MICROWAVE CABINET – 34 1/2" HIGH – 24" DEEP									
 <ul style="list-style-type: none"> • Standard cabinets have matching interior in shelf area • Color Complements will have white interior in shelves area • Opening: 27" wide x 16" high • One lower drawer • Available width: 30" 	BMW30	15.0	✓	✓	✓	✓	✓	✓	✓
BASE WASTEBASKET CABINET – 34 1/2" HIGH – 24" DEEP									
 <ul style="list-style-type: none"> • Top mounted wastebaskets • Includes two white 35-quart trash cans • Wastebasket - Full-extension, side-mount ball bearing glides with Soft Close • Available width: 18" 	BWB18	9.0	✓	✓	✓	✓	✓	✓	✓

Shelves

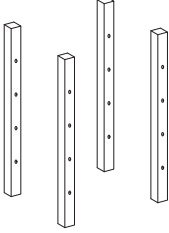
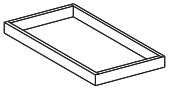
		SKU	cupbes	All Door Styles Used in 24" deep cabinets	
PULL-OUT INSTALL KIT					
 <ul style="list-style-type: none"> • Can be used with side-mount or undermount Soft Close glides • Multiple pull-out shelves can be used with one installation kit • Kits include four pilasters with predrilled holes and mounting hardware • Tall cabinets require two installation kits, depending on tray locations • Quick and easy to install one or multiple Pull-out shelves • Eliminates measuring and drilling 	ROINSTKIT	1.0	✓		
PULL-OUT SHELF FOR BASE AND TALL CABINETS					
 <ul style="list-style-type: none"> • PULL-OUT TRAYS WITH SOFT CLOSE (POSSC) REQUIRE PULL-OUT INSTALL KIT (ROINSTKIT) • POSSC - Soft Close, undermount, full extension glides • POS - Epoxy side-mounted glides; 3/4 extension • Single drawer • Inside height - 1 1/2" • Overall height - 2 1/4" • Solid wood dovetail construction • Includes 5/8" thick dovetailed drawer • 75 lb. capacity per shelf • FIELD INSTALLED • Available widths: 12"-36" 	<p>POS12 7 1/2" x 21"</p> <p>POS15 10 1/2" x 21"</p> <p>POS18 13 1/2" x 21"</p> <p>POS21 16 1/2" x 21"</p> <p>POS24 19 1/2" x 21"</p> <p>POS27 22 1/2" x 21"</p> <p>POS30 25 1/2" x 21"</p> <p>POS33 28 1/2" x 21"</p> <p>POS36 31 1/2" x 21"</p>	<p>1.0</p> <p>1.0</p> <p>1.0</p> <p>1.0</p> <p>1.0</p> <p>1.0</p> <p>1.0</p> <p>1.0</p> <p>1.0</p>	<p>✓</p> <p>✓</p> <p>✓</p> <p>✓</p> <p>✓</p> <p>✓</p> <p>✓</p> <p>✓</p>	<p>POSSC12 7 1/2" x 21"</p> <p>POSSC15 10 1/2" x 21"</p> <p>POSSC18 13 1/2" x 21"</p> <p>POSSC21 16 1/2" x 21"</p> <p>POSSC24 19 1/2" x 21"</p> <p>POSSC27 22 1/2" x 21"</p> <p>POSSC30 25 1/2" x 21"</p> <p>POSSC33 28 1/2" x 21"</p> <p>POSSC36 31 1/2" x 21"</p>	<p>✓</p> <p>✓</p> <p>✓</p> <p>✓</p> <p>✓</p> <p>✓</p> <p>✓</p> <p>✓</p>

Tall Cabinets – 24" Deep

Design Tips: • All single-door cabinets are hinged left • Doors will be reversed during installation for right hinge applications	SKU	cubes	STANDARD				COMPLEMENTS PAINT			
			Hanover	Dartmouth	Dartmouth 5-piece York Waverly	Berwyn	Hanover Complements Paint	Dartmouth Complements Paint	Dartmouth 5-piece York Waverly Complements Paint	

UTILITY CABINET – 24" DEEP

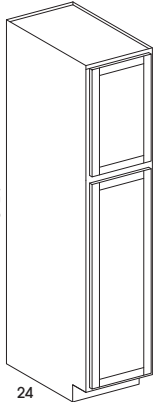
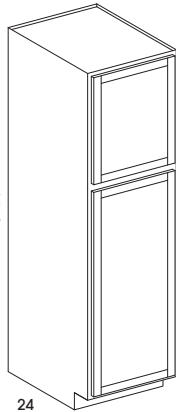
 <ul style="list-style-type: none"> • Two doors • Shelves not included • Unfinished toekick is attached to all utility cabinets • Available width: 18" 	U188424	21.0	✓	✓	✓	✓	✓	✓	✓
	U189024	23.0	✓	✓	✓	✓	✓	✓	✓
	U189624	24.0	✓	✓	✓	✓	✓	✓	✓
 <ul style="list-style-type: none"> • Two doors • Shelves not included • Unfinished toekick is attached to all utility cabinets • Available width: 24" 	U248424	28.0	✓	✓	✓	✓	✓	✓	✓
	U249024	30.0	✓	✓	✓	✓	✓	✓	✓
	U249624	32.0	✓	✓	✓	✓	✓	✓	✓

SKU	cubes	White	Natural
-----	-------	-------	---------

UTILITY CABINET SHELF

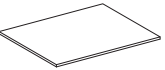
 <ul style="list-style-type: none"> • SHELFKIT includes four shelves and clips • SHELF includes single shelf only, no clips • 1824 shelf: 22²/₁₆" x 16³/₁₆" • 2424 shelf: 22³/₁₆" x 22³/₁₆" 	U1824SHELFK	1.0	✓	✓
	U1824SHELF	1.0	✓	✓
	U2424SHELFK	1.0	✓	✓
	U2424SHELF	1.0	✓	✓

Tall Cabinets – 24" Deep

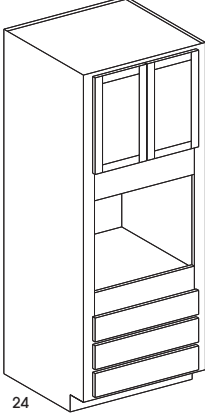
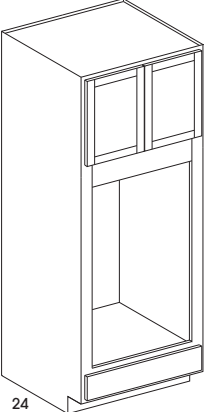
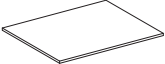
	SKU	cubes	STANDARD				COMPLEMENTS PAINT																	
			Hanover	Dartmouth	Dartmouth 5-piece York Waverly	Berwyn	Hanover Complements Paint	Dartmouth Complements Paint	Dartmouth 5-piece York Waverly Complements Paint															
OVEN CABINET – 24" DEEP																								
 <ul style="list-style-type: none"> • Two butt doors • No shelves included in upper cabinet • If desired order OCSHELF below for 90" and 96" tall oven cabinets • Inside opening is natural/white • Three bottom drawers • Two top drawers may be removed and cut to create a Double Oven opening • Oven cabinet has a 3" left and right stile running the entire height of the cabinet • Max cut out height = 33 1/4" • Max cut out width = 31" • Dartmouth and York doors and drawers are not full overlay • Available width: 33" <table border="1" data-bbox="168 905 760 1052"> <thead> <tr> <th colspan="3">Oven Cabinet</th> </tr> <tr> <th>SKU</th> <th>Oven Opening</th> <th>Upper Cabinet Opening</th> </tr> </thead> <tbody> <tr> <td>OC338424</td> <td>27" wide x 24" high</td> <td>27" wide x 18 3/4" high</td> </tr> <tr> <td>OC339024</td> <td>27" wide x 24" high</td> <td>27" wide x 24 3/4" high</td> </tr> <tr> <td>OC339624</td> <td>27" wide x 24" high</td> <td>27" wide x 30 3/4" high</td> </tr> </tbody> </table>	Oven Cabinet			SKU	Oven Opening	Upper Cabinet Opening	OC338424	27" wide x 24" high	27" wide x 18 3/4" high	OC339024	27" wide x 24" high	27" wide x 24 3/4" high	OC339624	27" wide x 24" high	27" wide x 30 3/4" high	OC338424	39.0	See Special Order Section	✓	✓	✓	✓	✓	✓
	Oven Cabinet																							
	SKU	Oven Opening	Upper Cabinet Opening																					
OC338424	27" wide x 24" high	27" wide x 18 3/4" high																						
OC339024	27" wide x 24" high	27" wide x 24 3/4" high																						
OC339624	27" wide x 24" high	27" wide x 30 3/4" high																						
	OC339024	42.0	See Special Order Section	✓	✓	✓	✓	✓	✓															
	OC339624	44.0	See Special Order Section	✓	✓	✓	✓	✓	✓															
DOUBLE OVEN – 24" DEEP																								
 <ul style="list-style-type: none"> • Two butt doors • No shelves included in upper cabinet • If desired order OCSHELF below for 96" tall oven cabinets • Inside opening is natural/white • One drawer • Oven opening: 47 1/4" high x 27" wide • Rail below upper cabinets is 6" high and can be trimmed or removed for an opening height up to 53 1/4" • Maximum trim width to end panels is 31 3/4" • Available width: 33" 	OCD339624	44.0	✓	✓	✓	✓	✓	✓	✓															
OVEN CABINET SHELF																								
 <ul style="list-style-type: none"> • Full depth 3/4" shelf to add to the upper cabinet of 90" and 96" tall cabinet • 22 3/16" x 31 3/16" • Shelf clips must be ordered separately • Available in white and natural maple 	OC3324SHELF	1.0	✓	✓	✓	✓	N/A	N/A	N/A															

Vanity Cabinets – 21" Deep

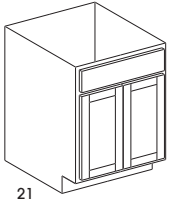
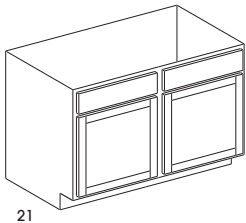
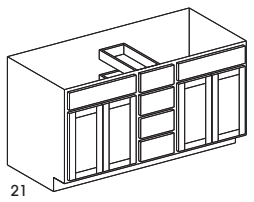
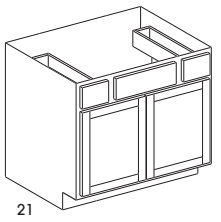
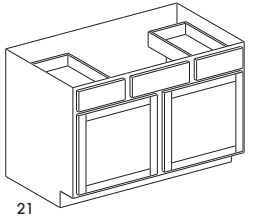
Design Tips: <ul style="list-style-type: none"> All single-door cabinets are hinged left Doors will be reversed during installation for right hinge applications 		SKU	cubes	STANDARD				COMPLEMENTS PAINT			
				Hanover	Dartmouth	Dartmouth 5-piece York Waverly	Berwyn	Hanover Complements Paint	Dartmouth Complements Paint	Dartmouth 5-piece York Waverly Complements Paint	
VANITY SINK BASE – 34 1/2" HIGH – 21" DEEP											
 <p>34 1/2 21</p> <ul style="list-style-type: none"> Two butt doors One false panel Available widths: 24"-36" 	VSB24DD	11.0	✓	✓	✓	✓	✓	✓	✓		
	VSB27	12.0	✓	✓	✓	✓	✓	✓	✓		
	VSB30	13.0	✓	✓	✓	✓	✓	✓	✓		
	VSB33	14.0	✓	✓	✓	✓	✓	✓	✓		
	VSB36	16.0	✓	✓	✓	✓	✓	✓	✓		
 <p>34 1/2 21</p> <ul style="list-style-type: none"> Two doors with center mullion Two false panels Available width: 48" 	VSB48	21.0	✓	✓	✓	✓	✓	✓			
VANITY SINK DRAWER BASE – 34 1/2" HIGH – 21" DEEP											
 <p>34 1/2 21</p> <ul style="list-style-type: none"> Two sets of butt doors Two false fronts Four drawers in center Center drawers area is 12" wide Available width: 60" 	VSB60DB4	26.0	✓	✓	✓	✓	✓	✓			
VANITY SINK DRAWER BASE – 34 1/2" HIGH – 21" DEEP											
 <p>34 1/2 21</p> <ul style="list-style-type: none"> Two butt doors Two drawers One false panel Available width: 36" 	VSDB36	16.0	✓	✓	✓	✓	✓	✓			
 <p>34 1/2 21</p> <ul style="list-style-type: none"> Two doors, cabinet with center stile Two drawers One false panel Available widths: 42" and 48" 	VSDB42	18.0	✓	✓	✓	✓	✓	✓			
	VSDB48	21.0	✓	✓	✓	✓	✓	✓			

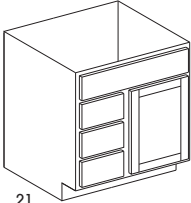
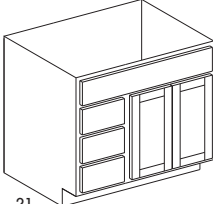
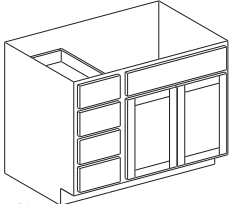
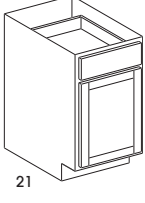
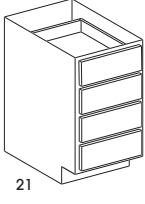

Vanity Cabinets – 21" Deep

Design Tips: <ul style="list-style-type: none"> All single-door cabinets are hinged left Doors will be reversed during installation for right hinge applications 		SKU	cubes	STANDARD				COMPLEMENTS PAINT			
				Hanover	Darimouth	Darimouth 5-piece York Waverly	Benwyn	Hanover Complements Paint	Darimouth Complements Paint	Darimouth 5-piece York Waverly Complements Paint	
VANITY COMBO CABINET – 34 1/2" HIGH – 21" DEEP											
 <p>34 1/2 21</p> <ul style="list-style-type: none"> Single door One false panel VBL: three drawers on left VBR: three drawers on right Accommodates center bowl top Available width: 30" 	VBL30	13.0	✓	✓	✓	✓	✓	✓	✓		
	VBR30	13.0	✓	✓	✓	✓	✓	✓	✓		
 <p>34 1/2 21</p> <ul style="list-style-type: none"> Two butt doors One false panel VBL: three drawers on left VBR: three drawers on right Accommodates center bowl top Available width: 36" 	VBL36	15.0	✓	✓	✓	✓	✓	✓	✓		
	VBR36	15.0	✓	✓	✓	✓	✓	✓	✓		
 <p>34 1/2 21</p> <ul style="list-style-type: none"> Two butt doors One false panel VBL: four drawers on left VBR: four drawers on right Accommodates center bowl top Available width: 42" 	VBL42	18.0	✓	✓	✓	✓	✓	✓	✓		
	VBR42	18.0	✓	✓	✓	✓	✓	✓	✓		
VANITY BASE CABINET – 34 1/2" HIGH – 21" DEEP											
 <p>34 1/2 21</p> <ul style="list-style-type: none"> Single door One drawer Available widths: 12"-18" 	VB12	6.0	✓	✓	✓	✓	✓	✓	✓		
	VB15	7.0	✓	✓	✓	✓	✓	✓	✓		
	VB18	8.0	✓	✓	✓	✓	✓	✓	✓		
VANITY DRAWER BASE CABINET – 34 1/2" HIGH – 21" DEEP											
 <p>34 1/2 21</p> <ul style="list-style-type: none"> Four drawers Available widths: 12"-18" 	VDB12	6.0	✓	✓	✓	✓	✓	✓	✓		
	VDB15	7.0	✓	✓	✓	✓	✓	✓	✓		
	VDB18	8.0	✓	✓	✓	✓	✓	✓	✓		

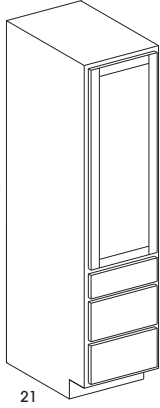
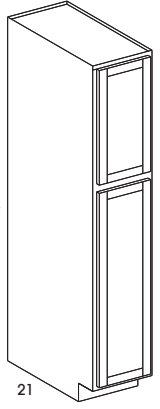
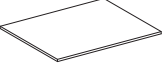
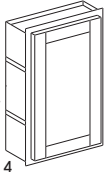
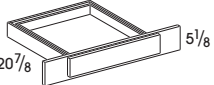
Vanity Cabinets – 21" Deep

Design Tips: <ul style="list-style-type: none"> All single-door cabinets are hinged left Doors will be reversed during installation for right hinge applications 		SKU	cubes	STANDARD				COMPLEMENTS PAINT		
				Hanover	Darimouth	Darimouth 5-piece York Waverly	Benwyn	Hanover Complements Paint	Darimouth Complements Paint	Darimouth 5-piece York Waverly Complements Paint
LINEN CABINET WITH DRAWERS – 21" DEEP										
 <p>80 21 See Note</p>	<ul style="list-style-type: none"> One door Three drawers One fixed shelf between door and drawers Three shelves included in upper cabinet Available width: 18" <p>Note: Top drawer front is approximately 30" high and will not align with other vanity cabinets</p>	LCD188021	18.0	✓	✓	✓	✓	✓	✓	✓
LINEN CABINET – 21" DEEP										
 <p>84 21</p>	<ul style="list-style-type: none"> Two doors Shelves not included Unfinished toekick is attached Available width: 15" 	LC158421	16.5	✓	✓	✓	✓	✓	✓	✓
LINEN CABINET SHELF KIT										
	<ul style="list-style-type: none"> Includes four shelves and clips 	LC1521SHELFK	1.0	✓	✓	✓	✓	N/A	N/A	N/A
MEDICINE CABINET – 24" HIGH – 4" DEEP										
 <p>24 4</p>	<ul style="list-style-type: none"> Single door (no mirror) Two fixed shelves, not adjustable Cutout for recessed installation: 14½" wide x 23" high May be surface mounted if trimmed out Available width: 15" 	WMC1524	14.0	✓	✓	✓	✓	✓	✓	✓
UNDERMOUNT DRAWER – 21" DEEP										
 <p>20 7/8 5 1/8</p>	<ul style="list-style-type: none"> Trimmable to 27½" wide One-piece drawer front on all door styles Drawer front is 4 3/8" Available width: 36" 	VDT36	3.0	✓	✓	✓	✓	✓	✓	✓

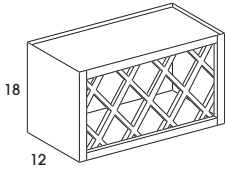

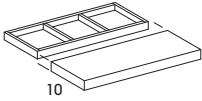
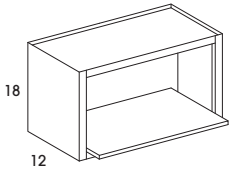
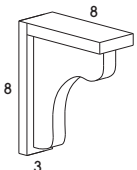

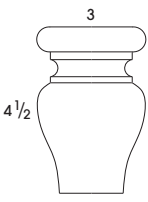
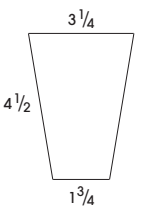
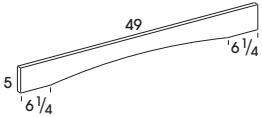
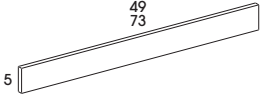

Accessories

	SKU	cupes	Stain	Paint	Complements Paint
WINE RACK - 18" HIGH - 12" DEEP					
 <ul style="list-style-type: none"> • Matching interior and exterior • Available width: 30" 	WR30	4.0	✓	✓	N/A
STEM GLASS HOLDER - 12" DEEP					
 <ul style="list-style-type: none"> • Available widths: 30" and 36" 	SGH30	1.0	✓	✓	N/A
	SGH36	1.0	✓	✓	N/A
FLOATING SHELVES					
 <ul style="list-style-type: none"> • 2½" Thick • 10" Deep • Supports up to 100 lbs. • Must be supported by a minimum of two stud walls • Available widths: 24"-48" 	FSHELF24	1.0	✓	✓	✓
	FSHELF30	1.0	✓	✓	✓
	FSHELF36	1.0	✓	✓	✓
	FSHELF42	1.0	✓	✓	✓
	FSHELF48	1.0	✓	✓	✓
MICROWAVE WALL CABINET - 12" DEEP					
 <ul style="list-style-type: none"> • Inside dimensions: 27" wide x 15" tall • Includes 14" deep, ¾" thick plywood microwave shelf (installed within the opening; requires a spacer to level shelf) • Finished interior to match exterior • Available width: 30" <p>Note: If selected with a Color Complement, shelf will be painted, interior will not</p>	MWC3018	4.0	✓	✓	✓
BAR BRACKET					
 <ul style="list-style-type: none"> • 8" high x 8" deep 	BARBRACKET	0.1	✓	✓	✓





Accessories

	SKU	cases	Stain	Paint	Complements Paint
BUN FOOT					
 <ul style="list-style-type: none"> • 4 1/2" high x 3" wide 	BFOOT	0.1	✓	✓	✓
TAPERED FOOT					
 <ul style="list-style-type: none"> • 1 3/4" wide at the bottom • 3 1/4" wide at the top • 4 1/2" high 	TFOOT	0.1	✓	✓	✓
ROMAN ARCH VALANCE					
 <ul style="list-style-type: none"> • All valances are 3/4" thick solid maple • Stained valances have a profiled edge • White valances have Dartmouth edge profile • Available width: 49" 	V549RA	0.3	✓	✓	✓
STRAIGHT VALANCE					
 <ul style="list-style-type: none"> • All valances are 3/4" thick solid maple • Stained valances have a profiled edge • White valances have Dartmouth edge profile • Finished two sides; Front face and profiled edge • Available widths: 49" and 73" 	V549ST	0.3	✓	✓	✓
	V573ST	0.3	✓	✓	✓



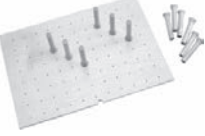

Storage Solutions

Design Tips:		SKU	cupes	Availability
<ul style="list-style-type: none"> All storage solutions are field installed Cabinet fit sizes are based on 34 1/2" cabinet heights 				
SPICE DRAWER INSERT KIT				
 <ul style="list-style-type: none"> Trim to fit Maple construction with natural finish B1518SPICEK fits B15 and B18 cabinets Dimensions: 16" W x 19 3/4" D x 1 1/2" H B2124SPICEK fits B21 and B24 cabinets Dimensions: 22" W x 19 3/4" D x 1 1/2" H B2736SPICEK fits B27, B30, B33 and B36 cabinets Dimensions: 33 1/8" W x 19 3/4" D x 1 3/4" H 	B1518SPICEK	0.5	✓	
	B2124SPICEK	0.6	✓	
	B2736SPICEK	0.7	✓	
K-CUP DRAWER ORGANIZER KIT				
 <ul style="list-style-type: none"> Holds 30 K-Cups Maple construction with natural finish B18KCUPK fits B18 cabinets Dimensions: 16" W x 19 3/4" D x 2 3/8" H B24KCUPK fits B24 cabinets Dimensions: 16" W x 19 3/4" D x 2 3/8" H 	B18KCUPK	0.6	✓	
	B24KCUPK	0.9	✓	
DRAWER CUTLERY INSERT KIT				
 <ul style="list-style-type: none"> Trim to fit Maple construction with natural finish B1518CUTK fits B15 and B18 cabinets Dimensions: 14 5/8" W x 22" D x 2 7/8" H B2124CUTK fits B21 and B24 cabinets Dimensions: 20 5/8" W x 22" D x 2 7/8" H 	B1518CUTK	0.7	✓	
	B2124CUTK	0.9	✓	
 <ul style="list-style-type: none"> Trim to fit Maple construction with natural finish B3036CUTK fits B30, B33 and B36 cabinets Dimensions: 33 1/8" W x 22" D x 2 7/8" H 	B3036CUTK	1.1	✓	
KNIFE BLOCK INSERT KIT				
 <ul style="list-style-type: none"> Trim to fit Maple construction with natural finish 55 slots to store various sized knives and other utensils B1521KNK fits B15, B18 and B21 cabinets Dimensions: 18 1/2" W x 22" D x 2" H 	B1521KNK	0.7	✓	
 <ul style="list-style-type: none"> Trim to fit Maple construction with natural finish B3036KNK fits B30, B33 and B36 cabinets Dimensions: 33 1/8" W x 22" D x 2 7/8" H 	B3036KNK	1.0	✓	
BASE UTILITY DRAWER KIT				
 <ul style="list-style-type: none"> Trim to fit Maple construction with natural finish B2736UTK fits B27, B30, B33 and B36 cabinets Dimensions: 33 1/8" W x 22" D x 2 7/8" H 	B2736UTK	1.0	✓	





Storage Solutions

<p>Design Tips:</p> <ul style="list-style-type: none"> All storage solutions are field installed Cabinet fit sizes are based on 34 1/2" cabinet heights 	SKU	cubes	Availability
PEG ORGANIZATION SYSTEM KIT			
 <ul style="list-style-type: none"> Peg organization for deep drawers Trim to fit Maple construction with natural finish DB30PEGK fits DB30 and BMW30 bottom drawers Includes (12) push-in pegs Dimensions: 30 3/8" W x 21 1/2" D x 6 3/4" H DB36PEGK fits DB36 bottom drawers Includes (16) push-in pegs Dimensions: 39 3/8" W x 21 1/2" D x 6 3/4" H 	DB30PEGK	1.0	✓
	DB36PEGK	1.1	✓
DOOR MOUNT CUTTING BOARD KIT			
 <ul style="list-style-type: none"> Premium wood cutting board Includes cutting board and door mount holder Cutting board is birch and maple combination B15DMCBK fits 15" wide cabinets Cutting board dimensions: 7 3/4" W x 16" H x 1 1/4" D B18DMCBK fits 18" wide cabinets Cutting board dimensions: 10 3/4" W x 16" H x 1 1/4" D 	B15DMCBK	0.3	✓
	B18DMCBK	0.4	✓
DOOR STORAGE KIT			
 <ul style="list-style-type: none"> Door mounted sink base storage Top shelf with plastic insert Bottom shelf for tall item storage Maple construction with natural finish SB3033DSTK fits cabinet with 15" wide doors SB36DSTK fits cabinet with 18" wide doors SB42DSTK fits cabinet with 21" wide doors 	SB3033DSTK	0.3	✓
	SB36DSTK	0.4	✓
	SB42DSTK	0.5	✓
APPLIANCE STORAGE RACK KIT			
 <ul style="list-style-type: none"> Door mounted appliance storage Top shelf with (2) 1 1/4 qt stainless steel bins Non-skid lining on lower level shelf Maple construction with natural finish VSB30ASTK fits cabinet with 15" wide doors 	VSB30ASTK	0.5	✓
DOOR MOUNT WASTE BIN KIT			
 <ul style="list-style-type: none"> Door mounted waste container Includes one silver, 8-quart waste bin Door mount is maple construction with natural finish VSB30DWBK fits cabinet with 15" wide doors 	VSB30DWBK	0.5	✓





Storage Solutions

<p>Design Tips:</p> <ul style="list-style-type: none"> All storage solutions are field installed Cabinet fit sizes are based on 34½" cabinet heights 	SKU	cubes	Availability
SINK BASE TIP-OUT TRAY KIT			
 <ul style="list-style-type: none"> Includes one conventional open tray and one accessory tray with soap dish Both 11" trays are white plastic SB2736TIPK fits SB27, SB30, SB33 and SB36, includes one pair of hinges for single drawer front SB3942TIPK fits SB39 and SB42, includes two pair of hinges for double drawer front Can be used on vanity sink bases 	SB2736TIPK	1.8	✓
	SB3942TIPK	1.8	✓
SINK BASE STAINLESS STEEL, SOFT CLOSE TIP-OUT TRAY KIT			
 <ul style="list-style-type: none"> Includes one stainless steel Tip-out Tray with Soft Close hinges Designed for sink base cabinets with one wide drawer front SB30TIPSSK is 25" wide and fits 30" wide sink base cabinets SB33TIPSSK is 28" wide and fits 33" wide sink base cabinets SB36TIPSSK is 31" wide and fits 36" wide sink base cabinets 	SB30TIPSSK	1.8	✓
	SB33TIPSSK	1.8	✓
	SB36TIPSSK	1.8	✓
SINK BASE DRIP TRAY KIT			
 <ul style="list-style-type: none"> Protects cabinets from minor leaks Almond color Trim to fit SB2730DRIPK fits SB27 and SB30 cabinets SB3336DRIPK fits SB33 and SB36 cabinets SB3942DRIPK fits SB39 and SB42 cabinets 	SB2730DRIPK	0.4	✓
	SB3336DRIPK	0.5	✓
	SB3942DRIPK	0.6	✓
SINK BASE REMOVABLE CADDY KIT			
 <ul style="list-style-type: none"> Adjustable/reversible handle and top tray accommodate plumbing fixtures May not fit unusual plumbing configurations Full extension euro-glides with 75 lb rating Door mount bracket not available Easy removal to carry around house Width: 11¼" Fits all sink base cabinets 	SBREMCADK	1.2	✓
WALL DIAGONAL LAZY SUSAN SHELF KIT			
 <ul style="list-style-type: none"> Rotating D-shaped lazy susan Mounts to bottom of cabinet or shelves 5/8" thick shelf with 1" rim Natural maple finish Fits Wall Diagonal corner cabinets 	WDC24LSK	1.0	✓





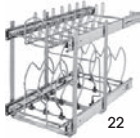

Storage Solutions

Design Tips:		SKU	cubes	Availability
<ul style="list-style-type: none"> All storage solutions are field installed Cabinet fit sizes are based on 34½" cabinet heights 				
LAZY SUSAN UPGRADE KIT				
	<ul style="list-style-type: none"> Wood lazy susan to be installed in a Super Susan cabinet (SS36) Two trays each 28" diameter 5/8" thick maple independently operated revolving trays Trays have a 2" high banded wood rim 	SS36LSUK	2.0	✓
BASE CORNER LAZY SUSAN PULL-OUT KIT				
	<ul style="list-style-type: none"> Chrome plated pivoting shaft Two half moon shelves Shelves rotate and pull out independently Shelves are white polymer Pull out distance is 10¼" BC42LSPOK fits blind corner cabinet BC42 BC48LSPOK fits blind corner cabinet BC48 	BC42LSPOK	2.1	✓
		BC48LSPOK	2.6	✓
BASE TRAY DIVIDER KIT				
	<ul style="list-style-type: none"> Chrome finish TD12K Dimensions: ¼" W x 20" D x 12" H TD18K Dimensions: ¼" W x 20" D x 18" H Fits all base, refrigerator wall and tall cabinets 24" deep 	TD12K	0.2	✓
		TD18K	0.2	✓
3" BASE FILLER PULL-OUT KIT				
	<ul style="list-style-type: none"> 3" wide base filler pull-out creates a functional storage space Recommended installation is between two cabinets Can also be installed between cabinet and a wall or cabinet and end panel with a stile Full extension Soft Close glides Requires a filler mounted to front; filler sold separately Three adjustable shelves 	BFPO3K	1.2	✓
6" BASE FILLER PULL-OUT KIT				
	<ul style="list-style-type: none"> 6" wide base filler pull-out creates a functional storage space Recommended installation is between two cabinets Can also be installed between cabinet and a wall or cabinet and end panel with a stile Full extension Soft Close glides Requires a filler mounted to front; filler sold separately Three adjustable shelves 	BFPO6K	1.6	✓

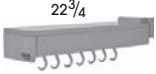
Storage Solutions

Design Tips:		SKU	cubes	Availability
<ul style="list-style-type: none"> All storage solutions are field installed Cabinet fit sizes are based on 34 1/2" cabinet heights 				
WALL ORGANIZER PULL-OUT KIT				
 <p>26 1/16 10 3/4</p>	<ul style="list-style-type: none"> Two adjustable shelves with chrome rails Fixed top shelf for 36" and 42" high cabinets Full extension, Soft Close glides Door mount bracket with 5" of width and micro-tilt adjustment Natural maple finish W09POK fits 9" wide wall cabinets W12POK fits 12" wide wall cabinets 	W09POK	1.1	✓
		W12POK	1.6	✓
BASE FULL HEIGHT ORGANIZER PULL-OUT KIT				
 <p>25 1/2 22 1/2</p>	<ul style="list-style-type: none"> Three adjustable shelves with chrome rails Full extension, Soft Close glides Door mount bracket with 5" of width and micro-tilt adjustment Natural maple finish Fits B09 with full-height door 	B09POK	2.2	✓
BASE FULL HEIGHT UTENSIL ORGANIZER PULL-OUT KIT				
 <p>25 1/2 22 1/2</p>	<ul style="list-style-type: none"> Two adjustable shelves with chrome rails Full extension, Soft Close glides Door mount bracket with 5" of width and micro-tilt adjustment Natural maple finish Includes three stainless steel bins Fits B09 with full-height door 	B09POUTK	3.1	✓
BASE ORGANIZER PULL-OUT KIT				
 <p>19 1/2 21 5/8</p>	<ul style="list-style-type: none"> Two adjustable shelves with chrome rails Full extension, Soft Close glides Door mount bracket with 5" of width and micro-tilt adjustment Natural maple finish Fits B15 cabinet 	B15POK	6.1	✓
BASE POTS AND PANS ORGANIZER KIT				
 <p>18 22</p>	<ul style="list-style-type: none"> Chrome plated wire frame Full extension, ball bearing slides - 100 lb. rated Independently operating shelves Top tier organizes lids Bottom tier with adjustable dividers B15PPORGK fits B15 cabinet B24PPORGK fits B24 cabinet 	B15PPORGK	4.7	✓
		B24PPORGK	6.7	✓

Storage Solutions

Design Tips:		SKU	cupes	Availability
<ul style="list-style-type: none"> All storage solutions are field installed Cabinet fit sizes are based on 34 1/2" cabinet heights 				
BASE POTS AND PANS ORGANIZER KIT				
 <p>22 3/4 5</p>	<ul style="list-style-type: none"> Includes seven long hooks Solid wood with grey finish Full extension, Soft Close glides Fits all 24" deep cabinets 	PPORGK	0.6	✓
BASE STORAGE ORGANIZER KIT				
 <p>18 21 1/2</p>	<ul style="list-style-type: none"> Maple dovetail, bottom mount pull-out Undermount, Soft Close glides Includes seven chrome "U-shaped" pegs Freestanding pull-out B18ORGK fits B18 cabinet (5 adjustable dividers) B24ORGK fits B24 (8 adjustable dividers) 	B18ORGK	4.7	✓
		B24ORGK	6.7	✓
TIERED COOKWARE ORGANIZER KIT				
	<ul style="list-style-type: none"> Two-tiered cookware organizer Natural maple construction Top shelf holds lids Organizer is pulled out after opening the door Undermount, Soft Close glides B18CWORGK fits B18 cabinet B24CWORGK fits B24 cabinet 	B18CWORGK	4.7	✓
		B24CWORGK	6.7	✓
BASE WASTEBASKET, SINGLE KIT				
 <p>19 1/2 21 3/4</p>	<ul style="list-style-type: none"> Single, 35-quart silver container Maple dovetail, bottom mount pull-out Full extension, Soft Close glides Mounts to cabinet bottom and door Door mount bracket with 5" of width and micro-tilt adjustment Fits B15 cabinet 	B15WBK	4.8	✓
BASE WASTEBASKET, DOUBLE KIT				
 <p>19 1/2 21 3/4</p>	<ul style="list-style-type: none"> Double, 35-quart silver containers Maple dovetail, bottom mount pull-out Full extension, Soft Close glides Mounts to cabinet bottom and door Door mount bracket with 5" of width and micro-tilt adjustment Fits B18 cabinet 	B18WBK	5.5	✓
 <p>19 1/2 21 3/4</p>	<ul style="list-style-type: none"> Double, 35-quart silver containers Maple dovetail, bottom mount pull-out Full extension, Soft Close glides Mounts to cabinet bottom and door Door mount bracket with 5" of width and micro-tilt adjustment Fits B21 cabinet 	B21WBK	6.9	✓

Fillers & Panels

		SKU	Quantity	Finish	Paint	Complements Paint
FILLER – STANDARD						
	<ul style="list-style-type: none"> Fillers are 3/4" thick solid maple Fillers are finished on the face, left, and right sides; however, the sides receive a lesser finish If you require an end to be exposed, we suggest using a valance F330 and F360 may be used for either bases or 30" walls Available widths: 3" and 6" 	F330	0.1	✓	✓	✓
		F630	0.2	✓	✓	✓
		WF336	0.1	✓	✓	✓
		WF636	0.2	✓	✓	✓
		WF342	0.1	✓	✓	✓
		WF642	0.2	✓	✓	✓
		F396	0.1	✓	✓	✓
		F696	0.2	✓	✓	✓
		FILLER – FLUTED				
	<ul style="list-style-type: none"> Fillers are 3/4" thick solid maple Fillers are finished on the face, left, and right sides; however, the sides receive a lesser finish If you require an end to be exposed, we suggest using a valance FF330 may be used for either bases or 30" walls Available width: 3" 	FF330	0.1	✓	✓	✓
		FF396	0.1	✓	✓	✓

		SKU	Quantity	STANDARD				COMPLEMENTS PAINT		
				Hanover	Dartmouth	Dartmouth 5-piece York Waverly	Berwyn	Hanover Complements Paint	Dartmouth Complements Paint	Dartmouth 5-piece York Waverly Complements Paint
DECORATIVE END PANELS										
<ul style="list-style-type: none"> All decorative end panels are actual doors that are finished on both sides Tall decorative end panels available as special order with added lead time These panels are top and bottom doors from U24 	DWEP30	0.1	✓	✓	✓	✓	✓	✓	✓	
	DWEP36	0.1	✓	✓	✓	✓	✓	✓	✓	
	DWEP42	0.1	✓	✓	✓	✓	✓	✓	✓	
	DEPVB	0.1	✓	✓	✓	✓	✓	✓	✓	
	DEPB	0.1	✓	✓	✓	✓	✓	✓	✓	

SKU	Hanover Dimensions	Berwyn, Dartmouth, York, Waverly Dimensions
DWEP30	10" x 28"	11 1/4" x 29 7/8"
DWEP36	10" x 34	11 1/4" x 35 7/8"
DWEP42	10" x 40"	11 1/4" x 41 7/8"
DEPVB	19" x 28"	20 1/4" x 29"
DEPB	22" x 28"	23 1/4" x 29"

Fillers & Panels

Design Tips: *Panels are finished to match with vinyl laminate on "face" side only • Inner side finished in natural vinyl laminate on stained products • Inner side finished in white vinyl laminate on painted products	SKU	cubes	Stain	Paint	Complements Paint
PANELS					
P4836: Finished End Panel — 48" x 36" x 1/4" (grain runs with 36") — plywood veneer	P4836	1.0	✓	N/A	N/A
P4836V: Finished End Panel — 48" x 36" x 1/4" (grain runs with 36") — vinyl	P4836V	1.0	✓	✓	✓
P4896: Finished End Panel — 48" x 96" x 1/4" (grain runs with 96") — plywood veneer	P4896	1.0	✓	N/A	N/A
P4896V: Finished End Panel — 48" x 96" x 1/4" (grain runs with 96") — vinyl	P4896V	1.0	✓	✓	✓
BP4896: Finished Beaded Panel — 48" x 96" x 1/4" (bead runs with 96") — stained styles are stained plywood veneer/painted are vinyl — spacing between beads is approximately 1 3/4"	BP4896	1.0	✓	✓	✓
WSKIN: Finished Panel — 11 1/4" x 42" x 1/4" — stained styles are stained plywood veneer/painted are vinyl	WSKIN	1.0	✓	✓	✓
BSKIN: Finished Panel — 23 1/4" x 34 1/2" x 1/4" — stained styles are stained plywood veneer/painted are vinyl	BSKIN	1.0	✓	✓	✓
*REFP24: Finished Refrigerator Panel — 24" x 96" with 1 1/2" stile — 1/2" vinyl laminate, plywood panel	REFP24	2.0	✓	✓	✓
3/4REFP24: Finished Refrigerator Panel — 3/4" x 24" x 96" Panel finished on two sides & one long edge. Plywood. Stained product is finished veneer. Painted product is vinyl.	3/4REFP24	2.0	✓	✓	✓
*REFP30: Finished Refrigerator Panel — 30" x 96" with 1 1/2" stile — 1/2" vinyl laminate, plywood panel	REFP30	3.0	✓	✓	✓
3/4REFP30: Finished Refrigerator Panel — 3/4" x 30" x 96" Panel finished on two sides & one long edge. Plywood. Stained product is finished veneer. Painted product is vinyl.	3/4REFP30	2.0	✓	✓	✓
*DWP1.5: Dishwasher End Panel with 1 1/2" filler — 24" x 34 1/2" with 1 1/2" stile — 1/2" vinyl laminate panel	DWP1.5	2.0	✓	✓	✓
*DWP3: Dishwasher End Panel with 3" filler — 24" x 34 1/2" with 3" stile — 1/2" vinyl laminate panel	DWP3	2.0	✓	✓	✓
*DWP6: Dishwasher End Panel with 6" filler — 24" x 34 1/2" tall with 6" stile — 1/2" vinyl laminate panel	DWP6	3.0	✓	✓	✓

Mouldings

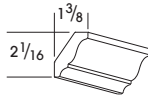
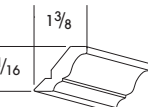
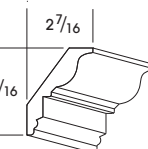
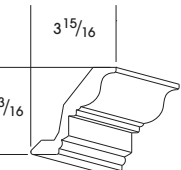
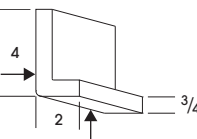
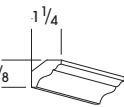
	SKU	Cubes	Standard Availability	Complements Paint Availability
SMALL CROWN				
 <ul style="list-style-type: none"> • Crown Moulding • 8 feet long • Available in all colors 	SMCROWN214	0.1	✓	✓
SMALL CROWN - TOP MOUNT				
 <ul style="list-style-type: none"> • Top Mount Crown Moulding • Seated on top of cabinet with 3/8" top nailing flange • 8 feet long • Available in all colors 	SSMCROWN214	0.1	✓	✓
LARGE CROWN				
 <ul style="list-style-type: none"> • Crown Moulding • 8 feet long • Available in all colors 	LGCROWN4	0.1	✓	✓
LARGE CROWN - TOP MOUNT				
 <ul style="list-style-type: none"> • Top Mount Crown Moulding • 8 feet long • Available in all colors 	SLGCROWN4	0.1	✓	✓
STARTER CROWN				
 <ul style="list-style-type: none"> • 4" Starter Crown Moulding; not finished on back • Arrows identify finished sides • 8 feet long • Available in all colors 	STCROWN	0.1	✓	✓
COVE CROWN				
 <ul style="list-style-type: none"> • 1 1/4" Cove Crown Moulding • 8 feet long • Available in all colors 	CCROWN134	0.1	✓	✓

Mouldings

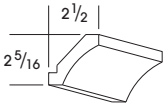
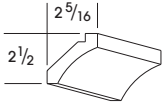
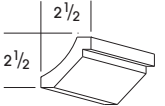
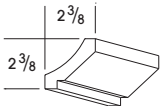
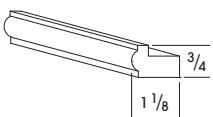
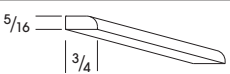
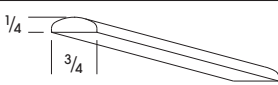
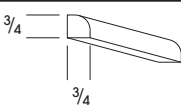
	SKU	cubes	Standard Availability	Complements Paint Availability	
REVERSIBLE CROWN					
 <p>Cove-Fo</p>  <p>Cove-So</p>  <p>Shaker-Fo</p>  <p>Shaker-Fo</p>	<ul style="list-style-type: none"> • 4-way adjustable Cove and Shaker Moulding combo • 8 feet long • Available in all colors 	REVCROWN	0.1	✓	✓
LIGHT RAIL					
	<ul style="list-style-type: none"> • Light Rail Moulding • 8 feet long • Available in all colors 	MLR	0.1	✓	✓
SCRIBE					
	<ul style="list-style-type: none"> • Scribe Moulding • 8 feet long • Available in all colors 	MSW	0.1	✓	✓
BATTEN					
	<ul style="list-style-type: none"> • Batten Moulding • 8 feet long • Available in all colors 	MBAT	0.1	✓	✓
QUARTER ROUND					
	<ul style="list-style-type: none"> • Quarter Round Moulding • 8 feet long • Available in all colors 	MQR	0.1	✓	✓

Mouldings

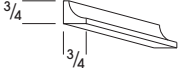
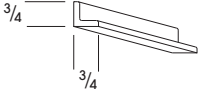
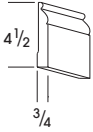
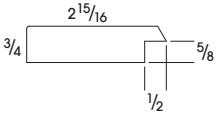
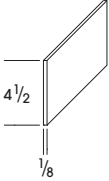
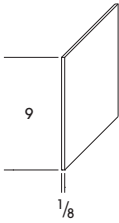
	SKU	Cubes	Standard Availability	Complements Paint Availability
INSIDE CORNER				
 <ul style="list-style-type: none"> • Inside Corner Moulding • 8 feet long • Available in all colors 	MICW	0.1	✓	✓
OUTSIDE CORNER				
 <ul style="list-style-type: none"> • Outside Corner Moulding • 8 feet long • Available in all colors 	MOCW	0.1	✓	✓
FURNITURE BASE				
 <ul style="list-style-type: none"> • 4 1/2" Furniture Base Moulding • 8 feet long • Available in all colors 	FB	0.1	✓	✓
MIRROR MOLDING				
 <ul style="list-style-type: none"> • Moulding has a Dartmouth profile • 8 feet long • Available in all colors 	MMIR	0.1	✓	✓
TOEKICK - 4 1/2"				
 <ul style="list-style-type: none"> • 4 1/2" Toekick (Plywood w/vinyl veneer) • 8 feet long • Available in all colors 	TOEKICK	0.1	✓	✓
TOEKICK - 9"				
 <ul style="list-style-type: none"> • 9" Toekick (Available as KAT single) • 8 feet long • Available in all colors 	TOEKICKADA	0.1	✓	✓

Hardware

IN STOCK

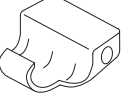
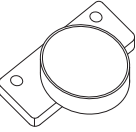
	SKU	cubes	Availability
HINGE ANGLE RESTRICTION CLIP			
 <ul style="list-style-type: none"> • Reduces door swing from 108° to 85° • Requires door removal for installation • Installs onto hinge in closed position 	HINGECLIP	0.1	✓
HINGE CAP			
 <ul style="list-style-type: none"> • Covers 35mm hinge holes • Used with door mounted Storage Solution pull-outs • Plastic HINGECAPWH - White HINGECAPAL - Almond HINGECAPBR - Brown 	HINGECAPWH	0.1	✓
	HINGECAPAL	0.1	✓
	HINGECAPBR	0.1	✓

Hardware



SOFHINGE



SCDOOR



BCGLIDEG & VCGLIDEG



CGUNIVSOCKETG

• Replacement parts for individual rear sockets are not available. Please order BCGLIDE or VCGLIDE as appropriate.

		Description
BERDOORHINGE	1412981	Attaches door to cabinet frame on BER
BERDOORPLATE	1412982	Attaches door to cabinet frame on BER
BERPIANOHINGE	1412983	Attaches door to door on BER
BERPIANOPLATE	1412984	Attaches door to door on BER
BUMPERPAD	1236889	Bumper pads 72/sheet (clear)
FALSEFRONTCLIPS	1231138	Attachment clips for false drawer fronts (common on Vanity and sink bases)
ROLLERS	1231139	Roller clip to couple with false panel clips. Snaps into it.
FOHINGE6G	1915302	Standard hinge for Berwyn, Dartmouth, York, and Waverly (Does not have Integrated Soft Close)
HINGE6G	1915285	Replacement self-closing hinge (Does not have Integrated Soft Close)
PLASTICSHIMS	1231114	Used to close gapping on butt doors
SOFTHINGE6G	2445953	Standard Overlay Soft Close Hinge, 6 Way Adj – Used on Hanover. Also used on Full overlay Diagonal cabinets; WDC, WMDC, WEC and SCB
SOFTHINGEG	1915319	Integrated Soft Close hinge for Berwyn, Dartmouth, York, and Waverly only.
SCDOOR	1412980	Frame mounted mechanism (not a hinge) used to create a Soft Close motion on cabinets without a Soft Close hinge
SCREWS	1231140	Glide screws (drawer box or cabinet member)
SHCLIP	1206859	Shelf clip 0.2 (sold individually)
CGUNIVSOCKETG	2773946	Universal cabinet glide socket. Can be used on base and vanity base.
POSHARDWARE	1231129	2 spacers & 6 screws for POS kits. Included in POS, replacement item
POSGLIDEG	1915539	Set of glides for POS (rear socket sold separately)
POSSOCKETLG	1915370	POS socket only—left
POSSOCKETRG	1915387	POS socket only—right
UMDRWLOCKRG	1915421	Undermount drawer clip—right
UMDRWLOCKLG	1915404	Undermount drawer clip—left
UMBCGLIDEG	1915268	Full-extension glide for base cabinets - Set
UMVCGLIDEG	1915353	Full-extension glide for vanity cabinets - Set
VCGLIDEG	1915336	Non Soft Close Vanity cabinet glide (rear socket & plugs attached) - Set
BCGLIDEG	1915251	Non Soft Close Base cabinet glide (rear socket & plugs attached) - Set

FINISH	IN STOCK			SPECIAL ORDER		
	TOUCH-UP KITS	STAIN & PAINT	SPRAY	TOUCH-UP MARKER	FILL STICK	PUTTY
OPAL PAINT	3191545	3191564	3192300	3795572	3795591	3543792
PEWTER PAINT	3113189	3113208	3113209	3795567	3795586	3543787
WHITE PAINT	1207236	1236980	1418160	3795563	3795582	3543785
BAYSIDE	3266656	—	3266655	3795600	3795609	—
BISCAYNE	3266875	—	3266874	3795601	3795610	—
CAPE	4013047	—	4013046	4013048	4013049	—
CURRANT	4013051	—	4013050	4013052	4013053	—
EVERGREEN	4013055	—	4013054	4013056	4013057	—
GOLDLEAF	4013059	—	4013058	4013060	4013061	—
JUNIPER	3522440	—	3522439	3795606	3795615	—
LAUREL	3522659	—	3522658	3795607	3795616	—
MIDNIGHT	3267094	—	3267093	3795602	3795611	—
PALMETTO	3267313	—	3267312	3795603	3795612	—
SEABREEZE	3267532	—	3267531	3795604	3795613	—
SEAPORT	3267751	—	3267750	3795605	3795614	—
SILHOUTTE	4013063	—	4013062	4013064	4013065	—
STONEBROOK	3522878	—	3522877	3795608	3795617	—
BROWNSTONE	3036608	3036627	—	3795569	3795588	3543789
DARK SABLE	1414298	1414291	—	3795564	3795583	3543785
GREY STAIN	2870437	2870432	—	3795568	3795587	3543786
HAZELNUT	3948695	3948696	—	3948693	3948694	3948692
HONEY	1207234	1236978	—	3795562	3795581	3543779
TOP COAT	—	1414350	1915465	—	—	—

Special order Touch-up Markers and Fill sticks will be shipped direct.

Touch-up kits include 1 putty fill stick, 1 touch-up marker and 1 small bottle of top coat

Wolf pints of stain and paint are for touch up purposes only. When doing a color match for a larger project we recommend taking a door to a professional paint store to do a color match.

Wall Cabinets – 12" Deep

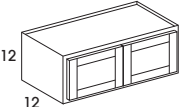
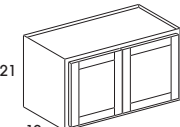
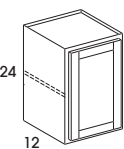
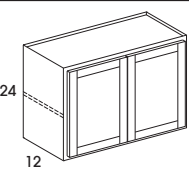
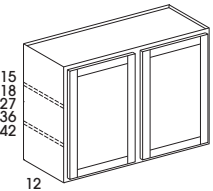
Design Tips: <ul style="list-style-type: none"> All single-door cabinets are hinged left Cabinets can be flipped during installation for right hinge applications Special Order items are not in stock and require a longer lead time to deliver 	SKU	Cubes	STANDARD				COMPLEMENTS PAINT		
			Hanover	Dartmouth	Dartmouth 5-piece York Waverly	Berwyn	Hanover Complements Paint	Dartmouth Complements Paint	Dartmouth 5-piece York Waverly Complements Paint
WALL – 12" HIGH – 12" DEEP									
 <ul style="list-style-type: none"> Two butt doors Shelves not available Available width: 39" 	W3912	4.0	✓	✓	✓	✓	✓	✓	✓
WALL – 21" HIGH – 12" DEEP									
 <ul style="list-style-type: none"> Two butt doors Shelves not available Available width: 30" 	W3021	3.5	✓	✓	✓	✓	✓	✓	✓
WALL – 24" HIGH – 12" DEEP									
 <ul style="list-style-type: none"> Single door One adjustable shelf Available width: 21" 	W2124	4.0	✓	✓	✓	✓	✓	✓	✓
 <ul style="list-style-type: none"> Two butt doors One adjustable shelf Available width: 33" 	W3324	6.0	✓	✓	✓	✓	✓	✓	✓
WALL – 39" WIDE – 12" DEEP									
 <ul style="list-style-type: none"> Two doors, cabinet with center stile 15" and 18" high - shelves not available 27" high - one adjustable shelf 36" and 42" high - three adjustable shelves Available width: 39" 	W3915	4.0	✓	✓	✓	✓	✓	✓	✓
	W3918	5.0	✓	✓	✓	✓	✓	✓	✓
	W3927	8.0	✓	✓	✓	✓	✓	✓	✓
	W3936	10.0	✓	✓	✓	✓	✓	✓	✓
	W3942	12.0	✓	✓	✓	✓	✓	✓	✓

Wall Cabinets — 15" and 24" Deep

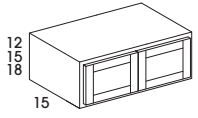
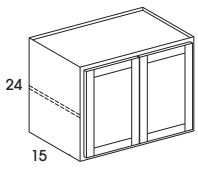
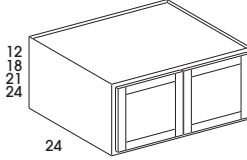
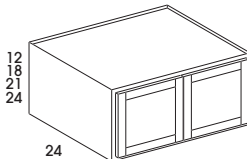
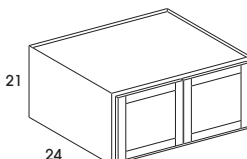
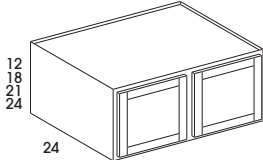
Design Tips: • Special Order items are not in stock and require a longer lead time to deliver		SKU	cubes	STANDARD				COMPLEMENTS PAINT			
				Hanover	Dartmouth	Dartmouth 5-piece York Waverly	Berwyn	Hanover Complements Paint	Dartmouth Complements Paint	Dartmouth 5-piece York Waverly Complements Paint	
WALL - 15" DEEP											
 <ul style="list-style-type: none"> • Two butt doors • Shelves not available • Available widths: 30"-36" 	W301215	3.5	✓	✓	✓	✓	✓	✓	✓		
	W301515	4.5	✓	✓	✓	✓	✓	✓	✓		
	W301815	5.5	✓	✓	✓	✓	✓	✓	✓		
	W331215	3.5	✓	✓	✓	✓	✓	✓	✓		
	W331515	4.5	✓	✓	✓	✓	✓	✓	✓		
	W331815	5.5	✓	✓	✓	✓	✓	✓	✓		
	W361215	3.5	✓	✓	✓	✓	✓	✓	✓		
	W361515	4.5	✓	✓	✓	✓	✓	✓	✓		
W361815	5.5	✓	✓	✓	✓	✓	✓	✓			
WALL - 24" HIGH - 15" DEEP											
 <ul style="list-style-type: none"> • Two butt doors • One adjustable shelf • Available widths: 30" and 36" 	W302415	6.3	✓	✓	✓	✓	✓	✓			
	W362415	7.5	✓	✓	✓	✓	✓	✓			
REFRIGERATOR WALL - 24" DEEP											
 <ul style="list-style-type: none"> • Two butt doors • Shelves not available in 12", 18", or 21" high • 24" high cabinets include one adjustable shelf • Available width: 30" 	RW3012	6.0	✓	✓	✓	✓	✓	✓			
	RW3018	9.0	✓	✓	✓	✓	✓	✓			
	RW3021	10.0	✓	✓	✓	✓	✓	✓			
	RW3024	12.0	✓	✓	✓	✓	✓	✓			
 <ul style="list-style-type: none"> • Two butt doors • Shelves not available in 12", 18", or 21" high • 24" high cabinets include one adjustable shelf • Available width: 33" • *Berwyn, Dartmouth, York, and Waverly also available In Stock 	RW3312*	6.0	✓	✓	✓	✓	✓	✓			
	RW3318*	9.0	✓	✓	✓	✓	✓	✓			
	RW3321*	10.0	✓	✓	✓	✓	✓	✓			
	RW3324*	12.0	✓	✓	✓	✓	✓	✓			
 <ul style="list-style-type: none"> • Two butt doors • Shelves not available • Available width: 36" • *Berwyn, Dartmouth, York, and Waverly also available In Stock 	RW3621*	10.0	✓	✓	✓	✓	✓	✓			
 <ul style="list-style-type: none"> • Two doors, cabinet with center stile • Shelves not available • Available width: 39" 	RW3912	7.0	✓	✓	✓	✓	✓	✓			
	RW3918	10.0	✓	✓	✓	✓	✓	✓			
	RW3921	11.0	✓	✓	✓	✓	✓	✓			
	RW3924	13.0	✓	✓	✓	✓	✓	✓			

Wall Cabinets – 12" Deep

Design Tips:

- All single-door cabinets are hinged left
- Cabinets can be flipped during installation for right hinge applications
- **Special Order items are not in stock and require a longer lead time to deliver**

SKU	cubes	STANDARD				COMPLEMENTS PAINT		
		Hanover	Dartmouth	Dartmouth 5-piece York Waverly	Berwyn	Hanover Complements Paint	Dartmouth Complements Paint	Dartmouth 5-piece York Waverly Complements Paint

WALL WITH DOORS PREPPED FOR GLASS – 12" DEEP

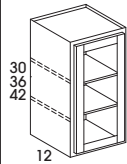

- **Standard cabinets have matching interior and exterior, including top and bottom**
- **Color Complements will have white interior and shelves. Top and bottom will match complement color**
- Single door
- 30" high - two adjustable shelves
- 36" and 42" high - three adjustable shelves
- 90° flat-front shelves are edge banded to match interior
- Glass and glass clips are not included
- Please order glass after receipt of product to ensure proper fit
- Doors can receive up to 3/16" thick glass
- Available widths: 15"-21"
- **NOTE: Waverly Prepped for Glass not available**

WMD1530	4.0	✓	✓	✓	✓	✓	✓	✓
WMD1830	4.0	✓	✓	✓	✓	✓	✓	✓
WMD2130	4.0	✓	✓	✓	✓	✓	✓	✓
WMD1536	4.0	✓	✓	✓	✓	✓	✓	✓
WMD1836	5.0	✓	✓	✓	✓	✓	✓	✓
WMD2136	5.0	✓	✓	✓	✓	✓	✓	✓
WMD1542	5.0	✓	✓	✓	✓	✓	✓	✓
WMD1842	6.0	✓	✓	✓	✓	✓	✓	✓
WMD2142	6.0	✓	✓	✓	✓	✓	✓	✓

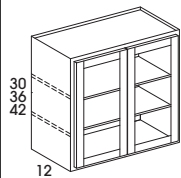

- **Standard cabinets have matching interior and exterior, including top and bottom**
- **Color Complements will have white interior and shelves. Top and bottom will match complement color**
- Two butt doors
- 30" high - two adjustable shelves
- 36" and 42" high - three adjustable shelves
- 90° flat-front shelves are edge banded to match interior
- Glass and glass clips are not included
- Please order glass after receipt of product to ensure proper fit
- Doors can receive up to 3/16" thick glass
- Available widths: 24"-30"
- ***Berwyn, Dartmouth, York, and Waverly also available In Stock**
- **NOTE: Waverly Prepped for Glass not available**

WMD2430DD	5.0	✓	✓	✓	✓	✓	✓	✓
WMD2730	5.0	✓	✓	✓	✓	✓	✓	✓
WMD3030*	7.0	✓	✓	✓	✓	✓	✓	✓
WMD3630	8.0	✓	✓	✓	✓	✓	✓	✓
WMD2436DD	6.0	✓	✓	✓	✓	✓	✓	✓
WMD2736	6.0	✓	✓	✓	✓	✓	✓	✓
WMD3036*	8.0	✓	✓	✓	✓	✓	✓	✓
WMD3636	9.0	✓	✓	✓	✓	✓	✓	✓
WMD2442DD	7.0	✓	✓	✓	✓	✓	✓	✓
WMD2742	7.0	✓	✓	✓	✓	✓	✓	✓
WMD3042*	9.0	✓	✓	✓	✓	✓	✓	✓
WMD3642	11.0	✓	✓	✓	✓	✓	✓	✓

Wall Cabinets – 12" and 15" Deep

Design Tips: • All single-door cabinets are hinged left • Cabinets can be flipped during installation for right hinge applications • Special Order items are not in stock and require a longer lead time to deliver	SKU	cubes	STANDARD				COMPLEMENTS PAINT			
			Hanover	Dartmouth	Dartmouth 5-piece York Waverly	Berwyn	Hanover Complements Paint	Dartmouth Complements Paint	Dartmouth 5-piece York Waverly Complements Paint	

DIAGONAL CORNER WALL WITH DOOR PREPPED FOR GLASS – 12" DEEP

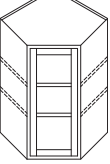
 <ul style="list-style-type: none"> • Standard cabinets have matching interior and exterior, including top and bottom • Color Complements will have white interior and shelves. Top and bottom will match complement color • Single door • 30" high - two adjustable shelves • 36" and 42" high - three adjustable shelves • 90° flat-front shelves are edge banded to match interior • Glass and glass clips are not included • Please order glass after receipt of product to ensure proper fit • Doors can receive up to 3/16" thick glass • Available width: 24" 	WMDC2430	10.0	✓	✓	✓	✓	✓	✓	✓
	WMDC2436	12.0	✓	✓	✓	✓	✓	✓	✓
	WMDC2442	14.0	✓	✓	✓	✓	✓	✓	✓

DIAGONAL CORNER WALL WITH DOOR PREPPED FOR GLASS – 15" DEEP

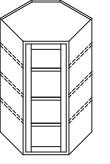
 <ul style="list-style-type: none"> • Standard cabinets have matching interior and exterior, including top and bottom • Color Complements will have white interior and shelves. Top and bottom will match complement color • Single door • 36" and 42" high - three adjustable shelves • 90° flat-front shelves are edge banded to match interior • Glass and glass clips are not included • Please order glass after receipt of product to ensure proper fit • Doors can receive up to 3/16" thick glass • Available width: 27" 	WMDC2736	16.0	✓	✓	✓	✓	✓	✓	✓
	WMDC2742	18.0	✓	✓	✓	✓	✓	✓	✓

WALL END CABINET – 12" DEEP

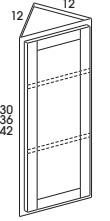
 <ul style="list-style-type: none"> • Single door • 30" high - two adjustable shelves • 36" and 42" high - three adjustable shelves • Available width: 12" 	WEC1230	3.0	✓	✓	✓	✓	✓	✓	✓
	WEC1236	3.0	✓	✓	✓	✓	✓	✓	✓
	WEC1242	4.0	✓	✓	✓	✓	✓	✓	✓

DIAGONAL CORNER WALL – 15" DEEP

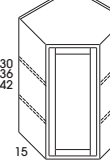
 <ul style="list-style-type: none"> • Single door • 30" high - two adjustable shelves • 36" and 42" high - three adjustable shelves • Available width: 27" 	WDC2736	16.0	✓	✓	✓	✓	✓	✓	✓
	WDC2742	18.0	✓	✓	✓	✓	✓	✓	✓

Wall Cabinets – 12" Deep

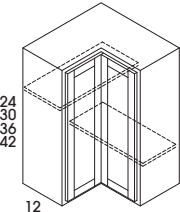
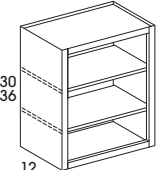
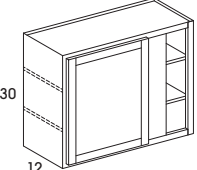
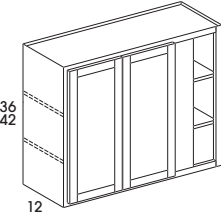
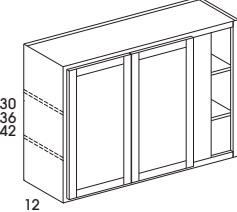
Design Tips: • Special Order items are not in stock and require a longer lead time to deliver	SKU	cubes	STANDARD				COMPLEMENTS PAINT			
			Hanover	Dartmouth	Dartmouth 5-piece York Waverly	Berwyn	Hanover Complements Paint	Dartmouth Complements Paint	Dartmouth 5-piece York Waverly Complements Paint	
WALL EASY REACH – 12" DEEP										
 <ul style="list-style-type: none"> • Bifold doors • 24" high - one rectangular adjustable shelf • 30" high - two rectangular adjustable shelves • 36" and 42" high - three rectangular adjustable shelves • Soft Close not available • Available width: 24" <p>*Berwyn, Dartmouth, York, and Waverly also available In Stock</p>	WER2424	8.0	✓	✓	✓	✓	✓	✓	✓	
	WER2430*	10.0	✓	✓	✓	✓	✓	✓	✓	
	WER2436*	12.0	✓	✓	✓	✓	✓	✓	✓	
	WER2442*	14.0	✓	✓	✓	✓	✓	✓	✓	
BOOKCASE CABINET – 12" DEEP										
 <ul style="list-style-type: none"> • No door • Matching Interior • 30" high - two adjustable shelves • 36" high - three adjustable shelves • Available widths: (30" high) 15"-36" (36" high) 24" 	BK1530	4.0	✓	✓	✓	✓	N/A	N/A	N/A	
	BK2130	5.0	✓	✓	✓	✓	N/A	N/A	N/A	
	BK3630	8.0	✓	✓	✓	✓	N/A	N/A	N/A	
	BK2436	6.0	✓	✓	✓	✓	N/A	N/A	N/A	
WALL CORNER – 12" DEEP										
 <ul style="list-style-type: none"> • One door • Hinged Left • 30" high - two adjustable shelves • Blind cabinets can be pulled 3" • Blind opening is 7" on all sizes • Does not include filler • Available width: 36" 	WC3630	8.0	✓	✓	✓	✓	✓	✓	✓	
	 <ul style="list-style-type: none"> • Two butt doors • 36" and 42" high - three adjustable shelves • Blind cabinets can be pulled 3" • Blind opening is 7" on all sizes • Does not include filler • Available width: 42" 	WC4236	12.0	✓	✓	✓	✓	✓	✓	✓
		WC4242	12.0	✓	✓	✓	✓	✓	✓	✓
 <ul style="list-style-type: none"> • Two butt doors • 30" high - two adjustable shelves • 36" and 42" high - three adjustable shelves • Blind cabinets can be pulled 3" • Blind opening is 7" on all sizes • Does not include filler • Available width: 48" 	WC4830	10.0	✓	✓	✓	✓	✓	✓	✓	
	WC4836	12.0	✓	✓	✓	✓	✓	✓	✓	
	WC4842	14.0	✓	✓	✓	✓	✓	✓	✓	

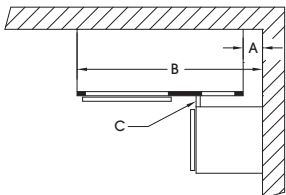

SKU	Cabinet Width	Blind Opening	Center Stile	A			B			C
				Minimum		Maximum	Minimum		Maximum	
				SO	FO		SO	FO		
WC36_ _	36"	7"	6"	0"	0"	3 1/2"	36"	36"	39 1/2"	N/A
WC42_ _	42"						42"	42"	45 1/2"	
WC48_ _	48"						48"	48"	51 1/2"	

A = Pull distance from wall
B = Cabinet distance from wall
C = Minimum filler width
SO = Standard Overlay (Hanover)
FO = Full Overlay (Berwyn, Dartmouth, York, Waverly)

Note: Blind openings are right side: cabinet will be flipped during installation for left blind applications.

Base Cabinets – 24" Deep

Design Tips: • All single-door cabinets are hinged left • Doors will be reversed during installation for right hinge applications • Special Order items are not in stock and require a longer lead time to deliver	SKU	cubes	STANDARD				COMPLEMENTS PAINT			
			Hanover	Dartmouth	Dartmouth 5-piece York Waverly	Berwyn	Hanover Complements Paint	Dartmouth Complements Paint	Dartmouth 5-piece York Waverly Complements Paint	

BASE – 34 1/2" HIGH – 24" DEEP

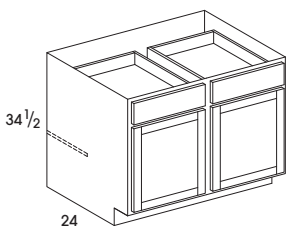
 <ul style="list-style-type: none"> • Two doors, cabinet with center stile • Two drawers • One adjustable half-depth shelf • Available widths: 45" and 48" 	B45	22.0	✓	✓	✓	✓	✓	✓	✓
	B48	23.0	✓	✓	✓	✓	✓	✓	✓

BASE WITH FULL HEIGHT DOORS – 34 1/2" HIGH – 24" DEEP

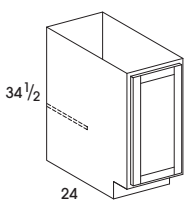
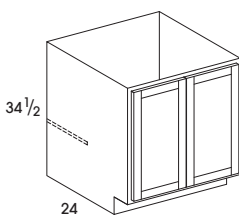
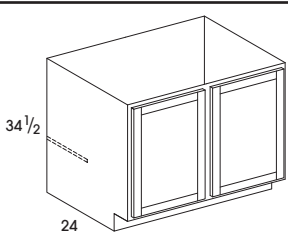
 <ul style="list-style-type: none"> • One full height door • One adjustable half-depth shelf • Available widths: 12"-21" 	B12FH	6.0	✓	✓	✓	✓	✓	✓	✓
	B15FH	8.0	✓	✓	✓	✓	✓	✓	✓
	B18FH	9.0	✓	✓	✓	✓	✓	✓	✓
	B21FH	11.0	✓	✓	✓	✓	✓	✓	✓
 <ul style="list-style-type: none"> • Two full height butt doors • One adjustable half-depth shelf • Available widths: 24"-36" 	B24DDFH	12.0	✓	✓	✓	✓	✓	✓	✓
	B27FH	13.0	✓	✓	✓	✓	✓	✓	✓
	B30FH	15.0	✓	✓	✓	✓	✓	✓	✓
	B33FH	16.0	✓	✓	✓	✓	✓	✓	✓
	B36FH	18.0	✓	✓	✓	✓	✓	✓	✓
 <ul style="list-style-type: none"> • Two doors, cabinet with center stile • One adjustable half-depth shelf • Available widths: 39" and 42" 	B39FH	20.0	✓	✓	✓	✓	✓	✓	✓
	B42FH	21.0	✓	✓	✓	✓	✓	✓	✓

SINK BASE WITH FULL HEIGHT DOORS – 34 1/2" HIGH – 24" DEEP

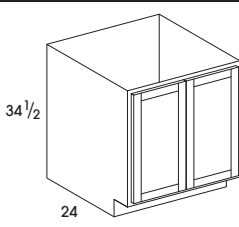
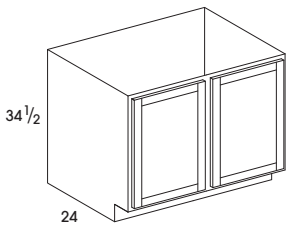
 <ul style="list-style-type: none"> • Two full height butt doors • Available widths: 27"-36" 	SB27FH	13.0	✓	✓	✓	✓	✓	✓	✓
	SB30FH	15.0	✓	✓	✓	✓	✓	✓	✓
	SB33FH	16.0	✓	✓	✓	✓	✓	✓	✓
	SB36FH	18.0	✓	✓	✓	✓	✓	✓	✓
 <ul style="list-style-type: none"> • Two doors, cabinet with center stile • Available width: 42" 	SB42FH	21.0	✓	✓	✓	✓	✓	✓	✓

Base Cabinets – 24" Deep

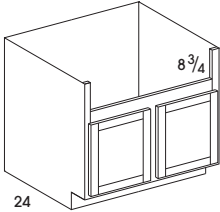
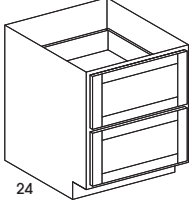
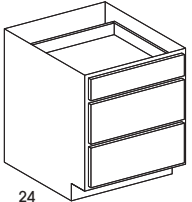
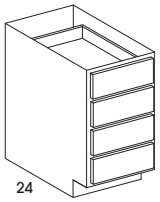
Design Tips: • Special Order items are not in stock and require a longer lead time to deliver		SKU	cubes	STANDARD				COMPLEMENTS PAINT		
				Hanover	Dartmouth	Dartmouth 5-piece York Waverly	Berwyn	Hanover Complements Paint	Dartmouth Complements Paint	Dartmouth 5-piece York Waverly Complements Paint
BASE FARM SINK – 34 1/2" HIGH – 24" DEEP										
	<ul style="list-style-type: none"> • 30" and 33" - two butt doors • 39" and 42" - two doors, cabinet with center stile • Opening is 3" less than total width of cabinet and 8 3/4" high • Maximum cut out height: Standard overlay = 11" Full overlay = 10" • Available widths: 30"-42" <p>*Berwyn, Dartmouth, York, and Waverly also available In Stock</p>	FSB30	15.0	✓	✓	✓	✓	✓	✓	✓
		FSB33	16.0	✓	✓	✓	✓	✓	✓	✓
		FSB36*	18.0	✓	✓	✓	✓	✓	✓	✓
		FSB39	19.0	✓	✓	✓	✓	✓	✓	✓
		FSB42	21.0	✓	✓	✓	✓	✓	✓	✓
TWO DRAWER BASE – 34 1/2" HIGH – 24" DEEP										
	<ul style="list-style-type: none"> • Two drawers • Drawer fronts will be 5-piece for all door styles • Available widths: 27"-36" 	DB27D2	13.0	✓	✓	✓	✓	✓	✓	✓
		DB30D2	15.0	✓	✓	✓	✓	✓	✓	✓
		DB36D2	18.0	✓	✓	✓	✓	✓	✓	✓
THREE DRAWER BASE – 34 1/2" HIGH – 24" DEEP										
	<ul style="list-style-type: none"> • Three drawers • Available width: 27" 	DB27D3	13.0	✓	✓	✓	✓	✓	✓	✓
FOUR DRAWER BASE – 34 1/2" HIGH – 24" DEEP										
	<ul style="list-style-type: none"> • Four drawers • Available widths: 12"-24" 	DB12D4	6.0	✓	✓	✓	✓	✓	✓	✓
		DB15D4	8.0	✓	✓	✓	✓	✓	✓	✓
		DB18D4	9.0	✓	✓	✓	✓	✓	✓	✓
		DB21D4	11.0	✓	✓	✓	✓	✓	✓	✓
		DB24D4	12.0	✓	✓	✓	✓	✓	✓	✓

Base Cabinets – 24" Deep

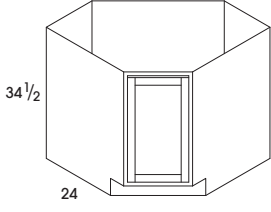
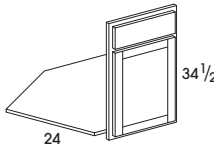
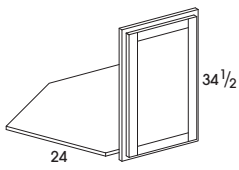
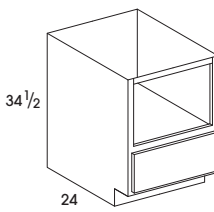
Design Tips: <ul style="list-style-type: none"> All single-door cabinets are hinged left Doors will be reversed during installation for right hinge applications Special Order items are not in stock and require a longer lead time to deliver 	SKU	cubes	STANDARD				COMPLEMENTS PAINT			
			Hanover	Dartmouth	Dartmouth 5-piece York Waverly	Berwyn	Hanover Complements Paint	Dartmouth Complements Paint	Dartmouth 5-piece York Waverly Complements Paint	
CORNER SINK BASE WITH FULL HEIGHT DOOR – 34 1/2" HIGH – 24" DEEP										
 <ul style="list-style-type: none"> One full height door Full cabinet 	SCB36FH	26.0	✓	✓	✓	✓	✓	✓	✓	
	SCB42FH	34.0	✓	✓	✓	✓	✓	✓	✓	
CORNER SINK FACE FRAME AND DOOR – 34 1/2" HIGH – 24" DEEP										
 <ul style="list-style-type: none"> Single door One false panel Face frame and floor only 	SCB36FF	1.0	✓	✓	✓	✓	✓	✓	✓	
CORNER SINK FACE FRAME WITH FULL HEIGHT DOOR – 34 1/2" HIGH – 24" DEEP										
 <ul style="list-style-type: none"> One full height door Face frame and floor only 	SCB36FFFH	1.0	✓	✓	✓	✓	✓	✓	✓	
BASE MICROWAVE CABINET – 34 1/2" HIGH – 24" DEEP										
 <ul style="list-style-type: none"> Standard cabinets have matching interior in shelf area Color Complements will have white interior in shelf area Opening: 27" wide x 16" high One lower drawer Available widths: 27" and 30" *Berwyn, Dartmouth, York, and Waverly also available In Stock 	BMW27	13.0	✓	✓	✓	✓	✓	✓	✓	
	BMW30*	15.0	✓	✓	✓	✓	✓	✓	✓	

Base Cabinets – 24" Deep

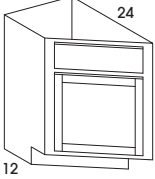
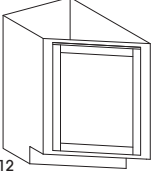
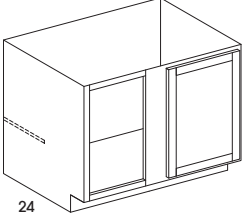
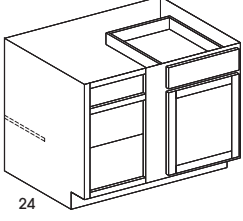
Design Tips: <ul style="list-style-type: none"> All single-door cabinets are hinged left Doors will be reversed during installation for right hinge applications Special Order items are not in stock and require a longer lead time to deliver 	SKU	cubes	STANDARD				COMPLEMENTS PAINT		
			Hanover	Dartmouth	Dartmouth 5-piece York Waverly	Berwyn	Hanover Complements Paint	Dartmouth Complements Paint	Dartmouth 5-piece York Waverly Complements Paint
BASE END CABINET – 34 1/2" HIGH – 12" DEEP									
 <ul style="list-style-type: none"> One door One false panel Choose right or left hand Hinge is always on 12" deep side of cabinet BEC12L shown in illustration Available width: 12" 	BEC12L	6.0	✓	✓	✓	✓	✓	✓	✓
	BEC12R	6.0	✓	✓	✓	✓	✓	✓	✓
BASE END CABINET WITH FULL HEIGHT DOOR – 34 1/2" HIGH – 12" DEEP									
 <ul style="list-style-type: none"> One full height door Choose right or left hand Hinge is always on the 12" deep side of cabinet BEC12LFH shown in illustration Available width: 12" 	BEC12LFH	6.0	✓	✓	✓	✓	✓	✓	✓
	BEC12RFH	6.0	✓	✓	✓	✓	✓	✓	✓
BASE CORNER WITH FULL HEIGHT DOOR – 34 1/2" HIGH – 24" DEEP									
 <ul style="list-style-type: none"> One full height door One adjustable half-depth shelf Center stile is 6" wide Does not include filler Available widths: 36"-42" 	BC36FH	18.0	✓	✓	✓	✓	✓	✓	✓
	BC39FH	20.0	✓	✓	✓	✓	✓	✓	✓
	BC42FH	21.0	✓	✓	✓	✓	✓	✓	✓
BASE CORNER – 34 1/2" HIGH – 24" DEEP									
 <ul style="list-style-type: none"> One door One drawer One adjustable half-depth shelf Center stile is 6" Does not include filler Available widths: 39" and 45" 	BC39	17.0	✓	✓	✓	✓	✓	✓	✓
	BC45	19.0	✓	✓	✓	✓	✓	✓	✓

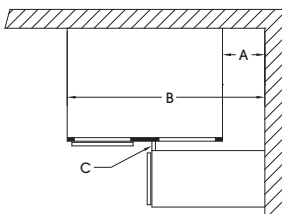

SKU	Cabinet Width	Blind Opening	Center Stile	A			B			C
				Minimum		Maximum	Minimum		Maximum	
				SO	FO		SO	FO		
BC36FH	27"	9"	6"	9 1/4"	10 1/2"	13 1/2"	36 3/4"	37 1/2"	40 1/2"	7/8"
BC39/FH	30"	10 1/2"		8 3/4"	9"	12"	38 1/4"	39"	42"	
BC42FH	36"	13 1/2"		5 1/4"	6"	9"	41 1/4"	42"	45"	
BC45	42"	16 1/2"		2 1/4"	3"	6"	44 1/4"	45"	48"	

A = Pull distance from wall
 B = Cabinet distance from wall
 C = Minimum filler width

SO = Standard Overlay (Hanover)
 FO = Full Overlay (Berwyn, Dartmouth, York, Waverly)

Minimum filler width requirement (C) based on 7/8" high hardware

Note: Blind openings are right side: door and drawer can be reversed during installation for left blind application.

Tall Cabinets – 24" Deep

Design Tips: • Special Order items are not in stock and require a longer lead time to deliver	SKU	cubes	STANDARD				COMPLEMENTS PAINT		
			Hanover	Dartmouth	Dartmouth 5-piece York Waverly	Berwyn	Hanover Complements Paint	Dartmouth Complements Paint	Dartmouth 5-piece York Waverly Complements Paint

OVEN CABINET – 24" DEEP

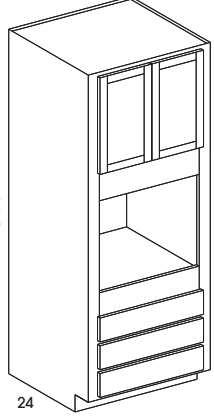

- Two butt doors
- No shelves included in upper cabinet
- If desired order OCSHELF below for 90" and 96" tall oven cabinets
- Inside opening is natural/white
- Three bottom drawers
- Two top drawers may be removed and cut to create a Double Oven opening
- Oven cabinet has a 3" left and right stile running the entire height of the cabinet
- Rail below upper cabinet is 6" high and can be trimmed or removed for an opening height up to 33 1/4"
- Maximum cut out for the width is 31"
- Dartmouth, and York doors and drawers are not full overlay
- Available width: 33"

***Berwyn, Dartmouth, York, and Waverly also available In Stock**

SKU	Height	Hanover	Dartmouth	Dartmouth 5-piece York Waverly	Berwyn	Hanover Complements Paint	Dartmouth Complements Paint	Dartmouth 5-piece York Waverly Complements Paint
OC338424*	39.0	✓	✓	✓	✓	✓	✓	✓
OC339024*	42.0	✓	✓	✓	✓	✓	✓	✓
OC339624*	44.0	✓	✓	✓	✓	✓	✓	✓

Oven Cabinet		
SKU	Oven Opening	Upper Cabinet Opening
OC338424	27" wide x 24" high	27" wide x 18 3/4" high
OC339024	27" wide x 24" high	27" wide x 24 3/4" high
OC339624	27" wide x 24" high	27" wide x 30 3/4" high

DOUBLE OVEN – 24" DEEP



- Two butt doors
- No shelves included in upper cabinet
- If desired order OCSHELF below for 90" tall oven cabinets
- Inside opening is natural/white
- One drawer
- Oven opening: 47 1/4" high x 27" wide
- Rail below upper cabinets is 6" high and can be trimmed or removed for an opening height up to 53 1/4"
- Available width: 33"

SKU	Height	Hanover	Dartmouth	Dartmouth 5-piece York Waverly	Berwyn	Hanover Complements Paint	Dartmouth Complements Paint	Dartmouth 5-piece York Waverly Complements Paint
OCD338424	39.0	✓	✓	✓	✓	✓	✓	✓
OCD339024	42.0	✓	✓	✓	✓	✓	✓	✓

OVEN CABINET SHELF



- Full depth 3/4" shelf to add to the upper cabinet of 90" and 96" tall cabinet
- 22 3/16" x 31 3/16"
- Shelf clips must be ordered separately
- Available in white and natural maple

***Berwyn, Dartmouth, York, and Waverly also available In Stock**

SKU	Height	Hanover	Dartmouth	Dartmouth 5-piece York Waverly	Berwyn	Hanover Complements Paint	Dartmouth Complements Paint	Dartmouth 5-piece York Waverly Complements Paint
OC3324SHELF*	1.0	✓	✓	✓	✓	N/A	N/A	N/A

Tall Cabinets – 12" and 24" Deep

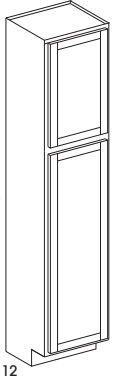
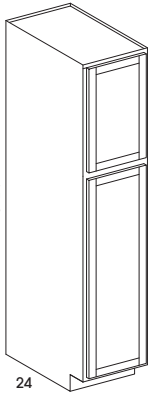
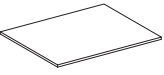
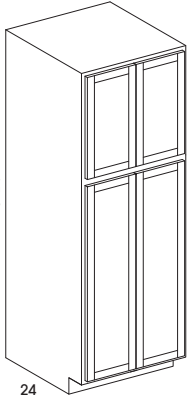
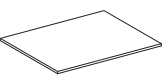
Design Tips: <ul style="list-style-type: none"> All single-door cabinets are hinged left Doors will be reversed during installation for right hinge applications Special Order items are not in stock and require a longer lead time to deliver 		SKU	cubes	STANDARD				COMPLEMENTS PAINT		
				Hanover	Dartmouth	Dartmouth 5-piece York Waverly	Berwyn	Hanover Complements Paint	Dartmouth Complements Paint	Dartmouth 5-piece York Waverly Complements Paint
UTILITY CABINET – 12" DEEP										
 <p>84 90 96</p> <p>12</p>	<ul style="list-style-type: none"> Two doors One fixed shelf between doors No shelves included in upper cabinet Unfinished toekick is attached to all utility cabinets Available width: 18" 	U188412	11.0	✓	✓	✓	✓	✓	✓	✓
		U189012	12.0	✓	✓	✓	✓	✓	✓	✓
		U189612	13.0	✓	✓	✓	✓	✓	✓	✓
UTILITY CABINET – 24" DEEP										
 <p>84 90 96</p> <p>24</p>	<ul style="list-style-type: none"> Two doors One fixed shelf between doors No shelves included in upper cabinet Unfinished toekick is attached to all utility cabinets Available width: 15" 	U158424	18.0	✓	✓	✓	✓	✓	✓	✓
		U159024	19.0	✓	✓	✓	✓	✓	✓	✓
		U159624	20.0	✓	✓	✓	✓	✓	✓	✓
UTILITY CABINET SHELF KIT										
	<ul style="list-style-type: none"> SHELFKIT includes 4 shelves and clips. 	U1812SHELFK	0.5	✓	✓	✓	✓	N/A	N/A	N/A
UTILITY CABINET – 24" DEEP										
 <p>84 90 96</p> <p>24</p>	<ul style="list-style-type: none"> Four butt doors Shelves not included Unfinished toekick is attached to all utility cabinets Available widths: 24"-36" 	U248424DD	28.0	✓	✓	✓	✓	✓	✓	✓
		U249024DD	30.0	✓	✓	✓	✓	✓	✓	✓
		U249624DD	32.0	✓	✓	✓	✓	✓	✓	✓
		U308424	35.0	✓	✓	✓	✓	✓	✓	✓
		U309024	38.0	✓	✓	✓	✓	✓	✓	✓
		U309624	40.0	✓	✓	✓	✓	✓	✓	✓
		U368424	42.0	✓	✓	✓	✓	✓	✓	✓
		U369024	46.0	✓	✓	✓	✓	✓	✓	✓
U369624	48.0	✓	✓	✓	✓	✓	✓	✓		
UTILITY CABINET KIT										
	<ul style="list-style-type: none"> SHELF includes single shelf only, no clips. 3024 shelf: 22" x 28". 3624 shelf: 22" x 34" 	U3024SHELF	1.0	✓	✓	✓	✓	N/A	N/A	N/A
		U3624SHELF	1.0	✓	✓	✓	✓	N/A	N/A	N/A

Vanity Cabinets – 16" and 18" Deep

Design Tips: • All single-door cabinets are hinged left • Doors will be reversed during installation for right hinge applications • Special Order items are not in stock and require a longer lead time to deliver	SKU	cubes	STANDARD				COMPLEMENTS PAINT			
			Hanover	Dartmouth	Dartmouth 5-piece York Waverly	Berwyn	Hanover Complements Paint	Dartmouth Complements Paint	Dartmouth 5-piece York Waverly Complements Paint	

VANITY SINK BASE – 34 1/2" HIGH – 16" DEEP

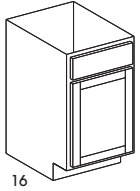
 <ul style="list-style-type: none"> • One door • One false panel • Available width: 18" 	VSB1816	6.0	✓	✓	✓	✓	✓	✓	✓

VANITY SINK BASE – 34 1/2" HIGH – 18" DEEP

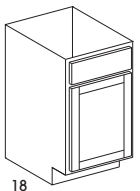
 <ul style="list-style-type: none"> • One door • One false panel • Available widths: 18" 	VSB1818	6.5	✓	✓	✓	✓	✓	✓	✓

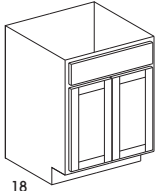
 <ul style="list-style-type: none"> • Two doors • One false panel • Available widths: 24"-36" 	VSB2418DD	9.0	✓	✓	✓	✓	✓	✓	✓
	VSB2718	10.0	✓	✓	✓	✓	✓	✓	✓
	VSB3018	11.0	✓	✓	✓	✓	✓	✓	✓
	VSB3318	12.0	✓	✓	✓	✓	✓	✓	✓
	VSB3618	13.0	✓	✓	✓	✓	✓	✓	✓

Vanity Cabinets – 21" Deep

Design Tips:

- All single-door cabinets are hinged left
- Doors will be reversed during installation for right hinge applications
- **Special Order items are not in stock and require a longer lead time to deliver**

SKU	cubes	STANDARD				COMPLEMENTS PAINT		
		Hanover	Dartmouth	Dartmouth 5-piece York Waverly	Berwyn	Hanover Complements Paint	Dartmouth Complements Paint	Dartmouth 5-piece York Waverly Complements Paint

VANITY SINK EIGHT DRAWER BASE – 34 1/2" HIGH – 21" DEEP

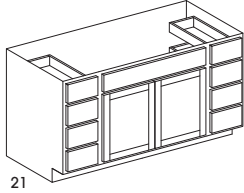



- Butt doors
- One false panel
- Eight drawers
- Outside drawer area is 12" wide
- Available width: 60"

VSB60DB8	26.0	✓	✓	✓	✓	✓	✓	✓
----------	------	---	---	---	---	---	---	---

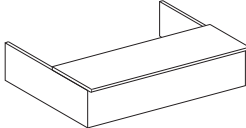
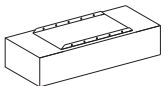
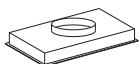
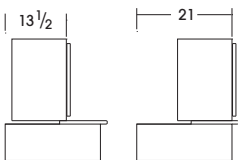
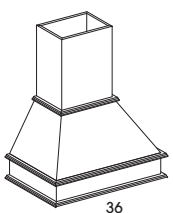
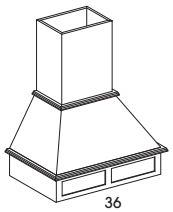
Box Hood / Wood Hoods

Design Tips: • Special Order items are not in stock and require a longer lead time to deliver		SKU	cubes	STANDARD				COMPLEMENTS PAINT		
				Hanover	Dartmouth	Dartmouth 5-piece York Waverly	Berwyn	Hanover Complements Paint	Dartmouth Complements Paint	Dartmouth 5-piece York Waverly Complements Paint
BOX HOOD										
 <p>Hood</p>  <p>Liner</p>  <p>Blower</p>  <p>Wall cabinet above box hood can be pulled 13 1/2" to 21" for creative design</p>	<p>Box Hood - 36" Wide</p> <ul style="list-style-type: none"> Includes hood, liner and blower (components cannot be ordered separately) Must have a cabinet placed above and requires field modifications for venting <p>Ventilation Module</p> <ul style="list-style-type: none"> Depending on installation depth, additional blocking may be required to mount the ventilation module Two-speed motor Rocker switch controls 6 5/8" Fan, 250 CFM, 8.0 Sones 7" round ducted or non-ducted discharge Enclosed light Accepts two incandescent max. 40-watt candelabra bulbs (not included) One-piece, washable aluminum mesh filter Durable, powder-coated silver finish One Year Limited Warranty <p>Ventilation Optional Accessories: (not available through Wolf)</p> <ul style="list-style-type: none"> Model 356NDK non-ducted recirculating kit (includes charcoal filter, soffit grille, 900 stack boot, and 7" round duct) Disposable charcoal filter kit part # B08999040 	BOXHOOD	4.0	✓	✓	✓	✓	✓	✓	✓
ANGLED WOOD HOOD WITH TRIMMABLE CHIMNEY										
 <p>36</p>	<ul style="list-style-type: none"> Includes hood, trimmable chimney, ventilator, liner and washable aluminum mesh filter (components cannot be ordered separately) Cabinet dimensions: 36" wide x 42" tall x 19" deep Overall Dimensions with moulding: 38 5/16" wide x 20 1/8" deep Ventilator: Broan, Nutone - Model PM250 (250 CFM) 	HOODA	19.0	✓	✓	✓	✓	✓	✓	✓
DELUXE WOOD HOOD WITH DECORATIVE VALANCE AND TRIMMABLE CHIMNEY										
 <p>36</p>	<ul style="list-style-type: none"> Includes hood, trimmable chimney, ventilator, liner and washable aluminum mesh filter (components cannot be ordered separately) Cabinet dimensions: 36" wide x 42" tall x 19" deep Overall Dimensions with moulding: 37 3/4" wide x 19 7/8" deep Ventilator: Broan, Nutone - Model PM250 (250 CFM) 	HOODD	19.0	✓	✓	✓	✓	✓	✓	✓

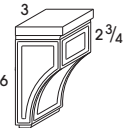
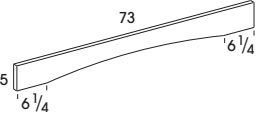
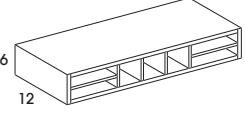
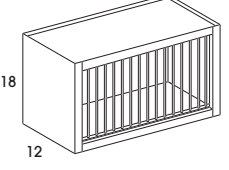
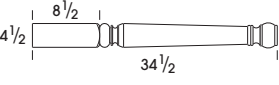
Accessories / Fillers

Design Tips: • Special Order items are not in stock and require a longer lead time to deliver	SKU	cubes	STANDARD				COMPLEMENTS PAINT		
			Hanover	Dartmouth	Dartmouth 5-piece York Waverly	Berwyn	Hanover Complements Paint	Dartmouth Complements Paint	Dartmouth 5-piece York Waverly Complements Paint
CORBEL									
 <ul style="list-style-type: none"> • 6" high x 3" wide" x 2 3/4" deep 	CORBEL	0.1	✓	✓	✓	✓	✓	✓	✓
ROMAN ARCH VALANCE									
 <ul style="list-style-type: none"> • All valances are 3/4" thick solid maple • Stained valances have a profiled edge • White valances have Dartmouth edge profile • Finished two sides; Front face and profiled edge • Available width: 73" 	V573RA	0.3	✓	✓	✓	✓	✓	✓	✓
ORGANIZER - 6" HIGH - 12" DEEP									
 <ul style="list-style-type: none"> • Matching interior • Unfinished ends • Mount unit between cabinets • Available width: 36" 	ORG36	2.0	✓	✓	✓	✓	N/A	N/A	N/A
PLATE RACK - 18" HIGH - 12" DEEP									
 <ul style="list-style-type: none"> • Matching interior • Unfinished ends • Available width: 30" 	PR30	4.0	✓	✓	✓	✓	N/A	N/A	N/A
LEG									
 <ul style="list-style-type: none"> • 34 1/2" high x 4 1/2" wide 	LEG	1.0	✓	✓	✓	✓	✓	✓	✓
FILLER - FLUTED									
 <ul style="list-style-type: none"> • Fillers are 3/4" thick solid maple • Fillers are finished on the face, left, and right sides; however, the sides receive a lesser finish • If you require an end to be exposed, we suggest using a valance • Available widths: 36" and 42" 	FWF336	0.1	✓	✓	✓	✓	N/A	N/A	N/A
	FWF342	0.1	✓	✓	✓	✓	N/A	N/A	N/A

Accessories / Mouldings

<p>Design Tips: <ul style="list-style-type: none"> Special Order items are not in stock and require a longer lead time to deliver </p>	SKU	cubes	Availability
------------------------------------------------------------------------------------------------------------------------------------------------------------	-----	-------	--------------

FULL DEPTH SHELF

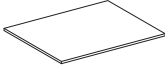
 <ul style="list-style-type: none"> Single shelf Additional full-depth shelf for cabinets that received the full depth modification Cabinets without full depth modification require additional holes drilled behind face frame at installation Shelf clips not included Shelf depth: 22³/₁₆" Available in White or Natural 	B1224SHELF	1.0	✓
	B1524SHELF	1.0	✓
	B1824SHELF	1.0	✓
	B2124SHELF	1.0	✓
	B2424SHELF	1.0	✓
	B2724SHELF	1.0	✓
	B3024SHELF	1.0	✓
	B3324SHELF	1.0	✓
	B3624SHELF	1.0	✓
	B4224SHELF	1.0	✓
	BC3624SHELF	1.0	✓
	BC4224SHELF	1.0	✓
	BC4824SHELF	1.0	✓

SPICE RACK PULL-OUT

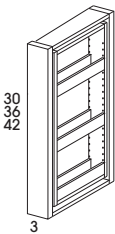
 <ul style="list-style-type: none"> WSPICE 30" - 3 shelves BSPICE - 2 shelves Must be installed between two cabinets Glides included Field applied filler is NOT included Order filler separately 	WSPICE3X30 3" x 30" x 11"	1.0	✓
	BSPICE3X30 3" x 30" x 23"	1.0	✓

ADA – Universal Design

ADA and Universal Design (UD) Specifications

Wolf Classic cabinets are offered in ADA-Compliant and Universal Design specifications for kitchen-at-a-time orders.

Available in all standard door styles and colors. Wolf's ADA and Universal Design cabinets are special order only and require a longer lead time to deliver. Please work with your Wolf Sales Consultant or Wolf Customer Care to determine your delivery date.



ADA

- 32½" Cabinet Height
- 9" High Toekick
- 9" Deep Toekick



Universal Design (UD)

- 32½" Cabinet Height
- 5½" High Toekick
- 4⅞" Deep Toekick

What is ADA Compliance vs. Universal Design?

ADA-compliant cabinets are designed to meet the needs of people with disabilities per the Americans with Disabilities Act. Wolf Classic offers ADA-compliant cabinetry with a reduced height and a taller and deeper toe-kick. However, it is important to note that just because ADA-compliant cabinetry is used, your design/project does not automatically become ADA compliant. ADA compliance is based on the overall height of the workspace, clear floor space, knee clearance and toe clearance combined. All of these elements must be applied together and accurately for your design to be considered ADA compliant.

Universal Design, also known as Aging in Place Design, is a much broader concept. The goal is to create an environment that is usable, to the greatest extent possible, by people of any age or ability without the need for a special design or adaptation. In order to be considered UD, your design must consider the space needed for approach, reach, manipulation and overall use regardless of the user's body size, posture or mobility.

Both of these design styles are concerned with addressing the needs of users beyond those considered to be "average" or "typical".

ADA COMPLIANT UNIVERSAL DESIGN SPECS

- 1 Cabinet fronts are made from ¾" solid maple wood. Rails are pocket drilled and assembled with 1¼" screws for rugged durability.
- 2 Side panels and bottom - ½" plywood with matching exterior laminate - glued and stapled in a ½" dado in the cabinet's front frame.
- 3 Back panels - made from vinyl-covered (inside only) ½" plywood - are glued and nailed in a ½" dado and stapled to the hang rail and cabinet bottom.
- 4 All-wood ¾" corner blocks are installed on all corners.
- 5 All Base cabinets are 32½" high.
- 6 Wolf Classic's ADA cabinets are designed to meet the Americans with Disabilities Act guidelines with a Toekick height of 9". Universal Design cabinets are constructed with a 5½" high toekick. Both ADA and UD cabinets are available in special order.

NOTES:

1. In order to maintain height compliance, cabinets must be placed on top of flooring rather than the floor butting up to the cabinet toe-kick.
2. ADA and UD bases do not include an interior shelf due to cabinet and toe-kick heights.

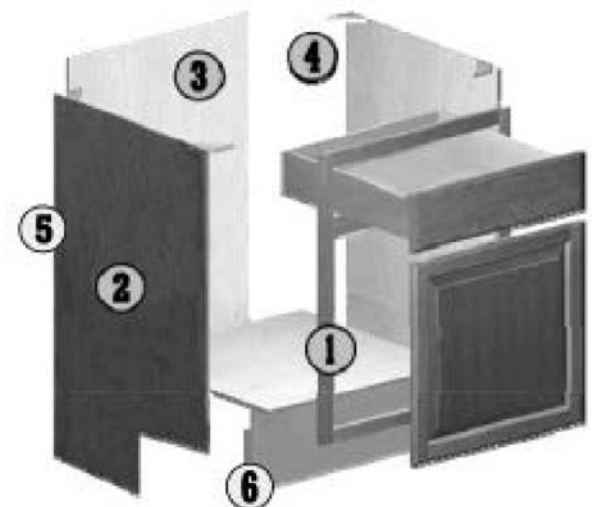

ADA Cabinets: Local codes may differ. Please confirm specifications with local code enforcement agencies prior to ordering. These items are non-returnable.

ADA Base Cabinets – 24" Deep

Design Tips: • Please confirm specifications with local code enforcement agencies prior to ordering; these items are non-returnable • All single-door cabinets are hinged left • Doors will be reversed during installation for right hinge applications • Special Order items are not in stock and require a longer lead time to deliver	SKU	cubes	STANDARD				COMPLEMENTS PAINT			
			Hanover	Dartmouth	Dartmouth 5-piece York Waverly	Berwyn	Hanover Complements Paint	Dartmouth Complements Paint	Dartmouth 5-piece York Waverly Complements Paint	

BASE CABINET – 32 1/2" HIGH – 24" DEEP

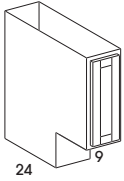
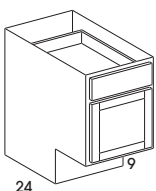
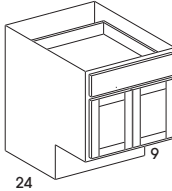
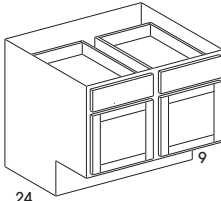
 <ul style="list-style-type: none"> • One full height door • Shelves not available • ADA Bases do not include an interior shelf due to the height and depth of the toekick • Toekick height: 9" • Available width: 9" 	B09FHADA	5.0	✓	✓	✓	✓	✓	✓	✓
 <ul style="list-style-type: none"> • Single door • One drawer • Shelves not available • ADA Bases do not include an interior shelf due to the height and depth of the toekick • Toekick height: 9" • Available widths: 12"-21" 	B12ADA	6.0	✓	✓	✓	✓	✓	✓	✓
	B15ADA	8.0	✓	✓	✓	✓	✓	✓	✓
	B18ADA	9.0	✓	✓	✓	✓	✓	✓	✓
	B21ADA	11.0	✓	✓	✓	✓	✓	✓	✓
 <ul style="list-style-type: none"> • Two butt doors • One drawer • Shelves not available • ADA Bases do not include an interior shelf due to the height and depth of the toekick • Toekick height: 9" • Available widths: 24"-36" 	B24DDADA	12.0	✓	✓	✓	✓	✓	✓	✓
	B27ADA	13.0	✓	✓	✓	✓	✓	✓	✓
	B30ADA	15.0	✓	✓	✓	✓	✓	✓	✓
	B33ADA	16.0	✓	✓	✓	✓	✓	✓	✓
	B36ADA	18.0	✓	✓	✓	✓	✓	✓	✓
 <ul style="list-style-type: none"> • Two doors, cabinet with center stile • Two drawers • Shelves not available • ADA Bases do not include an interior shelf due to the height and depth of the toekick • Toekick height: 9" • Available width: 42" 	B42ADA	21.0	✓	✓	✓	✓	✓	✓	✓

DRAWER BASE CABINET – 32 1/2" HIGH – 24" DEEP

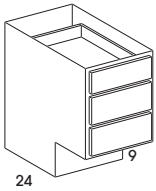
 <ul style="list-style-type: none"> • Three drawers • ADA Bases do not include an interior shelf due to the height and depth of the toekick • Toekick height: 9" • Available widths: 12"-36" 	DB12D3ADA	6.0	✓	✓	✓	✓	✓	✓	✓
	DB15D3ADA	8.0	✓	✓	✓	✓	✓	✓	✓
	DB18D3ADA	9.0	✓	✓	✓	✓	✓	✓	✓
	DB21D3ADA	11.0	✓	✓	✓	✓	✓	✓	✓
	DB24D3ADA	12.0	✓	✓	✓	✓	✓	✓	✓
	DB27D3ADA	14.0	✓	✓	✓	✓	✓	✓	✓
	DB30D3ADA	15.0	✓	✓	✓	✓	✓	✓	✓
	DB36D3ADA	18.0	✓	✓	✓	✓	✓	✓	✓

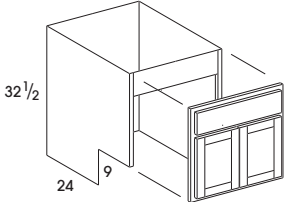
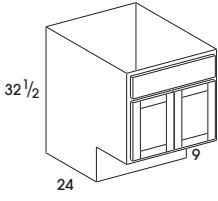
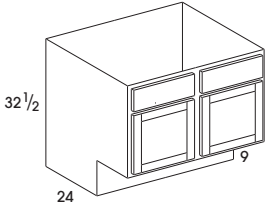
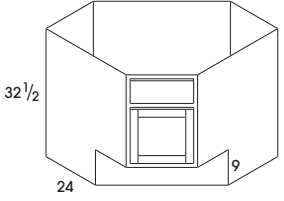
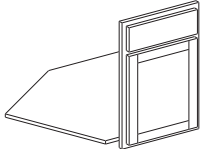

ADA Base Cabinets – 24" Deep

Design Tips: <ul style="list-style-type: none"> Please confirm specifications with local code enforcement agencies prior to ordering; these items are non-returnable All single-door cabinets are hinged left Doors will be reversed during installation for right hinge applications Special Order items are not in stock and require a longer lead time to deliver 		SKU	cubes	STANDARD				COMPLEMENTS PAINT		
				Hanover	Dartmouth	Dartmouth 5-piece York Waverly	Berwyn	Hanover Complements Paint	Dartmouth Complements Paint	Dartmouth 5-piece York Waverly Complements Paint
REMOVABLE FRONT BASE CABINETS – 32 1/2" HIGH – 24" DEEP										
	<ul style="list-style-type: none"> Interior finish: natural on stained products/white on painted products Removable fronts are attached to the face frame using barrel catch hardware Includes removable floor ADA Bases do not include an interior shelf due to the height and depth of the toe kick Toekick height: 9" Available width: 30"-36" 	SB30REMADA	15.0	✓	✓	✓	✓	✓	✓	
		SB33REMADA	16.0	✓	✓	✓	✓	✓	✓	
		SB36REMADA	18.0	✓	✓	✓	✓	✓	✓	
SINK BASE CABINET – 32 1/2" HIGH – 24" DEEP										
	<ul style="list-style-type: none"> Two butt doors One false panel ADA Bases do not include an interior shelf due to the height and depth of the toe kick Toekick height: 9" Available width: 24"-36" 	SB24DDADA	12.0	✓	✓	✓	✓	✓	✓	
		SB27ADA	13.0	✓	✓	✓	✓	✓	✓	
		SB30ADA	15.0	✓	✓	✓	✓	✓	✓	
		SB33ADA	16.0	✓	✓	✓	✓	✓	✓	
		SB36ADA	18.0	✓	✓	✓	✓	✓	✓	
	<ul style="list-style-type: none"> Two doors, cabinet with center stile Two false panels ADA Bases do not include an interior shelf due to the height and depth of the toe kick Toekick height: 9" Available widths: 39" and 42" 	SB39ADA	19.0	✓	✓	✓	✓	✓	✓	
		SB42ADA	21.0	✓	✓	✓	✓	✓	✓	
CORNER SINK BASE CABINET – 32 1/2" HIGH – 24" DEEP										
	<ul style="list-style-type: none"> Single door One false panel Full cabinet ADA Bases do not include an interior shelf due to the height and depth of the toe kick Toekick height: 9" Available widths: 36" and 42" 	SCB36ADA	26.0	✓	✓	✓	✓	✓	✓	
		SCB42ADA	34.0	✓	✓	✓	✓	✓	✓	
CORNER SINK BASE FACE FRAME AND DOOR										
	<ul style="list-style-type: none"> Single door One false panel Face frame and floor only ADA Bases do not include an interior shelf due to the height and depth of the toe kick Toekick height: 9" Available width: 36" 	SCB36FFADA	1.0	✓	✓	✓	✓	✓	✓	



ADA Base Cabinets

Design Tips: • Please confirm specifications with local code enforcement agencies prior to ordering; these items are non-returnable • All single-door cabinets are hinged left • Doors will be reversed during installation for right hinge applications • Special Order items are not in stock and require a longer lead time to deliver	SKU	cubes	STANDARD				COMPLEMENTS PAINT		
			Hanover	Dartmouth	Dartmouth 5-piece York Waverly	Berwyn	Hanover Complements Paint	Dartmouth Complements Paint	Dartmouth 5-piece York Waverly Complements Paint

BASE SUSAN EASY REACH - 32 1/2" HIGH

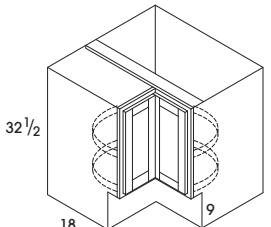
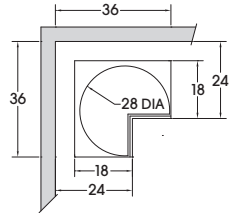
 <p>Use when household doorway opening is less than 34 1/2"</p>	<ul style="list-style-type: none"> Bifold doors Independent rotating plastic shelves 28" diameter lazy susan Soft Close not available Available width: 36" <p>Note: SER36ADA cabinet depth is 18" deep for easy access and must be installed 6" from wall to align with adjacent 24" deep cabinet</p> 	SER36ADA	26.0	✓	✓	✓	✓	✓	✓	✓

BASE EASY REACH - 32 1/2" HIGH - 24" DEEP

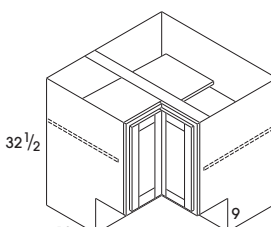
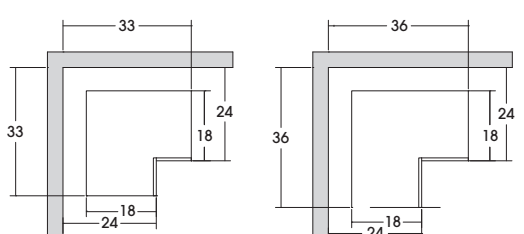
	<ul style="list-style-type: none"> Bifold doors Two adjustable shelves BER33: opening is 10 1/2" BER36: opening is 14 3/4" ADA Bases do not include an interior shelf due to the height and depth of the toe kick Toekick height: 9" Available widths: 33" and 36" 	BER33ADA	18.0	✓	✓	✓	✓	✓	✓	✓	
											✓
		BER36ADA	26.0	✓	✓	✓	✓	✓	✓	✓	✓



ADA Base Cabinets

Design Tips:

- Please confirm specifications with local code enforcement agencies prior to ordering; these items are non-returnable
- All single-door cabinets are hinged left
- Doors will be reversed during installation for right hinge applications
- Special Order items are not in stock and require a longer lead time to deliver

SKU	cubes	STANDARD				COMPLEMENTS PAINT		
		Hanover	Dartmouth	Dartmouth 5-piece York Waverly	Berwyn	Hanover Complements Paint	Dartmouth Complements Paint	Dartmouth 5-piece York Waverly Complements Paint

BASE END CABINET - 32 1/2" HIGH - 12" DEEP

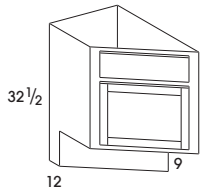

- Single door
- One false panel
- Choose right or left hand
- ADA Bases do not include an interior shelf due to the height and depth of the toe kick
- Toekick height: 9"
- Available width: 12"

BEC12LADA	6.0	✓	✓	✓	✓	✓	✓	✓
BEC12RADA	6.0	✓	✓	✓	✓	✓	✓	✓

BASE CORNER - 32 1/2" HIGH - 24" DEEP

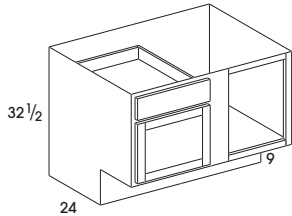

- Single door
- One drawer
- ADA Bases do not include an interior shelf due to the height and depth of the toe kick
- Toekick height: 9"
- Does not include filler

BC36ADA	18.0	✓	✓	✓	✓	✓	✓	✓
BC42ADA	21.0	✓	✓	✓	✓	✓	✓	✓
BC48ADA	23.0	✓	✓	✓	✓	✓	✓	✓

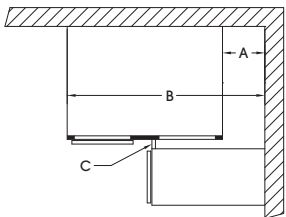

SKU	Cabinet Width	Blind Opening	Center Stile	A			B			C
				Minimum		Maximum	Minimum		Maximum	
				SO	FO		SO	FO		
BC36ADA	27"	9"	6"	9 ³ / ₄ "	10 ¹ / ₂ "	13 ¹ / ₂ "	36 ³ / ₄ "	37 ¹ / ₂ "	40 ¹ / ₂ "	7/8"
BC42ADA	36"	13 ¹ / ₂ "		5 ¹ / ₄ "	6"	9"	41 ¹ / ₄ "	42"	45"	
BC48ADA	48"	19 ¹ / ₂ "		0"	0"	3"	48"	48"	51"	

A = Pull distance from wall
 B = Cabinet distance from wall
 C = Minimum filler width

SO = Standard Overlay (Hanover)
 FO = Full Overlay (Berwyn, Dartmouth, York, Waverly)

Minimum filler width requirement (C) based on 7/8" high hardware

Note: Blind openings are right side; door and drawer can be reversed during installation for left blind application.



ADA Tall Cabinets – 24" Deep

Design Tips: • Please confirm specifications with local code enforcement agencies prior to ordering; these items are non-returnable • All single-door cabinets are hinged left • Doors will be reversed during installation for right hinge applications • Special Order items are not in stock and require a longer lead time to deliver	SKU	cubes	STANDARD				COMPLEMENTS PAINT			
			Hanover	Dartmouth	Dartmouth 5-piece York Waverly	Berwyn	Hanover Complements Paint	Dartmouth Complements Paint	Dartmouth 5-piece York Waverly Complements Paint	

UTILITY CABINET – 24" DEEP

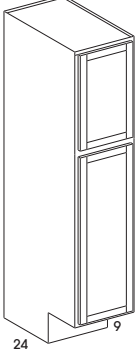
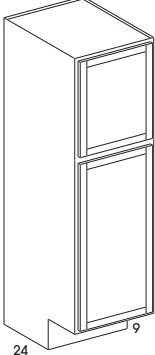
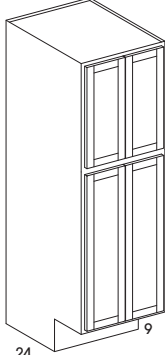
	<ul style="list-style-type: none"> • Two doors • Shelves not included • Unfinished toeckick is attached to all utility cabinets • Toeckick height: 9" • Available width: 18" 	U188424ADA	21.0	✓	✓	✓	✓	✓	✓	✓
		U189024ADA	23.0	✓	✓	✓	✓	✓	✓	✓
		U189624ADA	24.0	✓	✓	✓	✓	✓	✓	✓
	<ul style="list-style-type: none"> • Two doors • Shelves not included • Unfinished toeckick is attached to all utility cabinets • Toeckick height: 9" • Available width: 24" 	U248424ADA	28.0	✓	✓	✓	✓	✓	✓	✓
		U249024ADA	30.0	✓	✓	✓	✓	✓	✓	✓
		U249624ADA	32.0	✓	✓	✓	✓	✓	✓	✓
	<ul style="list-style-type: none"> • Two sets of butt doors • Shelves not included • Unfinished toeckick is attached to all utility cabinets • Toeckick height: 9" • Available width: 24" 	U248424DDADA	28.0	✓	✓	✓	✓	✓	✓	✓
		U249024DDADA	30.0	✓	✓	✓	✓	✓	✓	✓
		U249624DDADA	32.0	✓	✓	✓	✓	✓	✓	✓

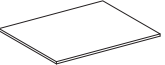
	SKU	cubes	White	Natural
UTILITY CABINET SHELF				
 <ul style="list-style-type: none"> • SHELFKIT includes four shelves and clips • SHELF includes single shelf only, no clips • 1824 shelf: 22³/₁₆" x 16³/₁₆" • 2424 shelf: 22³/₁₆" x 22³/₁₆" 	U1824SHELFK	1.0	✓	✓
	U2424SHELFK	1.0	✓	✓
	U1824SHELF	1.0	✓	✓
	U2424SHELF	1.0	✓	✓



ADA Tall Cabinets – 24" Deep

Design Tips: • Please confirm specifications with local code enforcement agencies prior to ordering; these items are non-returnable • Special Order items are not in stock and require a longer lead time to deliver	SKU	cubes	STANDARD				COMPLEMENTS PAINT		
			Hanover	Dartmouth	Dartmouth 5-piece York Waverly	Berwyn	Hanover Complements Paint	Dartmouth Complements Paint	Dartmouth 5-piece York Waverly Complements Paint

OVEN CABINET – 24" DEEP

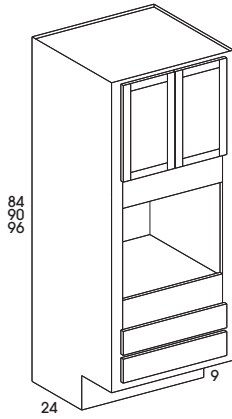

- Two butt doors
- No shelves included in upper cabinet
- If desired order OCSHELF below for 90" and 96" tall oven cabinets
- Two bottom drawers
- Inside opening is natural/white
- Toekick height: 9"
- Available width: 33"

OC338424ADA	39.0	✓	✓	✓	✓	✓	✓	✓
OC339024ADA	42.0	✓	✓	✓	✓	✓	✓	✓
OC339624ADA	44.0	✓	✓	✓	✓	✓	✓	✓

SKU	cubes	White	Natural
-----	-------	-------	---------

UTILITY CABINET SHELF

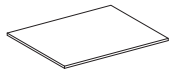

- Full depth 3/4" shelf to add to the upper cabinet of 90" and 96" tall cabinet
- 22 3/16" x 31 3/16"
- Shelf clips must be ordered separately

OC3324SHELF	1.0	✓	✓
-------------	-----	---	---

ADA Vanity Cabinets – 21" Deep

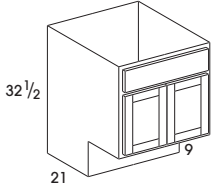
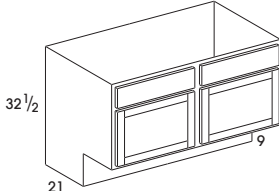
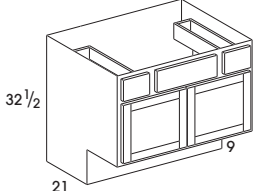
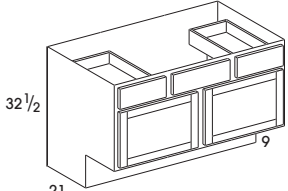
Design Tips: • Please confirm specifications with local code enforcement agencies prior to ordering; these items are non-returnable • Special Order items are not in stock and require a longer lead time to deliver		SKU	cubes	STANDARD				COMPLEMENTS PAINT		
				Hanover	Dartmouth	Dartmouth 5-piece York Waverly	Berwyn	Hanover Complements Paint	Dartmouth Complements Paint	Dartmouth 5-piece York Waverly Complements Paint
VANITY SINK BASE – 32 1/2" HIGH – 21" DEEP										
	<ul style="list-style-type: none"> • Two butt doors • One false panel • ADA Bases do not include an interior shelf due to the height and depth of the toe kick • Toe kick height: 9" • Available widths: 24"-36" 	VSB24DDADA	11.0	✓	✓	✓	✓	✓	✓	✓
		VSB27ADA	12.0	✓	✓	✓	✓	✓	✓	✓
		VSB30ADA	13.0	✓	✓	✓	✓	✓	✓	✓
		VSB33ADA	14.0	✓	✓	✓	✓	✓	✓	✓
		VSB36ADA	16.0	✓	✓	✓	✓	✓	✓	✓
	<ul style="list-style-type: none"> • Two doors, cabinet with center stile • Two false panels • ADA Bases do not include an interior shelf due to the height and depth of the toe kick • Toe kick height: 9" • Available width: 48" 	VSB48ADA	21.0	✓	✓	✓	✓	✓	✓	✓
VANITY SINK DRAWER BASE – 32 1/2" HIGH – 21" DEEP										
	<ul style="list-style-type: none"> • Two butt doors • Two drawers • One false panel • ADA Bases do not include an interior shelf due to the height and depth of the toe kick • Toe kick height: 9" • Available width: 36" 	VSDB36ADA	16.0	✓	✓	✓	✓	✓	✓	✓
	<ul style="list-style-type: none"> • Two doors, cabinet with center stile • Two drawers • One false panel • ADA Bases do not include an interior shelf due to the height and depth of the toe kick • Toe kick height: 9" • Available widths: 42" and 48" 	VSDB42ADA	18.0	✓	✓	✓	✓	✓	✓	✓
		VSDB48ADA	21.0	✓	✓	✓	✓	✓	✓	✓

ADA Vanity Cabinets – 21" Deep

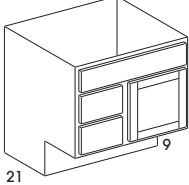
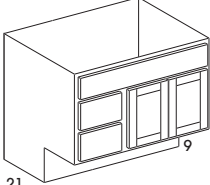
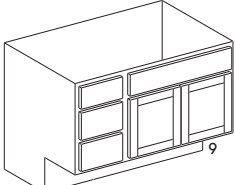
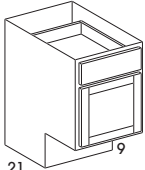
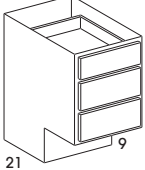
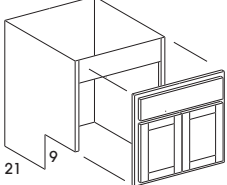
Design Tips: <ul style="list-style-type: none"> • Please confirm specifications with local code enforcement agencies prior to ordering; these items are non-returnable • All single-door cabinets are hinged left • Doors will be reversed during installation for right hinge applications • Special Order items are not in stock and require a longer lead time to deliver 		SKU	cubes	STANDARD				COMPLEMENTS PAINT		
				Hanover	Dartmouth	Dartmouth 5-piece York Waverly	Berwyn	Hanover Complements Paint	Dartmouth Complements Paint	Dartmouth 5-piece York Waverly Complements Paint
VANITY COMBO CABINET – 32 1/2" HIGH – 21" DEEP										
 <p>32 1/2 21 9</p>	<ul style="list-style-type: none"> • Single door • One false panel • VBL: drawers on left • VBR: drawers on right • ADA Bases do not include an interior shelf due to the height and depth of the toekick • Toekick height: 9" • Available width: 30" 	VBL30ADA	13.0	✓	✓	✓	✓	✓	✓	✓
		VBR30ADA	13.0	✓	✓	✓	✓	✓	✓	✓
 <p>32 1/2 21 9</p>	<ul style="list-style-type: none"> • Two butt doors • One false panel • VBL: drawers on left • VBR: drawers on right • ADA Bases do not include an interior shelf due to the height and depth of the toekick • Toekick height: 9" • Available width: 36" 	VBL36ADA	15.0	✓	✓	✓	✓	✓	✓	
		VBR36ADA	15.0	✓	✓	✓	✓	✓	✓	✓
 <p>32 1/2 21 9</p>	<ul style="list-style-type: none"> • Two butt doors • Two false panels • VBL: drawers on left • VBR: drawers on right • ADA Bases do not include an interior shelf due to the height and depth of the toekick • Toekick height: 9" • Available width: 42" 	VBL42ADA	18.0	✓	✓	✓	✓	✓	✓	
		VBR42ADA	18.0	✓	✓	✓	✓	✓	✓	✓
VANITY BASE CABINET – 32 1/2" HIGH – 21" DEEP										
 <p>32 1/2 21 9</p>	<ul style="list-style-type: none"> • Single door • One drawer • ADA Bases do not include an interior shelf due to the height and depth of the toekick • Toekick height: 9" • Available widths: 12"-18" 	VB12ADA	6.0	✓	✓	✓	✓	✓	✓	
		VB15ADA	7.0	✓	✓	✓	✓	✓	✓	
		VB18ADA	8.0	✓	✓	✓	✓	✓	✓	
VANITY DRAWER BASE CABINET – 32 1/2" HIGH – 21" DEEP										
 <p>32 1/2 21 9</p>	<ul style="list-style-type: none"> • Three drawers • ADA Bases do not include an interior shelf due to the height and depth of the toekick • Toekick height: 9" • Available widths: 12"-18" 	VDB12ADA	6.0	✓	✓	✓	✓	✓	✓	
		VDB15ADA	7.0	✓	✓	✓	✓	✓	✓	
		VDB18ADA	8.0	✓	✓	✓	✓	✓	✓	
REMOVABLE FRONT VANITY CABINETS – 32 1/2" HIGH – 21" DEEP										
 <p>32 1/2 21 9</p>	<ul style="list-style-type: none"> • Interior finish: natural on stained products/white on painted products • Removable fronts are attached to the face frame using barrel catch hardware • Includes removable floor • ADA Bases do not include an interior shelf due to the height and depth of the toekick • Toekick height: 9" • Available widths: 30"-36" 	VSB30REMADA	13.0	✓	✓	✓	✓	✓	✓	
		VSB33REMADA	14.0	✓	✓	✓	✓	✓	✓	
		VSB36REMADA	16.0	✓	✓	✓	✓	✓	✓	



Universal Design Base Cabinets – 24" Deep

Design Tips: • Please confirm specifications with local code enforcement agencies prior to ordering; these items are non-returnable • All single-door cabinets are hinged left • Doors will be reversed during installation for right hinge applications • Special Order items are not in stock and require a longer lead time to deliver	SKU	cubes	STANDARD				COMPLEMENTS PAINT			
			Hanover	Dartmouth	Dartmouth 5-piece York Waverly	Berwyn	Hanover Complements Paint	Dartmouth Complements Paint	Dartmouth 5-piece York Waverly Complements Paint	

BASE CABINET – 32 1/2" HIGH – 24" DEEP

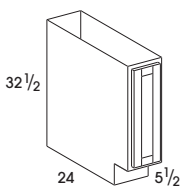
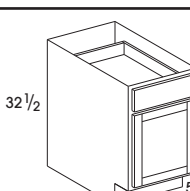
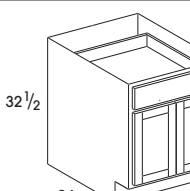
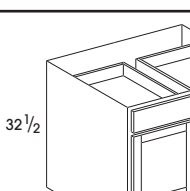
 <ul style="list-style-type: none"> • One full height door • Shelves not available • UD Bases do not include an interior shelf due to the height and depth of the toe kick • Toekick height: 5 1/2" • Available width: 9" 	B09FHUD	5.0	✓	✓	✓	✓	✓	✓	✓
 <ul style="list-style-type: none"> • Single door • One drawer • Shelves not available • UD Bases do not include an interior shelf due to the height and depth of the toe kick • Toekick height: 5 1/2" • Available widths: 12"-21" 	B12UD	6.0	✓	✓	✓	✓	✓	✓	✓
	B15UD	8.0	✓	✓	✓	✓	✓	✓	✓
	B18UD	9.0	✓	✓	✓	✓	✓	✓	✓
	B21UD	11.0	✓	✓	✓	✓	✓	✓	✓
 <ul style="list-style-type: none"> • Two butt doors • One drawer • Shelves not available • UD Bases do not include an interior shelf due to the height and depth of the toe kick • Toekick height: 5 1/2" • Available widths: 24"-36" 	B24DDUD	12.0	✓	✓	✓	✓	✓	✓	✓
	B27UD	13.0	✓	✓	✓	✓	✓	✓	✓
	B30UD	15.0	✓	✓	✓	✓	✓	✓	✓
	B33UD	16.0	✓	✓	✓	✓	✓	✓	✓
	B36UD	18.0	✓	✓	✓	✓	✓	✓	✓
 <ul style="list-style-type: none"> • Two doors, cabinet with center stile • Two drawers • Shelves not available • UD Bases do not include an interior shelf due to the height and depth of the toe kick • Toekick height: 5 1/2" • Available width: 42" 	B42UD	21.0	✓	✓	✓	✓	✓	✓	✓

DRAWER BASE CABINET – 32 1/2" HIGH – 24" DEEP

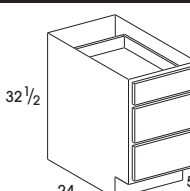
 <ul style="list-style-type: none"> • Three drawers • UD Bases do not include an interior shelf due to the height and depth of the toe kick • Toekick height: 5 1/2" • Available widths: 12"-36" 	DB12D3UD	6.0	✓	✓	✓	✓	✓	✓	✓
	DB15D3UD	8.0	✓	✓	✓	✓	✓	✓	✓
	DB18D3UD	9.0	✓	✓	✓	✓	✓	✓	✓
	DB21D3UD	11.0	✓	✓	✓	✓	✓	✓	✓
	DB24D3UD	12.0	✓	✓	✓	✓	✓	✓	✓
	DB27D3UD	14.0	✓	✓	✓	✓	✓	✓	✓
	DB30D3UD	15.0	✓	✓	✓	✓	✓	✓	✓
	DB36D3UD	18.0	✓	✓	✓	✓	✓	✓	✓

Universal Design Base Cabinets – 24" Deep

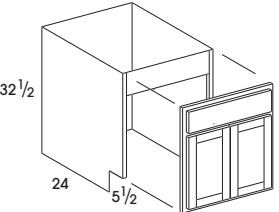
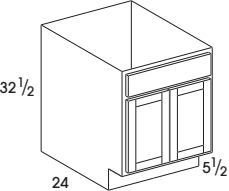
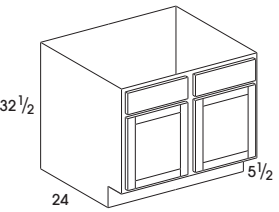
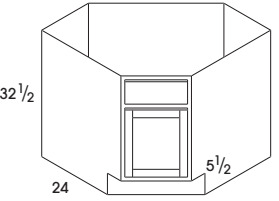
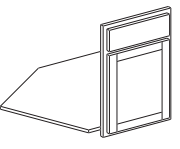
Design Tips: <ul style="list-style-type: none"> Please confirm specifications with local code enforcement agencies prior to ordering; these items are non-returnable All single-door cabinets are hinged left Doors will be reversed during installation for right hinge applications Special Order items are not in stock and require a longer lead time to deliver 	SKU	cubes	STANDARD				COMPLEMENTS PAINT		
			Hanover	Dartmouth	Dartmouth 5-piece York Waverly	Berwyn	Hanover Complements Paint	Dartmouth Complements Paint	Dartmouth 5-piece York Waverly Complements Paint
REMOVABLE FRONT BASE CABINETS – 32 1/2" HIGH – 24" DEEP									
 <ul style="list-style-type: none"> Interior finish: natural on stained products/white on painted products Removable fronts are attached to the face frame using barrel catch hardware Includes removable floor UD Bases do not include an interior shelf due to the height and depth of the toekick Toekick height: 5 1/2" Available widths: 30"-36" 	SB30REMUD	15.0	✓	✓	✓	✓	✓	✓	✓
	SB33REMUD	16.0	✓	✓	✓	✓	✓	✓	✓
	SB36REMUD	18.0	✓	✓	✓	✓	✓	✓	✓
SINK BASE CABINET – 32 1/2" HIGH – 24" DEEP									
 <ul style="list-style-type: none"> Two butt doors One false panel UD Bases do not include an interior shelf due to the height and depth of the toekick Toekick height: 5 1/2" Available widths: 24"-36" 	SB24DDUD	12.0	✓	✓	✓	✓	✓	✓	✓
	SB27UD	13.0	✓	✓	✓	✓	✓	✓	✓
	SB30UD	15.0	✓	✓	✓	✓	✓	✓	✓
	SB33UD	16.0	✓	✓	✓	✓	✓	✓	✓
	SB36UD	18.0	✓	✓	✓	✓	✓	✓	✓
 <ul style="list-style-type: none"> Two doors, cabinet with center stile Two false panels UD Bases do not include an interior shelf due to the height and depth of the toekick Toekick height: 5 1/2" Available widths: 39" and 42" 	SB39UD	19.0	✓	✓	✓	✓	✓	✓	✓
	SB42UD	21.0	✓	✓	✓	✓	✓	✓	✓
CORNER SINK BASE CABINET – 32 1/2" HIGH – 24" DEEP									
 <ul style="list-style-type: none"> Single door One false panel Full cabinet UD Bases do not include an interior shelf due to the height and depth of the toekick Toekick height: 5 1/2" Available widths: 36" and 42" 	SCB36UD	26.0	✓	✓	✓	✓	✓	✓	✓
	SCB42UD	34.0	✓	✓	✓	✓	✓	✓	✓
CORNER SINK FACE FRAME AND DOOR									
 <ul style="list-style-type: none"> Single door One false panel Face frame and floor only UD Bases do not include an interior shelf due to the height and depth of the toekick Toekick height: 5 1/2" Available width: 36" 	SCB36FFUD	1.0	✓	✓	✓	✓	✓	✓	✓

Universal Design Base Cabinets

Design Tips:

- Please confirm specifications with local code enforcement agencies prior to ordering; these items are non-returnable
- All single-door cabinets are hinged left
- Doors will be reversed during installation for right hinge applications
- **Special Order items are not in stock and require a longer lead time to deliver**

SKU

cupes

STANDARD

COMPLEMENTS PAINT

Hanover

Dartmouth

Dartmouth 5-piece York Waverly

Berwyn

Hanover Complements Paint

Dartmouth Complements Paint

Dartmouth 5-piece York Waverly Complements Paint

BASE SUSAN EASY REACH - 32 1/2" HIGH

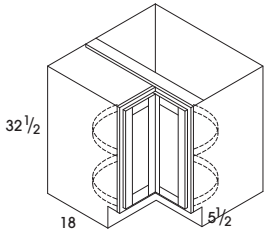

Use when household doorway opening is less than 34 1/2"

- Bifold doors
- Independent rotating plastic shelves
- 28" diameter lazy susan
- Soft Close not available
- Available width: 36"

Note: SER36UD cabinet depth is 18" deep for easy access and must be installed 6" from wall to align with adjacent 24" deep cabinet

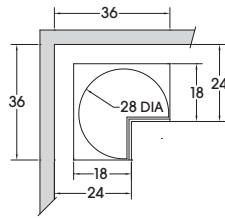

SER36UD

26.0

✓

✓

✓

✓

✓

✓

✓

BASE EASY REACH - 32 1/2" HIGH - 24" DEEP

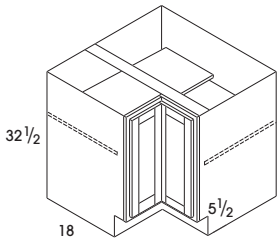

- Bifold doors
- Two adjustable shelves
- BER33: opening is 10 1/2"
- BER36: opening is 14 3/4"
- UD Bases do not include an interior shelf due to the height and depth of the toekick
- Toekick height: 5 1/2"
- Available widths: 33" and 36"

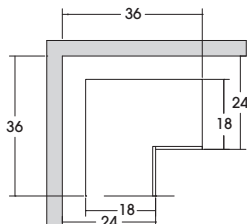
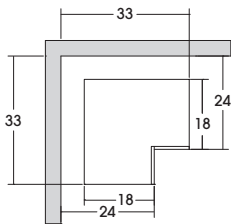

BER33UD

18.0

✓

✓

✓

✓

✓

✓

✓

BER36UD

26.0

✓

✓

✓

✓

✓

✓

✓

Universal Design Base Cabinets

Design Tips:

- Please confirm specifications with local code enforcement agencies prior to ordering; these items are non-returnable
- All single-door cabinets are hinged left
- Doors will be reversed during installation for right hinge applications
- Special Order items are not in stock and require a longer lead time to deliver

SKU	cubes	STANDARD				COMPLEMENTS PAINT		
		Hanover	Dartmouth	Dartmouth 5-piece York Waverly	Berwyn	Hanover Complements Paint	Dartmouth Complements Paint	Dartmouth 5-piece York Waverly Complements Paint

BASE END CABINET - 32 1/2" HIGH - 12" DEEP

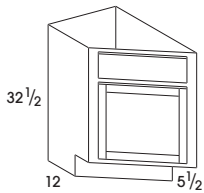

- Single door
- One false panel
- Choose right or left hand
- UD Bases do not include an interior shelf due to the height and depth of the toe-kick
- Toe-kick height: 5 1/2"
- Available width: 12"

BEC12LUD	6.0	✓	✓	✓	✓	✓	✓	✓
BEC12RUD	6.0	✓	✓	✓	✓	✓	✓	✓

BASE CORNER - 32 1/2" HIGH - 24" DEEP

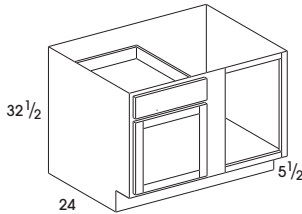

- Single door
- One drawer
- Does not include filler
- UD Bases do not include an interior shelf due to the height and depth of the toe-kick
- Toe-kick height: 5 1/2"

BC36UD	18.0	✓	✓	✓	✓	✓	✓	✓
BC42UD	21.0	✓	✓	✓	✓	✓	✓	✓
BC48UD	23.0	✓	✓	✓	✓	✓	✓	✓

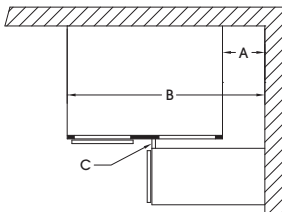

SKU	Cabinet Width	Blind Opening	Center Style	A			B			C
				Minimum		Maximum	Minimum		Maximum	
				SO	FO		SO	FO		
BC36UD	27"	9"	6"	9 3/4"	10 1/2"	13 1/2"	36 3/4"	37 1/2"	40 1/2"	7/8"
BC42UD	36"	13 1/2"		5 1/4"	6"	9"	41 1/4"	42"	45"	
BC48UD	48"	19 1/2"		0"	0"	3"	48"	48"	51"	

A = Pull distance from wall
 B = Cabinet distance from wall
 C = Minimum filler width

SO = Standard Overlay (Hanover)
 FO = Full Overlay (Berwyn, Dartmouth, York, Waverly)

Minimum filler width requirement (C) based on 7/8" high hardware

Note: Blind openings are right side: door and drawer can be reversed during installation for left blind application.

Universal Design Tall Cabinets – 24" Deep

Design Tips: • Please confirm specifications with local code enforcement agencies prior to ordering; these items are non-returnable • All single-door cabinets are hinged left • Doors will be reversed during installation for right hinge applications • Special Order items are not in stock and require a longer lead time to deliver	SKU	cubes	STANDARD				COMPLEMENTS PAINT			
			Hanover	Dartmouth	Dartmouth 5-piece York Waverly	Berwyn	Hanover Complements Paint	Dartmouth Complements Paint	Dartmouth 5-piece York Waverly Complements Paint	

UTILITY CABINET – 24" DEEP

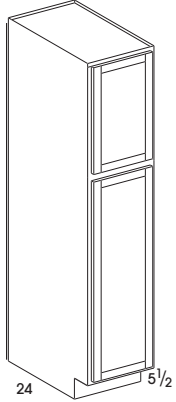
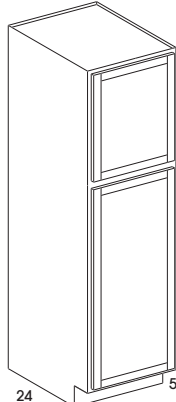
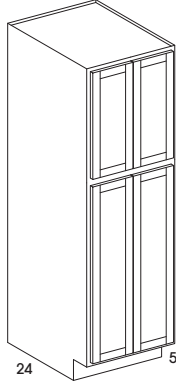
 <ul style="list-style-type: none"> • Two doors • Shelves not included • Unfinished toekick is attached to all utility cabinets • Toekick height: 5 1/2" • Available width: 18" 	U188424UD	21.0	✓	✓	✓	✓	✓	✓	✓
	U189024UD	23.0	✓	✓	✓	✓	✓	✓	✓
	U189624UD	24.0	✓	✓	✓	✓	✓	✓	✓
 <ul style="list-style-type: none"> • Two doors • Shelves not included • Unfinished toekick is attached to all utility cabinets • Toekick height: 5 1/2" • Available width: 24" 	U248424UD	28.0	✓	✓	✓	✓	✓	✓	✓
	U249024UD	30.0	✓	✓	✓	✓	✓	✓	✓
	U249624UD	32.0	✓	✓	✓	✓	✓	✓	✓
 <ul style="list-style-type: none"> • Two sets of butt doors • Shelves not included • Unfinished toekick is attached to all utility cabinets • Toekick height: 5 1/2" • Available width: 24" 	U248424DDUD	28.0	✓	✓	✓	✓	✓	✓	✓
	U249024DDUD	30.0	✓	✓	✓	✓	✓	✓	✓
	U249624DDUD	32.0	✓	✓	✓	✓	✓	✓	✓

SKU	cubes	White	Natural
-----	-------	-------	---------

UTILITY CABINET SHELF

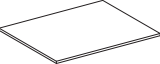
 <ul style="list-style-type: none"> • SHELFKIT includes four shelves and clips • SHELF includes single shelf only, no clips • 1824 shelf: 22 3/16" x 16 3/16" • 2424 shelf: 22 3/16" x 22 3/16" 	U1824SHELFK	1.0	✓	✓
	U2424SHELFK	1.0	✓	✓
	U1824SHELF	1.0	✓	✓
	U2424SHELF	1.0	✓	✓

Universal Design Tall Cabinets – 24" Deep

Design Tips: • Please confirm specifications with local code enforcement agencies prior to ordering; these items are non-returnable • All single-door cabinets are hinged left • Doors will be reversed during installation for right hinge applications • Special Order items are not in stock and require a longer lead time to deliver	SKU	cubes	STANDARD				COMPLEMENTS PAINT		
			Hanover	Dartmouth	Dartmouth 5-piece York Waverly	Berwyn	Hanover Complements Paint	Dartmouth Complements Paint	Dartmouth 5-piece York Waverly Complements Paint

OVEN CABINET – 24" DEEP

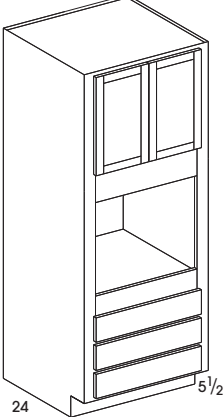
 <ul style="list-style-type: none"> • Two butt doors • No shelves included in upper cabinet • If desired order OCSHELF below for 90" and 96" tall oven cabinets • Three bottom drawers • Two top drawers may be removed cut to create a double Oven opening • Inside opening is natural/white • Toekick height: 5 1/2" • Available width: 33" 	OC338424UD	39.0	✓	✓	✓	✓	✓	✓	✓
	OC339024UD	42.0	✓	✓	✓	✓	✓	✓	✓
	OC339624UD	44.0	✓	✓	✓	✓	✓	✓	✓

SKU	cubes	White	Natural
-----	-------	-------	---------

OVEN CABINET SHELF

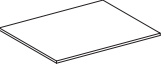
 <ul style="list-style-type: none"> • Full depth 3/4" shelf to add to the upper cabinet of 90" and 96" tall cabinet • 22 3/16" x 31 3/16" • Shelf clips must be ordered separately 	OC3324SHELF	1.0	✓	✓
--------------------------------------------------------------------------------------------------------------------------------------------------------------------------------------------------------------------------------------------------------------------------------------------------------	-------------	-----	---	---

Universal Design Vanity Cabinets – 21" Deep

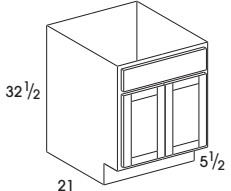
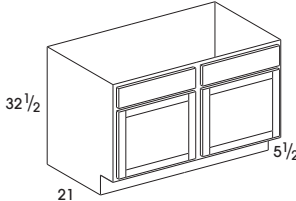
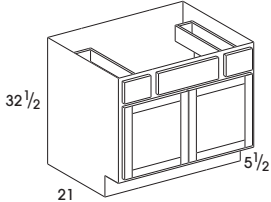
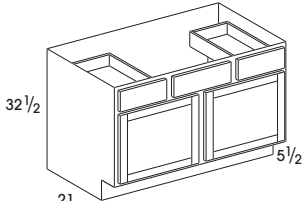
Design Tips: • Please confirm specifications with local code enforcement agencies prior to ordering; these items are non-returnable • Special Order items are not in stock and require a longer lead time to deliver		SKU	cubes	STANDARD				COMPLEMENTS PAINT			
				Hanover	Dartmouth	Dartmouth 5-piece York Waverly	Berwyn	Hanover Complements Paint	Dartmouth Complements Paint	Dartmouth 5-piece York Waverly Complements Paint	
VANITY SINK BASE – 32 1/2" HIGH – 21" DEEP											
 <ul style="list-style-type: none"> • Two butt doors • One false panel • UD Bases do not include an interior shelf due to the height and depth of the toe kick • Toe kick height: 5 1/2" • Available widths: 24"-36" 	VSB24DDUD	11.0	✓	✓	✓	✓	✓	✓	✓		
	VSB27UD	12.0	✓	✓	✓	✓	✓	✓	✓		
	VSB30UD	13.0	✓	✓	✓	✓	✓	✓	✓		
	VSB33UD	14.0	✓	✓	✓	✓	✓	✓	✓		
	VSB36UD	16.0	✓	✓	✓	✓	✓	✓	✓		
 <ul style="list-style-type: none"> • Two doors, cabinet with center stile • Two false panels • UD Bases do not include an interior shelf due to the height and depth of the toe kick • Toe kick height: 5 1/2" • Available width: 48" 	VSB48UD	21.0	✓	✓	✓	✓	✓	✓	✓		
VANITY SINK DRAWER BASE – 32 1/2" HIGH – 21" DEEP											
 <ul style="list-style-type: none"> • Two butt doors • Two drawers • One false panel • UD Bases do not include an interior shelf due to the height and depth of the toe kick • Toe kick height: 5 1/2" • Available width: 36" 	VSDB36UD	16.0	✓	✓	✓	✓	✓	✓	✓		
 <ul style="list-style-type: none"> • Two doors, cabinet with center stile • Two drawers • One false panel • UD Bases do not include an interior shelf due to the height and depth of the toe kick • Toe kick height: 5 1/2" • Available widths: 42" and 48" 	VSDB42UD	18.0	✓	✓	✓	✓	✓	✓	✓		
	VSDB48UD	21.0	✓	✓	✓	✓	✓	✓	✓		

Universal Design Vanity Cabinets – 21" Deep

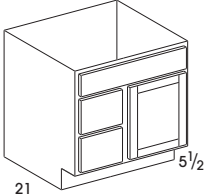
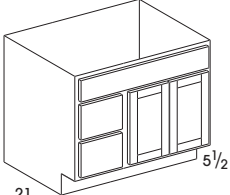
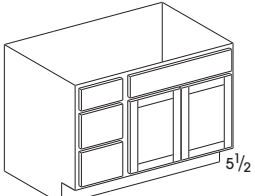
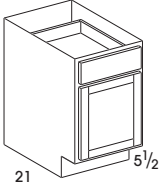
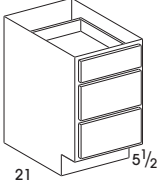
Design Tips: <ul style="list-style-type: none"> • Please confirm specifications with local code enforcement agencies prior to ordering; these items are non-returnable • All single-door cabinets are hinged left • Doors will be reversed during installation for right hinge applications • Special Order items are not in stock and require a longer lead time to deliver 		SKU	cubes	STANDARD				COMPLEMENTS PAINT		
				Hanover	Dartmouth	Dartmouth 5-piece York Waverly	Berwyn	Hanover Complements Paint	Dartmouth Complements Paint	Dartmouth 5-piece York Waverly Complements Paint
VANITY COMBO CABINET – 32 1/2" HIGH – 21" DEEP										
	<ul style="list-style-type: none"> • Single door • One false panel • VBL: drawers on left • VBR: drawers on right • UD Bases do not include an interior shelf due to the height and depth of the toe kick • Toekick height: 5 1/2" • Available width: 30" 	VBL30UD	13.0	✓	✓	✓	✓	✓	✓	✓
		VBR30UD	13.0	✓	✓	✓	✓	✓	✓	✓
	<ul style="list-style-type: none"> • Two butt doors • One false panel • VBL: drawers on left • VBR: drawers on right • UD Bases do not include an interior shelf due to the height and depth of the toe kick • Toekick height: 5 1/2" • Available width: 36" 	VBL36UD	15.0	✓	✓	✓	✓	✓	✓	
		VBR36UD	15.0	✓	✓	✓	✓	✓	✓	✓
	<ul style="list-style-type: none"> • Two butt doors • Two false panels • VBL: drawers on left • VBR: drawers on right • UD Bases do not include an interior shelf due to the height and depth of the toe kick • Toekick height: 5 1/2" • Available width: 42" 	VBL42UD	18.0	✓	✓	✓	✓	✓	✓	
		VBR42UD	18.0	✓	✓	✓	✓	✓	✓	✓
VANITY BASE CABINET – 32 1/2" HIGH – 21" DEEP										
	<ul style="list-style-type: none"> • Single door • One drawer • UD Bases do not include an interior shelf due to the height and depth of the toe kick • Toekick height: 5 1/2" • Available widths: 12"-18" 	VB12UD	6.0	✓	✓	✓	✓	✓	✓	
		VB15UD	7.0	✓	✓	✓	✓	✓	✓	
		VB18UD	8.0	✓	✓	✓	✓	✓	✓	
VANITY DRAWER BASE CABINET – 32 1/2" HIGH – 21" DEEP										
	<ul style="list-style-type: none"> • Three drawers • UD Bases do not include an interior shelf due to the height and depth of the toe kick • Toekick height: 5 1/2" • Available widths: 12"-18" 	VDB12UD	6.0	✓	✓	✓	✓	✓	✓	
		VDB15UD	7.0	✓	✓	✓	✓	✓	✓	
		VDB18UD	8.0	✓	✓	✓	✓	✓	✓	

Universal Design Vanity Cabinets – 21" Deep

Design Tips: • Please confirm specifications with local code enforcement agencies prior to ordering; these items are non-returnable • Special Order items are not in stock and require a longer lead time to deliver	SKU	cubes	STANDARD				COMPLEMENTS PAINT			
			Hanover	Dartmouth	Dartmouth 5-piece York Waverly	Berwyn	Hanover Complements Paint	Dartmouth Complements Paint	Dartmouth 5-piece York Waverly Complements Paint	

REMOVABLE FRONT VANITY CABINETS – 32 1/2" HIGH – 21" DEEP

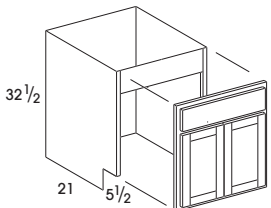
 <ul style="list-style-type: none"> Interior finish: natural on stained products/white on painted products Removable fronts are attached to the face frame using barrel catch hardware Includes removable floor UD Bases do not include an interior shelf due to the height and depth of the toe kick Toekick height: 5 1/2" Available widths: 30"-36" 	VSB30REMUD	13.0	✓	✓	✓	✓	✓	✓	✓
	VSB33REMUD	14.0	✓	✓	✓	✓	✓	✓	✓
	VSB36REMUD	16.0	✓	✓	✓	✓	✓	✓	✓

WALL HUNG VANITY SINK WITH REMOVABLE FRONT – 32 1/2" HIGH

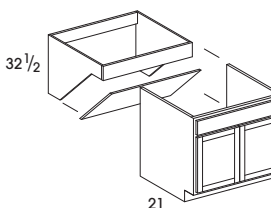
 <ul style="list-style-type: none"> One door on 24" cabinet width Two butt doors on 30", 33" and 36" cabinet widths One false front Includes Wall hung vanity, removable front and plumbing panel Toekick height: 5 1/2" Available widths: 24"-36" 	VSB24WHREMUD	12.0	✓	✓	✓	✓	✓	✓	✓
	VSB30WHREMUD	15.0	✓	✓	✓	✓	✓	✓	✓
	VSB33WHREMUD	16.0	✓	✓	✓	✓	✓	✓	✓
	VSB36WHREMUD	18.0	✓	✓	✓	✓	✓	✓	✓

WALL HUNG VANITY SINK – 32 1/2" HIGH

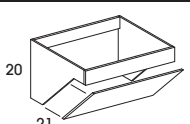
 <ul style="list-style-type: none"> Includes Wall hung vanity and plumbing panel Plumbing panel attaches with spring clips and roller balls Available widths: 24"-36" 	VS24WHUD	10.0	✓	✓	✓	✓	✓	✓	✓
	VS30WHUD	13.0	✓	✓	✓	✓	✓	✓	✓
	VS33WHUD	14.0	✓	✓	✓	✓	✓	✓	✓
	VS36WHUD	16.0	✓	✓	✓	✓	✓	✓	✓

WOLF CLASSIC | 5-YEAR LIMITED WARRANTY

Wolf Classic cabinets have been manufactured under the highest standards of quality and workmanship.

FIVE-YEAR LIMITED WARRANTY ON CABINETS, DRAWER GUIDE AND HINGES

Wolf Home Products warrants to original consumer purchasers for five years from date of original purchase that cabinets, drawers, drawer guides and hinges used in the manufacture of Wolf Classic cabinets shall be free from defects in material and workmanship under normal use.

GENERAL WARRANTY GUIDELINES

Should Wolf Classic cabinets fail during the applicable warranty period due to defects in the material or workmanship under normal use, Wolf Home Products, at its discretion, will repair or provide the parts necessary to replace the defective products.

This warranty is applicable only to products used in residential applications in the United States and is not transferable. This warranty does not cover products that are misused, abused, mishandled, improperly installed, improperly stored, changed, modified or subject to extreme temperatures or extreme moisture levels, or normal wear and tear. This warranty is not valid for products used for any purpose other than the purpose for which they were originally intended. This warranty does not cover the cost of installation, removal, subsequent damage or transportation of the defective product, regardless of whether the work was performed by a contractor, service company or the consumer.

Variations in color and grain pattern are a natural characteristic of wood. Color changes also may result from exposure to light, heat, smoke, household cleaners, and other elements and environmental conditions that are part of the aging process. These material variations and changes are not covered by this warranty. Wolf Home Products reserves the right to substitute for discontinued product the most similar product in styling, wood species and color available at the time a claim is submitted.

Paint finishes are uniquely different from standard wood finishes. On all wood products, expansion and contraction are typical due to changes in climate conditions. Due to this normal movement, paint finishes may develop slight separation lines, finish breaks and seam lines. With use of selected hardwoods and veneers, some grain patterns and wood characteristics (checks, pin knots) as well as seams and joints will remain visible through the paint finish. Over time, there may be a slight color shift, due to exposure to natural and artificial light. These normal conditions are not considered quality defects and are not covered by this warranty.

THIS WARRANTY IS THE EXCLUSIVE WARRANTY OF WOLF HOME PRODUCTS AND IS IN LIEU OF AND WOLF HOME PRODUCTS DISCLAIMS ALL OTHER WARRANTIES, EXPRESS OR IMPLIED, INCLUDING THE IMPLIED WARRANTIES OF MERCHANTABILITY AND FITNESS FOR A PARTICULAR PURPOSE. Some states do not allow the exclusion or limitation of incidental or consequential damages, so the above limitations or exclusions may not apply to you. This warranty gives you specific legal rights and you may also have other rights that vary from state to state.

To submit a claim under this warranty, contact your nearest Wolf Classic cabinets dealer or send a letter explaining the defect along with photos and a dated sales receipt as proof of purchase to the address below.

Wolf Classic Cabinets
Attn: Warranty Claims
20 West Market Street
York, PA 17401
800-234-9653
fax: 717-792-4052
WolfCabinetsWarranty@wolfhomeproducts.com



Wolf strives to ensure all pricing and specifications are accurate. However, in instances where there are discrepancies between 20/20 and the list pricing and product specification guide, use the current guide as the rule. If you are in doubt about any pricing or specifications please contact your Wolf Sales Consultant or Wolf Customer Care.

