

Value Premium

Specifications Guide / Valid thru May 2024

Please Note: Items are subject to change without prior notice. This spec book is missing some updated information, so to stay up to date with product specifications and modification options please use our digital spec book which can be found at <https://ezpricing.fabuwood.com/specbook>

New! Interactive Index

Specbook Updates	III	Base & Wall Accessories	37
Construction Specifications	IV	Wall Accessories	38
Limited 5-Year Warranty	VI	Sink Accessories	40
Door Style	VII	Drawer Accessories	41
Sales Tools	VIII	Vanity Accessories	43
Wall Cabinets	10	Cabinet Accessories	45
12"-18" High Wall Cabinets	10	Fillers	45
15"-24" High & 24" Deep Wall Cabinets	11	Valances	46
30" High Wall Cabinets	12	Posts & Pilasters	47
36" High Wall Cabinets	15	Moldings (8')	49
42" High Wall Cabinets	17	Panels	50
Specialty Wall Cabinets	19	Paint & Touch Up Kits	52
Base Cabinets	21	Hafele Lighting	53
Base Cabinets	21	Under-Cabinet Lighting	53
Tall Cabinets	25	Modifications	57
Tall Pantry Cabinets	25	Cut Modifications	58
Oven Cabinets	26	Pipe Chase	61
Vanity Cabinets	29	Create Columns & Returns	63
Vanities	29	Custom Doors	65
Installed Accessories	31	Customizations	68
Storage Accessories	33	Modifications	68
Waste Solutions	33	Upgrades	71
Base Accessories	34	Loose Parts	72
		Height Alignment Guide	74

Specbook Updates

- **New! Expanded Size offering:**
 - » Dishwasher Return Panel is now available in 1-1/2 width.
SKU: DWR 1-1/2 [pg.50](#)
- **New!** Custom Doors available for online order entry. [pg. 63](#)
 - » New SKUs include Custom Door, Custom Drawer Front, & Custom Deco Panel
- **Additional modifications!** Updates & Pricing [pg. 55](#)
 - » New modification: CHOOSE-INTERIOR [pg.68](#)
- **New Cabinet Accessories:**
 - » TC18FHD Trash Can Full-Height Door [pg. 31](#)
Reminder: Trash Cans with Ball-Bearing Slides have been discontinued
 - » 12" Spice Pull-Out for Base Cabinet [pg. 33](#)
- **Loose Parts:** Restrictor Clips, Loose shelf clips, Door Stem Bumpers [pg.70](#)
- **Hafele Lighting Program** [pg. 53](#):
Hafele under-cabinet and floating shelf lighting now available to add as an accessory for all Framed wall cabinets. Be sure to include the Power supply starter kit(s) per number of zones and any additional Lighting switches as needed.
- **Height Alignment Guide** [pg. 74](#)

Construction Specifications

Doors and Drawer Fronts:

Doors, drawer fronts, rails, and center panels are made with full HDF construction to reduce the possibility of shrinkage.

The 5 piece Hallmark modified full overlay door has a 1/2" thick HDF center panel captured in a 3/4" x 2 1/4" HDF frame and is complimented with a 5 piece recessed panel drawer front. The overlay on top of all wall cabinets has been modified to accept a crown moulding.

Hinges:

Compact Blumotion soft close hinges (Blum model #39C355B.20).

Drawers:

5/8" thick solid wood dovetail drawer box with a 3/8" plywood bottom attached to Tandem plus Blumotion concealed drawer runners (Blum model #563H)

Shelving:

15mm (5/8") thick select veneered wood with matching wood edge-banding is used on all wall and base cabinetry where applicable. The adjustable shelves are supported by plastic self locking shelf clip.

Cabinet Sides, Backs, Tops and Bottoms:

1/2" thick veneered plywood sides and back with natural finished interiors grooved to face frame. The backs are stapled and screwed into place for additional support. Top & Bottom panels are 3/4" thick veneered plywood and grooved into to the side & back panels.

Face Frame:

3/4" x 1 1/2" solid wood stiles and rails jointed with glue and dowels. Back of face frames are grooved to accept side panels. The Hallmark face frame is engineered so that the bottom of all base and wall cabinets are flushed with the top inside edge of the face frame creating a custom look.

Toe Kick:

3/4" x 4 1/2" select unfinished plywood* toe kick is added to each assembled cabinet. Additional 1/4" 8-foot lengths of toe kicks are available in matching colors to our cabinetry.

Panel Beams:

2 1/2" x 1/2" plywood* panel beam is fastened into a dovetail groove at the top of each base cabinet to ensure a straight fully integrated side, and for use of support and mounting of a countertop.

* May come in finish other than natural ply, this does not denigrate the quality of material or structure of the cabinet.

Construction Specifications

- 1 Full HDF construction for door and drawer front stiles and rails are constructed with mortise and tenon joints.
- 2 Compact Blumotion soft-close mechanism integrated in concealed six-way adjustable hinges. Hinges open at 110°
- 3 $\frac{5}{8}$ " solid wood dovetail drawer with a $\frac{3}{8}$ " plywood bottom features Tandem plus Blumotion full-extension concealed drawer runners
- 4 $2\frac{1}{2}$ " interior drawer height.
- 5 $\frac{3}{4}$ " x $1\frac{1}{2}$ " solid wood face frame.
- 6 $\frac{1}{2}$ " select veneered plywood back with a natural finished interior.
- 7 $\frac{1}{2}$ " select unfinished plywood side panels grooved into face frame.
- 8 15mm ($\frac{5}{8}$ " select veneered plywood adjustable shelving with matching wood veneer edge banding.
- 9 $\frac{3}{4}$ " x $4\frac{1}{2}$ " unfinished plywood toe kick attached to cabinet. Matching $\frac{1}{4}$ " toe kick cover to be ordered separately.
- 10 $2\frac{1}{2}$ " x $\frac{1}{2}$ " plywood* panel beams dovetailed into the side panels for strength and stability.
- 11 Base cabinet has $11\frac{7}{8}$ " deep shelf.
- 12 Base has a full overlay door.
- 13 When placing an order, need to select exposed sides; Right, Left or Both.
A $\frac{1}{4}$ " select medium-density fiberboard panel will be applied to the selected side(s), and the side will be near flush finished.
- 14 Wall cabinet has a modified overlay door. Crown can be mounted on the face frame.

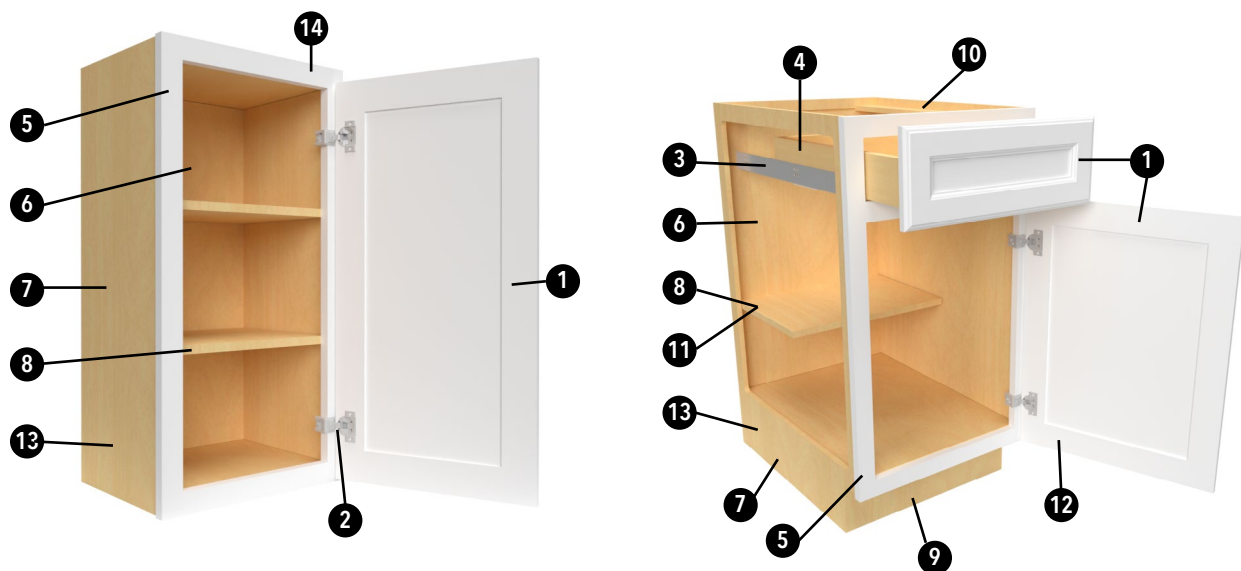

* May come in finish other than natural ply, this does not denigrate the quality of material or structure of the cabinet.

Limited 5-Year Warranty

COVERAGE OF WARRANTY

Fabuwood Cabinetry Corp ("Fabuwood") is pleased to provide the following limited warranty to the first residential purchaser of all cabinets imported to and assembled and sold in the United States by Fabuwood. This warranty does not cover cabinets sold or shipped outside of the United States and Canada. A residential purchaser is a person who purchases and installs the cabinets in a dwelling that is owned and used by that person as a primary or secondary home, or, in the case of a developer or builder, this limited warranty may be assigned to the initial purchaser who uses the dwelling as a primary or secondary home. This warranty, however, is not transferable to subsequent owners of the home. This limited warranty is subject to all limitations, exclusions, disclaimers and procedures set forth herein.

LIMITED 5 YEAR WARRANTY (On Quest and Value Premium series cabinets): Fabuwood warrants to the original purchasing consumer that all Quest and Value Premium series cabinets purchased from Fabuwood will be free from all unnatural defects in material and workmanship in accordance with the Fabuwood quality standards sheet under normal residential use for 5 years from the date of the original purchase or as long as the original purchasing consumer owns the home in which such cabinets are installed, whichever is less.

EXCLUSIONS

THIS WARRANTY SUPERSEDES ANY AND ALL PREVIOUS WARRANTIES BY FABUWOOD AND CONSTITUTES THE EXCLUSIVE REMEDY AGAINST FABUWOOD FOR ALL DEFECTS, DAMAGES AND WORKMANSHIP. THERE ARE NO IMPLIED WARRANTIES EXTENDING BEYOND THE TERMS OF THIS WARRANTY. TO THE MAXIMUM EXTENT PERMITTED BY APPLICABLE LAW, FABUWOOD SHALL NOT BE LIABLE FOR ANY INDIRECT, SPECIAL, PUNITIVE, INCIDENTAL OR CONSEQUENTIAL COSTS, EXPENSES OR DAMAGES (INCLUDING LOST PROFITS), EVEN IF THIS LIFETIME LIMITED WARRANTY IS DEEMED TO HAVE FAILED OF ITS ESSENTIAL PURPOSE. SOME STATES DO NOT ALLOW THE EXCLUSION OR LIMITATION OF INCIDENTAL OR CONSEQUENTIAL DAMAGES, SO THE ABOVE LIMITATION OR EXCLUSION MAY NOT APPLY TO YOU. THIS WARRANTY GIVES YOU SPECIFIC LEGAL RIGHTS, AND YOU MAY ALSO HAVE OTHER RIGHTS, WHICH VARY FROM STATE TO STATE. IT IS POSSIBLE THAT ONE OR MORE OF THE LIMITATIONS AND EXCLUSIONS IN THIS WARRANTY MAY NOT APPLY TO YOU.

LIMITATIONS

This warranty shall become void if the cabinets, cabinetwork, drawer slides or hinges are modified from its original form, improperly installed or damaged prior to or during the installation, or used in any way other than for residential purposes. This warranty covers only parts and materials of the cabinets as supplied by Fabuwood. This warranty does not cover any products used or installed in connection with cabinets, such as gas or electric appliances, countertops, or plumbing fixtures. This warranty does not apply to products installed in locations that do not maintain year-round environmental controls. This warranty shall not apply to damages caused by transportation, storage, dirt, chemicals, exposure to moisture, humidity or excessive heat or cold, nor does it cover the effects arising from normal wear and tear, misuse, neglect, accidents, alterations, improper use or failure to maintain properly, house settling, or acts of God. No installer, retailer, distributor, agent or employee of Fabuwood has the authority to alter the obligations or limitations in this warranty.

QUALITY STANDARDS

This warranty covers all damages and unnatural defects that are deemed as such under the current Fabuwood Quality Standards sheet. The current Fabuwood Quality Standards sheet is available for download in the dealer login section of the Fabuwood website (www.fabuwood.com), which should be reviewed at each time a claim for warranty service is being considered. Fabuwood reserves the right to modify or change the Fabuwood Quality Standards sheet at any time without notice.

DISCLAIMERS

The following is a brief recap of some of the characteristics of the wood and finishes on the cabinets you are about to purchase. Please read them carefully. If some of these characteristics concern you, please choose something else. We bring these characteristics to your attention so you will realize that Fabuwood will not be held responsible for these variations in your cabinetry. It is important to note that wood products claimed as defective are most often the result of atmospheric conditions such as excess moisture and humidity.

Fabuwood strongly recommends testing the intended location of the products for such conditions prior to installation.

WOOD AND COLOR VARIATIONS: Wood is a product of nature, and since no two trees are alike, cabinets may vary in color, texture and grain. Wood characteristics naturally occurring such as variations in color, grain, mineral streaks, pinholes and knots are not considered defects. Color variations in cabinets are also a natural occurrence due to species, age, character of cabinets, and exposure to UV light, smoke, certain household cleaners, sunlight, extreme temperatures, and other environmental conditions. For these reasons, new and/or replacement cabinets may not match display samples and/or existing cabinets. This may result in overall color variations, but is not considered a defect.

WOOD DOORS, DRAWER FRONTS, AND FACE FRAMES: Wood by nature will undergo expansion and contraction movements over the years as it compensates and adjusts to ever changing atmospheric humidity and temperature conditions. It is very common for center panels on doors to shrink, expand or move during these changes. Typically, the panel will return to its normal position within a year once it has adjusted to seasonal changes. It is for these same reasons that it is very common for doors to warp during these periods. Doors that are warped up to 1/4" are not considered defective. [Note: It is advisable to check if the door was properly installed, since doors that appear warped are very often the result of improper installation.] Painted doors, drawer fronts, and face frames may eventually have visible cracking around the joint areas, and cabinet colors may darken or lighten over time. These variations are considered to be the nature of the material in relation to their environmental exposure and are not covered under this lifetime limited warranty.

PAINTED FINISHES: Plywood is a non-porous, smooth grained wood. Additionally, wood by nature undergoes periods of expansion and contraction while it adjusts to atmospheric conditions mentioned above. As such, finish stress lines may become visible on painted cabinets especially at the joints. Any such occurrence is not considered a defect.

GLAZED FINISHES: A glazed finish by character is an uneven finish. Some edges and profiles will be larger than others and glazing may vary cabinet to cabinet, door to drawer and item to item. This may result in overall color, texture, and finish variations but these are not considered defects.

WARRANTY PERFORMANCE

If a defect does occur within the terms and conditions of this warranty such defective part will be repaired or replaced by Fabuwood at its sole discretion. Fabuwood will not provide or pay for the cost of removal of defective product, transportation of defective, repaired or replaced product or installation of repaired or replaced product. If it is not commercially feasible to repair or replace a defective product, we may refund the original price paid by you for the defective product, or provide a credit towards a similar type of product sold by us. Fabuwood will not be responsible for any shipping damages to the defective, replaced or repaired product. If defective item has been discontinued or is not available at the time, Fabuwood reserves the right to replace the item with the most similar item available in Fabuwood's inventory at that time. Fabuwood reserves the right to alter design, specifications and material without obligation to make similar changes to products previously manufactured. Fabuwood cannot guarantee that the finish of any replacement will exactly match the finish and appearance of the defective item due to the natural ageing process of the wood and finishes of the cabinets. Fabuwood may require at its discretion that the customer submit a clear photo, or that a company representative inspect the item being claimed before honoring this warranty.

CLAIMS

To submit a claim covered under this warranty, the claim must be filed through Fabuwood's EZ pricing system by the original Fabuwood-authorized dealer. In case the original dealer cannot be identified, or they have closed down, the warranty claim, must be emailed to customerservice@fabuwood.com. The email should explain the issue and include pictures showing the claimed defects. Feel free to call 201-432-6555 ext. 1 for assistance.

NOTE

Please do not send back any items to Fabuwood prior to receiving proper authorization from customer service. Fabuwood takes no responsibility on any items sent back to Fabuwood without proper return authorization.

Last Modified: 01/26/2023: Change of limited warranty duration from 5-years to the original purchaser of the cabinetry for as long as they own their home.

Door Style

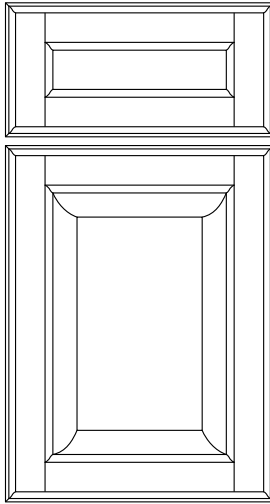

HALLMARK

COLOR	FINISH
Frost	Paint

- Full overlay door with modified overlay on wall cabinets.
- Stiles and rails are HDF $\frac{3}{4}$ " thick and $2\frac{1}{4}$ " wide.
- Constructed with mortise and tenon joints.
- $\frac{1}{2}$ " thick HDF raised center panel.
- 5-piece recessed panel drawer front matches door design.
- Compact Blumotion Soft Close Hinges (Blum Model #39C.355B.20)
- Tandem Plus Blumotion Concealed Drawer Runners (Blum Model #563H)

Sales Tools

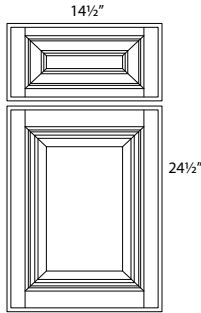

DOOR SAMPLES WITH DRAWER FRONT

ITEM	DESCRIPTION
SDHF	HALLMARK FROST

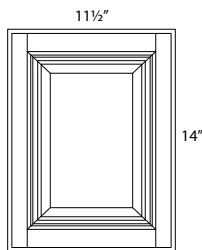

SMALL DOOR SAMPLES

ITEM	DESCRIPTION
SDHF-2	HALLMARK FROST



SELLING CENTER

ITEM	DESCRIPTION
DEALER SELLING CENTER	FABUWOOD SELLING CENTER
ACRYLIC LOGO 38X8	FABUWOOD ACRYLIC LOGO DISPLAY SIGN 38"X8"

- Fabuwood Selling Center Display comes with:*
- three (3) Base Cabinets, 12"W x 16"D
 - FSC B12 include the following finishes: Illume Catalina Bianco Gloss, Allure Galaxy Nickel, & Quest Discovery Frost
 - Full set of Large Sample Doors
 - One of each molding chain for Allure, Quest

- Includes one Box set each of Color Blocks and Express Color Blocks
- Digital Brochure Keychains (Pack of 25)
- Pack of 25 Style Guide Brochures
- Acrylic Logo Sign included and available for separate purchase



Fabuwood Logo Sign:

- Now available as a stand-alone item for endless display options. Hang our sign amongst a gallery wall of Fabuwood Sample Doors, or pair with a Fabuwood vignette to create a unique Selling Center tailored to your individual showroom style.
- Acrylic sign predrilled with decorative chrome plated standoffs included.



COLOR BLOCKS

ITEM	DESCRIPTION
COLOR BLOCK	BOX OF COLOR BLOCKS

Sales Tools



Shown with SD

SAMPLE DOOR STAND

ITEM	DESCRIPTION
SAMPLE DOOR STAND	SAMPLE DOOR DISPLAY STAND

- Stand can be easily unassembled and re-assembled for storage or portability to trade shows
- Sample Door Display stand can hold up to nine sample doors
- Will accommodate sizing for all door styles



Shown with SD-2

SAMPLE PACKAGES

ITEM	DESCRIPTION
SMALL SAMPLE PACKAGE	SMALL SAMPLE PACKAGE
DEALER PACKAGE	LITERATURE AND ACCESSORIES

Small Sample Package:

- Full Set of Small Sample Doors (door is 11-1/2" x 14"H)

Dealer Package:

- Full set of Large Sample Doors with Allure & Illume Signature colors (Includes Door & Drawer Front)
- One of each molding chain for Allure and Quest
- Full set of Color Blocks including Allure Signature, Allure Designer, & Illume Signature colors
- Digital Brochure Keychains (Pack of 25)
- Style Guide Brochure (Pack of 25)



DIGITAL BROCHURE

ITEM	DESCRIPTION
DIGITAL BROCHURE QR	QR CODE KEY RING

- Pack of 25 Key Rings

STYLE GUIDE

ITEM	DESCRIPTION
SG23	25PK. 2023 STYLE GUIDE BROCHURE

- Pack of 25 Style Guides



12"-18" High Wall Cabinets

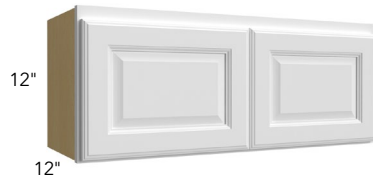

12" HIGH

ITEM
W3012
W3612

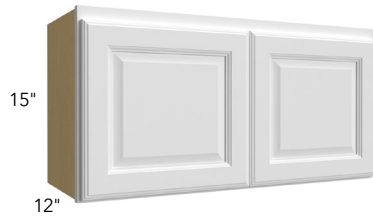

15" HIGH

ITEM
W2115*
W2415
W3015
W3315
W3615



* single door cabinet

* One door only



18" HIGH

ITEM
W2118*
W2418
W3018
W3318
W3618

* One door only

15" - 24" High & 24" Deep Wall Cabinets

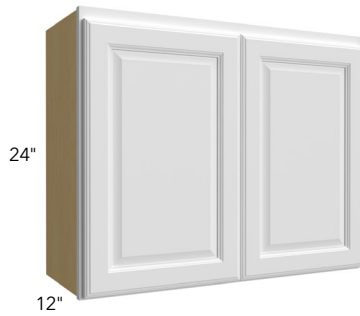

24" HIGH

ITEM
W2424
W3024
W3324
W3624



24" DEEP

ITEM
W301524
W331524
W361524
W301824
W331824
W361824
W302424*
W332424*
W362424*



* Has 1 shelf

30" High Wall Cabinets

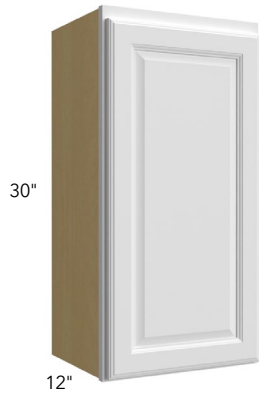

30" HIGH

ITEM

W0930

W1230

W1530

W1830

W2130

- Peninsula cabinet modification [pg. 68](#)

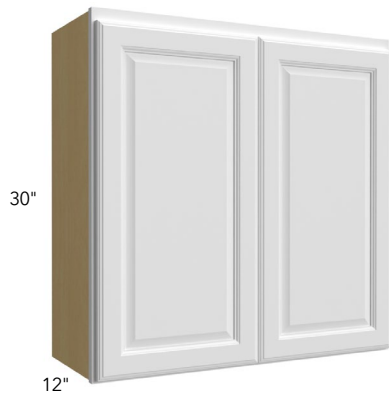

30" HIGH

ITEM

W2430

W2730

W3030

W3330

W3630

- Peninsula cabinet modification [pg. 68](#)

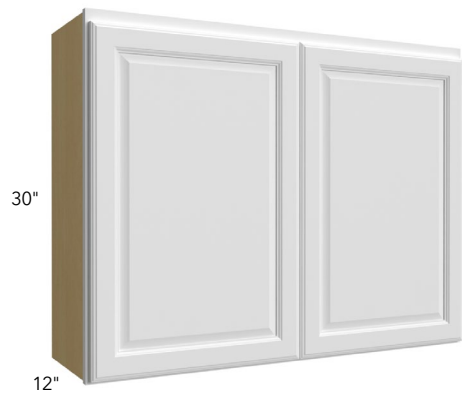

30" HIGH

ITEM

W3930

W4230

- 1 1/2" center stile
- Peninsula cabinet modification [pg. 68](#)

30" High Wall Cabinets

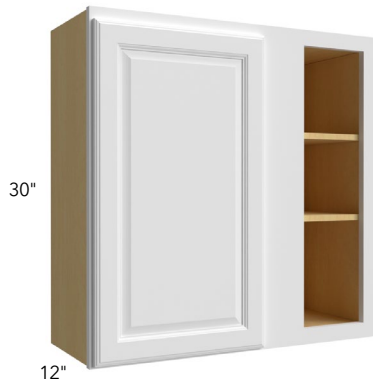

30" SINGLE DOOR BLIND

ITEM

WBC2430

WBC3030

WBC3630

- Must use filler on adjacent side (not supplied)
- Measurements are rounded off to closest 1/8"

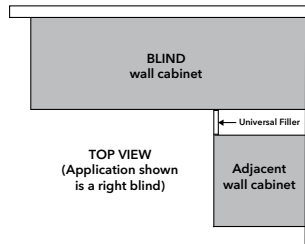

	Act.	Max	Door	Stile	Open (door side)
WBC2430	24"	27"	10 5/8"	6"	7 3/4"
WBC3030	30"	33"	16 3/8"	6"	13 3/4"
WBC3630	36"	39"	22 3/8"	6"	19 3/4"



30" DOUBLE DOOR BLIND

ITEM

WBC4230

- Must use filler on adjacent side (not supplied)
- Measurements are rounded off to closest 1/8"

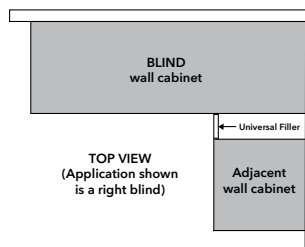

	Act.	Max	Door	Stile	Open (door side)
WBC4230	42"	45"	14 1/8"	6"	25 1/8"

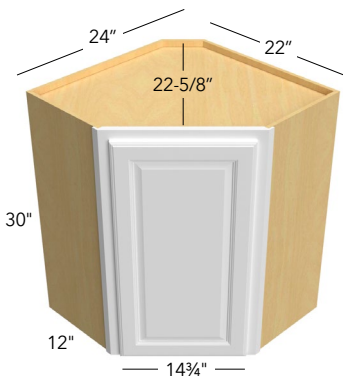

30" DIAGONAL CORNER

ITEM

WDC2430

- Uses 3/8" overlay hinge
- For Lazy Susan see accessories on pg. 22

30" High Wall Cabinets



30" GLASS DOOR

ITEM
GD1230
GD1530
GD1830
GD2430◆
GDD2430*
GD3030◆
GD3630◆

* 14¾" wide for WDC2430 only

◆ Cost is for a single door - must order quantity of 2 doors per cabinet

• Glass doors are pre-installed with clear glass only

36" High Wall Cabinets



36" HIGH

ITEM

W0936

W1236

W1536

W1836

W2136

- Peninsula cabinet modification [pg. 68](#)



36" HIGH

ITEM

W2436

W2736

W3036

W3336

W3636

- Peninsula cabinet modification [pg. 68](#)



36" SINGLE DOOR BLIND

ITEM

WBC2436

WBC3636

- Must use filler on adjacent side (not supplied)
- Measurements are rounded off to closest 1/8"

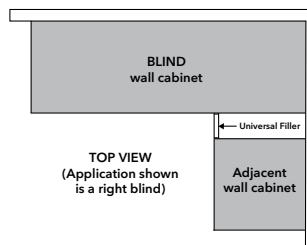

	Act.	Max	Door	Stile	Open (door side)
WBC2436	24"	27"	10 3/8"	6"	7 3/4"
WBC3636	36"	39"	22 3/8"	6"	19 3/4"

36" High Wall Cabinets

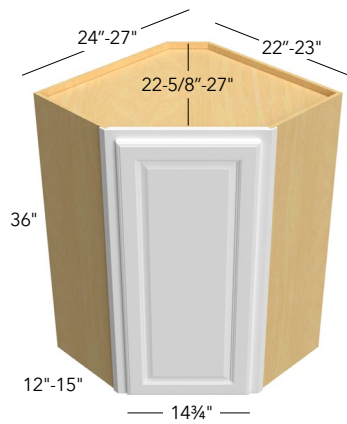

36" DIAGONAL CORNER

ITEM

WDC2436

WDC2736*

- * Cabinet exposed sides come pre-finished with near-flush finished ends.
- Uses 3/8" overlay hinge
- Lazy Susan [pg. 38](#)

36" GLASS DOOR

ITEM

GD1236

GD1536

GD1836

GD2436♦

GDD2436*

GD3036♦

GD3636♦

- * 14 3/4" wide for WDC2436 & WDC2736
- ♦ Cost is for a single door - must order quantity of 2 doors per cabinet
- Glass doors are pre-installed with clear glass only



42" High Wall Cabinets



42" HIGH

ITEM
W0942
W1242
W1542
W1842
W2142

- Peninsula cabinet modification [pg. 68](#)



42" HIGH

ITEM
W2442
W2742
W3042
W3342
W3642

- Peninsula cabinet modification [pg. 68](#)



42" HIGH

ITEM
W3942

- 1½" center stile
- Peninsula cabinet modification [pg. 68](#)

42" High Wall Cabinets



42" SINGLE DOOR BLIND

ITEM

WBC2442

WBC3642

- Must use filler on adjacent side (not supplied)
- Measurements are rounded off to closest 1/8"

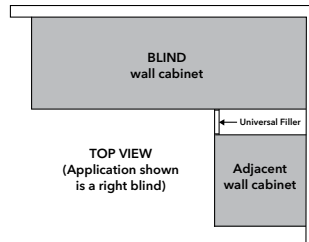

	Act.	Max	Door	Stile	Open (door side)
WBC2442	24"	27"	10 3/8"	6"	7 3/4"
WBC3642	36"	39"	22 3/8"	6"	19 3/4"

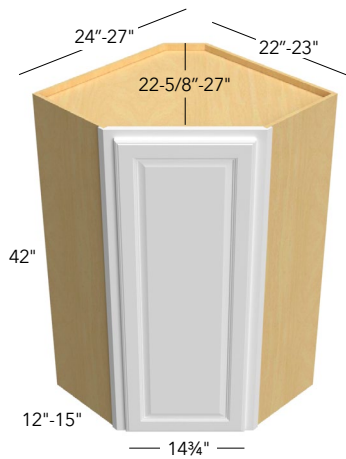

42" DIAGONAL CORNER

ITEM

WDC2442

WDC2742*

- * Cabinet exposed sides come pre-finished with near-flush finished ends.
- Uses 3/8" overlay hinge
- Lazy Susan [pg. 38](#)

42" GLASS DOOR

ITEM

GD1242

GD1542

GD1842

GD2442♦

GDD2442*

GD3042♦

GD3642♦

- * 14 3/4" wide for WDC2442 & WDC2742
- ♦ Cost is for a single door - must order quantity of 2 doors per cabinet
- Glass doors are pre-installed with clear glass only



Specialty Wall Cabinets



DOOR PREPPED FOR GLASS

ITEM
DFG1230
DFG1236
DFG1242
DFG1530
DFG1536
DFG1542
DFG1830
DFG1836
DFG1842
DFG2430*
DFG2436*
DFG2442*
DFG3030*
DFG3036*
DFG3042*
DFG3630*
DFG3636*
DFG3642*

- Glass not included
 - Comes with the center panel removed; vinyl gasket is included for easy installation of glass in the field.
- * Cost is for a single door, need to order quantity of 2 doors per cabinet

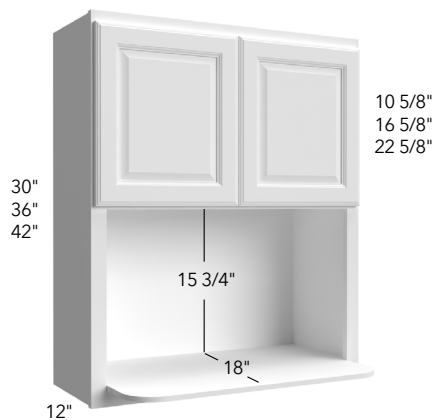

MICROWAVE

ITEM
MW3030
MW3036
MW3042

Specialty Wall Cabinets

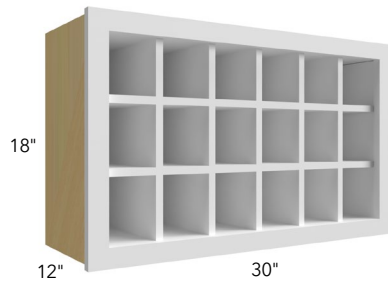

NOTE: DESIGN CHANGE

WINE RACK

ITEM

WR3018

- Finished interior
- 1-½" Framed cabinet construction
- Exterior has 3/4" recess from face frame (all around)
- Interior has 1/4" recess from face frame (all around)
- Fits 18 bottles

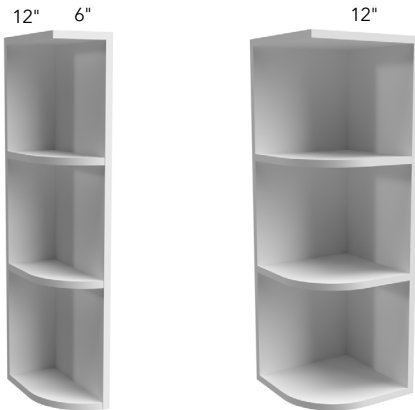

**OEL6 SHOWN
(OPENS TO LEFT SIDE)**

OPEN END

ITEM

OEL630

OEL636

OEL642*

OER630

OER636

OER642*

OE1230

OE1236

OE1242*

* Has three shelves

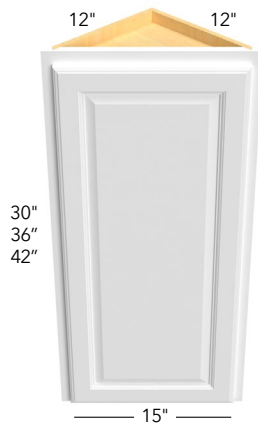

ANGLE END

ITEM

WAE1230

WAE1236*

WAE1242*

- Can use glass door from a Diagonal Corner Wall cabinet - will require a 1" overlay hinge
- Adjustable shelves
- * Has three shelves

Base Cabinets



SINGLE DOOR

ITEM

B09

B12

B15

B18

B21

- B09 accessories [pg. 36](#)
- Peninsula cabinet modification [pg. 68](#)
- Roll Outs [pg. 34](#)



DOUBLE DOOR

ITEM

B24

B27

B30

- Peninsula cabinet modification [pg. 68](#)
- Roll Outs [pg. 34](#)



DOUBLE DOOR & DRAWER

ITEM

B33

B36

B39*

B42*

- * Has 3" center stile
- Roll Outs [pg. 34](#)

Base Cabinets



DRAWER

ITEM
DB12
DB15
DB18
DB24
DB30
DB36

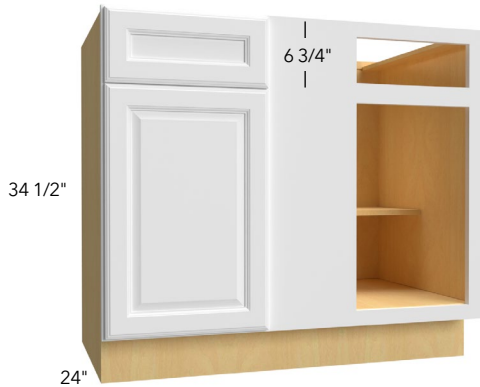

BLIND

ITEM
BLB36/39
BLB42/45
BLB48/51

- Must use filler on adjacent side (not supplied)
- Measurements are rounded off to closest 1/8"

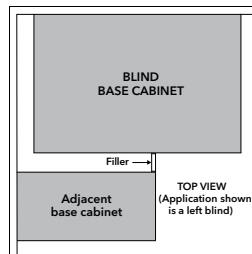

	Act.	Min.	Max	Door	Stile	Open
BLB36/39	27"	36"	39"	10 1/2"	8"	8"
BLB42/45	39"	42"	45"	15 1/4"	10 1/2"	12 3/4"
BLB48/51	48"	48"	51"	21 1/4"	7 1/2"	18 3/4"



DIAGONAL SINK FRONT

ITEM
DSF36*
DSFL36**

- Uses 3/8" overlay hinge
- Tilt Out [pg. 40](#)
- * DSF36 The sink front has a 17" face dimension.
- ** DSFL36 The floor must be ordered separately

Base Cabinets

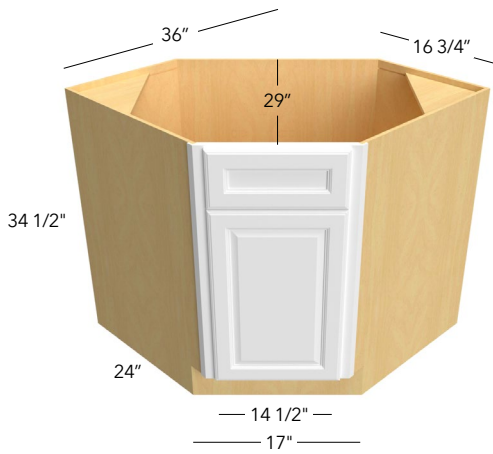

DIAGONAL SINK

ITEM

DSB36

- Uses $\frac{3}{8}$ " overlay hinge
- Tilt Out [pg. 40](#)

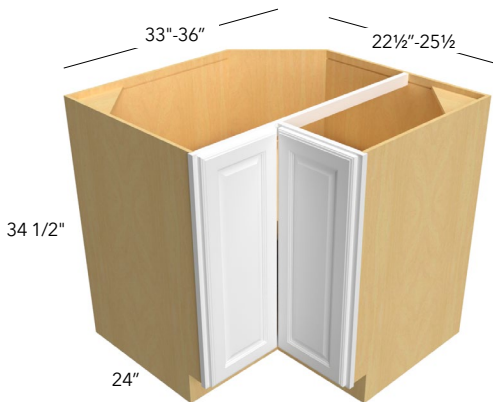

LAZY SUSAN

ITEM

LSB33

LSB36

- Includes two 26" Pie-Cut Lazy Susan Trays
- Once assembled, door cannot be reversed
- Both wooden Lazy Susan trays rotate independently
- Center tray is mounted on 15mm ($\frac{9}{16}$ ") adjustable shelf

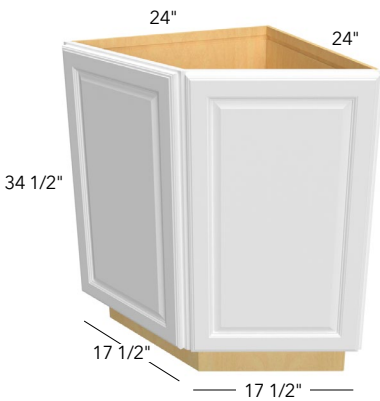

RETURN ANGLE

ITEM

BRA24

- Door width: 17 $\frac{1}{2}$ "
- Adjustable shelving

Base Cabinets



**BASE TRANSITIONAL
RIGHT SHOWN**



TRANSITIONAL

ITEM

BTR12

BTL12

- Cabinet exposed side comes pre-finished with near-flush finished end.
- Cabinet unexposed side comes flush and is not able to have a loose skin or applied finished end. If Interior side needs to be finished, please reach out to Customer Service to have a quote for this modification.

SINK

ITEM

SB24

SB27

SB30

- Tilt Out [pg. 40](#)

SINK

ITEM

SB33

SB36

SB39*

SB42*

- Tilt Out [pg. 40](#)
- * Has a 3" center stile

FARM SINK

ITEM

FS30

FS33

FS36

- Cut opening on job site
- Frame has a full closed top panel Maximum cutout height 12"
- Maximum cutout width 1 1/2" less than the cabinet size

Note: To avoid damage please apply extra care when cutting the front panel.

Tall Pantry Cabinets

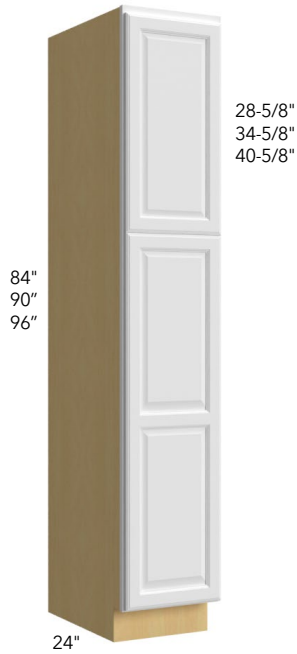

SINGLE DOOR

ITEM

TP152484

TP182484

TP152490

TP182490

TP152496

TP182496

- 84" high - 5 shelves
- 90" & 96" high - 6 shelves
- 18" deep shelves
- Roll Outs [pg. 34](#)

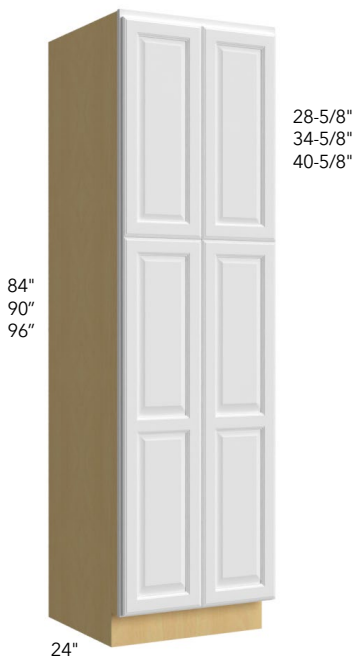

DOUBLE DOOR

ITEM

TP242484

TP302484

TP242490

TP302490

TP242496

TP302496

- 84" high - 5 shelves
- 90" & 96" high - 6 shelves
- 18" deep shelves
- Roll Outs [pg. 34](#)

Oven Cabinets

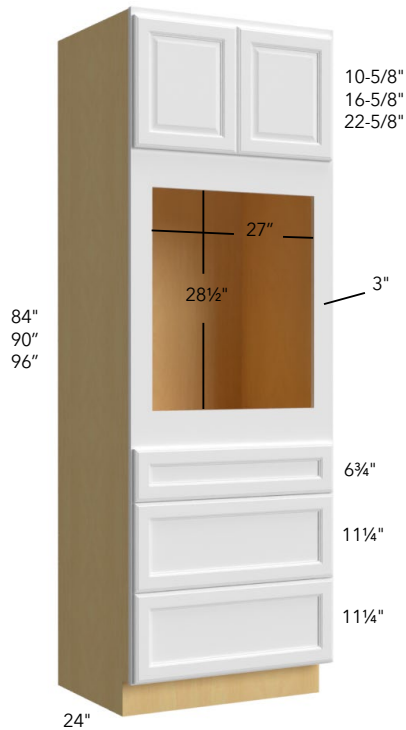

OVEN CABINET SINGLE WITH 3 DRAWERS

ITEM

OC3384S

OC3390S

OC3396S

* Has one shelf in top cabinet.

- 3" Wide rails face frame to be trimmed on site

When using a Single Oven:

- Wide rails face frame to be trimmed on side
- Minimum Width opening 27"
- Maximum **cut out** width 31"
- Minimum Height opening 28 1/2"
- Maximum **cut out** height is 37"
- Maximum **overall** oven Height 37 1/2"

Full panel face frame to be trimmed on site (not by Fabuwood).

Note: To avoid damage to the frame & side panels, please apply extra care when cutting the front panel.

SPECIFICATION FOR OVEN CABINET

Tall Oven Cabinets come with single fixed shelf above top drawer.
 Fixed shelf will be located above the uppermost drawer; location is based on the selected configurations: Single
 Frame is to be trimmed on site to accommodate configuration & appliance needs.

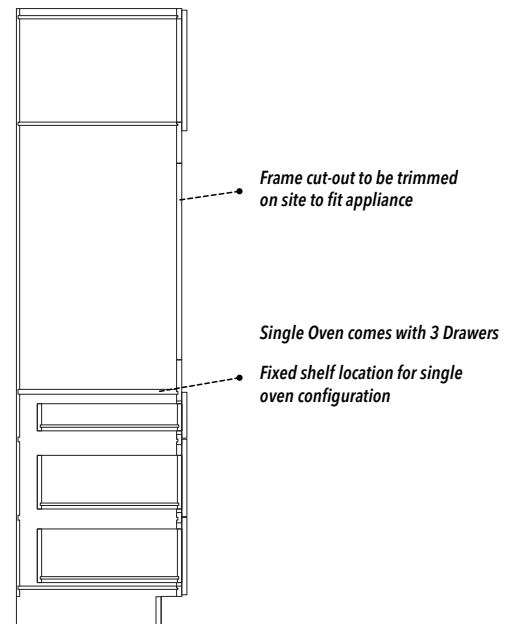

Oven Cabinets

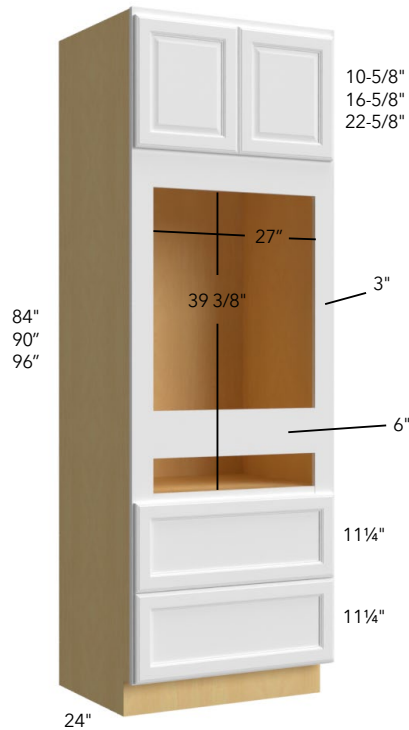

OVEN CABINET COMBO WITH 2 DRAWERS

ITEM

OC3384C

OC3390C

OC3396C

- * Has one shelf in top cabinet.
- 3" Wide rails face frame to be trimmed on site

When using a Combo Oven:

- Wide rails face frame to be trimmed on side
- Minimum Width opening 27"
- Maximum **cut out** width 31"
- Minimum **cut out** height 39 3/8"
- Maximum **cut out** height is 44"
- Maximum **overall** oven Height 44 5/8"

When using two appliances:

Will need to insert a filler and fixed shelf to support top appliance, filler and shelf to be purchased separately

Full panel face frame to be trimmed on site (not by Fabuwood).

Note: To avoid damage to the frame & side panels, please apply extra care when cutting the front panel.

SPECIFICATION FOR OVEN CABINET

Tall Oven Cabinets come with single fixed shelf above top drawer.
Fixed shelf will be located above the uppermost drawer; location is based on the selected configurations: Combo
Frame is to be trimmed on site to accommodate configuration & appliance needs.

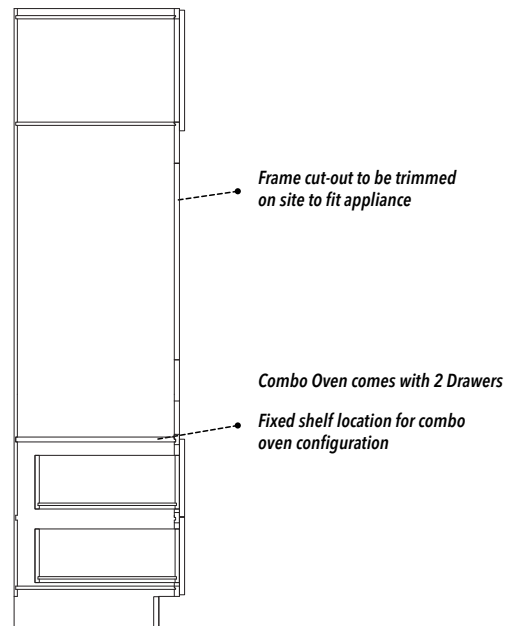

Oven Cabinets

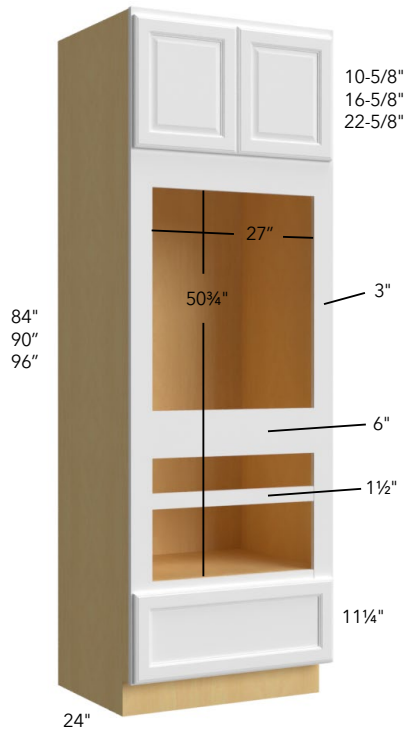

OVEN CABINET DOUBLE WITH 1 DRAWER

ITEM

OC3384D

OC3390D

OC3396D

- * Has one shelf in top cabinet.
- 3" Wide rails face frame to be trimmed on site

When using a Double Oven:

- Wide rails face frame to be trimmed on side
- Minimum Width opening 27"
- Maximum cut out width 31"
- Minimum cut out height is 50 3/4"
- Maximum cut out height is 55 1/2"
- Maximum overall oven Height 56"

When using two appliances:

Will need to insert a filler and fixed shelf to support top appliance, filler and shelf to be purchased separately

Full panel face frame to be trimmed on site (not by Fabuwood).

Note: To avoid damage to the frame & side panels, please apply extra care when cutting the front panel.

SPECIFICATION FOR OVEN CABINET

Tall Oven Cabinets come with single fixed shelf above top drawer.
Fixed shelf will be located above the uppermost drawer; location is based on the selected configurations: Double
Frame is to be trimmed on site to accommodate configuration & appliance needs.

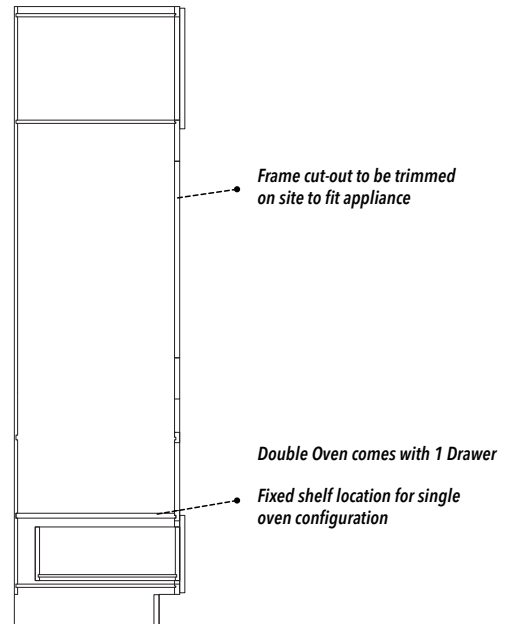

Vanities

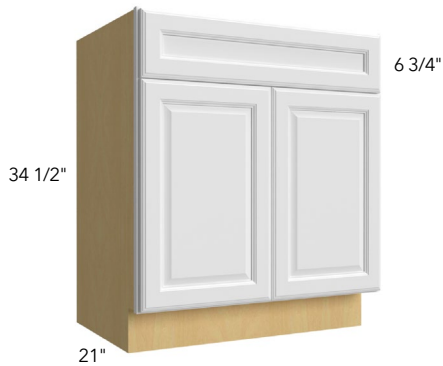

34 1/2" HIGH VANITY SINK BASE

ITEM
VSB24-34
VSB30-34



34 1/2" HIGH VANITY SINK BASE

ITEM
VSB36-34



34 1/2" HIGH VANITY DRAWER BASE

ITEM
VDB12-34
VDB15-34

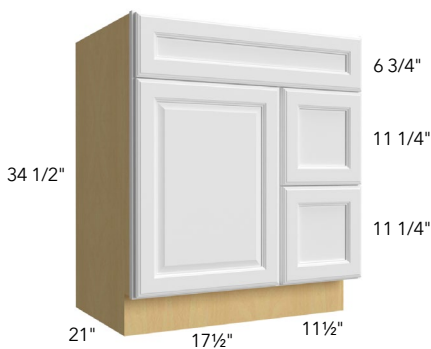

VANITY SINK BASE COMBO

ITEM
VSD30DR
VSD30DL

Need to select drawer on right or left side, cabinet can't be reversed R/L after assembled.

VSD30DR SHOWN

Vanities

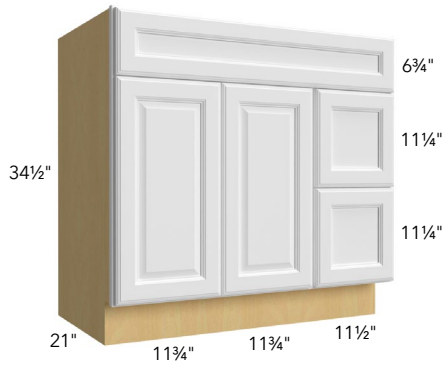

VSD36DR SHOWN

VANITY SINK BASE COMBO

ITEM

VSD36DR

VSD36DL

Need to select drawer on right or left side, cabinet can't be reversed R/L after assembled.

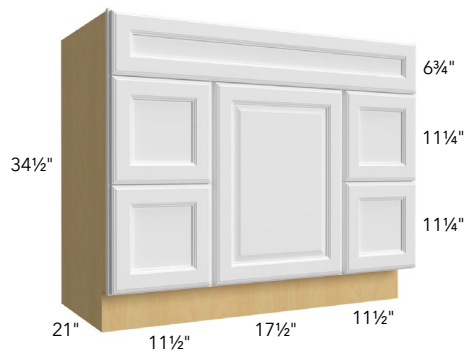

VANITY SINK BASE COMBO

ITEM

VSD42 (34" high)



VANITY SINK BASE COMBO

ITEM

VSD48 (34" high)

Base Cabinets with Installed Accessories

SPICE PULL OUT

ITEM
B09FD-SPO
B09FD-SPOBLUM
B12FD-SPOBLUM

- [Accessory details on pg. 35](#)

SPICE PULL OUT

ITEM
B09FD-TDPOBLUM

- [Accessory details on pg. 36](#)

UTENSIL PULL OUT

ITEM
B09FD-UPO

- [Accessory details on pg. 36](#)

ROLLOUT DRAWERS - PARTIAL EXTENSION

ITEM
B12-1RODE
B12-2RODE
B15-1RODE
B15-2RODE
B18-1RODE
B18-2RODE
B21-1RODE
B21-2RODE
B24-1RODE
B24-2RODE
B27-1RODE
B27-2RODE
B30-1RODE
B30-2RODE
B33-1RODE
B33-2RODE
B36-1RODE
B36-2RODE
B42-1RODE
B42-2RODE
B42-3RODE
B42-4RODE

UTENSIL KNIFE BLOCK PULL OUT

ITEM
B12FD-UKBPOBLUM

- [Accessory details on pg. 36](#)

TRASH CAN PULL OUT

ITEM
B15-TC
B18-TC
B21-TC
B15FD-TC
B18FD-TC
B21FD-TC

- [Accessory details on pg. 33](#)

ROLLOUT DRAWERS - FULL EXTENSION

ITEM
B12-1RODH
B12-2RODH
B15-1RODH
B15-2RODH
B18-1RODH
B18-2RODH
B21-1RODH
B21-2RODH
B24-1RODH
B24-2RODH
B27-1RODH
B27-2RODH
B30-1RODH
B30-2RODH
B33-1RODH
B33-2RODH
B36-1RODH
B36-2RODH
B42-1RODH
B42-2RODH
B42-3RODH
B42-4RODH

- Roll out drawers will be assembled and installed according to the quantity purchased. For custom height-placement, please email orders@fabuwood.com. A \$100 modification surcharge will apply to all custom requests.

Tall Pantries with Installed Accessories

ROLLOUT DRAWERS - PARTIAL EXTENSION

ITEM
TP152484-2RODE
TP152484-3RODE
TP152484-4RODE
TP152490-2RODE
TP152490-3RODE
TP152490-4RODE
TP152496-2RODE
TP152496-3RODE
TP152496-4RODE
TP182484-2RODE
TP182484-3RODE
TP182484-4RODE
TP182490-2RODE
TP182490-3RODE
TP182490-4RODE
TP182496-2RODE
TP182496-3RODE
TP182496-4RODE
TP242484-2RODE
TP242484-3RODE
TP242484-4RODE
TP242490-2RODE
TP242490-3RODE
TP242490-4RODE
TP242496-2RODE
TP242496-3RODE
TP242496-4RODE
TP302484-2RODE
TP302484-3RODE
TP302484-4RODE
TP302490-2RODE
TP302490-3RODE
TP302490-4RODE
TP302496-2RODE
TP302496-3RODE
TP302496-4RODE

ROLLOUT DRAWERS - FULL EXTENSION

ITEM
TP152484-2RODH
TP152484-3RODH
TP152484-4RODH
TP152490-2RODH
TP152490-3RODH
TP152490-4RODH
TP152496-2RODH
TP152496-3RODH
TP152496-4RODH
TP182484-2RODH
TP182484-3RODH
TP182484-4RODH
TP182490-2RODH
TP182490-3RODH
TP182490-4RODH
TP182496-2RODH
TP182496-3RODH
TP182496-4RODH
TP242484-2RODH
TP242484-3RODH
TP242484-4RODH
TP242490-2RODH
TP242490-3RODH
TP242490-4RODH
TP242496-2RODH
TP242496-3RODH
TP242496-4RODH
TP302484-2RODH
TP302484-3RODH
TP302484-4RODH
TP302490-2RODH
TP302490-3RODH
TP302490-4RODH
TP302496-2RODH
TP302496-3RODH
TP302496-4RODH

• Roll out drawers will be assembled and installed according to the quantity purchased. For custom height-placement, please email orders@fabuwood.com. A \$100 modification surcharge will apply to all custom requests.

Waste Solutions

TC15 BLUM



TC18 BLUM, TC21 BLUM



TC15FHD BLUM



TC18FHD BLUM, TC21FHD BLUM



TRASH CAN (W/ BLUM SLIDES)

ITEM

TC15 BLUM*

TC18 BLUM

TC21 BLUM

TCV15 BLUM◆

- Tandem plus Blumotion full extension concealed drawer runners
- Cabinet not included, cabinet must be ordered separately
- 2 - 35 qt. cans included
- * Single 35 qt. can + one bags bin
- ◆ Smaller depth for vanity cabinets 21" deep

TRASH CAN FULL HEIGHT DOOR (W/ BLUM SLIDES)

ITEM

TC15FHD BLUM*

TC18FHD BLUM

TC21FHD BLUM

- Tandem plus Blumotion full extension concealed drawer runners
- Cabinet not included, cabinet must be ordered separately
- 2 - 50 qt. can included
- Includes installation
- Not for ADA cabinet use
- FULL-DOORS modification is required
- * Single 50 qt. can + one bags bin

Base Accessories



ROLL OUT (PARTIAL EXTENSION BLUM SLIDES)

ITEM

ROD-B15 BLUM E

ROD-B18 BLUM E

ROD-B21 BLUM E

ROD-B24 BLUM E

ROD-B27 BLUM E

ROD-B30 BLUM E

ROD-B33 BLUM E

ROD-B36 BLUM E

- Cabinet not included
- Price is for a single Roll Out drawer
- Blumotion partial extension concealed drawer runners
- Drawers are adjustable
- Can be used for pantries

Increased depth of Rollout drawers are by custom request only. Custom quote required.



ROLL OUT (FULL EXTENSION BLUM SLIDES)

ITEM

ROD-B15 BLUM H

ROD-B18 BLUM H

ROD-B21 BLUM H

ROD-B24 BLUM H

ROD-B27 BLUM H

ROD-B30 BLUM H

ROD-B33 BLUM H

ROD-B36 BLUM H

- Cabinet not included
- Price is for a single Roll Out drawer
- Blumotion full extension concealed drawer runners
- Drawers are adjustable
- Can be used for pantries

Increased depth of Rollout drawers are by custom request only. Custom quote required.

Base Accessories



TWO-TIER COOKWARE ORGANIZER

ITEM

CWO-B18 BLUM

CWO-B24 BLUM

- Cabinet not included
- Full-extension Blum slides
- Pegboard bottoms
- 4 Press-in pegs included



3" TOWEL BAR PULL OUT

ITEM

TBPO-BF3

- Filler & Overlay Filler are required and need to be ordered separately
- 2 Towel bars
- Single static shelf with chrome wire accents
- UV coated maple wood
- Installed on site
- Installed between two cabinets
- Full-extension, ball-bearing slides with soft-close



SPICE PULL OUT BASE

ITEM

SPO-B9*

SPO-B9 BLUM

SPO-B12 BLUM

- Cabinet not included, cabinet must be ordered separately
- FULL-DOORS modification is required
- Chrome rails
- Adjustable shelves
- UV coated maple wood
- * Full extension ball-bearing slides (not soft-close)

Base Accessories



UTENSIL PULL OUT BASE 9" (W/ BLUM SLIDES)

ITEM

UPO-B9 BLUM

- Cabinet not included, cabinet must be ordered separately
- FULL-DOORS modification is required
- Chrome rails
- Adjustable shelves
- UV coated maple wood
- Features Blumotion soft-close drawer slides



UTENSIL & KNIFE PULL OUT

ITEM

UKBPO-B12 BLUM

- Cabinet not included, cabinet must be ordered separately
- FULL-DOORS modification required
- Knife block features flex rod technology that adjust to securely hold knives
- Chrome rails
- Adjustable top shelf
- 2 qt. removable stainless steel bin included
- 4 flexible plastic cutting mats included
- UV coated maple wood
- Features Blumotion soft-close drawer slides



TRAY DIVIDER PULL OUT BASE 9" (W/ BLUM SLIDES)

ITEM

TDPO-B9 BLUM

- Cabinet not included, cabinet must be ordered separately
- FULL-DOORS modification is required
- UV coated maple wood
- Features Blumotion soft-close drawer slides

Base & Wall Accessories



SPICE PULL OUT BASE FILLER

ITEM

SPO-BF3*

SPO-BF6*

SPO-BF3 BLUM

SPO-BF6 BLUM

- *Filler & Overlay Filler are required and need to be ordered separately*
- *Chrome rails*
- *Adjustable shelves*
- *UV coated maple wood*
- *Installed on site*
- *Installed between two cabinets*
- *Not for ADA cabinet use*
- *Wall filler 30" high is recommended instead of a base filler, requires to build toe kick separately*

* *Full extension ball-bearing slides (not soft-close)*



SPICE PULL OUT WALL FILLER

ITEM

SPO-WF330

SPO-WF336

SPO-WF342

SPO-WF630

SPO-WF636

SPO-WF642

- *Filler & Overlay Filler are required and need to be ordered separately*
- *Chrome rails*
- *Full extension ball-bearing slides (BLUM soft-close slides not available)*
- *Adjustable shelves*
- *UV coated maple wood*
- *Installed on site*
- *Installed between two cabinets*
- *Wall filler 30" high is recommended instead of a base filler, requires to build toe kick separately*

Wall Accessories



LAZY SUSAN

ITEM

PLASTIC
LSP24 30
LSP24 36/42

WOOD
LSW24 30
LSW24 42
LSW27 30*
LSW27 42*

- Adjustable metal post
- 42" lazy susan has 3 trays
- Prepared for installation at job site
- 42" poles can be cut to fit 36" high cabinet
- * 20" trays

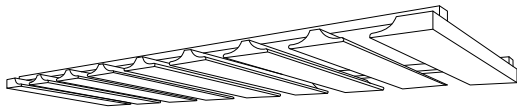

STEMWARE RACK

ITEM

STMW30
STMW36

- Comes unfinished. Product finished per order. May have extended ETA.

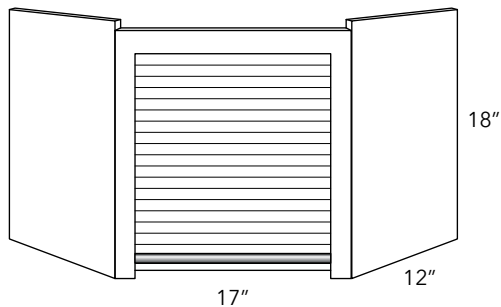

CORNER APPLIANCE GARAGE

ITEM

WDCAG2418

- Comes unfinished. Product finished per order. May have extended ETA.
- Designed to be installed under a diagonal corner wall 24".

Note: Appliance garages ship unassembled. Assembly required for installation on-site.

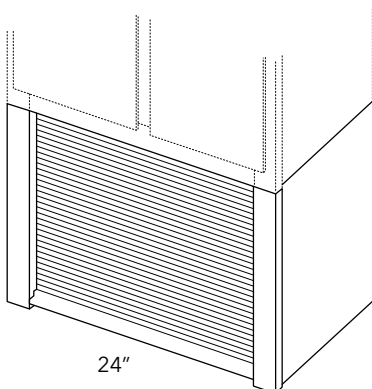

STRAIGHT APPLIANCE GARAGE

ITEM

WAG2418

- Comes unfinished. Product finished per order. May have extended ETA.
- Designed to be placed under a 24" wide wall cabinet.
- Stiles are 2" wide

Note: Appliance garages ship unassembled. Assembly required for installation on-site.

Wall Accessories



STAINLESS STEEL FLOATING SHELF

ITEM

SSFLS36

- *Hanging bracket included*
- *Dimensions:*
 Width: 24", 30", 36"
 Height - 2 1/2"
 Depth - 10"

NOTE: Stainless Steel Floating Shelves have been discontinued. Limited quantities of SSFLS36 available while supplies last.

Sink Accessories



TILT OUT

ITEM
TILTOUT 11"
TILTOUT 14"
TILTOUT 24"

- *White plastic tray*



Drawer Accessories



TIERED DEEP DRAWER

ITEM

DTD-DB30 BLUM

DTD-DB36 BLUM

- For DB30 & DB36 only
- Replaces the original drawer box of cabinet
- UV coated maple wood
- Drawer front not included
- 3 drawer compartments
- Blumotion full extension concealed drawer runners



CUTTING BOARD & KNIFE DRAWER

ITEM

CBKD-B18 BLUM

- For 18" cabinet drawer only
- Replaces the original drawer box of cabinet
- UV coated maple wood
- Up to 4 compartments and built-in knife organizer
- 1 wooden cutting board
- Blumotion full extension concealed drawer runners



CHARGING DRAWER

ITEM

CHD-B18 BLUM

- For 18" cabinet drawer only
- Replaces the original drawer box of cabinet
- UV coated maple wood
- Blumotion full extension concealed drawer runners
- (2) 120V plugs and (2) 201 amp USB ports
- Tamper resistant outlets
- Max current: AC: 12 amps @ 120VAC; USB 2.1 amp & 5 VDC
- Power cord with NEMA 5 - 15 plug
- Integrated cord guide to ensure safe operation
- Shock absorbent mat, black
- Overall safety of this product is determined by its end use

Drawer Accessories



2-TIER CUTLERY DRAWER

ITEM

DCD-15 BLUM

DCD-18 BLUM

DCD-21 BLUM

DCD-24 BLUM

- *UV coated maple wood*
- *Includes complete 3¾" high drawer box*
- *Blumotion full extension concealed drawer runners*



2-TIER CUTLERY COMBO DRAWER

ITEM

DCD-30 BLUM

DCD-36 BLUM*

- *UV coated maple wood*
- *Includes complete 3¾" high drawer box*
- * *For DB36 only*



TRIMMABLE KNIFE DIVIDER

ITEM

DKI-18/24

- *UV coated maple wood*
- *Total height: 2"*
- *¾" plywood bottom*

Vanity Accessories



VANITY OUTLET GROOMING ORGANIZER

ITEM

VGO12FD BLUM

- Cabinet not included, cabinet must be ordered separately
- FULL-DOORS modification required
- 2 removable stainless steel bins included
- 2 shelves with non-skid vinyl lining and acrylic accents
- In-drawer receptacle with (2) 120V plugs
- Tamper-resistant outlets
- Max Current: AC: 12 amps @ 120VAC
- Power cord with NEMA 5 - 15 plug
- Integrated cord guide ensures safe operation
- Drawer stop prevents items from being stored "ON" inside the cabinet
- Its end-use determines the overall safety of this product
- UV coated maple wood
- Not for ADA cabinet use
- Blumotion full extension concealed drawer runners



TRIMMABLE VANITY DRAWER ORGANIZER INSERT

ITEM

VDO

- Designed for 21" or smaller vanity base drawers
- Anti-skid vinyl lining
- Up to 13 compartments
- 2 clear acrylic lids
- UV coated maple wood



VANITY APPLIANCE STORAGE RACK

ITEM

VASR-30

- Designed for 30" vanity base cabinet
- Mounts to inside of right or left door
- Non-skid lining on lower level shelf
- (2) 1.25 qt. stainless steel bins
- UV coated maple wood

Vanity Accessories



VANITY ORGANIZER PULL OUT

ITEM

VOPO-24 BLUM

- Reversible
- 6 Acrylic bins included
- Blumotion full extension concealed drawer runners
- For VSB24-34

**Pull-out's shorter depth is designed for 24" Vanity Sink Base, but will also work in standard depth base cabinets. If used in standard base, there will be additional space in rear of cabinet once unit is installed.*

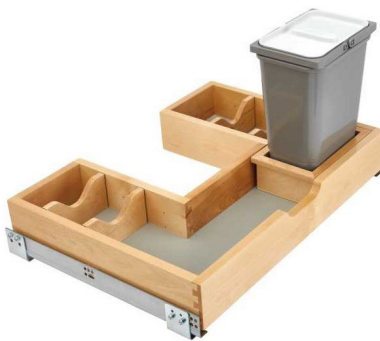

U-SHAPED VANITY SINK BASE PULL OUT

ITEM

UVTCPO-30 BLUM

- Tandem plus Blumotion full extension drawer runners
- Designed for 30" Vanity Sink Base, but works great in standard depth base cabinets as well
- Non-skid vinyl lining
- 4 adjustable dividers
- 8 qt. waste container included

Any accessories can be ordered and installed through Fabuwood

Fillers

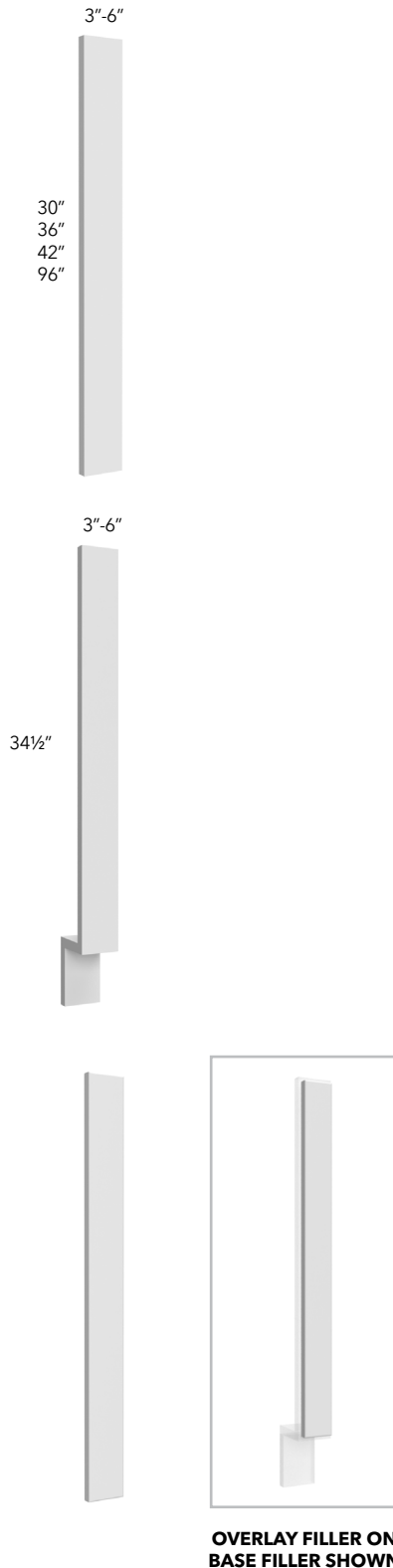

WALL & TALL

ITEM
WF330
WF336
WF342
WF630
WF636
WF642
TF396
TF696

- 2 long edges are finished

BASE

ITEM
BF3
BF6

- Base Fillers are finished on long edges and front face; recessed toe kick area and upper filler area are not finished

OVERLAY

ITEM
OLFBF3
OLFBF6
OLF330♦
OLF336
OLF342
OLF630♦
OLF636
OLF642

- Overlay Base Filler is 29½" high
- Sides of filler are finished
- ♦ Will not fit for a base cabinet

Valances



**OGEE
PROFILE**

STRAIGHT

ITEM

VST96



**OGEE
PROFILE**

ARCHED

ITEM

VAR54

Posts & Pilasters

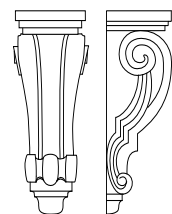
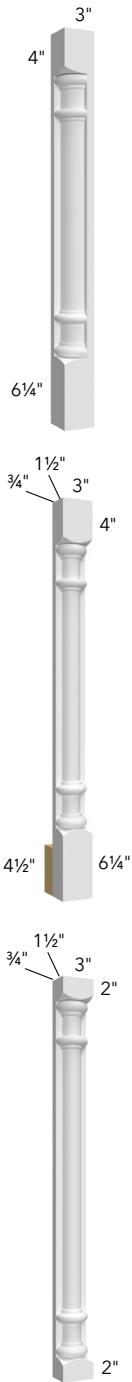

CT
(H6½"xW3¾"xD3½")

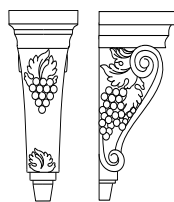

CG
(H10"xW4¾"xD5¼")

CORNER POST

ITEM

CP36

- Must trim 2" from top or bottom

Disclaimer: Pilasters are handmade and may therefore feature inconsistencies in shape or form. These are in no way considered defects.

PILASTER BASE

ITEM

PP-BASE

- Must trim 2" from top or bottom
- Features a toe kick block behind the pilaster

Disclaimer: Posts are handmade and may therefore feature inconsistencies in shape or form. These are in no way considered defects.

PILASTER WALL

ITEM

PP-W30

PP-W36

PP-W42

Disclaimer: Posts are handmade and may therefore feature inconsistencies in shape or form. These are in no way considered defects.

CORBELS

ITEM

CTS

CGS

Disclaimer: Corbels are handmade and may therefore feature inconsistencies in shape or form. These are in no way considered defects.

Moldings (8')

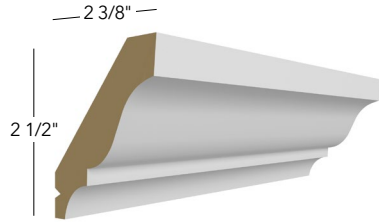

SMALL CROWN

ITEM
CM-1

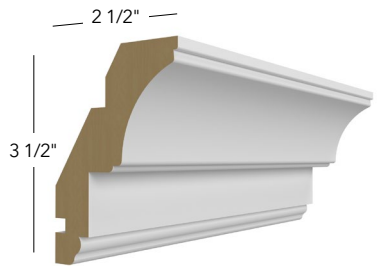

ROYAL CROWN & INLAY

ITEM
TCM*
RM
DM

* Back-mounting cleat included

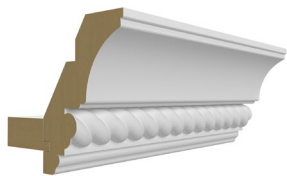

ROPE MOLDING

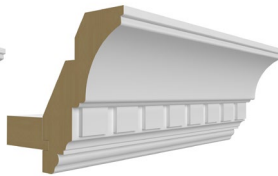

DENTIL MOLDING

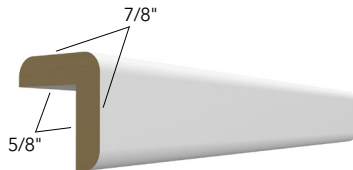

OUTSIDE CORNER

ITEM
OCM8



INSIDE CORNER

ITEM
ICM8

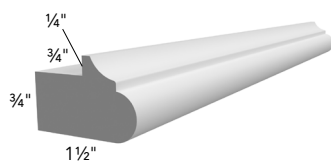

LIGHT RAIL

ITEM
LRM

Moldings (8')



QUARTER ROUND

ITEM

QRM



SCRIBE

ITEM

SM8



BATTEN

ITEM

BM3/4

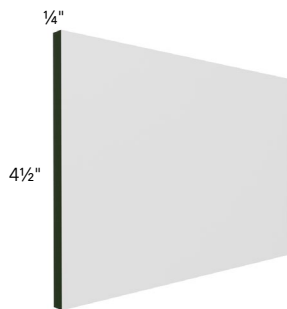

TOE KICK

ITEM

TK8

- Exterior finish matches that of door style ordered
- Moisture Resistant MDF will have visible green core

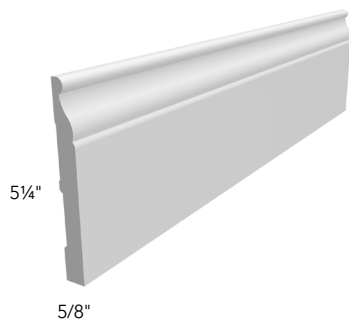

BASE

ITEM

BBM

Panels

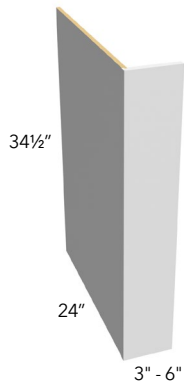

DISHWASHER END PANEL

ITEM
DWR1-1/2
DWR3
DWR6

- Sides are flush finished (no 1/4" reveal)

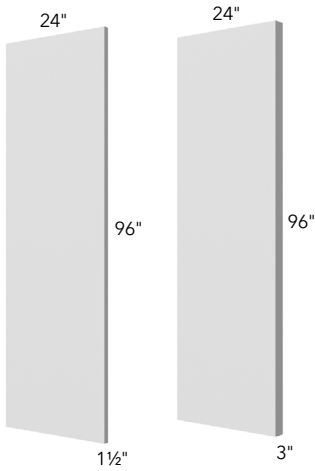

REFRIGERATOR END PANEL WITH RETURN

ITEM
REP1-1/2
REP3

- Sides are flush finished (no 1/4" reveal)

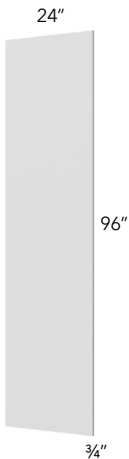

REFRIGERATOR END PANEL

ITEM
REP2496

- Edge banded on both 96" sides.

Panels

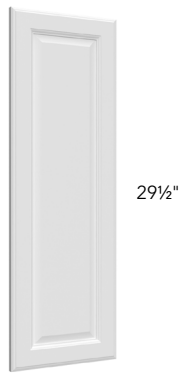

8 1/2", 11 1/2", 14 1/2", 17 1/2", 20 1/2"

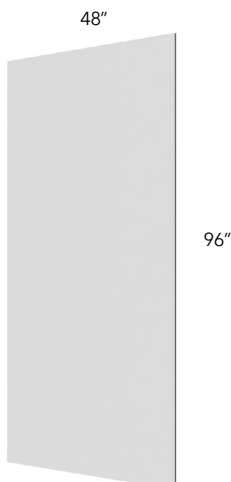

WAINSCOT

ITEM

WP-BASE

WP-W30

WP-W36

WP-W42

WP-T84

WP-T90

WP-T96

- BASE - 23-1/2" X 29-1/2"
- W30 - 11-1/2" X 28-5/8"
- W36 - 11-1/2" X 34-5/8"
- W42 - 11-1/2" X 40-5/8"
- TALL WIDTH - 11-3/4" each door
- TALL BOTTOM DOORS ARE 49-1/4"H

Tall panels can be used for 12"D Pantry by using 2 pieces from the set of 4.

DECO DOOR

ITEM

DD B09FD

DD B12FD

DD B15FD

DD B18FD

DD B21FD

- Door height is 29-1/2"
- Door width is same as door on cabinet

Wainscot Panels may come with hinge holes pre-drilled on the back of the door

PLYWOOD

ITEM

PAN-1/4*

PLY-1/2

PLY-3/4

- Finished 2 sides only
- *Moisture Resistant MDF will have visible green core

Paint & Touch Up Kits



PAINT

ITEM

PAINT

- Available in Frost
- Can be ordered by the Pint or Quart. Quart sizes will be shipped out in the equivalent amount of 1-Pint size cans to fulfill the order.

DISCLAIMER: Fabuwood takes no responsibility for improper application and/or imperfections caused by using this item. Touch-ups & Finishing applications are recommended to be completed by a qualified cabinet installer.



PAINT SPRAY CAN

ITEM

PSC

- Available in Frost only
- Paint Spray Can can be used for general touch-ups. Suggested Uses: Spraying the edges of molding before installation, cosmetic touch-up after installation, spraying the edges of TK8 or loose PAN-1/4 finished end skins.
- Note: Not intended to be used to refinish a cabinet or accessory such as trim moldings.
- Due to the complexity of Fabuwood finishes, Paint Spray Cans are not available for stained finishes.

DISCLAIMER: Fabuwood takes no responsibility for improper application and/or imperfections caused by use of Paint Spray Can. Touch-ups are recommended to be completed by a qualified cabinet installer.



TOUCH UP KIT

ITEM

TOUCH UP KIT

- Includes stick, marker, & scraper

Under-Cabinet Lighting

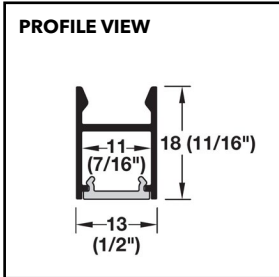

UNDER CABINET LED

ITEM
LED W09
LED W12
LED W15
LED W18
LED W21
LED W24
LED W27
LED W30
LED W33
LED W36
LED W39

- Dimmable. Settings allow for adjustment between Warm White to Cool White lighting
- Light temperature range of 2700-5000K
- LED Lighting bars are designed to be surface-mounted underneath a wall cabinet
- Consists of an aluminum channel housing with diffuser cover
- Requires Power Supply Starter Kit, or Power Supply & Recommended Light Switch (purchased separately).

Note: Installation by a qualified cabinetry installer or electrician is recommended.

Under-Cabinet Lighting



LED FLS30 WALNUT SHOWN

FLOATING SHELF WITH LED

ITEM
LED FLS24
LED FLS30
LED FLS36
LED FLS42
LED FLS48
LED FLS54
LED FLS24 WALNUT
LED FLS30 WALNUT
LED FLS36 WALNUT
LED FLS42 WALNUT
LED FLS48 WALNUT
LED FLS54 WALNUT

- Dimmable. Settings allow for adjustment between Warm White to Cool White lighting
- Light temperature range of 2700-5000K
- Floating shelves include a Light Bar with 6.5ft Lead and a 6.5ft Extension Lead
- LED Light Bar for Floating Shelves ship loose and are to be installed in the field
- Floating Shelves with LED are available in Stock Paint and Stain Finishes, Walnut and are to be specified at time of order. For Finishing to a custom color, must be ordered as Dove or Frost.
- Requires Power Supply Starter Kit, or Power Supply & Recommended Light Switch (purchased separately).

Note: Installation by a qualified cabinetry installer or electrician is recommended.

Under-Cabinet Lighting

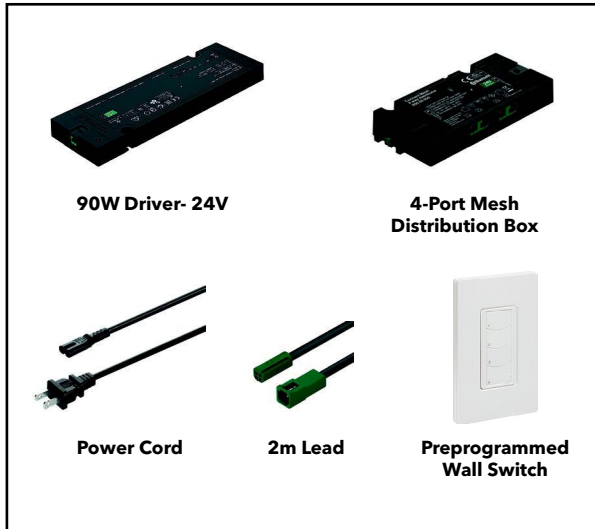

POWER SUPPLY STARTER SET

ITEM
LED SKIT WLS 1Z
LED SKIT WLS 2Z
LED SKIT WLS 3Z
LED SKIT WLS 4Z

- Power Supply Starter sets with Zone Controls come with the following components:
 - 90w Driver, 24V with power cord
 - 2m (6.5ft) Extension Lead to Connect First Light
 - 4-Port Mesh Distribution Box (Bluetooth-enabled, pairs with Wall Switch)
 - One (1) Preprogrammed Wall Switch with Dimmer Function
- Starter Sets should be ordered based on the number of Lighting Zones needed. Starter Kit components quantities are based on zone quantity.
- Each Power Supply Driver requires a 110V standard power outlet
- If more than (4) zones are needed: purchase additional Power Supply Starter Sets depending on additional quantity of zones needed. Additional Wall Switch LED WLS SWITCH is available for purchase.
- Consult the following page or the Ordering Guide for instructions on determining zones and for layout examples.

NOTE: Maximum amount of 10ft per zone is advised. Cabinetry runs greater than 10ft are considered 2 zones (or more).

Installation by a qualified cabinetry installer or electrician is recommended

Zone Control Kit Contents & Qty per number of Zones	1 Zone	2 Zones	3 Zones	4 Zones
40w Driver (24V) with power cord	1	2	3	4
2m (6.5ft) Extension Lead to Connect to First Light	1	2	3	4
4-Port Mesh Distribution Box, Bluetooth Enabled	1	2	3	4
Preprogrammed Wall Switch (Bluetooth Enabled, Leviton Decora	1	1	1	1



ADDITIONAL WIRELESS WALL LIGHT SWITCH

ITEM
LED WLS SWITCH

- Leviton Decora-style Wall Switch with Dimmer Function

Note: Installation by a qualified cabinetry installer or electrician is recommended.

Under-Cabinet Lighting

ORDERING GUIDE

Ordering Loox Kitchen Lighting can be completed within a few steps. We will outline those steps below so that you can specify the products that work best for your kitchen.

DETERMINE ZONES

Determine how many total light zones are in the kitchen; a zone is determined by a continuous run of cabinets. Any separation in the wall cabinets including windows, range hoods, doors, etc. creates a break and may create another zone. If a zone is greater than 10' consider it 2 zones. Make sure there is a 110 V power outlet for each zone either in the cabinet or immediately above the cabinet. See examples of zone illustrations below:

Layout Examples

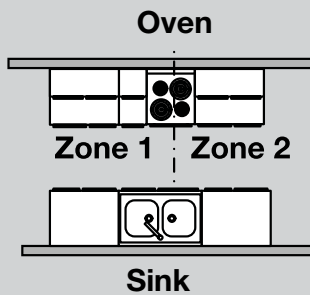

GALLEY

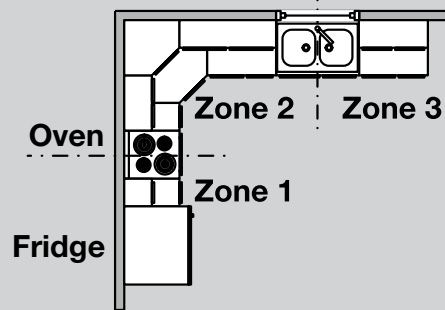

L-SHAPE

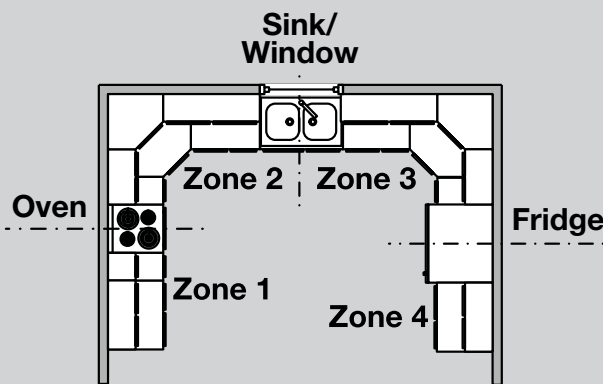

U-SHAPE

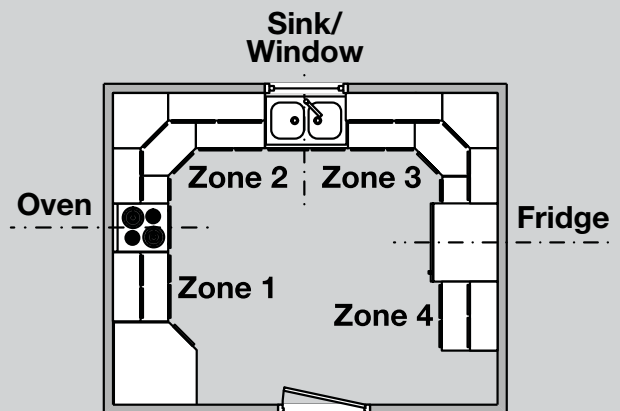

G-SHAPE

Modifications

Cut Modifications

ITEM
CUT-BASE

- Reduce depth of base cabinet (min. depth 12")

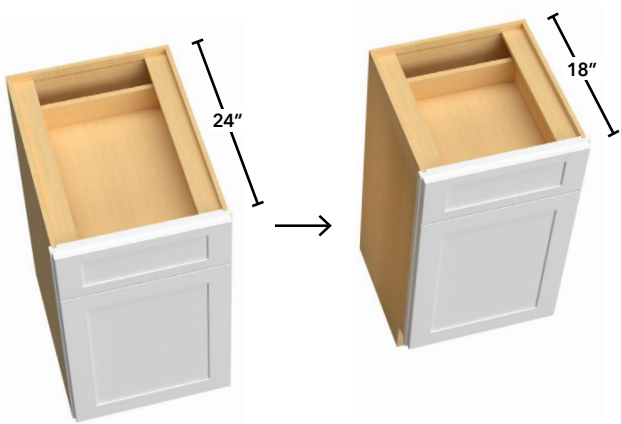

ITEM
CUT-SBASE

- Reduce depth of sink base cabinet (no min.)

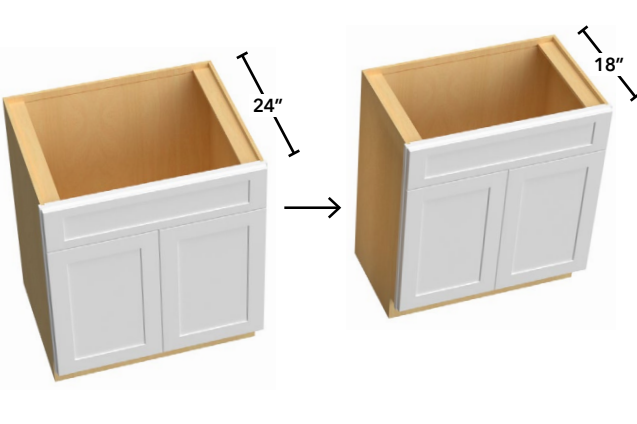

ITEM
CUT-DBASE

- Reduce depth of drawer base cabinet (min. depth 12")

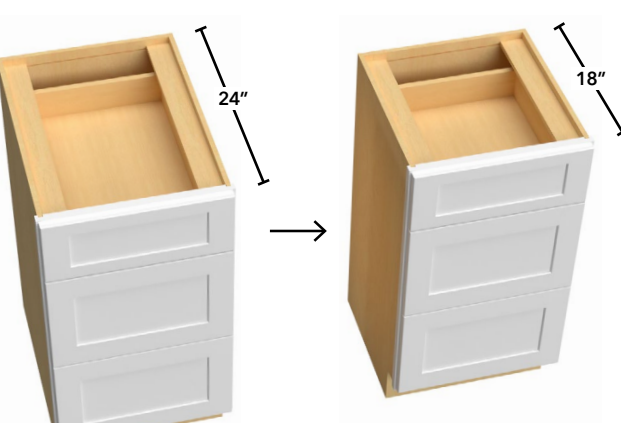

ITEM
CUT-WALL

- Reduce depth of wall cabinet (no min.)

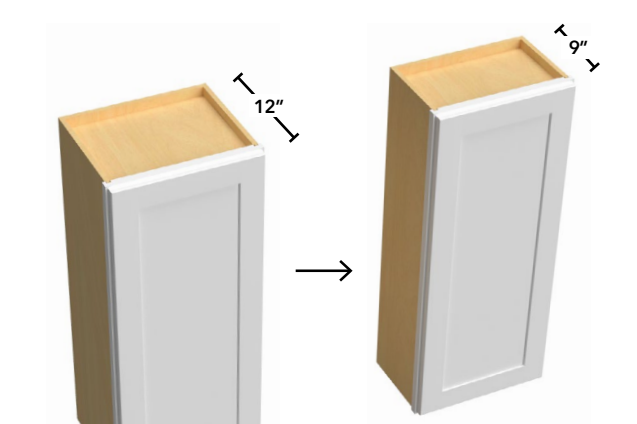

Cut Modifications

ITEM
CUT-TALL

- Reduce depth of tall cabinet (no min.)

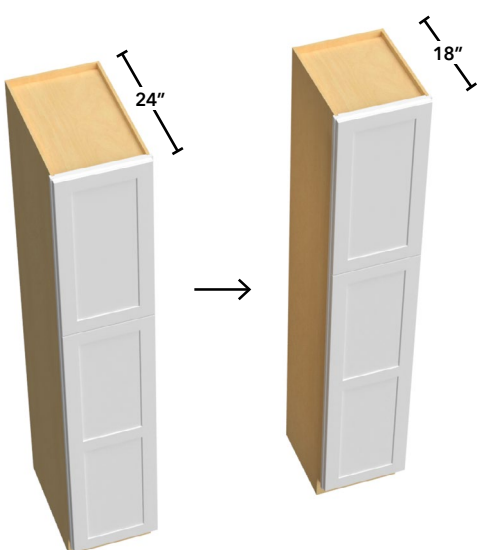

The diagram illustrates a modification to a tall cabinet. On the left, a 3D perspective view shows a cabinet with a depth of 24 inches. An arrow points to the right, where the same cabinet is shown with a reduced depth of 18 inches.

ITEM
CUT-COLUMN

- Reduce depth of column (specify depth)

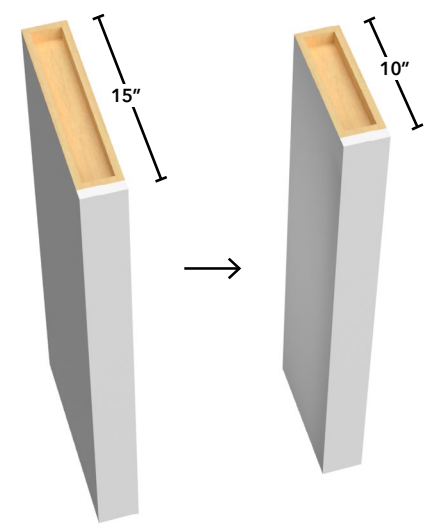

The diagram illustrates a modification to a cabinet column. On the left, a 3D perspective view shows a column with a depth of 15 inches. An arrow points to the right, where the column is shown with a reduced depth of 10 inches.

ITEM
CUT-DOOR

- Cut out center panel of door for glass insert (per door, glass not included)
- MATCH-INTERIOR must be added separately
- Not available for Luna

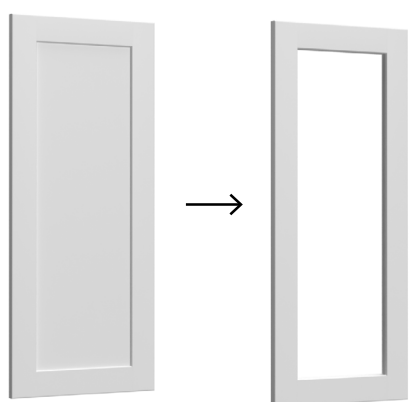

The diagram illustrates a modification to a cabinet door. On the left, a 3D perspective view shows a solid cabinet door. An arrow points to the right, where the door is shown with a rectangular cutout in the center panel, intended for a glass insert.

ITEM
CUT-BASE HEIGHT

- Reduce height of base cabinet by cutting off top drawer (total base height: 28-1/8")
- Designed to create a base cabinet that can be used with a Range Top appliance

NOTE: Modification is only available for Base cabinets with a standard top drawer. Not available for 2-Drawer Base, Farm Sink, or File Drawer.

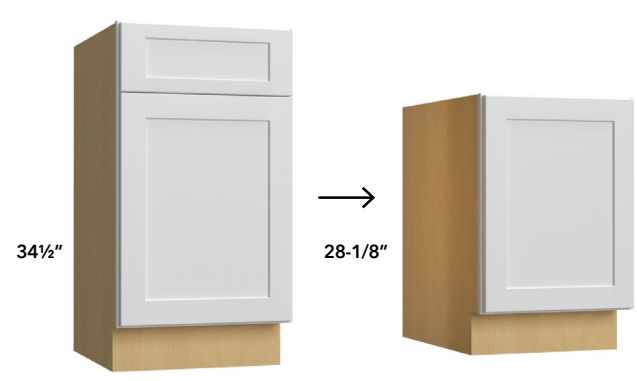

The diagram illustrates a modification to a base cabinet. On the left, a 3D perspective view shows a base cabinet with a total height of 34 1/2 inches. An arrow points to the right, where the cabinet is shown with the top drawer removed, resulting in a total height of 28 1/8 inches.

Cut Modifications

ITEM
CUT-TK

- Reduce toe kick height
- Specify total cabinet height when selecting modification.
- Will ship Toe Kick loose if full height of toe kick is removed.



The diagram illustrates the CUT-TK modification. On the left, a cabinet is shown with a toe kick of 4 1/2 inches. An arrow points to the right, where the same cabinet is shown with a reduced toe kick of 2 inches.

ITEM
CUT-ROD

- Reduce depth of rollout drawer (specify depth of cabinet)
- CUT-ROD modification will be automatically added when CUT-____ depth reduction has been applied to a cabinet with a ROD accessory selected.
- Roll Out Drawer is trimmed from the back to new depth. Back panel will no longer be dovetailed.

Note: to add CUT-ROD on ROD Roll Out Drawers being ordered loose, please contact your Customer Service Teams for assistance.

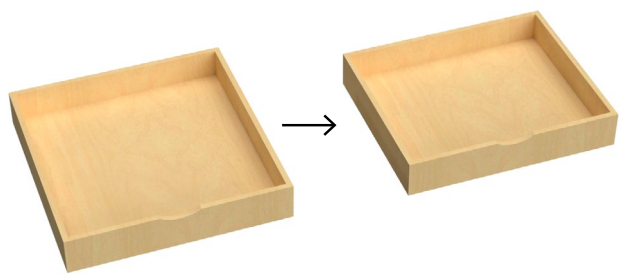

The diagram illustrates the CUT-ROD modification. On the left, a rollout drawer is shown in its original state. An arrow points to the right, where the drawer is shown after being trimmed from the back to a new, shallower depth.

ITEM
CUT-PANEL

- Cut down a panel to any size

Note: cut sides do not include edge-banding.
Contact Customer Service to request application via Custom Shop, or add EDGE-BANDING (QTY per L.F.) as a loose accessory item for field application.

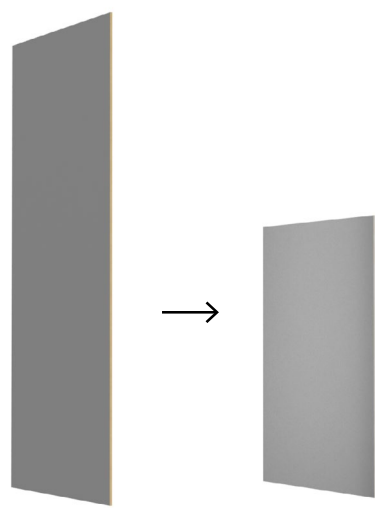

The diagram illustrates the CUT-PANEL modification. On the left, a tall, narrow vertical panel is shown. An arrow points to the right, where the same panel is shown after being cut down to a shorter height.

Pipe Chase

ITEM
CHASE-BASE

- *Make chase in base cabinet*
- **Must supply a drawing for all chase modifications.**

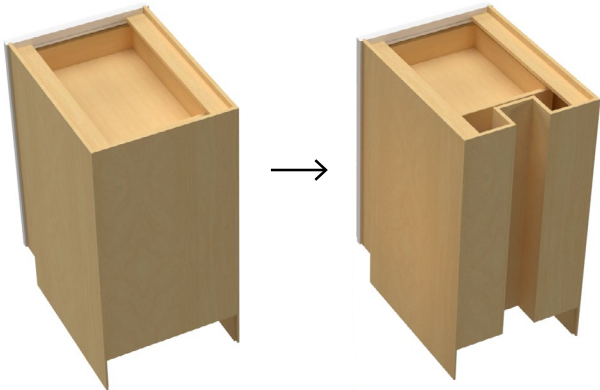

ITEM
CHASE-WALL

- *Make chase in wall cabinet*
- **Must supply a drawing for all chase modifications.**

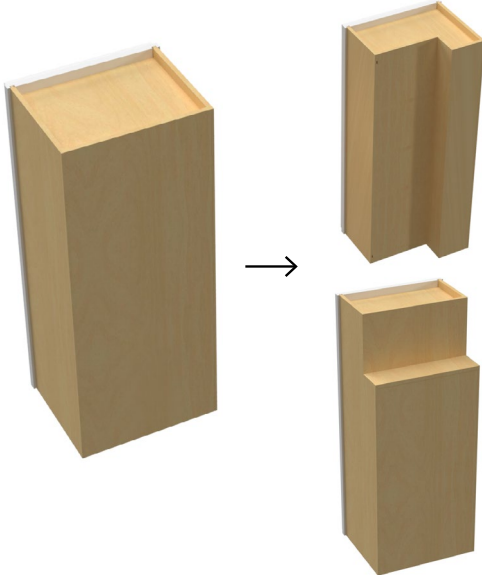

ITEM
CHASE-DBASE

- *Make chase in drawer base cabinet*
- **Must supply a drawing for all chase modifications.**



ITEM
CHASE-TALL

- *Make chase in tall cabinet*
- **Must supply a drawing for all chase modifications.**

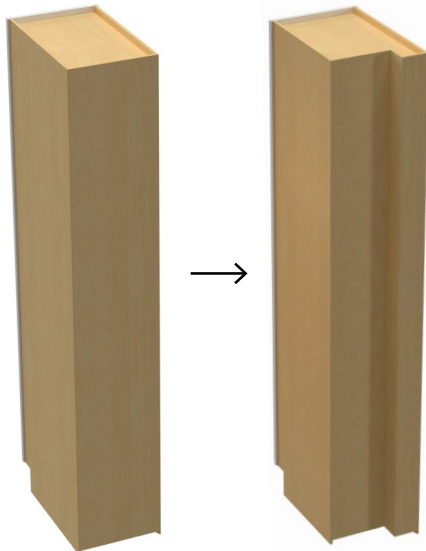

Pipe Chase

ITEM

CHASE-CORNER

- *Make chase in corner cabinet (WDC, WPC & ERB only)*
- **Must supply a drawing for all chase modifications.**

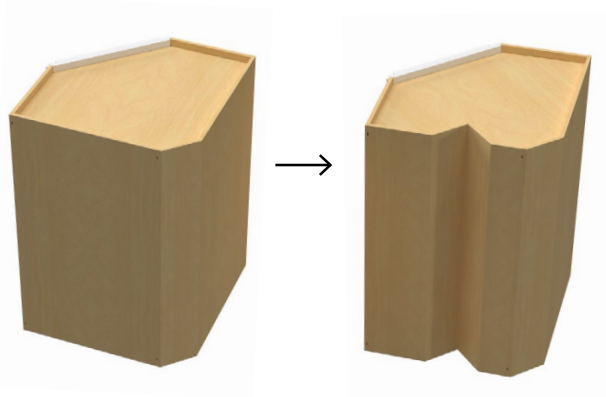

Create Columns & Returns

ITEM

CREATE-RETURN WALL

- Create a return wall filler up to 6"W x 15"D x 42"H (materials incl.)
- Email orders@fabuwood.com for quote



ITEM

CREATE-COLUMN BASE

- Create a 3" column up to 30"D by 34½"H
- Email orders@fabuwood.com for quote

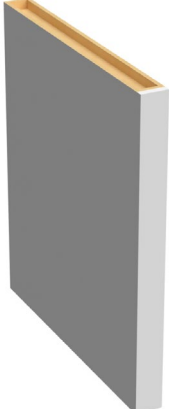

ITEM

CREATE-RETURN TALL

- Create a return tall filler up to 6"W x 30"D x 96"H (materials incl.)
- Email orders@fabuwood.com for quote

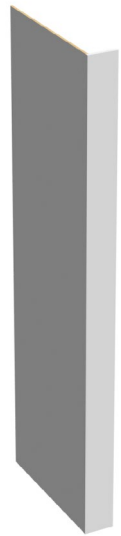

ITEM

CREATE-COLUMN TALL

- Create an oversized column up to 120" high
- Email orders@fabuwood.com for quote

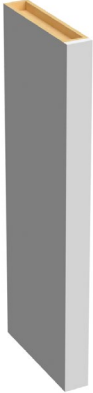

Create Columns & Returns

ITEM
CREATE-COLUMN WALL
<ul style="list-style-type: none">• Create a 3" column up to 15"D x 42"H• Email orders@fabuwood.com for quote

Custom Doors

ITEM

CUSTOM DOOR

CUSTOM DRAWER FRONT

CUSTOM DECO PANEL

Custom Doors, Drawer Fronts & Deco Panels available to order on EZ-Pricing Online.

- Available in 1/16" increments.
- Sizing and availability subject to restrictions & door style selected.

NOTE: Oversize items will receive a Warranty Disclaimer and will not be covered under Fabuwood's Warranty.

Lead Time:

All custom order doors, fronts & deco panels receive extended lead times. Lead times to be advised at time of order placement & may be subject to change.

* CUSTOM DOOR offers the following configuration options:

1. Center Panel:

- Standard Center-Panel
- Prepped for Glass

2. Hinging:

- With hinge holes
- With hinge holes on top as Lift-up
- With no hinge holes

Additional custom options available:

For custom panel configurations, modified stile & rail widths, Wine Cooler Door Overlays or other non-standard requests please email orders@fabuwood.com for pricing.

Refer to Selling Sheet for more information.

Customizations

ITEM

HAMPER

- Install door mounted pull out wood hamper in cabinet (cabinet not incl.)
- 18"high Hamper is constructed of natural plywood
- Comes installed with Ball-Bearing slides



ITEM

REMOVE-DRAWER

- Remove cabinet drawer to create false drawer front



ITEM

INSTALL-ACCES

- Accessories not included
- Email orders@fabuwood.com for quote
- Specify any Third Party accessory for Fabuwood to order & install in a cabinet. Dealer to provide Manufacturer & Model Number.
- Accessory pricing and installation cost vary by item.
- Accessory lead times & availability may vary & are subject to change depending on item(s) selected.

ITEM

EDGE-BAND

- Additional edge banding (price per linear foot)

ITEM

CLOSE-BLIND

- Close open section of a blind wall or base cabinet



Customizations

ITEM

ATTACH-TK

- Attach toe kick on wall cabinet
- Choose from the following options: *FLUSH TK, Recess Right, Recess Left (or a combination or all three options)*

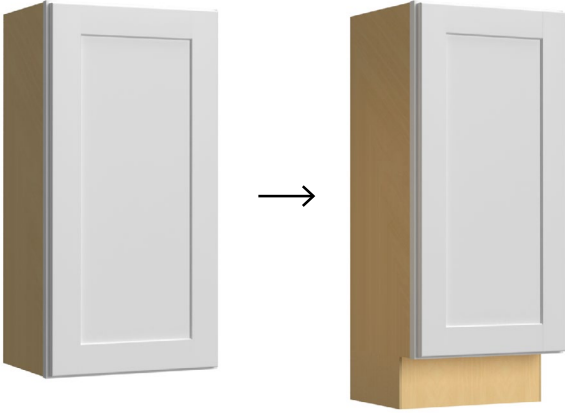

The diagram illustrates the 'ATTACH-TK' customization. On the left, a white wall cabinet is shown without a toe kick. An arrow points to the right, where the same cabinet is shown with a light-colored wooden toe kick attached to its base.

ITEM

INSERT DIVIDER

- Inserts 1/2" vertical trays into standard wall or base cabinet from 9"W - 36"W
- Widths 9" - 18": QTY 1 only
- Widths 21" - 24": QTY 1, 2
- Widths 27" - 30": QTY 1, 2, 3
- Widths 33" - 36": QTY 1, 2, 3, 4

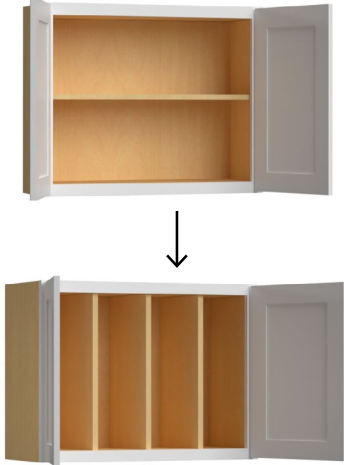

The diagram illustrates the 'INSERT DIVIDER' customization. The top image shows the interior of a cabinet with a single horizontal shelf. A downward arrow points to the bottom image, which shows the same cabinet interior with three vertical dividers inserted, creating four compartments.

Modifications

ITEM

RECESS-TK

- Recess toe kick of base cabinet (must supply a drawing)
- Choose from the following options: Left, Right, Back or a combination of all three.



ITEM

PEN-CABINET

- Create a peninsula cabinet from 2 cabinets
- Peninsula side will include standard Recessed Toe Kick



ITEM

CHOOSE-INTERIOR

- Finish interior of cabinet to selected paint or stain.
- Finished ends must still be specified
- Not available for NDW, WOS, WR/WC/WO cabinets, Vanities, and TP's.



ITEM

INCREASE-BASE

- Increase depth on base cabinet
- Increased depth of Rollout drawers are by custom request only and is not included in modification. Custom quote required.

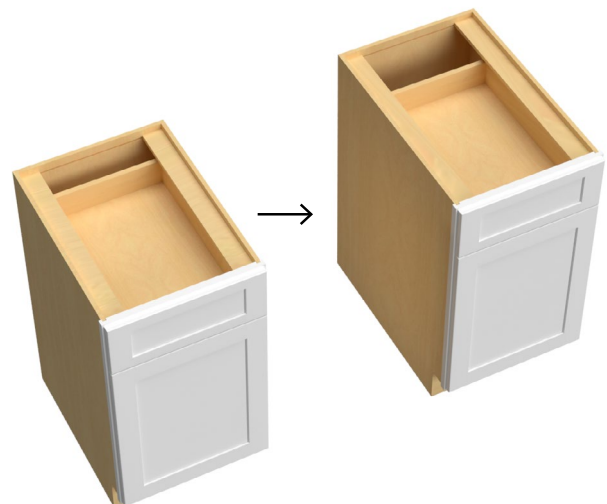

Modifications

ITEM

INCREASE-WALL

- Increase depth on wall cabinet
- Increased depth of Rollout drawers are by custom request only and is not included in modification. Custom quote required.

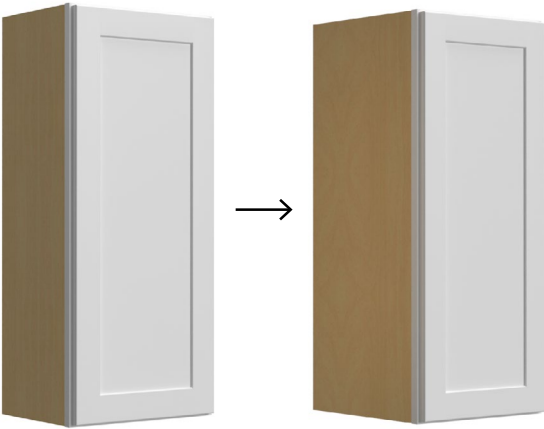

ITEM

MATCH-INTERIOR

- Finish interior of cabinet to match exterior
- Finished ends must still be specified



ITEM

INCREASE-TALL

- Increase depth on tall cabinet
- Increased depth of Rollout drawers are by custom request only and is not included in modification. Custom quote required.

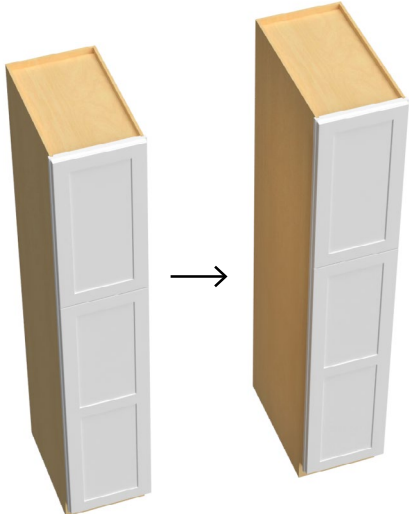

ITEM

CREATE- SQ BOTTOM

- Create square bottom shelf for open end cabinet to allow the use of light rail molding

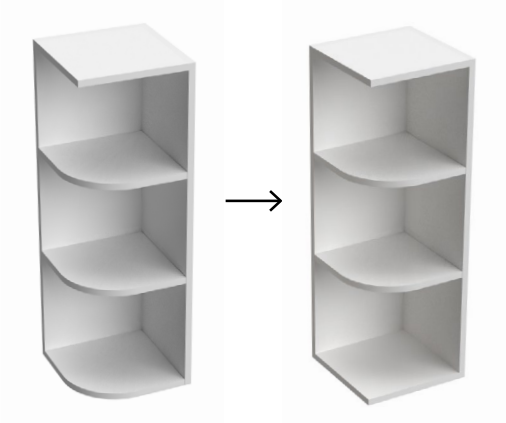

Modifications

ITEM

FLUSH-WALL BOTTOM

- Flush the bottom of a wall cabinet
- Bottom will be finished to match exterior finish

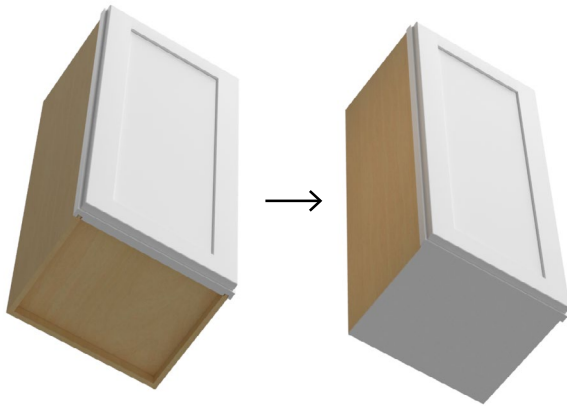

ITEM

FULL-DOORS

- For Full Height Single Door Base - Value Premium Full-Height Base available using FULL-DOORS modification
- For Full Height Double Door Base - Value Premium Full-Height Door Modification is not available in EZPO for cabinets 24" wide and up. CUSTOM DOORS are required for cabinets 24" wide and up. Please email orders@fabuwood.com to request a Full-Height Door Custom Cabinet through custom quotes.



ITEM

FLUSH-TOE KICK

- Flush toe kick of base cabinet to face frame (sides not finished)



ITEM

FILL HINGE-SEAM

- Fills hinge holes with touch-up, seam will still be visible*
- Hinges are removed; doors will still be included and are packaged inside the cabinet

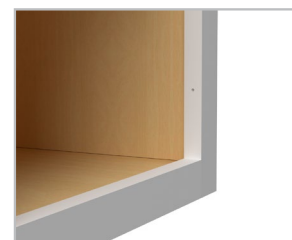

Upgrades

GLAZE

ITEM	DESCRIPTION
GLAZE	Custom glazes available for a charge

Loose Parts

LOOSE PARTS

ITEM	DESCRIPTION
SK BASE	Skin for base cabinet with adhesion
SK MC	Skin for microwave wall cabinet with adhesion
SK TALL	Skin for tall cabinet with adhesion
SK W30	Skin for 30" high wall cabinet with adhesion
SK W36	Skin for 36" high wall cabinet with adhesion
SK W42	Skin for 42" high wall cabinet with adhesion
SK TP12	Skin for 12" deep tall pantry cabinet with adhesion
STEM BUMPER	Individual Stem Bumper

RESTRICTOR CLIPS

ITEM	DESCRIPTION
BLUM-COMPACT RES CLIP 10PK	PACK OF 10 BLUM-COMPACT ANGLE RESTRICTION CLIP
BLUM-LBS RES CLIP 2PK	PACK OF 2 BLUM LSB ANGLE RESTRICTION CLIP

- Compact Angle Restrictor Clip:**
 - BLUM Angle Restriction Clip for COMPACT BLUMOTION and COMPACT CLIP hinges.
 - Reduces swing from 110-deg to 86-deg
 - One clip required per every two hinges. For a 30" high door, use 1 clip. For 36" to 42" high Door, use 2 clips.
 - Installation Tip: Remove the door from the cabinet prior to installing the angle restriction clip. Insert the clip into the back of the cup hinge arm while it is in a 'closed' position.
- LSB Angle Restrictor Clip:**
 - BLUM Angle Restriction Clip for Lazy Susan 170-deg CLIP-ON Hinges
 - Reduces door LSB swing from 170-deg to 130-deg .
 - Easy to install, the LSB 170-deg angle restrictor clip snaps on to the projection point of the hinge.



BLUM-COMPACT RES CLIP



BLUM-LBS RES CLIP



STEM BUMPER

LOOSE SHELVES

ITEM	DESCRIPTION
VS-B09	Value Shelf B09
VS-B12	Value Shelf for B12
VS-B15	Value Shelf for B15

Loose Parts

LOOSE SHELVES CONT.

ITEM	DESCRIPTION
VS-B18	Value Shelf for B18
VS-B21	Value Shelf for B21
VS-B24	Value Shelf for B24
VS-B27	Value Shelf for B27
VS-B30	Value Shelf for B30
VS-B33	Value Shelf for B33
VS-B36	Value Shelf for B36
VS-B39	Value Shelf for B39
VS-B42	Value Shelf for B42
VS-BRA24	Value Shelf for BRA-24
VS-BT12	Value Shelf for BT12
VS-LSB33	Value Shelf for Lazy Susan Base 33
VS-LSB36	Value Shelf for Lazy Susan Base 36
VS-W09	Value Shelf for W09
VS-W12	Value Shelf for W12
VS-W15	Value Shelf for W15
VS-W1524D	Value Shelf for W15 24" Deep
VS-W18	Value Shelf for W18
VS-W21	Value Shelf for W21
VS-W24	Value Shelf for W24
VS-W2424D	Value Shelf for W24 24" Deep
VS-W27	Value Shelf for W27
VS-W30	Value Shelf for W30
VS-W3024D	Value Shelf for W3024 Deep
VS-W33	Value Shelf for W33
VS-W3324D	Value Shelf for W3324 Deep
VS-W36	Value Shelf for W36
VS-W3624D	Value Shelf for W3624 Deep
VS-W39	Value Shelf for W39
VS-W42	Value Shelf for W42
VS-WAE12	Value Shelf for WAE12
VS-WDC24	Value Shelf for WDC24
VS-WDC27	Value Shelf for WDC27

Height Alignment Guide

84" Height Alignment

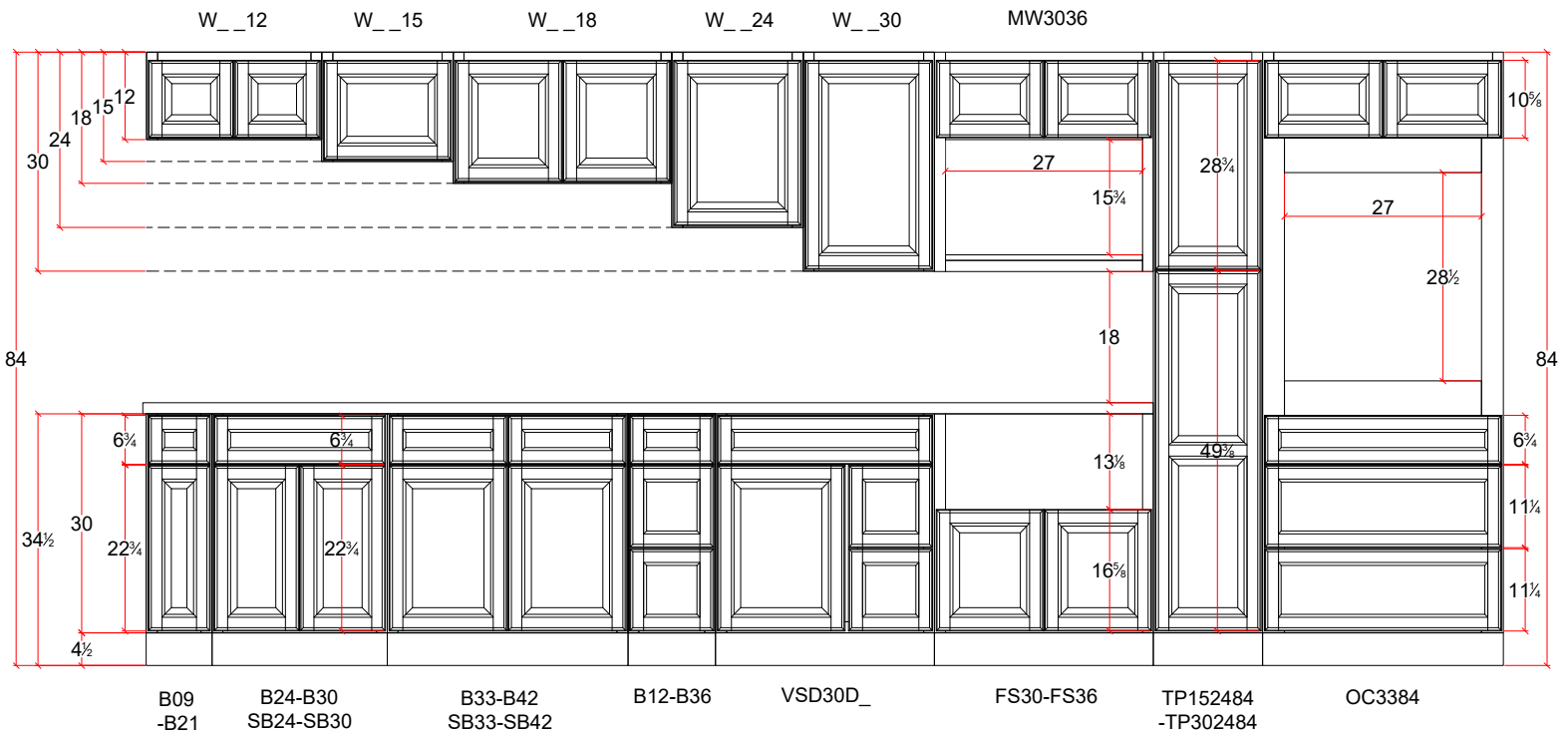

90" Height Alignment

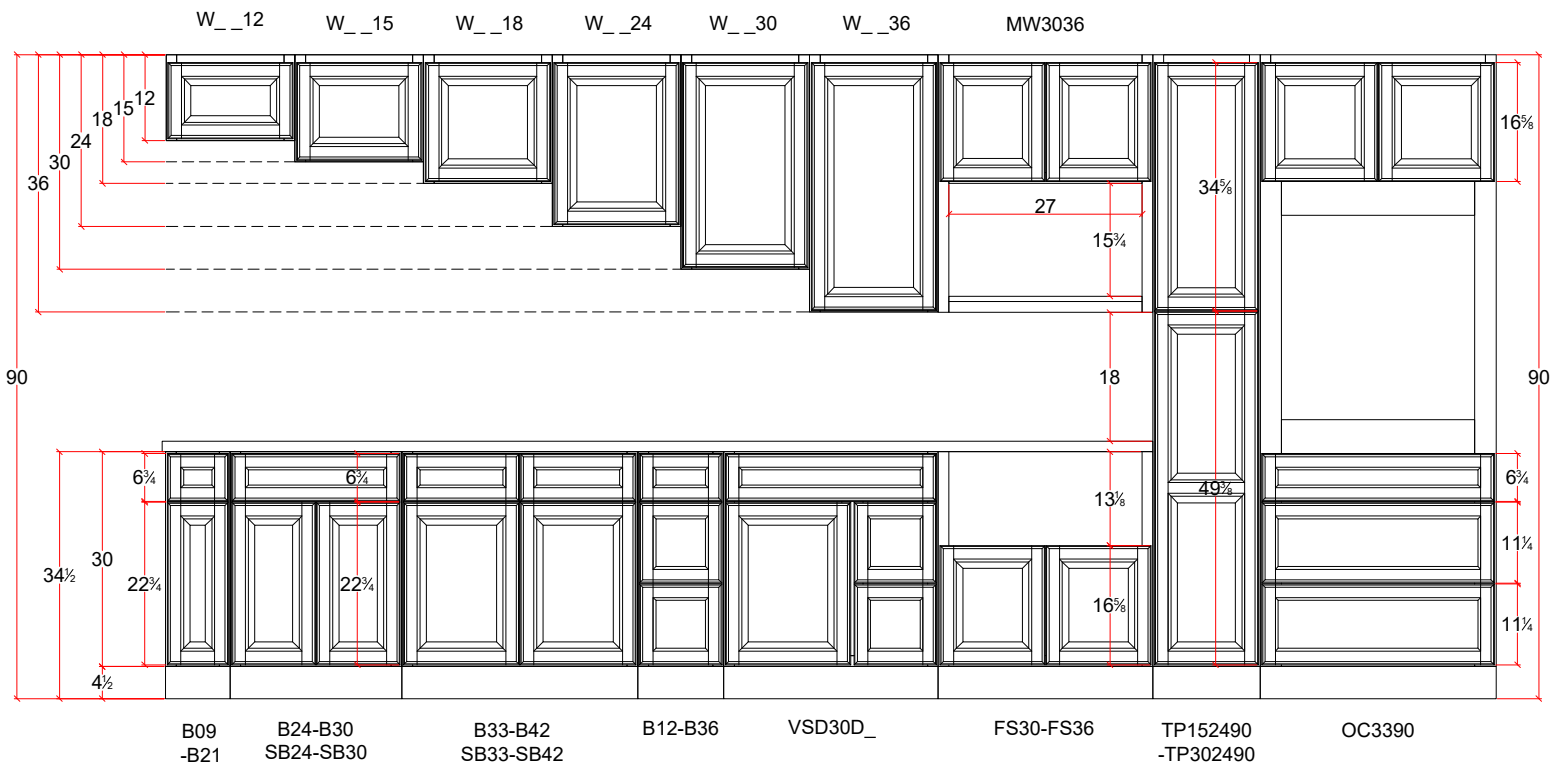

96" Height Alignment

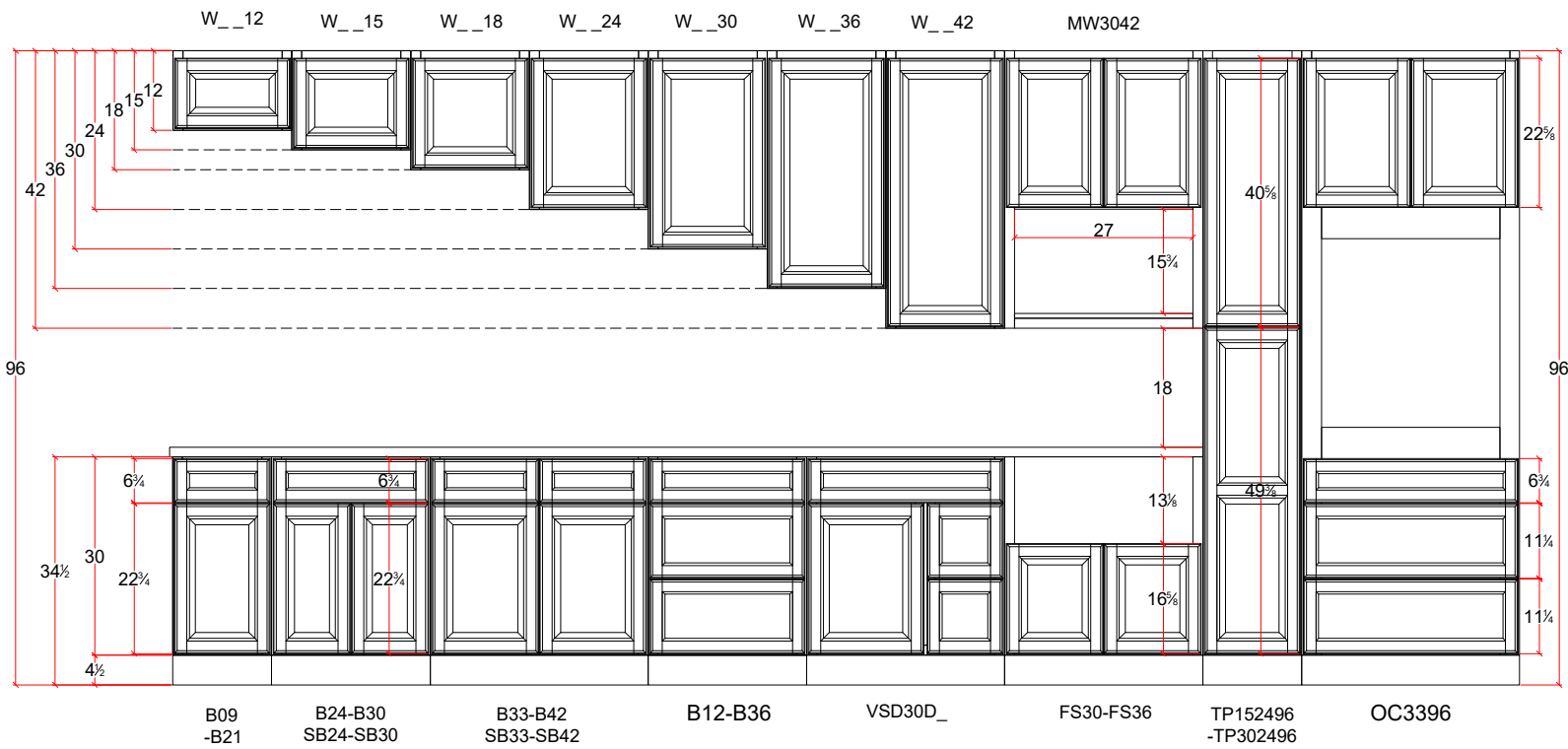

Notes

Copyright © 2024 by Fabuwood Cabinetry Corp.

All rights reserved.

No part of this publication may be reproduced, distributed, or transmitted in any form or by any means, including photocopying, scanning, or other electronic or mechanical methods, including online sharing, without the prior written permission of Fabuwood Cabinetry Corp.

