

 AVI\_8

For more details on operating this timepiece please refer to the enclosed booklet or visit:

**AVI-8.COM**



AVI-8

**SPITFIRE**

**TYPE 300 AUTOMATIC**

For more information  
Pour plus d'informations  
Para más información  
Per maggiori informazioni  
Für mehr Informationen  
想要查询更多资讯  
詳細については



**Instruction Manual**

Vol. 1.73A EN

**AV-4073**

# AUTOMATIC WATCH

This timepiece is equipped with a self-winding Mechanical Automatic movement.

**It does not need a battery.**

It is powered by the motions of the user's own wrist during the wear of the watch. You may also choose to wind the watch manually.

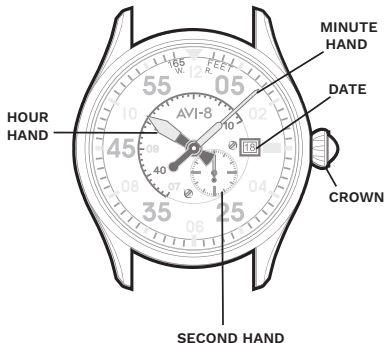

For more details on operating this timepiece please refer to the enclosed booklet or visit:

**AVI-8.COM**

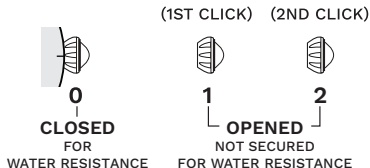

## **Before you use this watch, it is recommended that you manually wind the mainspring to start it moving.**

This watch is an automatic watch equipped with a manual winding mechanism.

### **WINDING THE MAINSPRING**

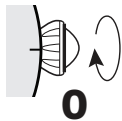

When it is in position [0], turn the crown clockwise to wind. Wind 5-10 times and it will start to move naturally after shaking slightly.

\* This watch **MUST** be worn for at least 8 (Eight) hours each day to ensure it is fully wound. An automatic watch will only wind when the watch is on your wrist and your arm moves. Winding the watch by the crown will put power on the spring but not enough to allow the watch to function fully. If your watch stops overnight or loses time it means it is not being fully wound.

## HOW TO SET THE TIME

1. Pull the crown out to position [2]-(2nd click).
2. Turn the crown clockwise to set the correct time.
3. Push the crown in.

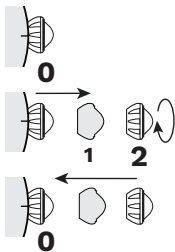

\* Take A.M./P.M. into consideration when setting the hour and minute hands to the desired time.

## HOW TO SET THE DATE

1. Pull the crown out to position [1]-(1st click).
2. Turn the crown anti-clockwise to set the correct date.
3. Push the crown in.

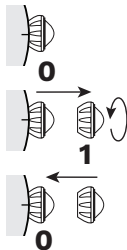

\* Do not set the date between 9:00 P.M. and 4:00 A.M.

# HOW TO CHANGE THE BRACELET TO LEATHER STRAP

1.

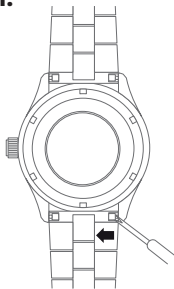

2.

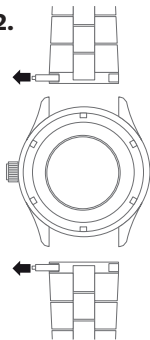

3.

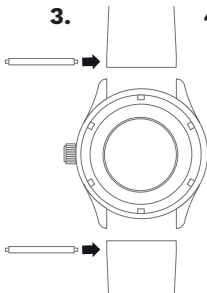

4.

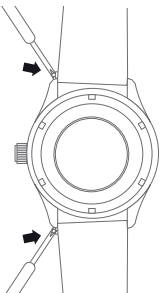

5.

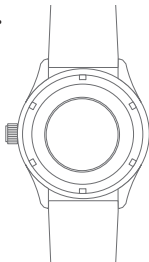

## HOW TO USE A DEPLOYANT CLASP

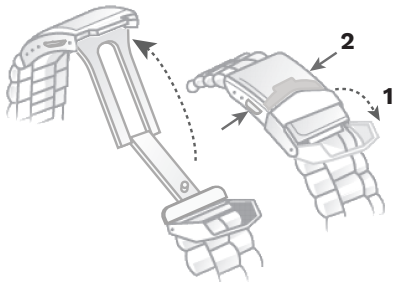

1. Flip the cover.

2. Press the buttons on the clasp sides.

## HOW TO RESIZE METAL BRACELET

On the inside of the bracelet, you will see some small arrows engraved on removeable links.

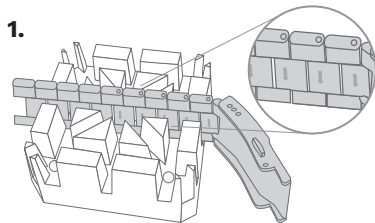

2.

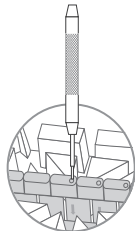

**3.**

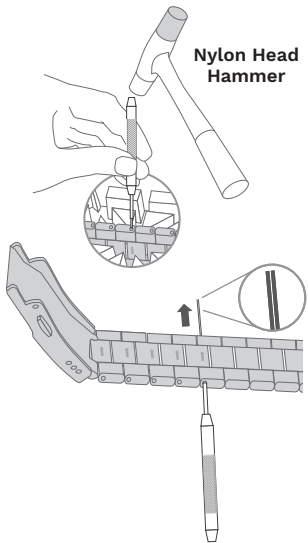

**5.**

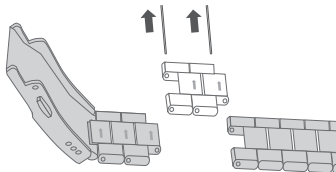

**6.**

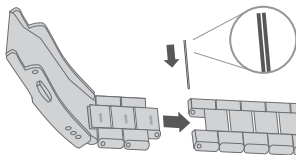

7.

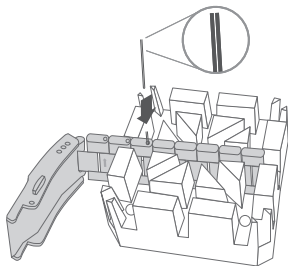

8.

**Nylon Head  
Hammer**

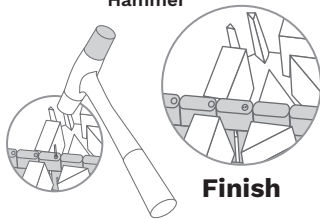

9.

**Micro size  
adjustment**

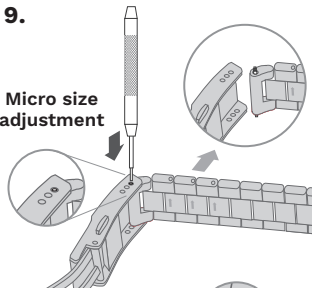

10.

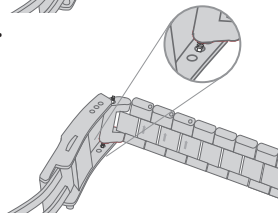



**11.**

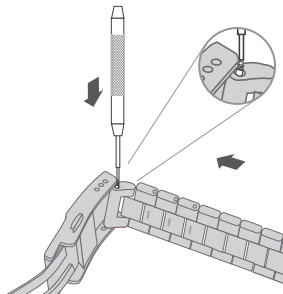

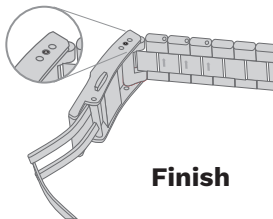

**12.**



## WATER RESISTANCE

Note that the water resistance chart serves only as a guide (please refer to the water resistance chart on the next page). Actual water resistance may vary depending on a number of factors including water temperature, water salinity and use under water. The water resistance of your timepiece may eventually be compromised over time with general wear and tear and use of your timepiece under adverse conditions.

Note that you should **NEVER** wear your watch in a jacuzzi, hot shower or steam room where steam may enter the case despite the watertight seals used to protect your watch. This may cause condensation inside your watch, which may affect and damage the inner workings of your watch.

<b>WATER RESISTANCE CHART</b>	<b>50M/ 5ATM</b>
<b>SPLASH/ SHOWERING</b>	
<b>SWIMMING/ BATHING</b>	
<b>BRIEF SWIMMING/ WATER SPORTS</b>	
<b>PROLONGED SWIMMING/ FREE DIVING</b>	
<b>SCUBA DIVING</b>	
<b>PROFESSIONAL DEEP SEA DIVING</b>	