

 AVI_8

For more details on operating this timepiece please refer to the enclosed booklet or visit:

AVI-8.COM



AVI-8

HAWKER
HURRICANE

CLASSIC CHRONOGRAPH

For more information
Pour plus d'informations
Para más información
Per maggiori informazioni
Für mehr Informationen
想要查询更多资讯
詳細については



Instruction Manual

Vol. 1.11 EN

AV-4011

CHRONOGRAPH WATCH

This watch is powered by a quartz Chronograph movement capable of split micro measurements of time.

With pinpoint accuracy you may use this watch to measure separate periods of elapsed time while simultaneously reading the current time.

For more details on operating this timepiece please refer to the enclosed booklet or visit:

AVI-8.COM

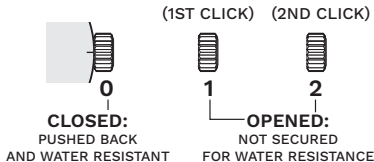
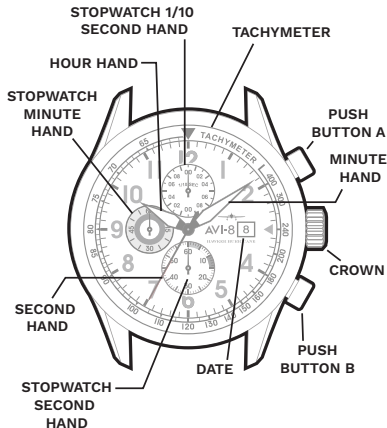

HOW TO SET THE DATE AND TIME

- * Before setting the time, check that the chronograph measurement is stopped.
1. Pull the crown out to position **[1]**-(1st click).
 2. Turn the crown clockwise until the previous day's date appears.
 3. Pull the crown out to position **[2]**-(2nd click).
When the second hand is at the 12 o'clock position. It will stop on the spot. Set the hands to the desired time of the day (make sure A.M./P.M. is set correctly) by turning the crown.
- * When the crown is at the position **[2]**-(2nd click), do not press any pusher. Otherwise the chronograph hands will move.
4. Push the crown back in the position **[0]** in accordance with a time signal.

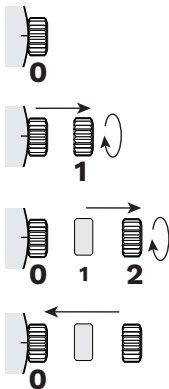

- * Do not set the date between 9:00 P.M. and 1:00 A.M., otherwise the date may not change properly. If it is necessary to set the date during the time period, first change the time to any time outside it, set the date and then reset the correct time.

STOPWATCH FUNCTION

- The measurement of time is indicated by the stopwatch hands that move independently of the center hands.
- The stopwatch can measure up to 60 minutes.
- The stopwatch measures in 1/10 second increments.

STANDARD MEASUREMENT

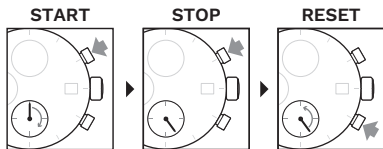

ACCUMULATED ELAPSED TIME MEASUREMENT

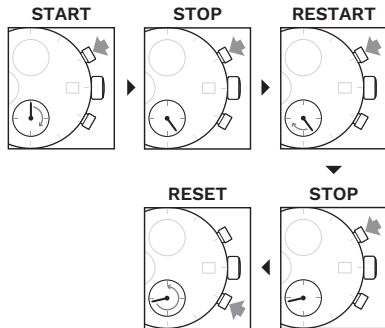

Restart and stop of the stopwatch can be repeated by pressing the button **A**.

SPLIT TIME MEASUREMENT

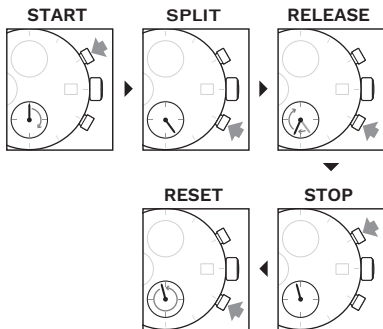

Measurement and release of split time can be repeated as many times as necessary by pressing the button **B**.

ADJUSTING STOPWATCH HANDS POSITION

- * Before setting the time, check if all the chronograph hands - 1/10 second (where applicable), second, minute - are at the "0" (12 o'clock) position.
- * If the stopwatch is in use, press the buttons in the following order to reset it, and then, check if the hands return to "0" position.
- * If the chronograph is counting : **A→B**
- * If the stopwatch is stopped : **B**
- * If the split time is displayed : **B→A→B**

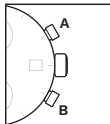

If either of the stopwatch hands are not in the "0" position, reset them following the procedure.

1. Pull the crown out to position [2]-(2nd click).
2. Press button **A** or **B** to reset all stopwatch hands to "0" position.
 - * The stopwatch minute hand moves correspondingly with the stopwatch second hand.
 - * The hands move quickly if the respective buttons are kept pressed.
3. Push the crown back to the normal position.

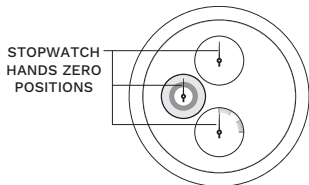
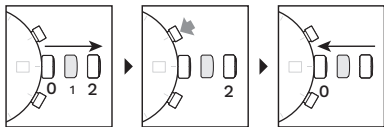

USING THE TACHYMETER

The most common use of a tachymeter is for measuring the approximate speed of a vehicle over a known distance.

(E.g.) Based on how many seconds it takes a vehicle to travel 1 km or 1 mile (the available measuring range is up to 60 seconds), the average speed within the distance can be calculated.

1. Start the chronograph when the vehicles commence travel.
2. After the vehicle has travelled 1 km/1 mile, stop the chronograph.

The approximate average speed within the distance can be determined by observing the present position of the stopwatch second hand and reading the outer bezel.

STOPWATCH SECOND HAND POINTS TO 9 O'CLOCK, THEREFORE THE TACHYMETER SCALE SHOULD BE READ AT 9 O'CLOCK. THE AVERAGE SPEED IS 80 KPH.

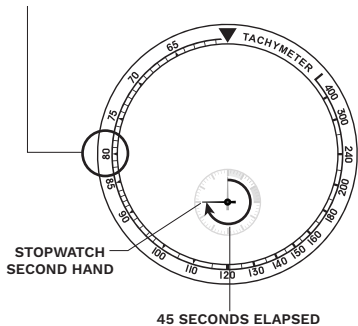

Note: The tachymeter indications may appear on dial ring, rather than on the outer bezel (depending on model).

As shown in the illustration, it takes the vehicle 45 seconds to travel 1 km so the approximate average speed is 80 kph (50 mph).

HOW TO USE A DEPLOYANT CLASP

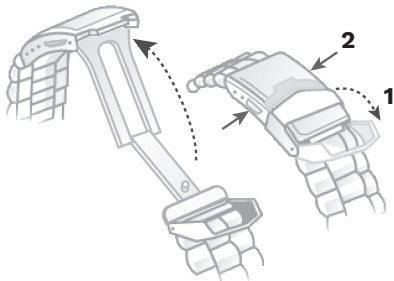

1. Flip the cover.
2. Press the buttons on the clasp sides.

HOW TO RESIZE METAL BRACELET

On the inside of the bracelet, you will see some small arrows engraved on removeable links.

1.

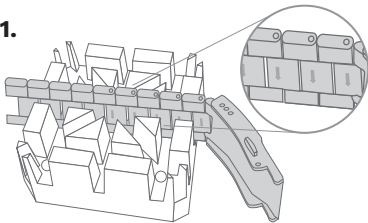

2.

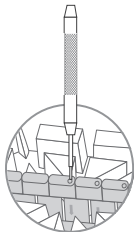

13

3.

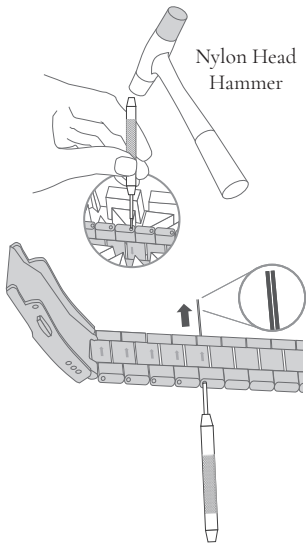

4.

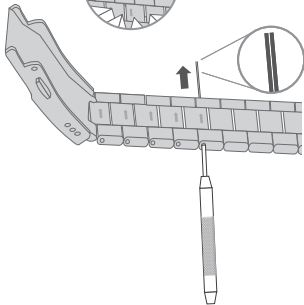

14

5.

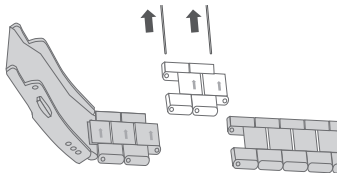

6.

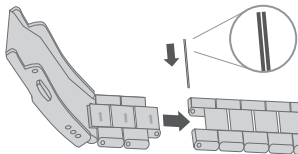

7.

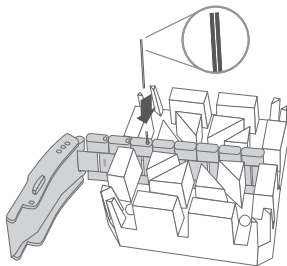

8.

Nylon Head
Hammer

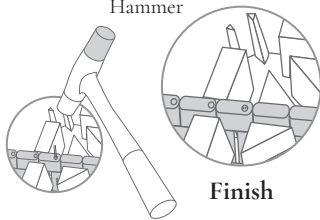

9.

Micro size
adjustment

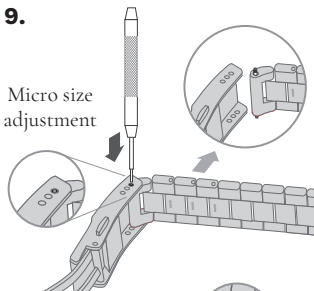

10.

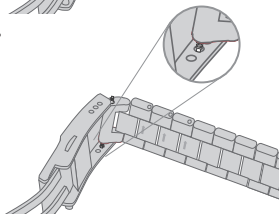

11.

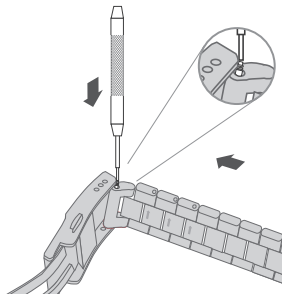

12.

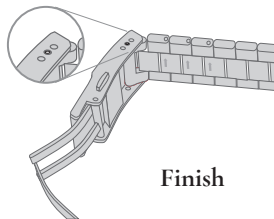





Finish

WATER RESISTANCE

Note that the water resistance chart serves only as a guide (please refer to the water resistance chart on the next page). Actual water resistance may vary depending on a number of factors including water temperature, water salinity and use under water. The water resistance of your timepiece may eventually be compromised over time with general wear and tear and use of your timepiece under adverse conditions.

Note that you should **NEVER** wear your watch in a jacuzzi, hot shower or steam room where steam may enter the case despite the watertight seals used to protect your watch. This may cause condensation inside your watch, which may affect and damage the inner workings of your watch.

WATER RESISTANCE CHART	50M/ 5ATM
SPLASH/ SHOWERING	
SWIMMING/ BATHING	
BRIEF SWIMMING/ WATER SPORTS	
PROLONGED SWIMMING/ FREE DIVING	
SCUBA DIVING	
PROFESSIONAL DEEP SEA DIVING	

Represented By:
Authorised Rep Compliance Ltd.,
Ground Floor, 71 Lower Baggot Street,
Dublin, D02 P593, Ireland.

WARNING

- **INGESTION HAZARD:** This product contains a button cell or coin battery.
- **DEATH** or serious injury can occur if ingested.
- A swallowed button cell or coin battery can cause **Internal Chemical Burns** in as little as **2 hours**.
- **KEEP** new and used batteries **OUT OF REACH** of **CHILDREN**.
- **Seek immediate medical attention** if a battery is suspected to be swallowed or inserted inside any part of the body.



**CE UK
CA**