

# Jack

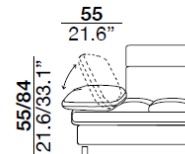
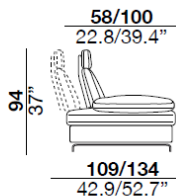
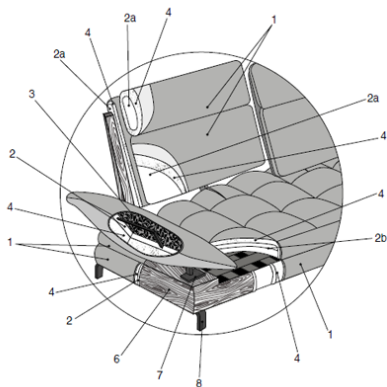

## materials

- 1\_cover
- 2\_frame upholstered with expanded polyurethane foam in different densities from 50 to 70 kg/m<sup>3</sup>; 2 types of foams
- 2a\_back cushions upholstery is in polyurethane foam with a density of 21 kg/m<sup>3</sup>
- 2b\_seat cushions upholstery is in polyurethane foam with in different densities from 18 to 40 kg/m<sup>3</sup>
- 3\_sterilized hypoallergenic goose-down
- 4\_acrylic padding
- 5\_elastic belts
- 6\_frame in multilayer poplar wood
- 7\_metal frame
- 8\_leg in polished chrome-plated metal or black chrome-plated metal

**this model is equipped with a mechanism that allows you to adjust the position of the backrest, increasing or reducing the seat depth. The armrest is also equipped with a mechanism that allows you to adjust its position**

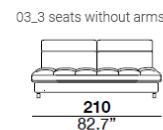
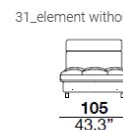
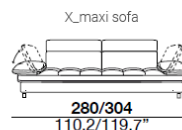
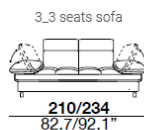

33\_long-chair without arms

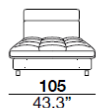

17\_long-chair left arm



18\_long-chair right arm

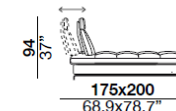
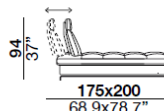
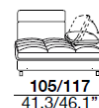

05\_1 seat left piece



06\_1 seat right piece



19\_3 seats left arm

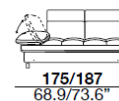

20\_3 seats right arm

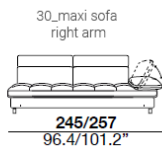
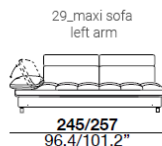
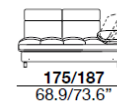

PQU\_square ottoman

