











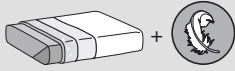

| | Seat - Assise | Backrests - Dossiers | Structure - Structure | |
|--|---|---|--|---|
| Upholstering <i>Revetement</i> (10) | Removable <i>Déhoussable</i> |   |   |  |
| | Not removable <i>Non déhoussable</i> | — | — |  |
| Padding <i>Rembourrages</i> (3-4-5-6-7-8-9) |  D.35/40kg/m³ |  D.21kg/m³ |  Tecnoform |  optional |

TECHNICAL INFORMATION

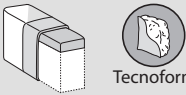
Structure: 1

Structure in solid wood panels, plywood, laminated solid FIR bearing various thicknesses supported by shaped steel frame.

Springing: 1-2

The back is made of multilayered wood or class E1 wood particleboard panels. The seat is supported by propylene and latex elastic belts.

INFORMATIONS TECHNIQUES

Structure: 1

Structure porteuse en panneau de bois contreplaqué latté et partie massives en sapin de différentes épaisseur, supporté par un encadrement en acier façonné.

Suspension: 1-2

Dossier en panneaux de bois multiplis ou particules de bois en classe E1. Assise avec sangles élastiques de fibre propylénique et latex.

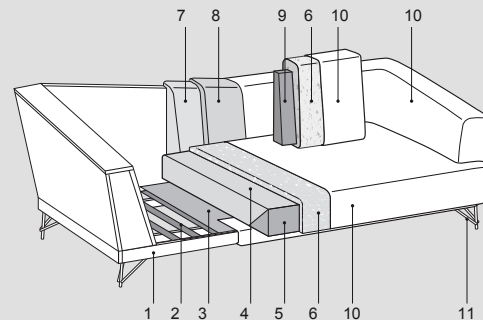
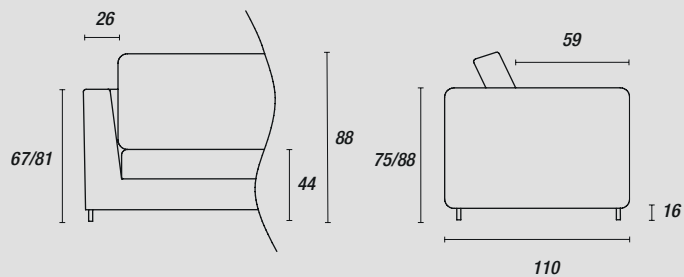

Feet - Pieds::

standard Lennox



H.16cm
Black (ME09)



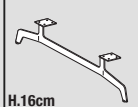







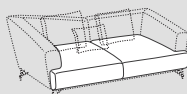

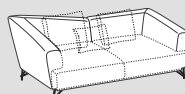



optional Sled

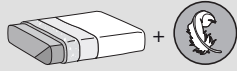

H.16cm
at a surcharge
Black (ME09)
Shining Chromium (ME04)

Lennox soft



| | | | | |
|---|---|--|---|---|
| |  Seat - Assise |  Cushions set - jeu de de coussins |  Structure - Structure | |
| Upholstering Revetement (10) | Removable Déhoussable   |   |  | |
| | Not removable Non déhoussable  |  |   | |
| Padding Rembourrages (3-4-5-6-7-8-9) |  D.35/40kg/m³ |  Mixed feather |  Tecnoform |  optional |

TECHNICAL INFORMATION

Structure: 1

Structure in solid wood panels, plywood, laminated solid FIR bearing various thicknesses supported by shaped steel frame.

Springing: 1-2

The back is made of multilayered wood or class E1 wood particleboard panels. The seat is supported by propylene and latex elastic belts.

INFORMATIONS TECHNIQUES

Structure: 1

Structure porteuse en panneau de bois contreplaqué latté et partie massives en sapin de différentes épaisseur, supporté par un encadrement en acier façonné.

Suspension: 1-2

Dossier en panneaux de bois multiplis ou particules de bois en classe E1. Assise avec sangles élastiques de fibre propylénique et latex.

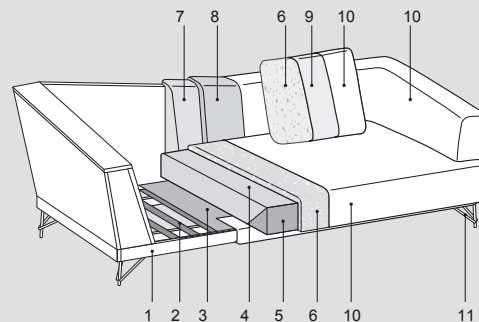
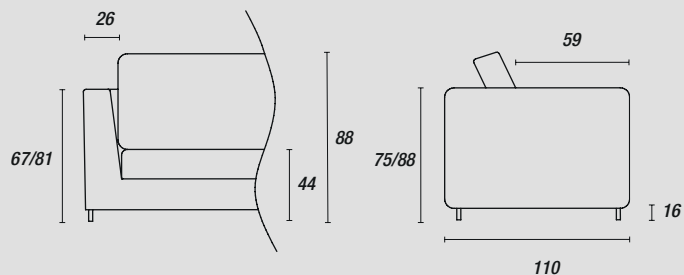

Feet - Pieds::

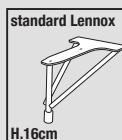

Black (ME09)

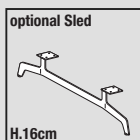

at a surcharge
Black (ME09)
Shining Chromium (ME04)