



simply design gianmaria e stefano conficconi 2017

Modular sofa with wooden and metal seat frame supported by elastic belts. The seat cushion is made of a double layer quilted cover with a core of polyurethane foam and is placed on a base of polyurethane foam. The adjustable back cushions and armrests have a metal frame padded with polyurethane foam. The loose lumbar cushions are filled with sterilized hypoallergenic goose-down. The legs are in dark brown painted or chromed metal.

Divano modulare con struttura sedile in legno e metallo, con supporto di nastri elastici. Il materassino di seduta è formato da un doppio strato di falda trapuntata con anima in poliuretano e poggia su uno strato di poliuretano espanso. Gli schienali e i braccioli reclinabili sono in metallo rivestiti in poliuretano espanso. I poggiatesta asportabili sono in piuma d'oca sterilizzata analergica. I piedi sono in metallo verniciato color moka o cromato lucido.

seat height

altezza seduta
43 cm
16.9"

seat depth

profondità seduta
55 cm
21.6"

arm width

larghezza braccio
18 cm
7.1"

arm height

altezza braccio
47 cm
30.3"

feet height

altezza piede
14 cm
5.5"

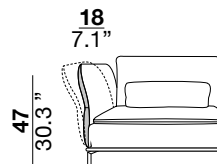
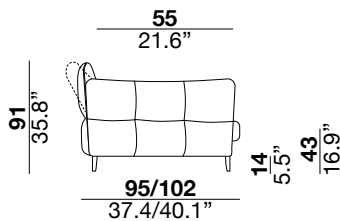

1

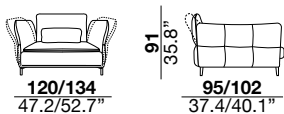

2



3



SX



01

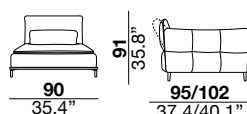

05/06

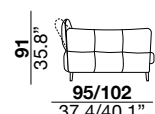
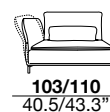

07/08

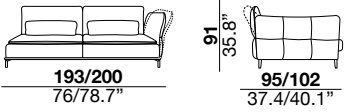
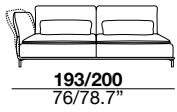

29/30

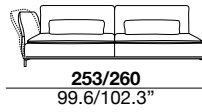

S09/S10

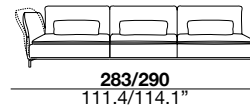

17/18

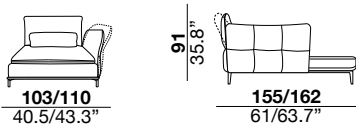
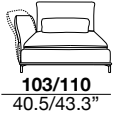

19/20

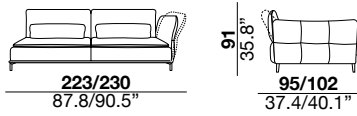
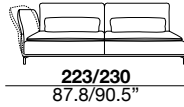

37/38

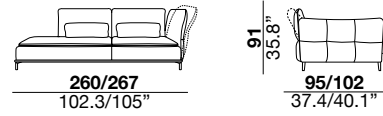
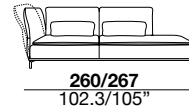

T11/T12

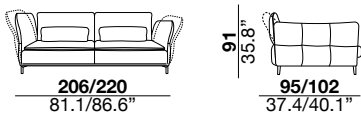
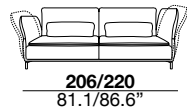

T13/T14

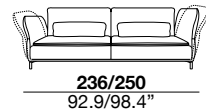

T21/T22

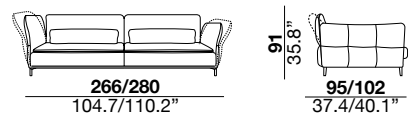
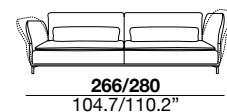

T23/T24

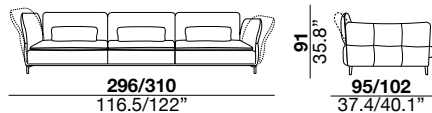
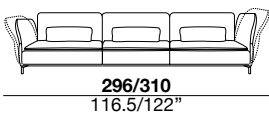

PRT

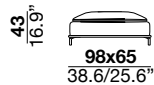

T23+08

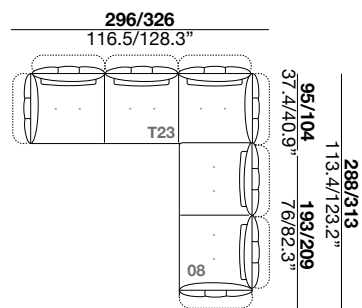

T11+08

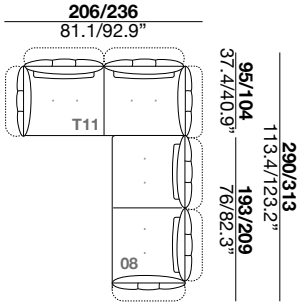

T13+20

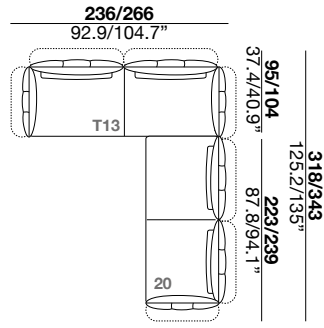

T21+30

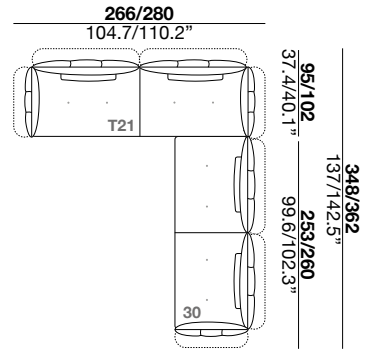

T23+S10

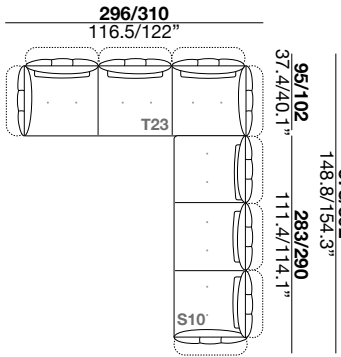

07+37

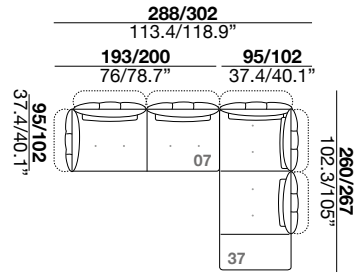

19+18

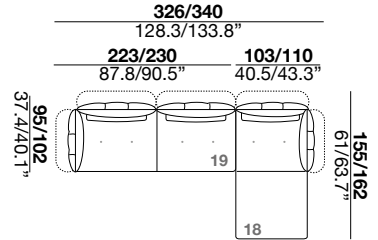

S09+37

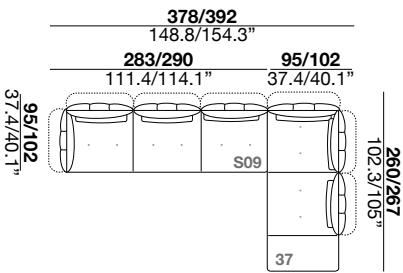

07+18

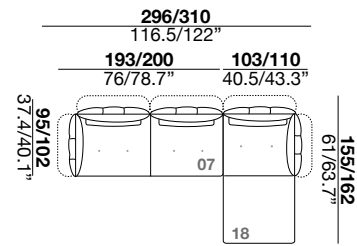



simply II design gianmaria e stefano conficconi 2017

Modular sofa with wooden and metal seat frame supported by elastic belts. The seat cushion is made of a double layer quilted cover with a core of polyurethane foam and is placed on a base of polyurethane foam. The adjustable back cushions and armrests have a metal frame padded with polyurethane foam. The loose lumbar cushions are filled with sterilized hypoallergenic goose-down. The legs are in dark brown painted or chromed metal.

Divano modulare con struttura sedile in legno e metallo, con supporto di nastri elastici. Il materassino di seduta è formato da un doppio strato di falda trapuntata con anima in poliuretano e poggia su uno strato di poliuretano espanso. Gli schienali e i braccioli reclinabili sono in metallo rivestiti in poliuretano espanso. I poggiatesta asportabili sono in piuma d'oca sterilizzata analergica. I piedi sono in metallo verniciato color moka o cromato lucido.

seat height

altezza seduta
43 cm
16.9"

seat depth

profondità seduta
46 cm
18.1"

arm width

larghezza braccio
18 cm
7.1"

arm height

altezza braccio
47 cm
30.3"

feet height

altezza piede
14 cm
5.5"

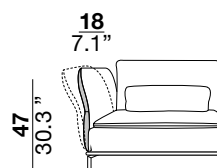
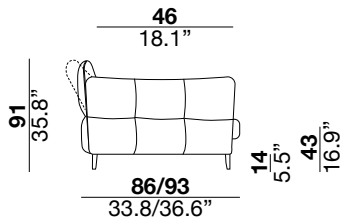

1

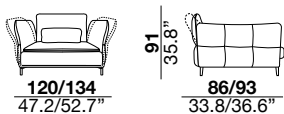

2



3



SX



01

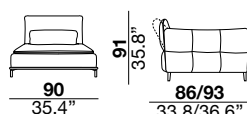

05/06

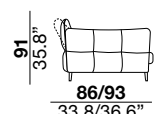
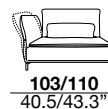

07/08

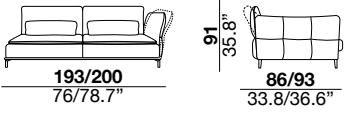
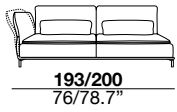

29/30

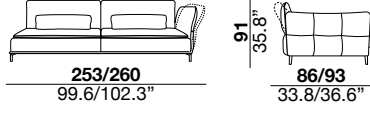
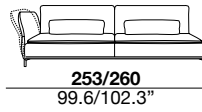

S09/S10

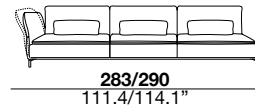

17/18

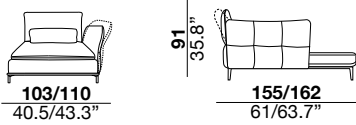
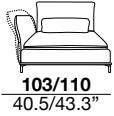

19/20

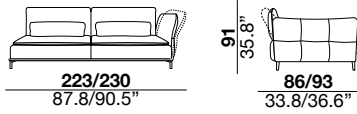
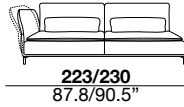

37/38

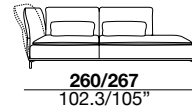

T11/T12

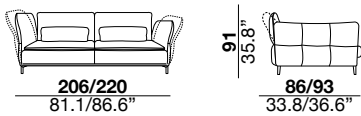
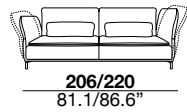

T13/T14

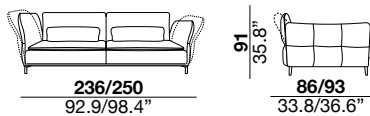
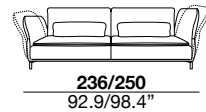

T21/T22

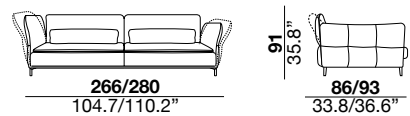
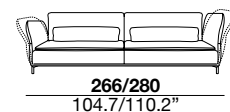

T23/T24

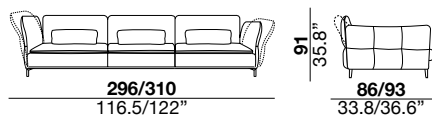
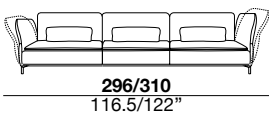

PRT

