



## dolce vita design stefano conficconi 2010

Modular sofa with a wooden frame supported by elastic belts. The seat cushions are filled with polyurethane foam covered with hypoallergenic goose-down. The back cushions are made of expanded polyurethane foam covered with feathers. Armrests are made of wood covered with expanded polyurethane foam and sterilised hypoallergenic goose-down. The base is made of polished chrome-plated metal available also in black chrome-plated metal.

Divano modulare con fusto in legno e supporto di nastri elastici. Le sedute hanno un inserto in poliuretano espanso rivestito con piuma d'oca sterilizzata anallergica. Gli schienali sono in piuma con un inserto di poliuretano espanso. Il bracciolo in legno è rivestito con poliuretano espanso e piuma d'oca sterilizzata anallergica. Basamento in metallo cromato lucido, disponibile anche cromato nero.

<b>seat height</b> altezza seduta 45 cm 17.7"	<b>seat depth</b> profondità seduta 67 cm 26.4"	<b>arm width</b> larghezza braccio 30 cm 11.8"	<b>arm height</b> altezza braccio 69 cm 27.2"	<b>feet height</b> altezza piede 6 cm 2.3"
--	--	---	--	---

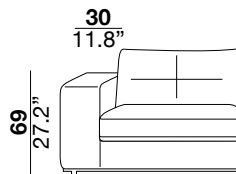
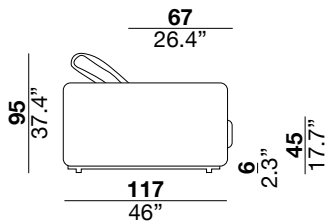

1PI armchair

3

X

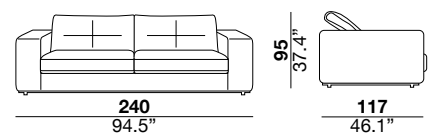
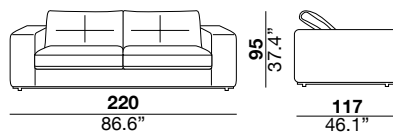
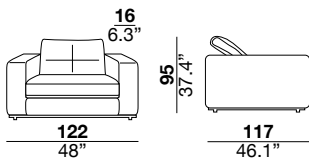

01L

31

01

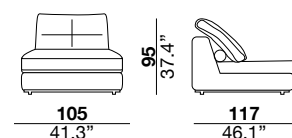
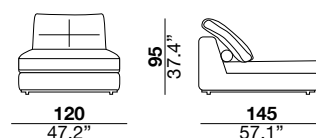
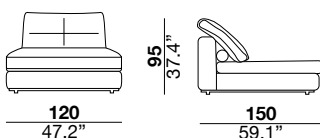

05/06

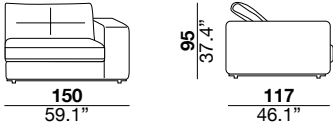
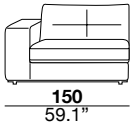

05P/06P

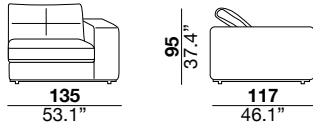
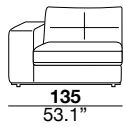

19/20

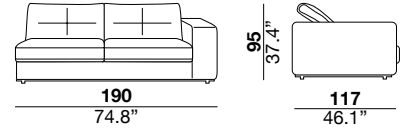
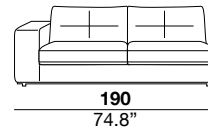

29/30

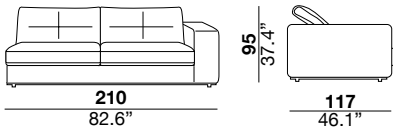
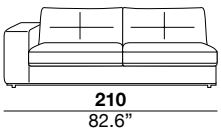

37/38

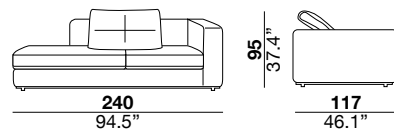
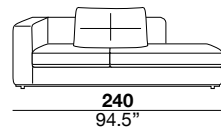

17/18

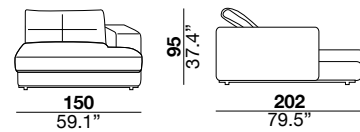
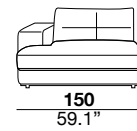

15/16

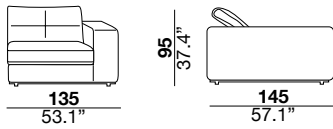
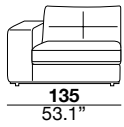

15G/16G

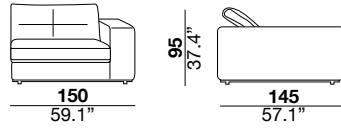
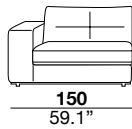

PQU

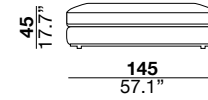

PQP

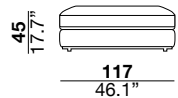

P01

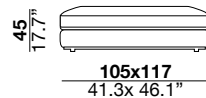

C75

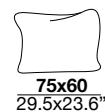

SKG

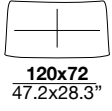

15G+16G

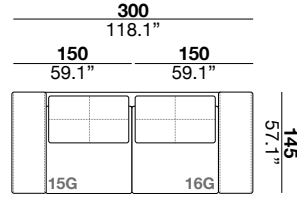

15G+18

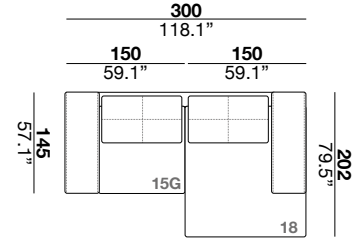

15+31+16

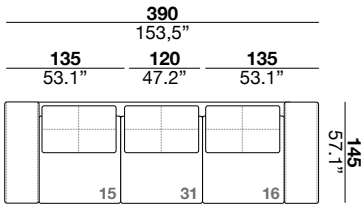

15G+31+37

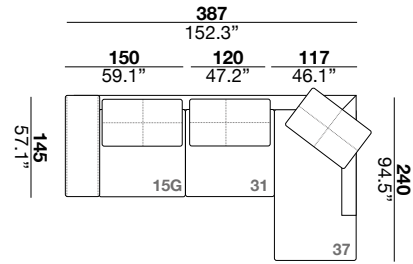

15+01+P01+37

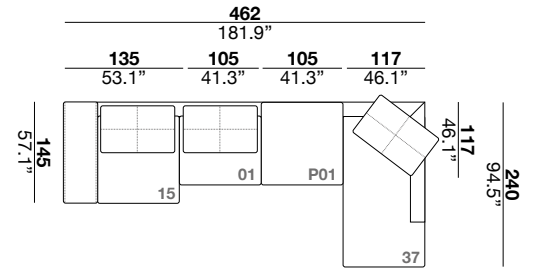



## dolceVita b design stefano conficconi 2010

Modular sofa with a wooden frame supported by elastic belts. The seat cushions are filled with polyurethane foam covered with hypoallergenic goose-down. The back cushions are made of expanded polyurethane foam covered with feathers. Armrests are made of wood covered with expanded polyurethane foam and sterilised hypoallergenic goose-down. The base is made of polished chrome-plated metal available also in black chrome-plated metal.

Divano modulare con fusto in legno e supporto di nastri elastici. Le sedute hanno un inserto in poliuretano espanso rivestito con piuma d'oca sterilizzata anallergica. Gli schienali sono in piuma con un inserto di poliuretano espanso. Il bracciolo in legno è rivestito con poliuretano espanso e piuma d'oca sterilizzata anallergica. Basamento in metallo cromato lucido, disponibile anche cromato nero.

<b>seat height</b> altezza seduta 45 cm 17.7"	<b>seat depth</b> profondità seduta 67 cm 26.4"	<b>arm width</b> larghezza braccio 16 cm 6.3"	<b>arm height</b> altezza braccio 69 cm 27.2"	<b>feet height</b> altezza piede 6 cm 2.3"
--	--	--	--	---

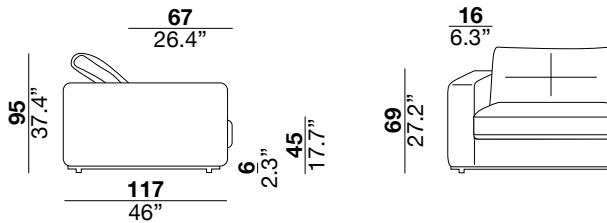

1PI armchair

3

X

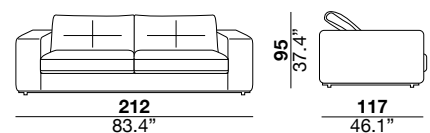
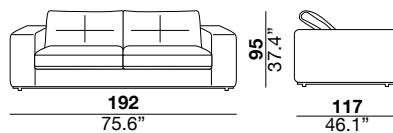
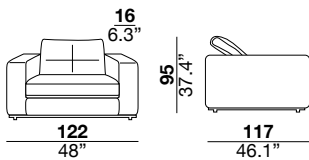

01L

31

01

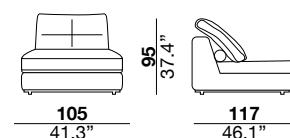
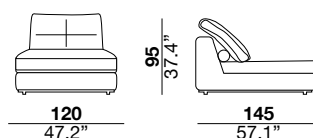
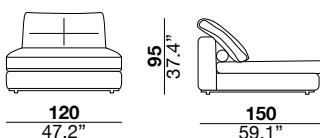

05/06

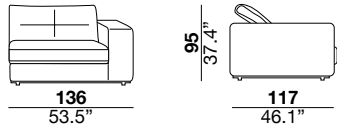
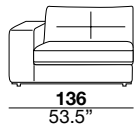

05P/06P

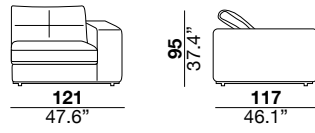
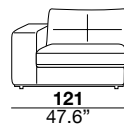

19/20

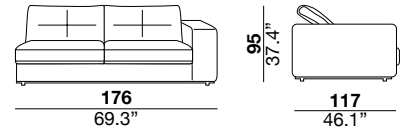
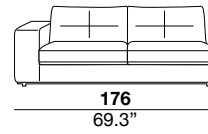

29/30

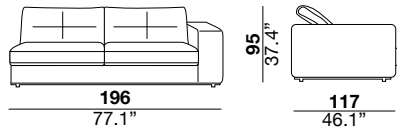
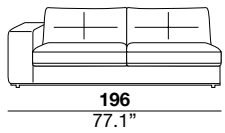

37/38

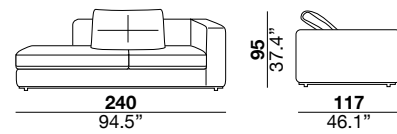
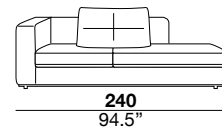

17/18

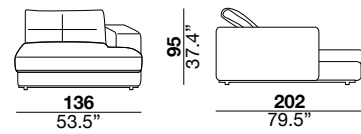
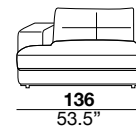

15/16

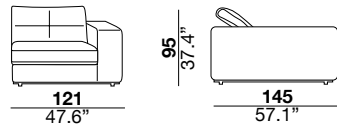
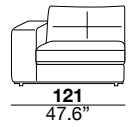

15G/16G

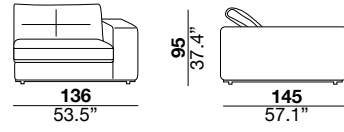
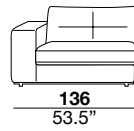

PQU

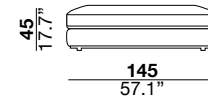

PQP

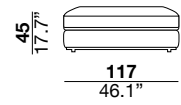

P01

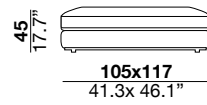

C75



SKG

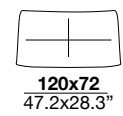



## dolcevita d design stefano conficconi 2010

Modular sofa with a wooden frame supported by elastic belts. The seat cushions are filled with polyurethane foam covered with hypoallergenic goose-down. The back cushions are made of expanded polyurethane foam covered with feathers. Armrests are made of wood covered with expanded polyurethane foam and sterilised hypoallergenic goose-down. The base is made of polished chrome-plated metal available also in black chrome-plated metal.

Divano modulare con fusto in legno e supporto di nastri elastici. Le sedute hanno un inserto in poliuretano espanso rivestito con piuma d'oca sterilizzata anallergica. Gli schienali sono in piuma con un inserto di poliuretano espanso. Il bracciolo in legno è rivestito con poliuretano espanso e piuma d'oca sterilizzata anallergica. Basamento in metallo cromato lucido, disponibile anche cromato nero.

<b>seat height</b> altezza seduta 45 cm 17.7"	<b>seat depth</b> profondità seduta 67 cm 26.4"	<b>arm width</b> larghezza braccio 24 cm 9.4"	<b>arm height</b> altezza braccio 69 cm 27.2"	<b>feet height</b> altezza piede 6 cm 2.3"
--	--	--	--	---

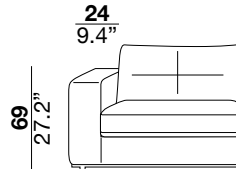
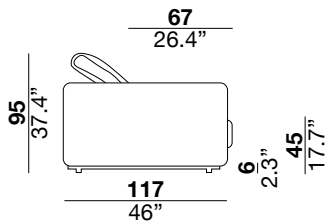

1PI armchair

3

X

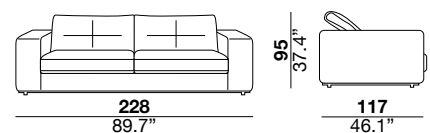
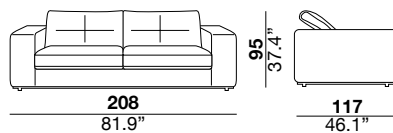
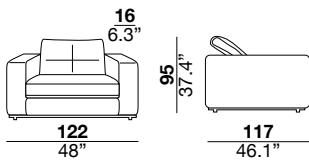

01L

31

01

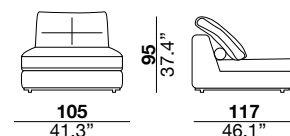
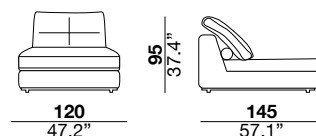
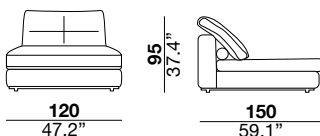

05/06

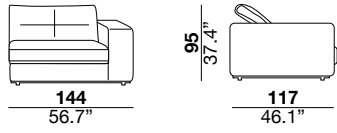
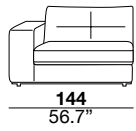

05P/06P

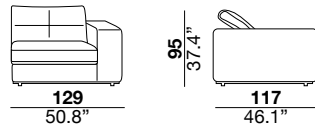
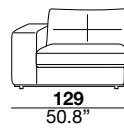

19/20

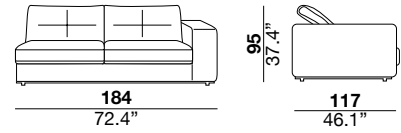
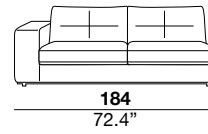

29/30

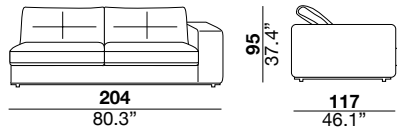
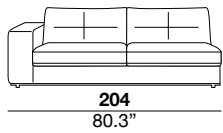

37/38

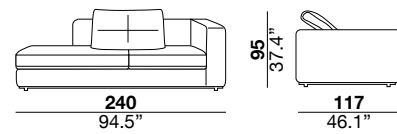
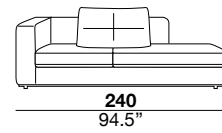

17/18

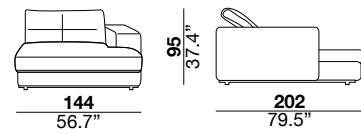
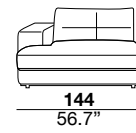

15/16

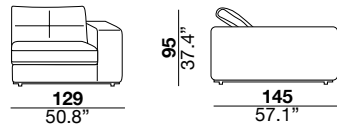
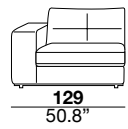

15G/16G

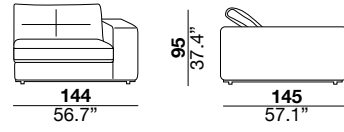
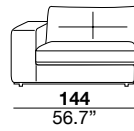

PQU

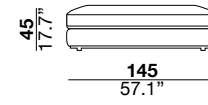

PQP

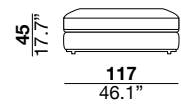

P01

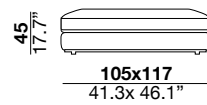

C75



SKG

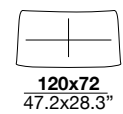



## dolcevita small design stefano conficconi 2010

Modular sofa with a wooden frame supported by elastic belts. The seat cushions are filled with polyurethane foam covered with hypoallergenic goose-down. The back cushions are made of expanded polyurethane foam covered with feathers. Armrests are made of wood covered with expanded polyurethane foam and sterilised hypoallergenic goose-down. The base is made of polished chrome-plated metal available also in black chrome-plated metal.

Divano modulare con fusto in legno e supporto di nastri elastici. Le sedute hanno un inserto in poliuretano espanso rivestito con piuma d'oca sterilizzata anallergica. Gli schienali sono in piuma con un inserto di poliuretano espanso. Il bracciolo in legno è rivestito con poliuretano espanso e piuma d'oca sterilizzata anallergica. Basamento in metallo cromato lucido, disponibile anche cromato nero.

<b>seat height</b> altezza seduta 45 cm 17.7"	<b>seat depth</b> profondità seduta 67 cm 26.4"	<b>arm width</b> larghezza braccio 30 cm 11.8"	<b>arm height</b> altezza braccio 69 cm 27.2"	<b>feet height</b> altezza piede 6 cm 2.3"
--	--	---	--	---

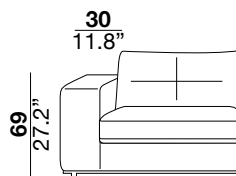
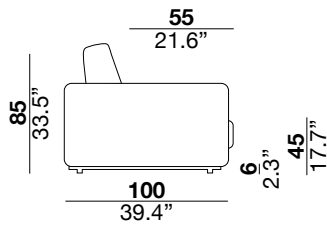

3

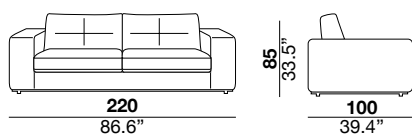

3

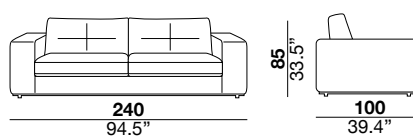

X

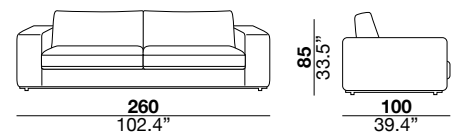

07/08

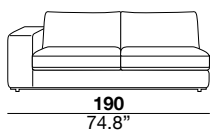

19/20

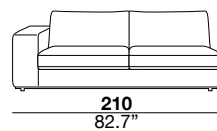

29/30

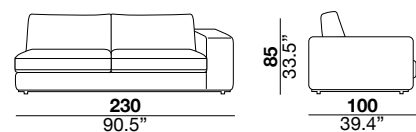
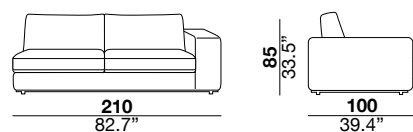
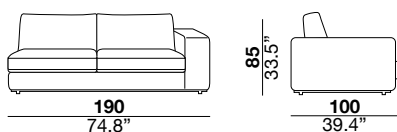
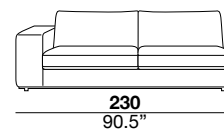



37/38

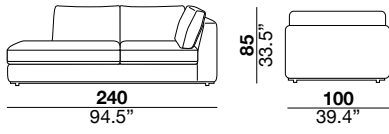
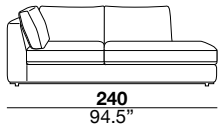

17/18

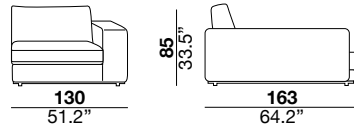
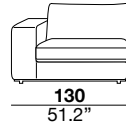

15/16

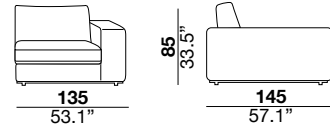
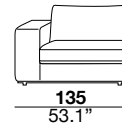

15G/16G

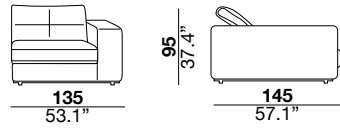
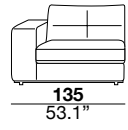

PRT

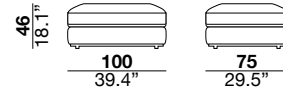

PQU

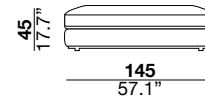

RPT

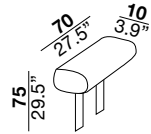

C75



19+18

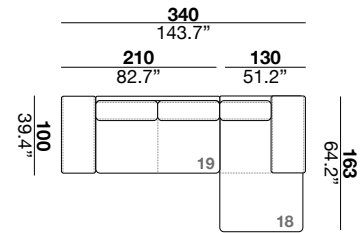

29+18

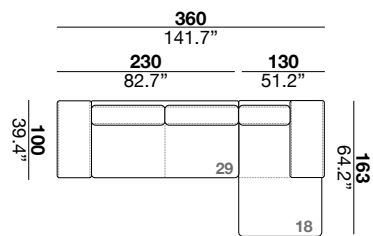

29+37

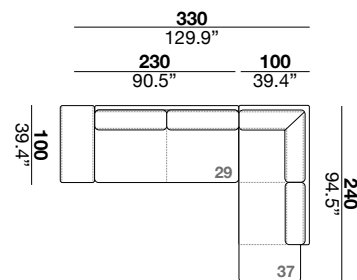

29+18

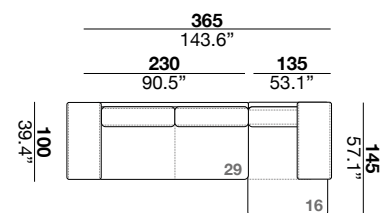



## dolcevita small b design stefano conficconi 2010

Modular sofa with a wooden frame supported by elastic belts. The seat cushions are filled with polyurethane foam covered with hypoallergenic goose-down. The back cushions are made of expanded polyurethane foam covered with feathers. Armrests are made of wood covered with expanded polyurethane foam and sterilised hypoallergenic goose-down. The base is made of polished chrome-plated metal available also in black chrome-plated metal.

Divano modulare con fusto in legno e supporto di nastri elastici. Le sedute hanno un inserto in poliuretano espanso rivestito con piuma d'oca sterilizzata anallergica. Gli schienali sono in piuma con un inserto di poliuretano espanso. Il bracciolo in legno è rivestito con poliuretano espanso e piuma d'oca sterilizzata anallergica. Basamento in metallo cromato lucido, disponibile anche cromato nero.

<b>seat height</b> altezza seduta 45 cm 17.7"	<b>seat depth</b> profondità seduta 67 cm 26.4"	<b>arm width</b> larghezza braccio 16 cm 6.3"	<b>arm height</b> altezza braccio 69 cm 27.2"	<b>feet height</b> altezza piede 6 cm 2.3"
--	--	--	--	---

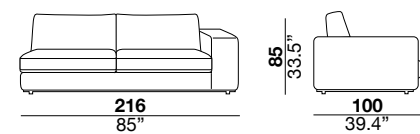
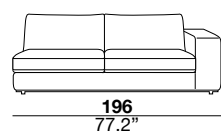
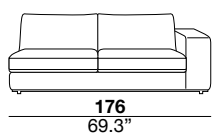
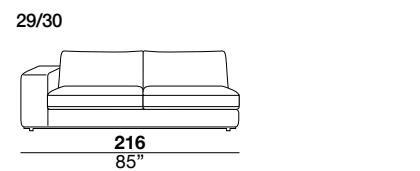
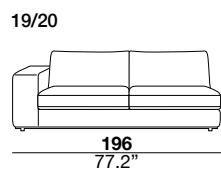
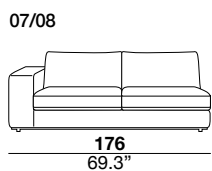
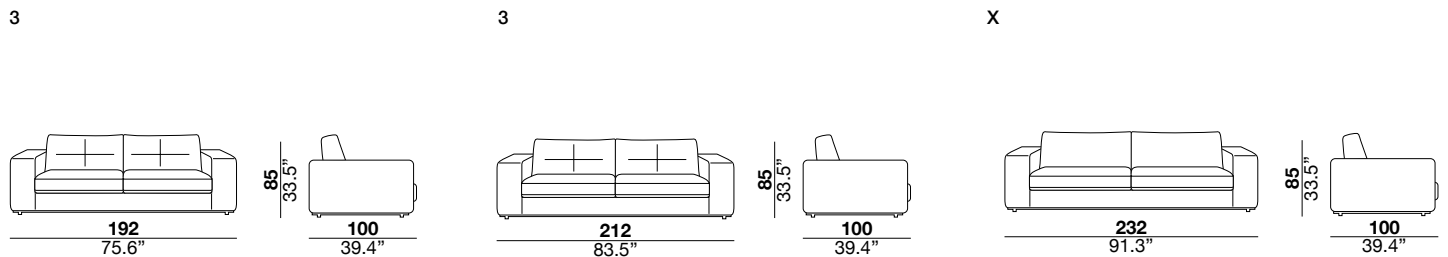
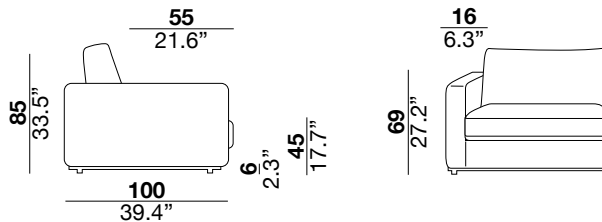

37/38

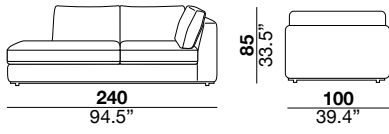
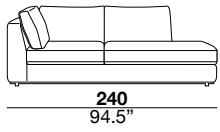

17/18

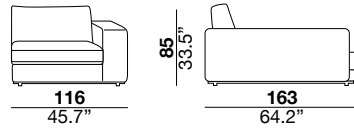
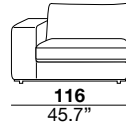

15/16

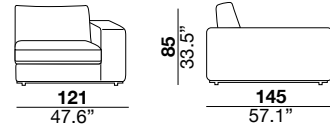
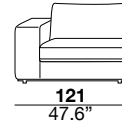

15G/16G

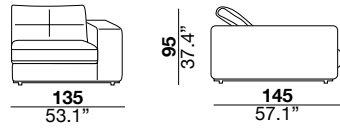
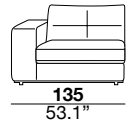

PRT

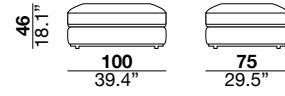

PQU

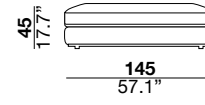

RPT

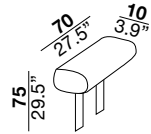

C75





## dolcevita small d design stefano conficconi 2010

Modular sofa with a wooden frame supported by elastic belts. The seat cushions are filled with polyurethane foam covered with hypoallergenic goose-down. The back cushions are made of expanded polyurethane foam covered with feathers. Armrests are made of wood covered with expanded polyurethane foam and sterilised hypoallergenic goose-down. The base is made of polished chrome-plated metal available also in black chrome-plated metal.

Divano modulare con fusto in legno e supporto di nastri elastici. Le sedute hanno un inserto in poliuretano espanso rivestito con piuma d'oca sterilizzata anallergica. Gli schienali sono in piuma con un inserto di poliuretano espanso. Il bracciolo in legno è rivestito con poliuretano espanso e piuma d'oca sterilizzata anallergica. Basamento in metallo cromato lucido, disponibile anche cromato nero.

<b>seat height</b> altezza seduta 45 cm 17.7"	<b>seat depth</b> profondità seduta 67 cm 26.4"	<b>arm width</b> larghezza braccio 24 cm 9.4"	<b>arm height</b> altezza braccio 69 cm 27.2"	<b>feet height</b> altezza piede 6 cm 2.3"
--	--	--	--	---

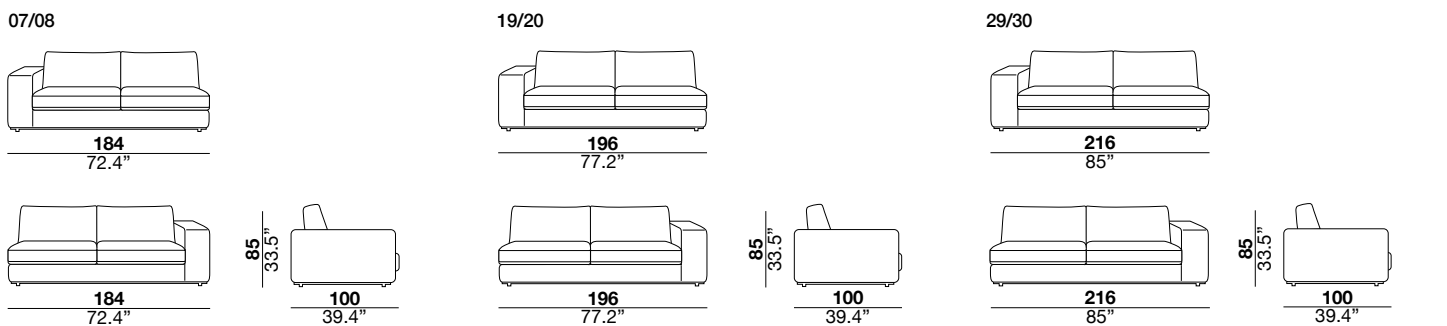
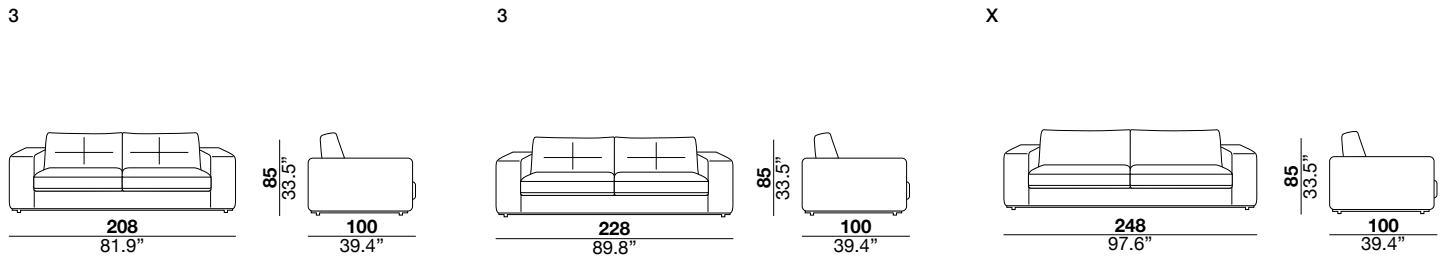
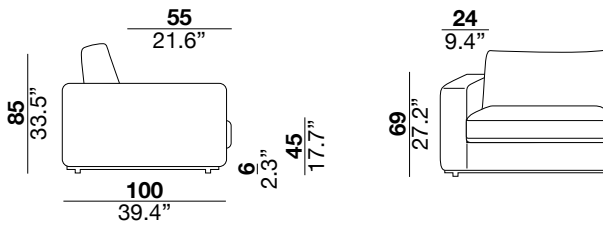

37/38

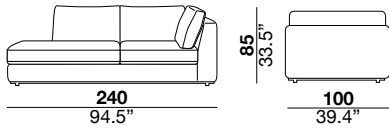
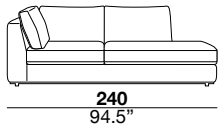

17/18

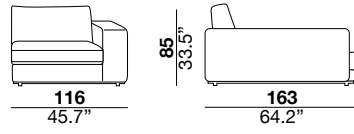
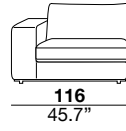

15/16

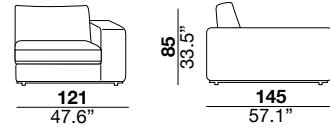
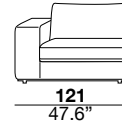

15G/16G

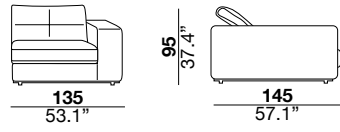
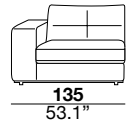

PRT

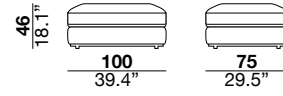

PQU

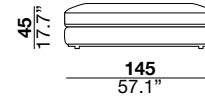

RPT

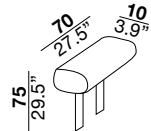

C75

