

make it real!
Bringing Creativity to Life™

INSTRUCTIONS • INSTRUKTIONER •
INSTRUKTIONER • INSTRUKSJONER



Go to • Gå ind på
Besök • Gå inn på
makeitrealplay.com
for video instructions!
for at se videoinstruktioner!
ör videoinstruktioner!
or å se videoinstruksjoner!

WHAT'S INSIDE • INDHOLD • INNEHÅLL • INNHOLD:

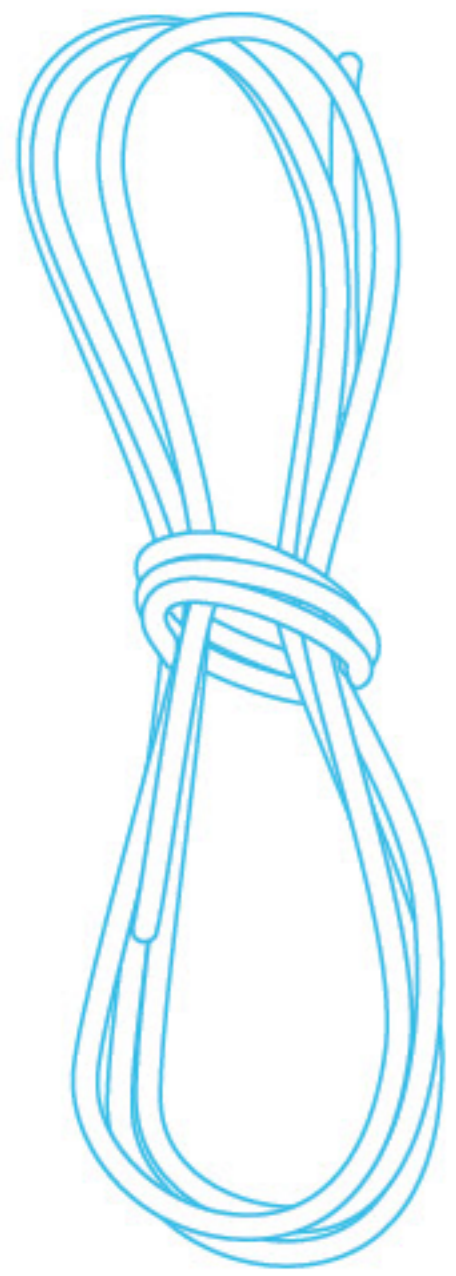

 ×32

 ×14

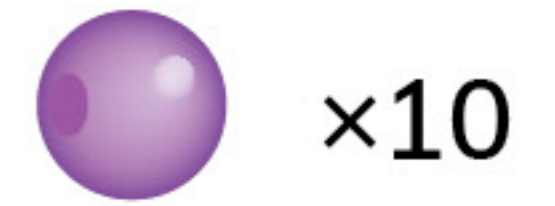
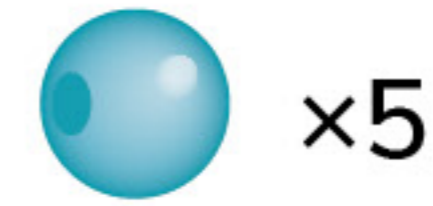
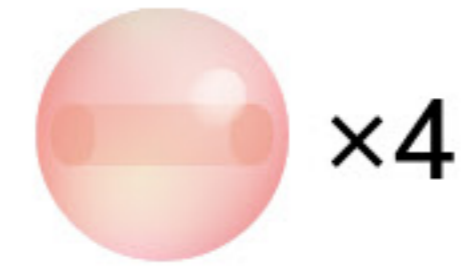
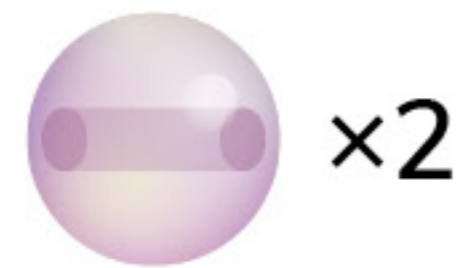
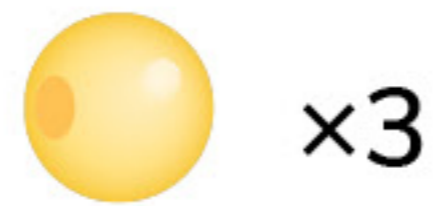
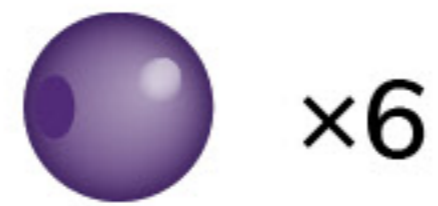
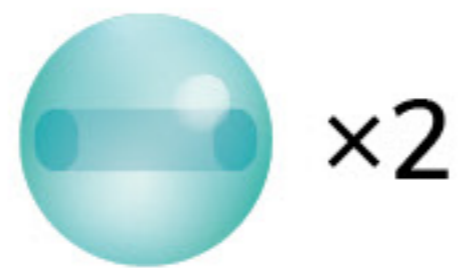

Not included • Ikke inkluderet •
Ingår ej • Ikke inkludert



LEGEND • SYMBOLER • SYMBOLER • SYMBOLER



Scissor • Saks
Sax • Saks



Ruler • Målebånd
Måttband • Målebånd



Adhesive tape • Tape
Tejp • Teip



Pliers • Smykkesang
Tång • Tang



Craft glue • Hobbylim
Hobbylim • Hobbylim



Let dry • Lad den tørre
Låt torka • La tørke



Double knot • Dobbeltnude
Dubbelknut • Dobbeltnute



Repeat • Gentag
Upprepa • Gjenta



Clear nail polish • Klar neglelak
Klart nagellack • Klar neglelakk



READ THE INSTRUCTIONS ALL THE WAY TO THE END BEFORE STARTING YOUR PROJECT.
 LÆS INSTRUKTIONERNE GRUNDIGT INDEN DU BEGYNDER PÅ DIT PROJEKT.
 LÄS IGENOM INSTRUKTIONERNA NOGGRANT INNAN DU PÅBÖRJAR DITT PROJEKT.
 LES INSTRUKSJONENE NØYE FØR DU BEGYNNER PÅ PROSJEKTET.

- EN Install the PlayTray by taping it to a flat surface as shown. Ask an adult for permission before taping the surface.
- DK Tape bakken fast på en plan overflade, som vist på billedet. Spørg en voksen om lov inden du taper den fast.
- SE Tejpa fast brickan på en plan yta som på bilden. Fråga en vuxen innan du tejpar.
- NO Teip boksen fast på et flat overflate, som vist på bildet. Spør en voksen om lov før du teiper den fast.

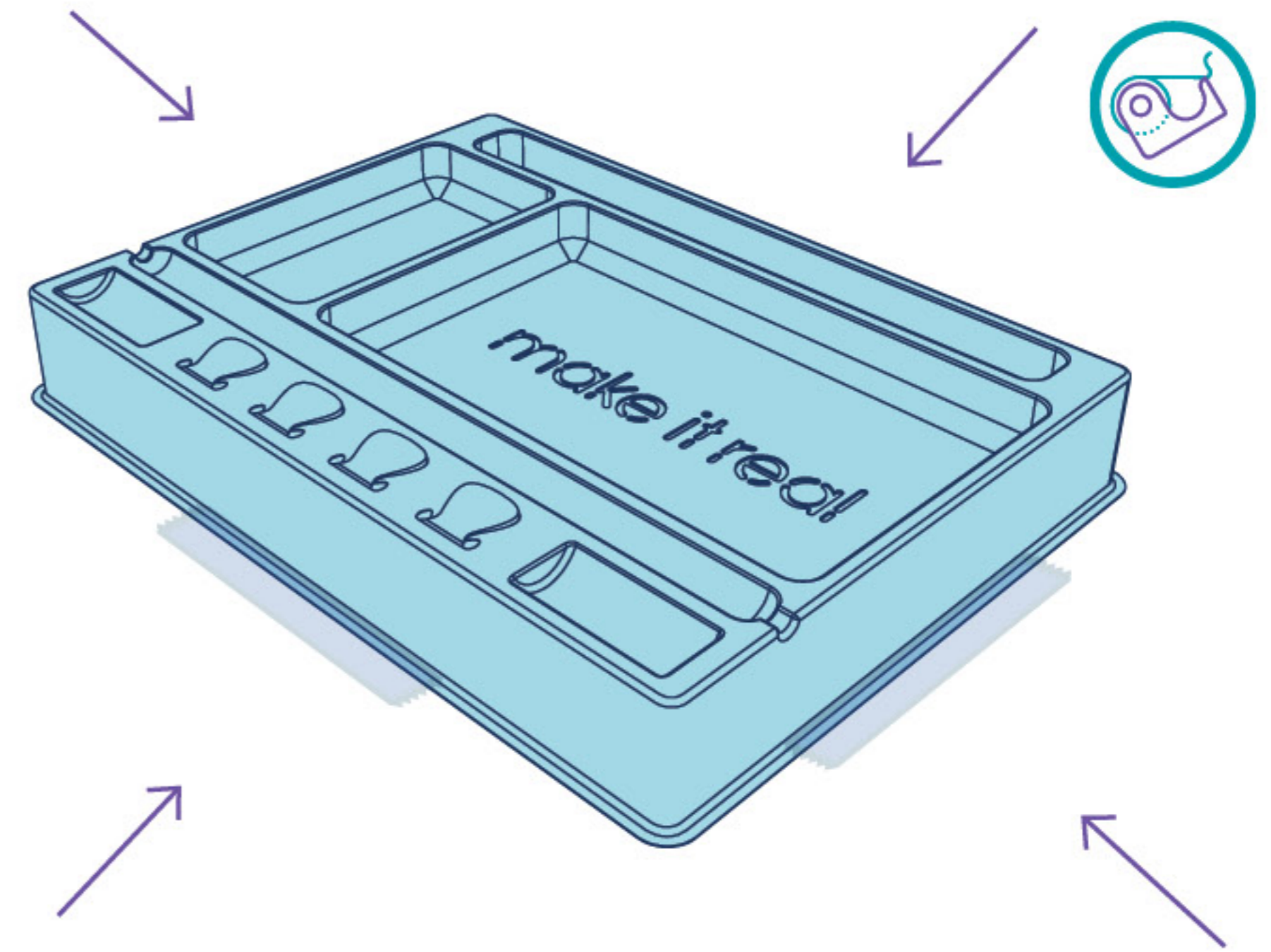

- EN (Optional) Place your phone in the media slot and follow the instructions on the Make It Real app.
- DK (Valgfrit) Placer din telefon i revnen og følg instruktionerne på Make It Real app'en
- SE (Valfritt) Placera mobilen i facket och följ instruktionerna i Make It Real-appen.
- NO (Valgfritt) Sett telefonen i media-holderen og følg instruksjonene i Make It Real-appen.



- EN Create a bead pattern in the PlayTray bead holder.
- DK Lav et perlemønster i bakkens perleholder.
- SE Skapa ett mönster i brickans pärlhållare.
- NO Lag et perlemønster i boksens perleholder.

- EN Organize the beads.
- DK Læg dine perler i orden.
- SE Sortera pärlorna.
- NO Sorter perlene.

- EN Attach the string to the tab for easy braiding.
- DK Fastgør snoren til en af ringene for nemmeret at flette.
- SE Fäst tråden för att fläta enklare.
- NO Fest snoren til en av ringene for å gjøre flettingen enklere.

What you need to make a beaded bracelet:

Dette skal du bruge til et perlearmbånd:

Detta behöver du för ett pärlarmband:

Dette trenger du til et perlearmbånd:

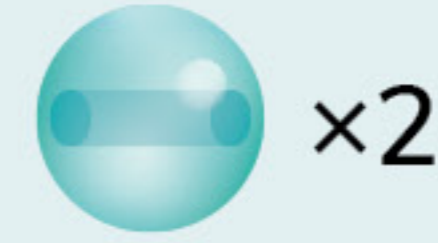
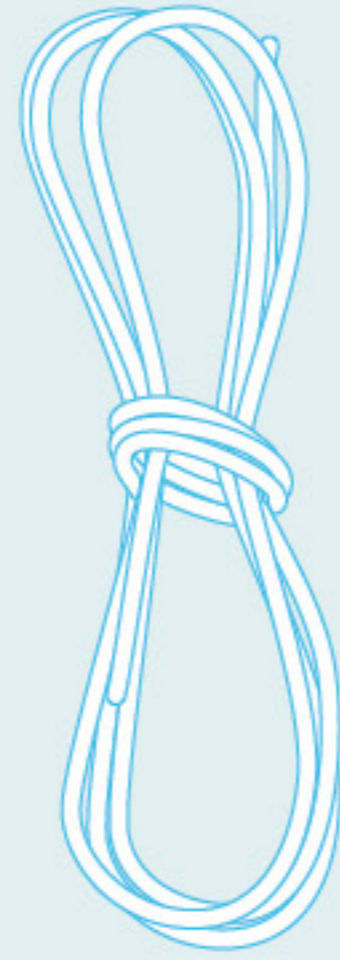

×2



×6



×2



×4



×12



×2



×4



×4

1

EN Cut 3 lengths of 22 cm (9 in) of clear elastic cord. Cut 15 cm (6 in) of clear elastic cord for the ring.

DK Klip tre 22 cm lange, ufarvede elastiksnore af. Klip 15 cm klar elastisk snor til ringen.

SE Klipp tre längder på 22 cm från den ofärgade elastiska tråden. Klipp 15 cm av den genomskinliga elastiska snöret till ringen.

NO Klipp av tre 22 cm lange, ufargede strikksnorer. Klipp 15 cm (6 tommer) klar elastisk snor til ringen.

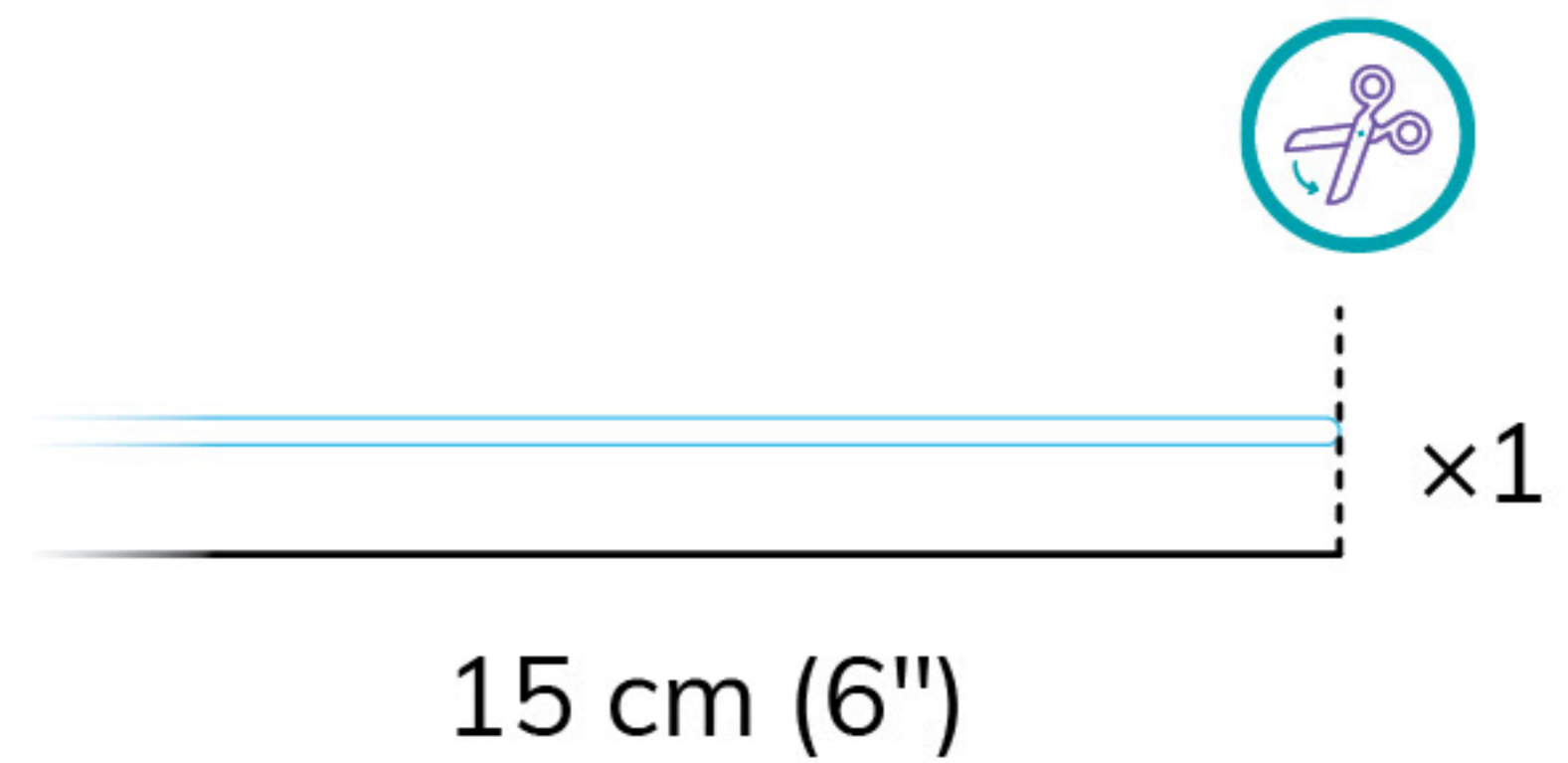
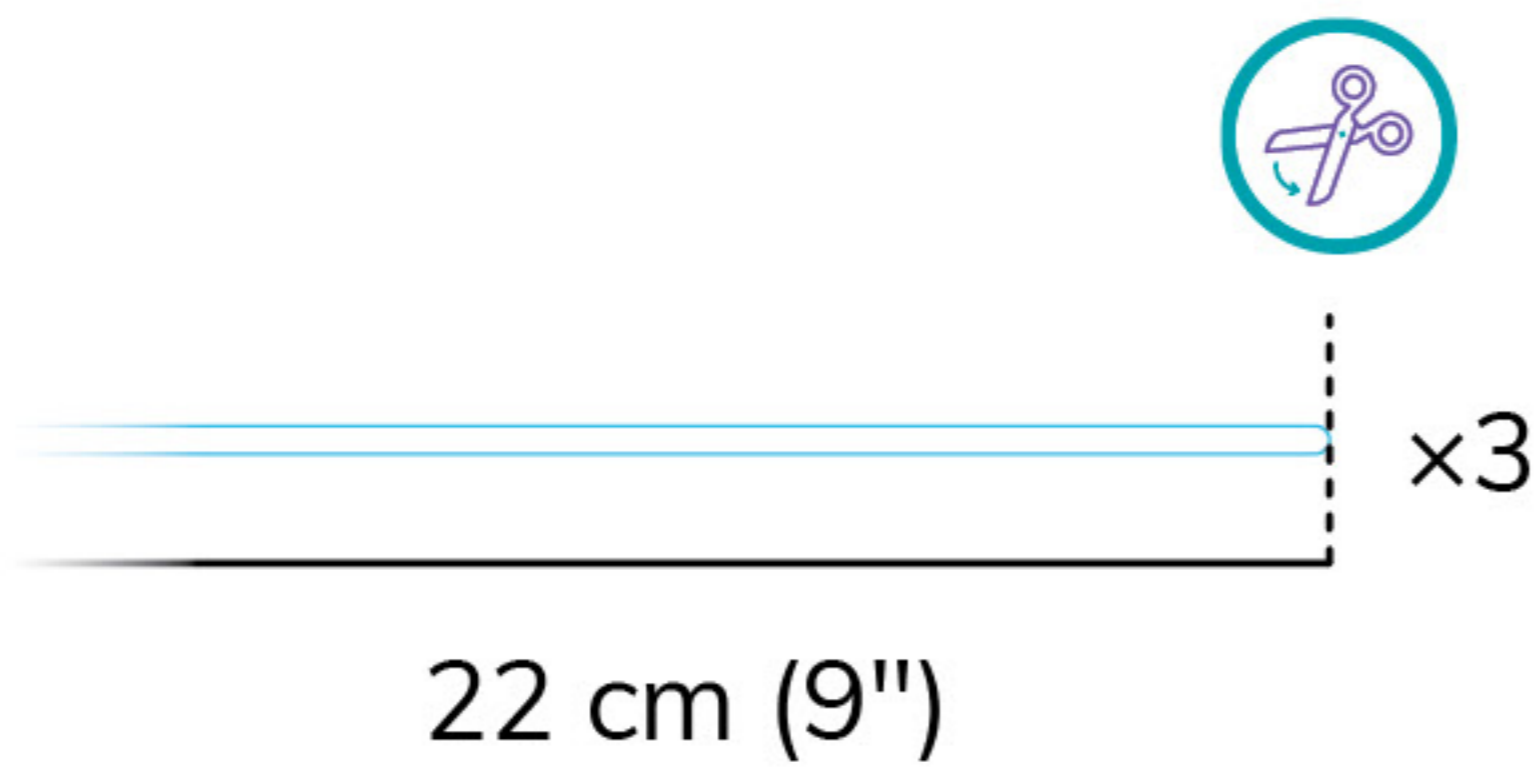

2

EN Attach one end of the elastic cord to the work surface with a piece of tape.

DK Sæt den ene af snorene fast på din arbejdsbakke med et stykke tape.

SE Fäst ena änden av tråden på arbetsytan med en bit tejp.

NO Fest den ene enden av snoren på arbeidsbenken med teip.

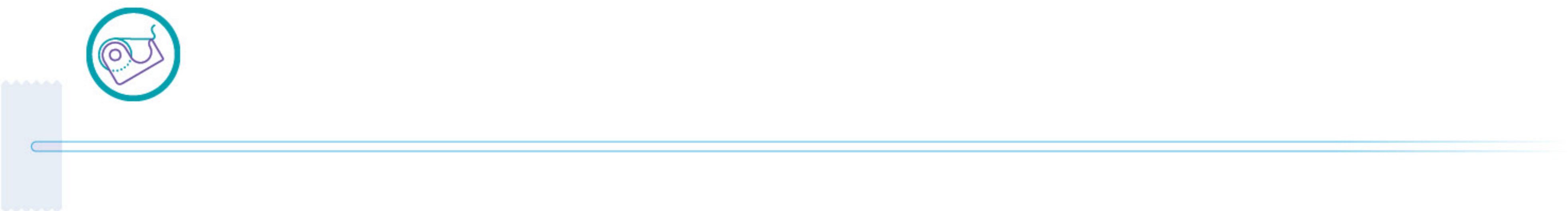

6 A

- EN Use the pliers to gently open the jump ring.
- DK Brug smykketangen til forsigtigt at åbne spltringen og putte den igennem perlens hul.
- SE Öppna ringöglan försiktigt med tången och trä den genom hålet på pärlan.
- NO Bruk tangen til å forsiktig åpne motringen.

6 B

- EN Slide the jump ring with the charm onto the bracelet and close it with the pliers.
- DK Sæt spltringen med perlen på armbåndet og luk ringen med tangen.
- SE Trä på ringöglan med pärlan på armbandet och stäng med tången.
- NO Trø motringen med perlen på armbåndet og lukk ringen med tangen.

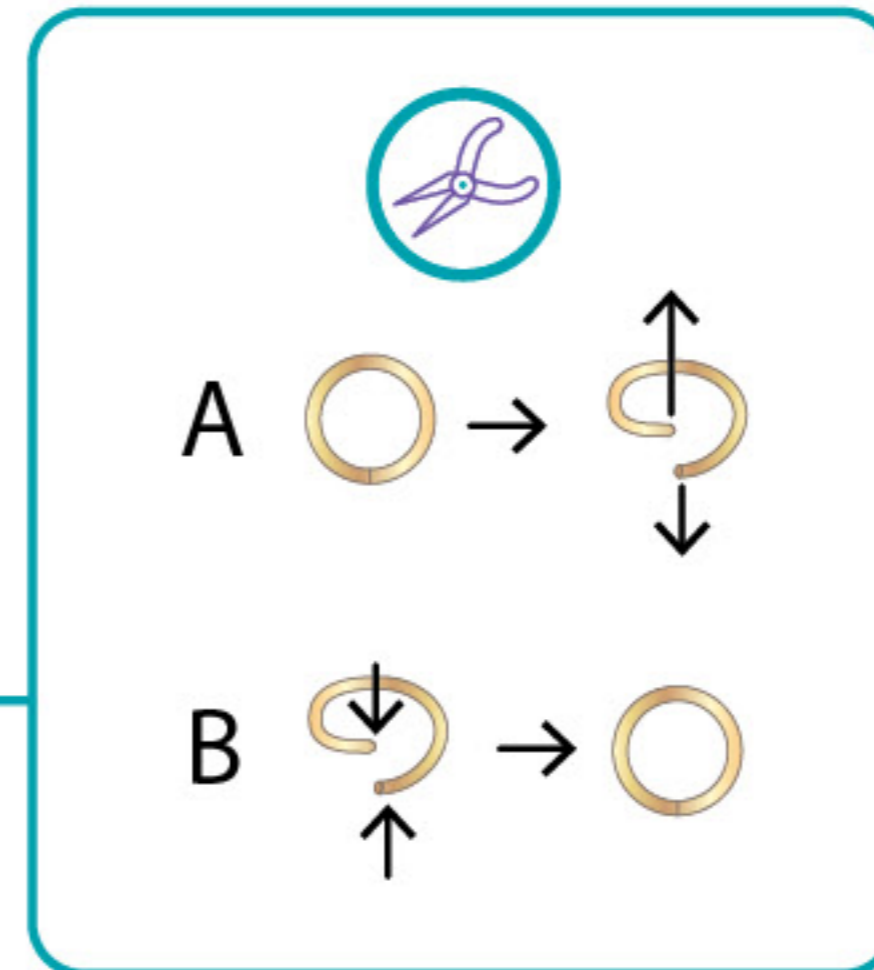

7



Mix up the beads to create
your own pattern!

Bland perlerne og
skab dit eget mønster!

Blanda pärlorna och
skapa ditt eget mönster!

Bland perlene og
lag ditt eget mønster!



- EN** Repeat steps 3-5 and follow the patterns to make 2 beaded bracelets and a beaded ring.
- DK** Gentag trin 3-5 og følg mønsteret for at lave dobbelt-perle armbånd.

- SE** Upprepa steg 3-5 och följ mönstret för att skapa två pärlarmband och en pärlring.
- NO** Gjenta trinn 3-5 og følg mønsteret for å lage to perlearmbånd og en perlering.

 3-5

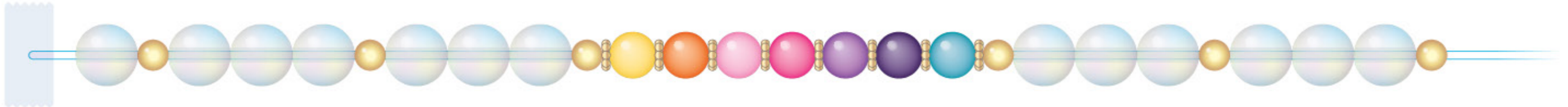

 ×13  ×6  ×8  ×1  ×1  ×1  ×1  ×1  ×1  ×1

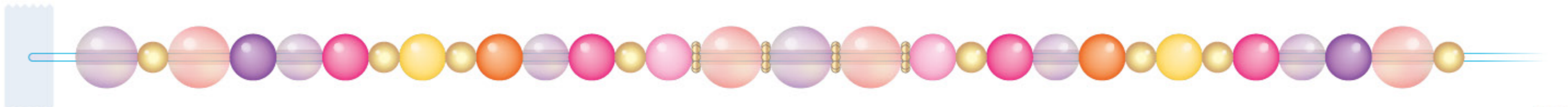

 ×2  ×8  ×4  ×4  ×2  ×4  ×4  ×2  ×2  ×2

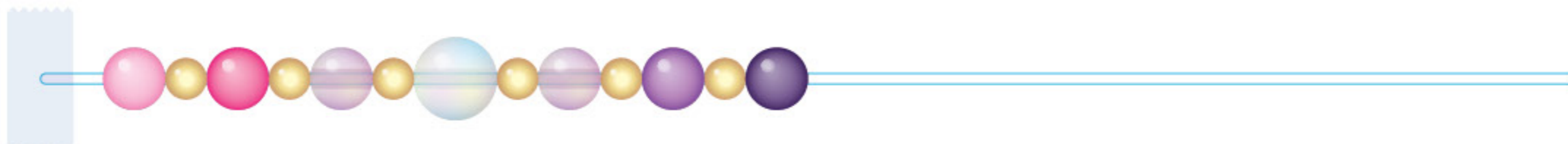

 ×6  ×1  ×1  ×2  ×1  ×4  ×4





Avoid soaking the bracelets in water.
Undgå at dyppe armbåndene i vand.
Undvik att sänka ner armbanden i vatten.
Unngå å dyppe armbåndene i vann.

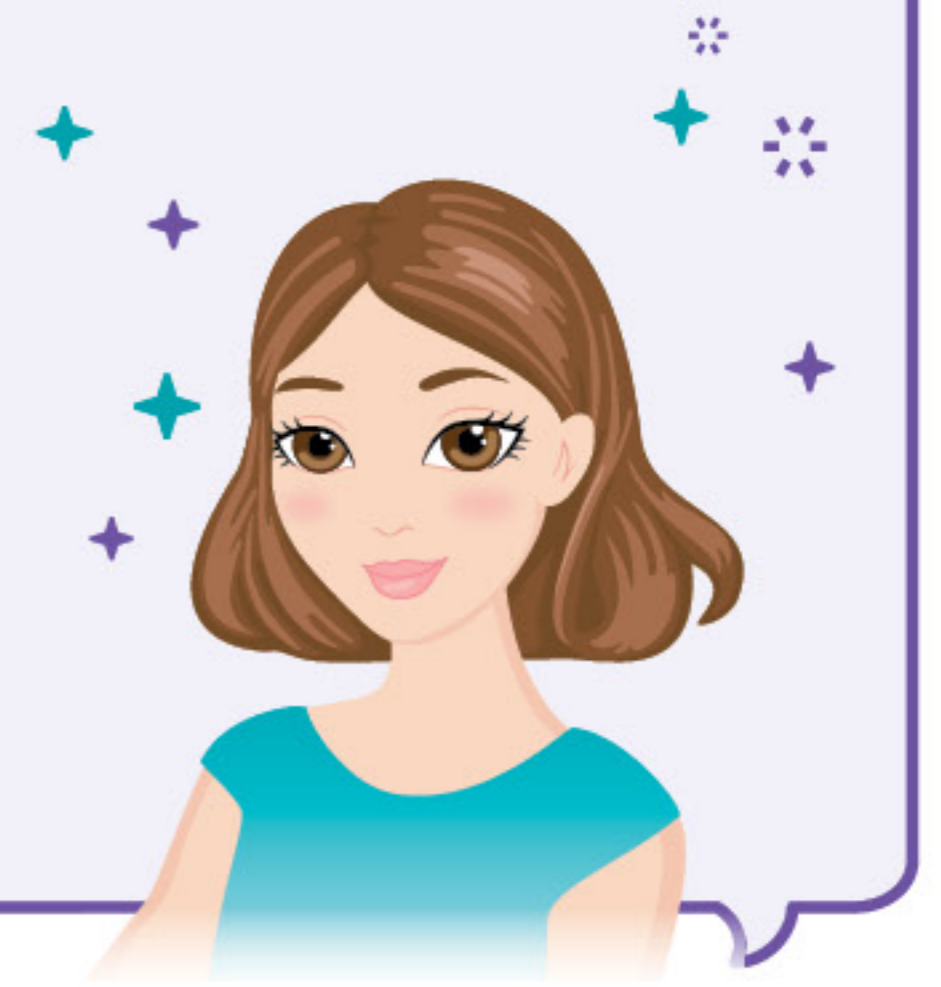

EN - WARNING!

CHOKING HAZARD – small parts. Not suitable for children under 3 years.
STRANGULATION HAZARD – Keep away from young children.

DK - ADVARSEL !

Ikke egnet til børn under 3 år.
Indeholder små dele. Risiko for kvælning.
Lang snor. Stranguleringsfare.

EU Responsible Person (Cosmetics):
EU Authorized Representative (Toys):
Ansvarlig person i EU (kosmetik):
EU autoriseret repræsentant (legetøj):

MAKE IT REAL

1700 Reisterstown Rd Ste 211
Pikesville MD 21208 **USA** 410-995-8685
Jactin House, 24 Hood Street
Ancoats, Manchester, M4 6WX **UK**
+44 (0) 161 302 4100

© 2022 MAKE IT REAL, LLC

Ansvarig person inom EU (kosmetika):
EU auktoriserade representant (leksaker):
EU ansvarlig person (kosmetikk):
EU autorisert representant (leker):

Made in China
Fremstillet i Kina
Tillverkat i Kina
Produsert i Kina

SE – VARNING!

Ej lämplig för barn under 3 år.
Innehåller smådelar. Kvävningrisk.
Lång sträng. Stranguleringsrisk.

NO – ADVARSEL!

Ikke egnet for barn under 3 år.
Inneholder små deler. Kvelningsfare.
Lang streng. Strangulationfare.

MDSS GmbH
Schiffgraben 41, 31075 Hannover, **DE**



makeitrealplay.com