



Using BHI Implants - Screw removal kit correctly

Warnings:

Surgical and restorative techniques required to remove dental screws are highly specialized and complex procedures. BHI's Surgical Tools and Accessories are intended for use by adequately certified dentists. Improper technique can cause patient injury and pain.

Surgical instruments are susceptible to damage and wear and should be inspected and cleaned before each use. Over time, repeat sterilization may affect cutting efficiency and color appearance.

Caution: Federal law (US) restricts this device to the sale, distribution, and use by or on the order of a licensed medical professional.

1. **Disclaimer of liability:**

This surgical Tools and Accessories are part of an overall concept and may only be used in conjunction with the associated original products according to the instructions and recommendations of BHI Implant Ltd.

Use of products made by third parties in conjunction with BHI's Implant surgical components will void any warranty or other obligation, expressed or implied, of BHI Implant Ltd.

The user of BHI Implant Surgical components is obligated to determine whether The products and/or accessories are suitable for the particular patient and circumstances.

BHI Implant Ltd. disclaims any liability, expressed or implied, and shall have no responsibility for any direct, indirect, punitive or other damages, arising out of or in connection with any errors in professional judgment or practice in the use of BHI's Implant products. The dentist is also obligated to study the latest developments in regards to BHI Implant products and their applications regularly.

In cases of doubt, the dentist has to contact BHI Implant Ltd. Since the processing And surgical application of this product is under the control of the clinician, it is under his/her responsibility.

BHI Implant Ltd assumes no liability whatsoever for damage arising thereof.

Please read all information carefully. Failure to properly follow the instructions may lead to unanticipated surgical consequences.

Important: This package insert is designed to provide Instructions for Use for the BHI Implants Ltd. Surgical Tools and Accessories. It is not a reference to surgical techniques.

2. Description:

The BHI Implant Ltd. Surgical Tools and Accessories include a variety of components (refer to full product list) that are manufactured from Surgical Stainless Steel and from Tungsten Carbide (WC).

Successful screw removing requires the use of the accessories and components as intended and instructed.

Below is a layout of the screw removal kit.

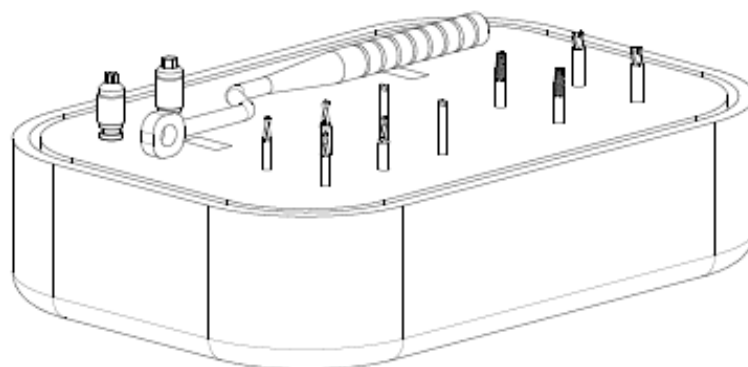
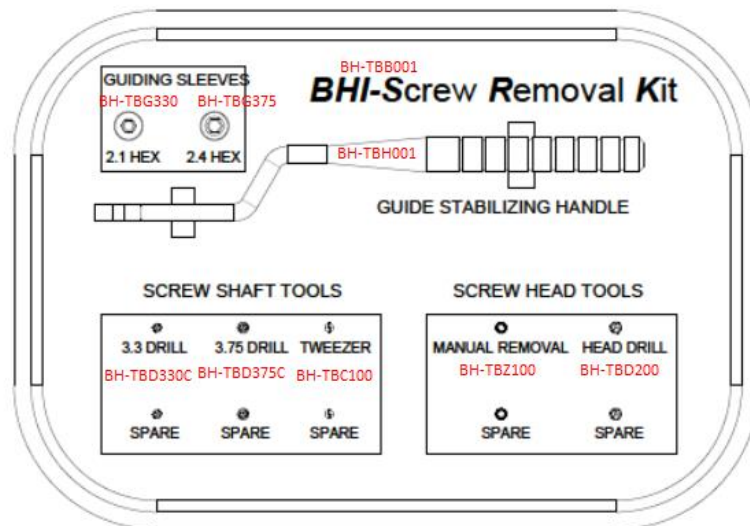

3. Indications for Use:

The BHI – Screw removal kit can be used for the following procedures:

1. Extraction of dental screw when screw head is damaged.
The extraction of a dental screw with damaged head can be required under two scenarios:
 - a. The head of the dental screw connecting the crown to the abutment is damaged.
 - b. The head of the dental screw connecting the abutment to the implant is damaged.
2. Extraction of dental screw shaft out of the implant after screw breakage.

Guide stabilizing Handle

The handle is used to keep the sleeve steady during the operation.

Guiding Sleeve for Implants

The sleeve is used to guide the conical drill into the screw shaft, without damaging the implant internal thread.

Conical Drill for screw shaft removal

The conical drill is used to extract the screw shaft by counter clockwise rotation.

Tweezer Tool for screw shaft removal

The Tweezer tool is used to pull out the remaining screw shaft.

Manual Screw removal

The manual screw removal is used for counter clockwise manual rotation of the screw head, in order to first try pulling it out manually.

Damaged screw head retriever Drill

The damaged screw head retriever is used to remove the screw head from its shaft while counter clockwise pulling the screw out.

Procedure 1

1. Insert tool BH-TBZ100 into the dental screw damaged head and rotate by hand counter clockwise. In case the screw was a bit loose, it will rotate and be released. In case the screw cannot be released, continue to next step.
2. Insert tool BH-TBD200 into a hand piece.
 - a. Ensure the drill unit is in reverse mode (counter clockwise).
Caution: reverse rotation is mandatory. Clockwise direction will not be efficient.
 - b. 800 RPM is the recommended revolutions.

Caution: too high RPM generates excessive heat which deteriorates tool efficiency.

- c. Drill into the damaged screw head while maintaining the drill parallel to the dental screw as much as possible. Stop approx. every 20 seconds to check the status of the screw head and to clean the drilling area with triple syringe.
- d. After a short period, the head of the dental screw will be removed while unscrewing operation if carried out as well.
- e. After screw head is removed, the abutment can be removed easily by hand while applying side force.

Caution: it may be required to continue on drilling a little more (go back to C), if abutment is not easily taken off by hand.

3. After abutment was taken off, check whether dental screw is completely removed with it. If dental screw shaft remained inside the implant, move to procedure 2.

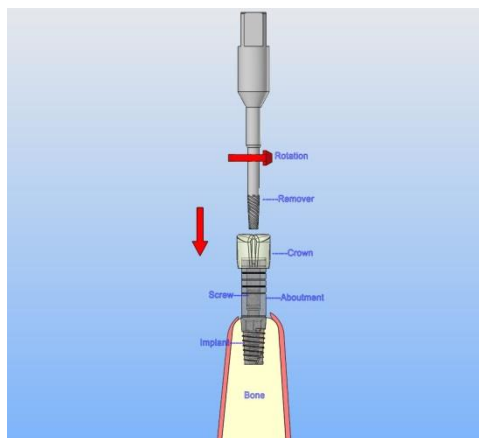

Step 1

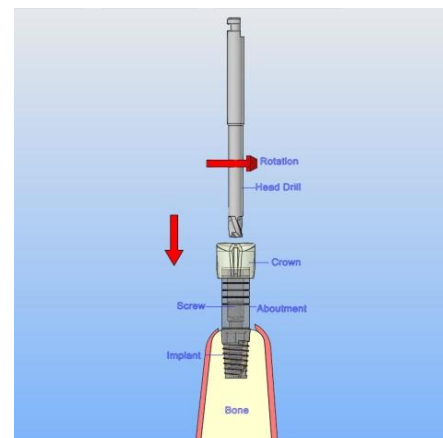

step 2

Procedure 2

1. If the dental screw shaft is extended a bit out of the implant, insert tool BH-TBC100 into hand piece.
 - a. Ensure the drill unit is in reverse mode (counter clockwise).

Caution: if the unit is not in reverse, the screw shaft will be pushed in and not out as required.
 - b. 800 RPM is the recommended revolutions.
 - c. Release the screw shaft out of the implant.
2. If the dental screw shaft is hidden completely inside the implant, check the implant connection diameter, in order to choose the right tool and sleeve to use:
 - a. For Implant 3.75mm, choose tool BH-TBD375C and Sleeve BH-TBG375.
 - b. For implant 3.3mm, choose tool BH-TBD330C and Sleeve BH-TBG330.

Caution: choosing the right sleeve is crucial. Wrong sleeve usage may cause damage to the implant.
3. This step is relevant for both options above.

- a. The use of mouth opener is recommended.
- b. Insert tool into hand piece.
- c. Ensure the drill unit is in reverse mode (counter clockwise).
Caution: if the unit is not in reverse, the screw shaft will be pushed in and not out as required.
- d. 800 RPM is the recommended revolutions.
Caution: too high RPM generates excessive heat which deteriorates tool efficiency.
- e. Locate Sleeve hex on top of the implant hex, while holding and stabilizing the sleeve with handle BH-TBH001.
- f. Insert the drill into the sleeve for guiding and start drilling in reverse mode into the screw shaft. Stop approx. every 20 seconds to check the status of the screw shaft and to clean the drilling area with triple syringe. The screw shaft should gradually unscrew and be released from the implant thread.
- g. After a while, the screw shaft should climb up and be released completely.
- h. The screw shaft might still require a final release. In that case, insert tool BH-TBC100 into hand piece.
- i. Ensure the drill unit is in reverse mode (counter clockwise).
- j. 800 RPM is the recommended revolutions.
- k. Release the screw shaft completely.

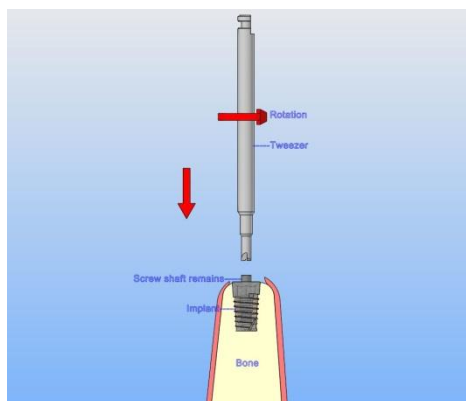

Step 1

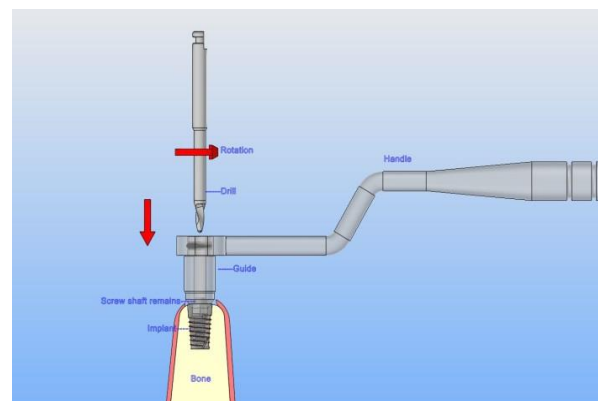

Step 2 and 3

4. Precautions:

All efforts must be made to minimize damage to the host tissue, paying special attention to thermal and surgical trauma and to the elimination of contaminants and sources of infection. The procedure requires a high degree of precision and care. All drilling procedures should be performed at low speed (approximately 800 rpm) or manually. All drilling procedures require the use of dedicated, sharp instruments under constant and profuse irrigation for cooling. All instruments used must be maintained in good condition and care must be taken that instrumentation do not damage implants or other components. The Techniques specified in this procedure require specialization and skills therefore formal training is recommended.

5. Adverse Reactions:

Implant techniques have normal contraindications and risks. These are extensively documented in the dental literature. Incorrect clinical placement or loading resulting in loss of implant anchorage or loss of the prosthesis can occur after surgery.

Other complications that can occur include infection, bone loss, patient discomfort, implant mobility, local soft tissue degeneration, excessive fastening forces and unfavorable implant placement or alignment.

6. Contraindications:

Pre-operative patient evaluation is necessary to determine any factors that may put the patient at risk or factors that may affect healing capabilities.

Treatment is contraindicated where the patient has a known preexisting allergy to the used parts. The use of drills and/or other instruments with non-BHI's products is contraindicated.

7. Warnings:

1. Due to the small size of the components, care must be taken that they are not swallowed or aspirated by the patient.
2. This Kit does not support in cases where the implant is inspected as damaged.

8. Non-Sterile products Components & Instruments

The devices delivered non-sterile have a "non-sterile" marking on the label. 

9. Warnings and recommendations for disinfection, cleaning and sterilization**a. General Warnings:**

- i. The surgical tools and accessories must be disinfected, cleaned and sterilized by trained and qualified staff.
- ii. Check for the presence, the cleanliness, the operational state and the qualification (calibration, maintenance, etc.) of all the necessary material before starting the cleaning and sterilization cycle.
- iii. The handling and processing of contaminated devices must be done by the use of personal protective equipment (gloves, glasses, mask, etc.).

- iv. The drying, packaging and sterilization process must be performed in a clean and orderly – designated environment.
- v. Use cleaning/disinfection products that are suitable for the surgical instruments and the materials they are made of. Do not use products containing chlorine, iodine, phenols, strong acids or alkaline (do not use sodium hypochlorite, bleach), oxalic acid, sodium hydroxide or hydrogen peroxide, or normal saline. Beware of the too highly chlorinated tap water. Avoid any product containing aldehyde because of their ability to bind proteins.
- vi. For all products and materials (for cleaning/disinfection, washer-disinfector, ultrasound vat, sterilization pouch, autoclave etc.), carefully follow all manufacturer's instructions (dosage, soaking time, temperature etc.) and expiration dates.
- vii. For the washer-disinfector: Only use agents recommended by the manufacturer and prefer the use of slightly alkaline products (pH between 7 and 10.5).
- viii. Avoid as far as possible shocks and contacts with other instruments.
- ix. Please clean products made from the same material in the same container.
- x. Do not leave contaminated instruments to dry before the cleaning / sterilization cycle.

b. Cleaning

Manual cleaning using ultrasonic cleaner

- i. As soon as possible after their use (if more than 30 minutes, wrap the instruments in a damp cloth to prevent debris/contaminants from drying), place the instruments in a suitable container, avoiding shocks and transfer them to the area dedicated for the cleaning process.
Dismantled instruments if necessary (in the case of the torque ratchet) and completely soak the instruments in a freshly prepared cleaning agent (according to solution's manufacturer instructions). Avoid contact with phenol alcohol, chlorine, acid or quaternary ammonia.
- ii. Carefully remove all the post-operative residues (blood, bone, etc.) from the instruments (use a soft nylon brush if necessary) and from within (for products with an internal irrigation or hollow products) by flushing a mild alkaline detergent or a natural one.
- iii. Rinse thoroughly with cool-to-lukewarm purified water for at least 2.5 minutes.
- iv. Place the components in an ultrasonic cleaner with an enzymatic detergent diluted with purified/sterile water per the manufacture's guidelines.
- v. Sonicate for 10 minutes and rinse with purified/sterile water for three minutes.

- vi. Immediately after washing, dry all the instruments surfaces with a lint-free clean single-use absorbing wipes by scrubbing carefully.
- vii. Inspect the devices visually for any remaining bone fragments or debris and scrub as necessary

Automated cleaning using automated washer

Applicable for all reusable instruments prior to first use and after each use,
Proceed with the following cleaning procedure-

- i. Place the components in a qualified in an automatic washer with neutral or mild pH enzymatic detergent diluted per the manufacturer's instructions
- ii. Perform the washing cycle, with following cycle
Parameters (Typical for Vario TD cycle):
 - 2 minutes cold prewash tap water at Cold, <45°C
 - 5 minutes cleaning wash at Heated, 55°C
 - 2 minute first rinse at Cold, <45°C
 - 2 minute second rinse at Cold, <45°C
 - 5 minutes thermal rinse at Heated, 93°C with Reverse Osmosis Water
 - 22 minutes dry Heated, 50°C
 - Inspect the devices visually for any remaining bone fragments or debris and scrub as necessary

Functional Testing & Maintenance

Visual inspection for cleanliness should be performed with magnifying glasses.
If necessary perform reprocessing process again until the instruments are visibly clean.

c. Sterilization

- i. The components shall be sterilized by moist heat (134°C for 6 minutes followed by 30min drying cycle) using steam autoclaves suitable for medical devices sterilization.
- ii. It is not recommended to use the surgical tools and accessories after more than 15 sterilization cycles. In any case, all components must be checked before use.
- iii. Verify the good progress of the cycle, the integrity of the pouches as well as the physio-chemical indicator of sterilization (if necessary, repeat the process from point 5.a.v). Indicate the sterilization date, batch code etc., on every pouch (and any information necessary for control and traceability), which will then be stored in conditions, preserving the products safety and sterility (a clean, dry, safe and stress-free place, at room temperature and out of direct sunlight).

- iv. Periodic testing, cleaning, and calibration of the autoclave/equipment are recommended to ensure the unit remains in proper working order.
- v.

10. Limitations on reprocessing:

Maximum recommended number of sterilization cycles by autoclave: 15.

All products should be visually inspected for signs of wear and tear prior to reuse and discarded if necessary.

11. How Supplied:

The BHI Surgical Tools and Accessories are provided non-sterile and must be clean and sterilized prior to use and between subsequent uses in accordance with the above instructions.

Care must be taken when handling contaminated instruments.

12. Storage

Prior to first use the products should be kept in their original package, in a dry area at room temperature.

Following cleaning and sterilization the products should be kept in the surgical kit box or sterilization packets, in a dry area at room temperature.

Dispose of worn/unusable products in sharps disposal containers in accordance to local regulations. Take appropriate precautions to avoid decontamination prior to next use.

13. Complications and Adverse Effects

The risks and complications with surgical tools and accessories, prosthetics, and implants include, but are not limited to: (1) allergic reaction(s) to implant and/or abutment material; (2) implant and/or abutment breakage; (3) abutment screw and/or retaining screw loosening; (4) infection requiring revision of the dental implant; (5) nerve damage that could cause permanent weakness, numbness, or pain; (6) histologic responses possibly involving macrophages and/or fibroblasts; **Short-term risks** associated with the use of these products include anesthetic and surgical risks psychological and psychiatric risks, pain, gingivitis, speech problems. **Long-term risks** include nerve damage, bone loss, local or systemic bacterial infections, infectious endocarditis.

The following table lists the organ systems that may be affected together with the associated risks;

Organ System	Effect
Cardiovascular	Arrhythmias, coronary heart disease, cardiovascular failure
Respiratory	Chronic obstructive pulmonary disease
Gastrointestinal	Hepatitis, malabsorption, inflammatory bowel disease

Genitourinary	Chronic renal failure
Musculoskeletal	Arthritis, osteoporosis
Hematological	Anemia, leukemia, blood clotting disorders
Endocrine	Diabetes, thyroid diseases, pituitary and adrenal disorders

14. Change in performance

It is the user responsibility to inform the patient about the precautions, side effects, and contradictions, should the performance of the implant be in question. It is the responsibility of the patient to seek medical care if any of the side effects occur.

15. E-Labeling

The Instructions for Use can be accessed online by visiting BHI's website. Additional translations are also available in electronic format for download. To request a paper copy of the Instructions for Use, send an email to the address provided on the label and additional instructions will be provided. A paper copy may also be requested, by phone, using the telephone number listed below.









This document can be provided in a paper form at no additional cost within 7 days of request.

16. Traceability

In order to guarantee the security of patients, the user must keep the reference and batch number for all the products that has been set or used. These specifications are stipulated on the adhesive detachable labels on the BHI's products. Please to not use any of BHI's products when the packs are damaged or when the labels are illegible.

17. Labeling

Symbols used as part of the surgical tools and accessories labeling:

	Batch Code		Non-Sterile
	Catalogue Number		Consult Instructions For Use
	Date of Manufacture		Keep Away from Rain
	General Warning Sign, consult accompanying documents		Keep Away from Sunlight



Do Not Use if Package is
Damaged

RxOnly

Prescription Only. U.S. Federal Law Restricts this Device to Sale by or on the
Order of a Physician or Properly Licensed Practitioner



Manufacturer:

BHI Implants Ltd.
2 Ha'amal St. Afula
1857107, Israel
Tel: +972-4-6094458
Fax: +972-4-6597812
www.bh-implants.com