

Our product service range:

OTTO WASTE SYSTEMS

Systems for domestic and industrial waste

OTTO PAL SYSTEMS

Systems for public waste

OTTO PUBLIC FURNISHING

Litter bin systems and street furniture

OTTO HAZARDOUS WASTE SYSTEMS

Approved special containers

HN LOGISTICS SYSTEMS

Collecting vehicles and lifters

OTTO SERVICES

Logistics, financing, container management

Our expertise:

CONSULTING

Designing innovative tailor-made solutions

DEVELOPMENT

Designing of optimum receptacles

PRODUCTION

Manufacturing at OTTO owned plants

DISTRIBUTION

Local connection to a global network

SERVICE

Meeting individual needs with customised solutions

OTTO Waste Systems (S) Pte Ltd

541 Bukit Batok Street 23

#03-00 Tacam Industrial Building

Singapore 659546

Tel: (65) 6898 1267 Fax: (65) 6268 5193

Email: sales@ottoasiapac.com

www.ottoasiapac.com



OTTO PUBLIC FURNISHING



UWS
Underground
Waste System



Underground Waste System

THE NEW GENERATION

1 *quality of life*

- More attractive streetscene
- Unobtrusive positioning
- More space for pedestrians
- Receptacle apertures at an optimised height
- Potential for vandalism reduced
- Unpleasant odours minimised
- Less noise pollution

2 *flexibility*

- Freedom in planning concepts for architects and planners
- Modular design
- Offers 'barrier' to fly-tipping
- Available for round the clock use
- Optional access control
- Wide choice of colours and paint effects

3 *efficiency*

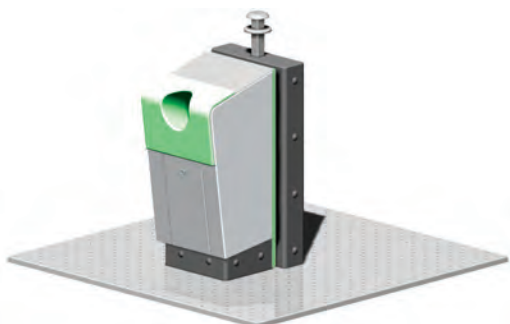

- Change to bring system reduces costs
- Compatible with existing waste logistic systems
- Can be emptied by a one-man operation
- Fill level of containers can be monitored and optimised
- Low levels of maintenance required
- Fire risk for paper and textile collection minimised
- Experienced technology offers reliable functioning
- Anti-corrosive galvanised finish



MORE THAN A LITTER BIN

The underground waste system is a modular solution offering flexible and efficient waste collection.

Our experience can help you -

OTTO's underground waste system has already been installed successfully in many countries around Europe. The experience gained from the existing projects offers you the best possible reassurance that your requirements will be met.

The product lines

EUROPE



Standard version

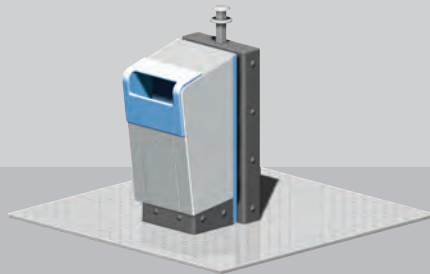

Slot Version



Round version

EVOLUTION



Standard version

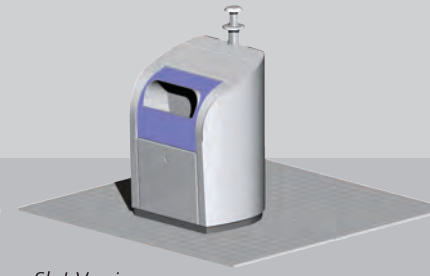

Slot Version

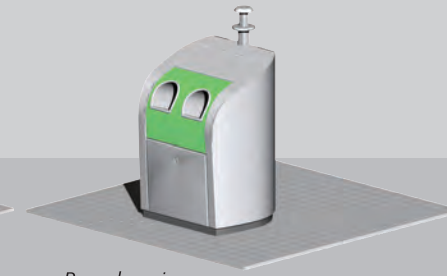

Round version

EXCEPTION



Slot Version

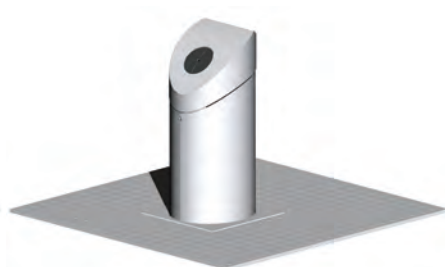

Round version

The Europe and Evolution ranges are available with various openings and are suitable for collection all standard types of waste and recycling from paper to plastics. The size of the Exception range makes it particularly attractive, especially with the invisible, integrated hook system. The smaller range is suited for collecting various types of recycling.

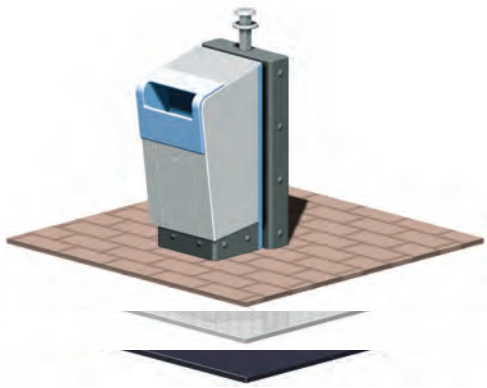

Ground plate

- Easy to integrate into existing ground surface
- Plenty of scope for different materials and designs, ranging from stone and metal up to granulated, recycled rubber.



Access control and Pay-by-Weight

- Access to the system is controlled by a card reader. Volumes can be weighed and deducted from customers' allowances.
- Coin-operation is also available for occasional users, alone or in combination with the card reader.
- Data from the system can be transferred automatically and used to plan collection rounds.



- The self-closing drum in the receptacle allows volume of residual waste to be monitored. It also protects against vandalism and accidents.
- Access to the system can be managed economically through a manual key lock.

Safe and perfected technology

OVER 10,000 UNITS INSTALLED



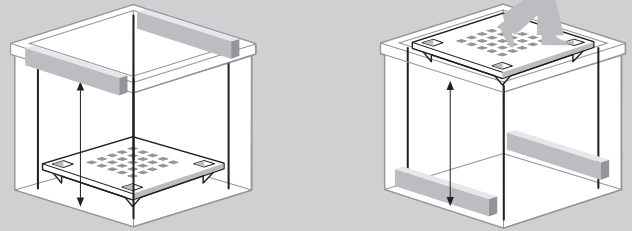

Safety floor with counterweights

Success in Europe

The OTTO system is already the fourth generation of underground collection containers and is the result of many years of experience. The installation of units has been optimised through prefabricated parts and precise assembly instructions.

Proven Technology

The modular concept with its separation of usage and mechanical areas simplifies installation and service. The intelligent lifting mechanism integrates raising, lowering, emptying and locking and is compatible with standard lifting systems.

Operational Efficiency

- Optional electronic system control and monitoring, with control of filling level.
- Raising, emptying and locking are integrated into one mechanism.
- Can be done by a single-operator.
- Maintenance flap allows for easy access to the chute.

Safety

The safety base plate covers the hollow cavity during the lifting and emptying operation. The counterweights and optional locking system allows a loading of 150 – 500 kg on the plate.



Self-closing safety drum

Functional and quiet

This practical system is suitable for disposal of variable volume of waste and can be used for plastics, organic waste, textiles and domestic waste. Noise pollution is reduced by throwing the waste underground.

Simple Operation

HIGHLY EFFICIENT

Modular receptacles

The modular concept divides the receptacle from the mechanical operation, leaving the mechanism freely accessible for maintenance and simplifying installation.

The maintenance flap in the lower front section allows for easy access to the chute.

The Archiplate can incorporate instructions for use, signs or logos and can be made out of a material tailored to the project.

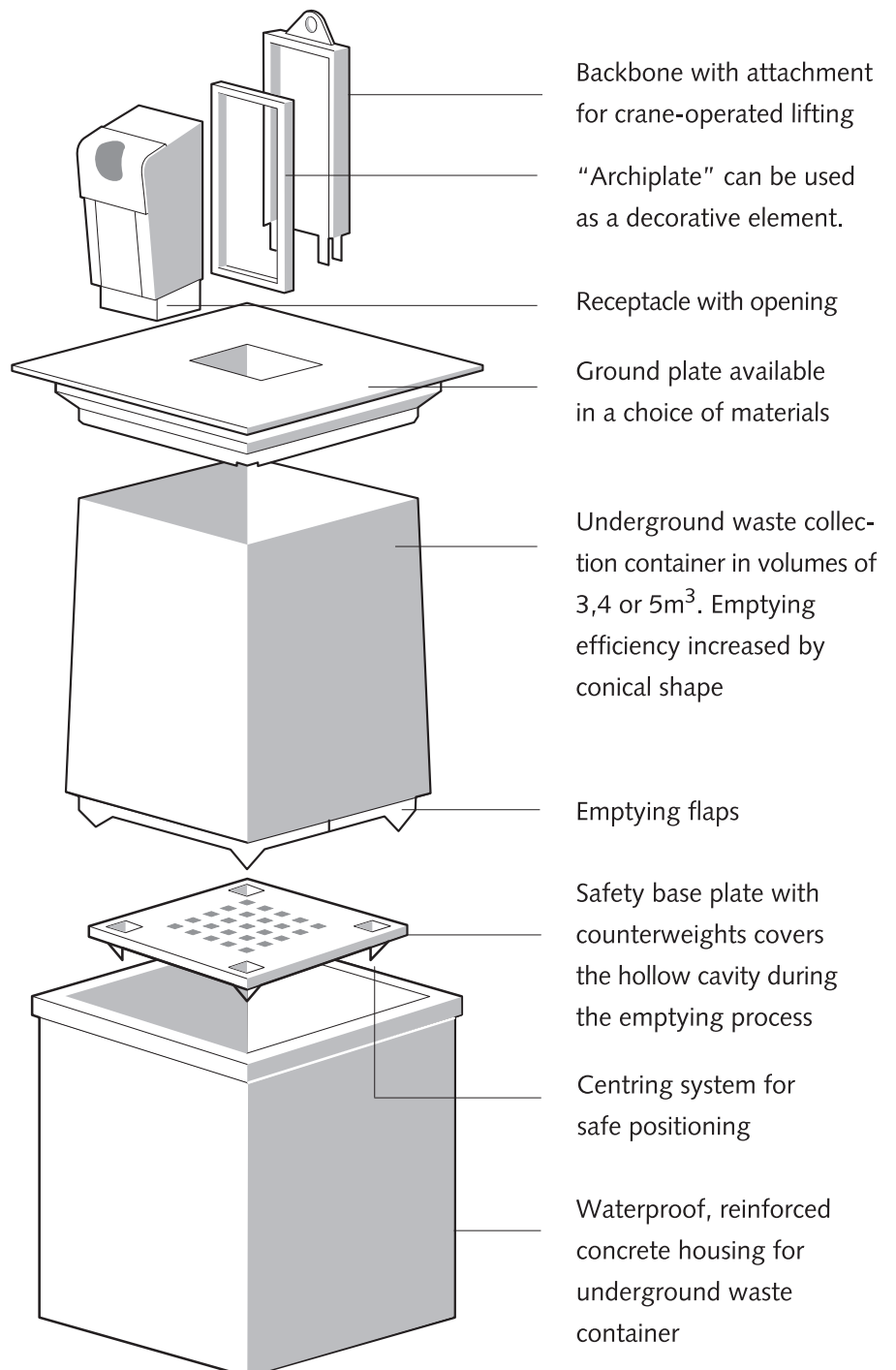

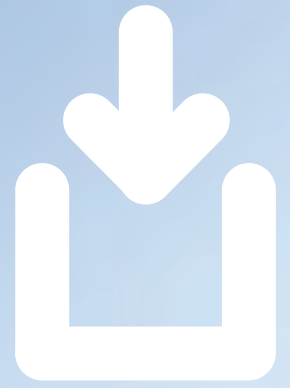

HOOK SYSTEMS

Hook



2 Hooks



2 Parallel Hooks



3 Hooks



Kinshofer



Customised



TECHNICAL DATA

Container table

	3 m ³	4 m ³	5 m ³
Concrete housing weight	4,405 kg	5,560 kg	6,478 kg
Concrete housing height	1,815	2,350	2,885
Container weight	525 kg	575 kg	625 kg
Container height	1,600	2,135	2,670
Concrete construction	1 Module	2 Modules	2 Modules
Safety base plate	yes	yes	yes

Base plate table

	Rubber	Metal	Stone
Colours	4 Standard	choice	choice
Design	various	various	choice
Plates / Tiles	yes	-	yes
One piece / flat	yes	yes	-
Support structure	galvanised		

Quality of manufacture

Details such as invisible, integrated water outlet or aquatack sealing of edge areas guarantee safe functioning and durability. The galvanisation of all metal parts protects against the elements. This protection from the weather is increased by a highly resistant powder coating.

Options:

Noise reduction and anti-graffiti coating.

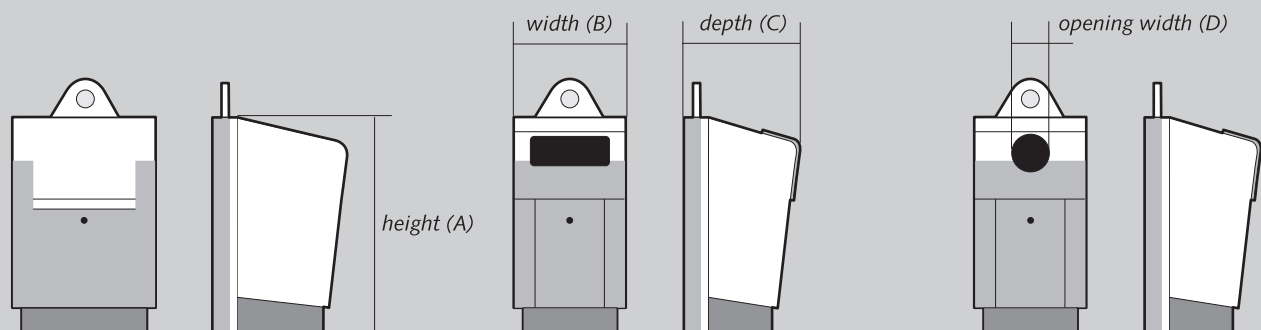

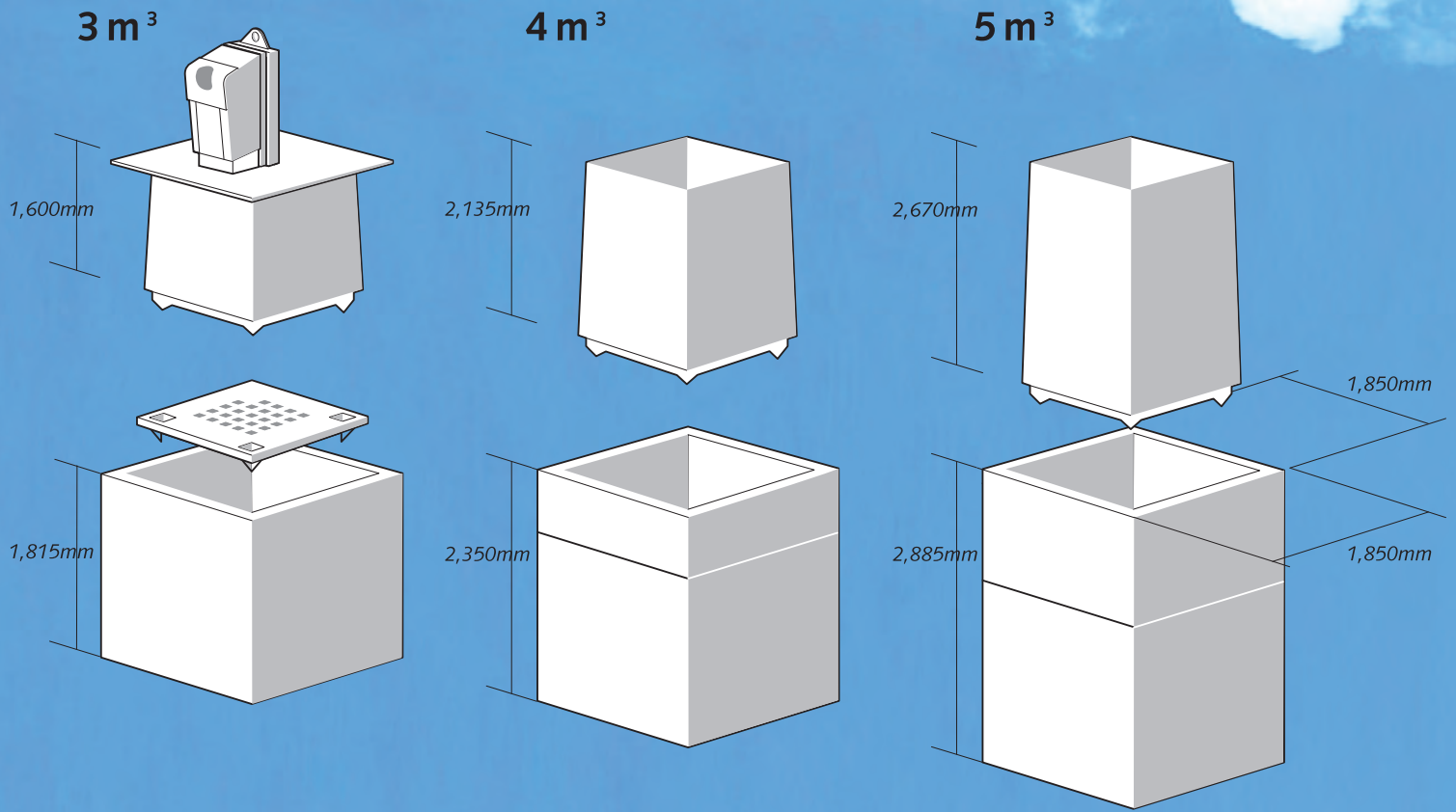

Service

Your OTTO representative can advise you in choosing the optimum solution. You will be supported through each phase of the project up to completion.

Dimensions

	Europe round/mm	Europe slot/mm	Europe standard/ mm	Compact round/mm	Compact slot/mm	Evolution round/mm	Evolution slot/mm	Evolution standard/ mm	Exception round/mm	Exception slot/mm
A	1070	1070	1070	1005	1005	1050	1050	1050	1039	1039
B	500	500	720	508	508	720	720	720	480	480
C	620	620	795	508	508	690	690	690	485	485
D	200	370 x 130	500	160	160 x 300	150	410 x 165	500	160	280 x 160