

OTTO MGB 0,77 and 1,1

These well-tried containers manufactured to DIN 30700, part 1



MGB 0,77 and 1,1

With or without comb-bar receiver. With wheel brake or central braking system

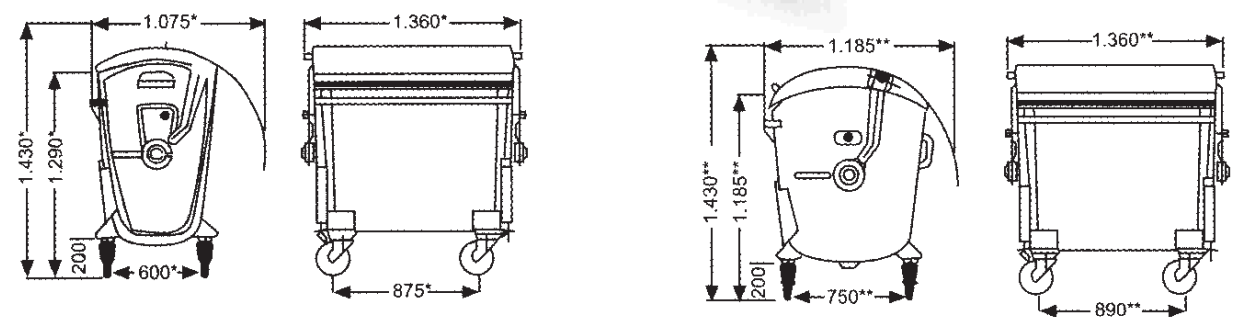

* Tolerance closely to DIN 30700 part 1
Subject to technical modification

** Tolerances according to DIN 30700 part 1

Authorised Distributor



www.ottoasiapac.com

SteelCombi

ALL STEEL STAINLESS STEEL STEEL PLASTIC

For the collection of recoverable materials, residue waste and medical waste.
Available in 660, 770, 1100 and 1200 litre containers.





the New Dimension in Waste Management

SC 0,66-KF

SteelCombi 0.66m³ with flat plastic lid

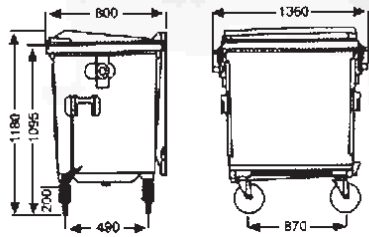

SC 1.1-KF

SteelCombi 1.1m³ with flat plastic lid

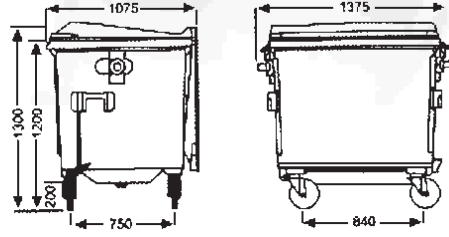

SC 1,1-SR

SteelCombi 1.1m³ with round steel lid

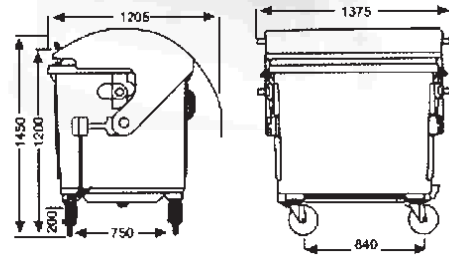

SC 1,1-KR

SteelCombi 1.1m³ with round plastic lid

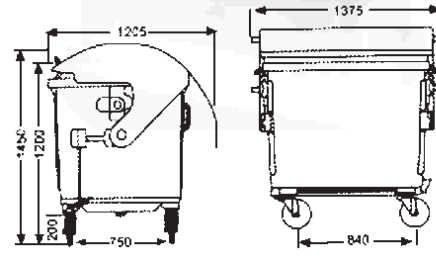

SC 1,2-SR

SteelCombi 1.2m³ with round steel lid

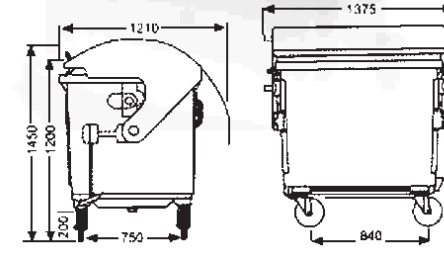

SC 1,2-KR

SteelCombi 1.2m³ with round plastic lid

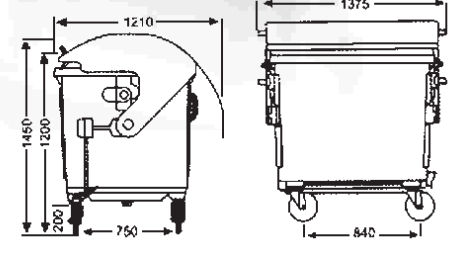

For you we have developed a container from our wealth of experience, a container that offers new solutions.

The large choice in COMBINations is typical of OTTO products. All spare parts are interchangeable with the OTTO plastic 1100 litre container keeping the stock of spares required to a minimum.

Available in various sizes and with several lid options, this container is suitable for many different applications.

The Container

All versions of the new SteelCombi come complete with integrated comb-bar receiver as well as quiet running heavy-duty, solid rubber tyre castors with hubs manufactured from plastics or hot-dip galvanized steel 200mm diameter, swiveling through 360° degrees.

Special versions on request. All containers with GS sign (tested and approved safety.)

Quality In Every Detail

The combination of robust galvanised steel and our well-proven plastic parts are the basis of the new OTTO SteelCombi. Four swivel castors provide the container with the required mobility and its volume ensures economical collection. The cone shaped body and the water outlet plug in the bottom ensure easy cleaning, and makes an important contribution to hygiene.

This container reflects 60 years of experience within the OTTO Group in the field of waste management.

Special Features

- Modern design
- Integrated comb-bar receiver
- Spare parts interchangeable with OTTO 1100 Litre plastic container, resulting in less stock being required
- Low noise level
- Designed to accept micro-chip
- Available in various sizes
- Assembled containers are stackable 3 high
- Coloured lids
- Spiral spring adjustment for lid-tension
- Personalised stamping of several lines on metal-lid available
- Easy handling
- Various recycling lid openings available

Options

- Lid opening devices for flat / round lid
- Gravity locking mechanism
- Triangular lid lock
- Towing attachments
- Flat lid noise silencer
- DIN lifting trunnions
- Central braking system
- Wheel steering guides