

# QuadPro

Directional 4x4 MIMO Panel Antenna

Designed by WAVEFORM in California

SKU: ANT-4-660-PA-SM



600 to 6000 MHz



4G and 5G Support



Up to 9.1 dBi Gain



Outdoor Rated



SMA-Male Connectors,  
with integrated weatherproofing

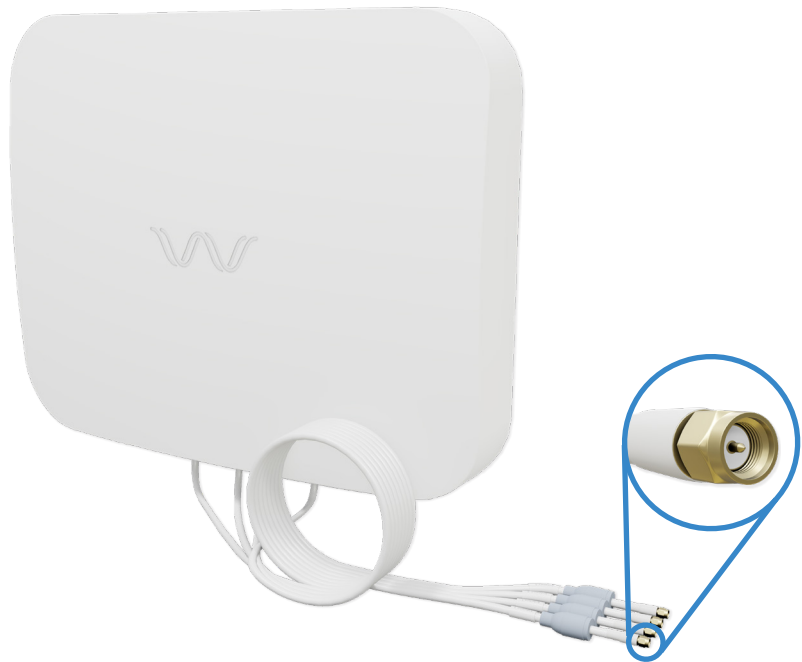

## Specifications:

### Electrical:

Freq. Range	600-900 MHz	1700-2700 MHz	3500-4200 MHz	5000-6000 MHz
Gain (Avg. Peak)	5.5 dBi ± 0.6 dB	7.7 dBi ± 0.5 dB	6.8 dBi ± 0.6 dB	7.9 dBi ± 0.5 dB
Azimuth Beamwidth	110 ± 10 deg	70 ± 10 deg	130 ± 20 deg	165 ± 10 deg
Elevation Beamwidth	155 ± 15 deg	70 ± 10 deg	145 ± 10 deg	145 ± 20 deg
Front-to-Back Ratio	> 10 dB	> 17 dB	> 14 dB	> 14 dB
VSWR	≤ 2.8	≤ 1.5	≤ 1.5	≤ 1.7
MIMO Isolation (Peak)	41.8 dB	42.1 dB	53.0 dB	85.3 dB
Efficiency (Peak)	80 %	76 %	69 %	72 %
Input Imped.	50 Ω			
Polarization	4x4 Cross-Polarized, ± 45 deg			
Antenna Type	Directional			
Power Rating	50 W (Peak)			

### Environmental:

Protection Class	IP65
Impact Rating	IK08
Rated Wind Velocity	200 kph (125 mph)
UV Rated?	Yes
Operating Temperature	-40 to +65 deg C (-40 to + 150 deg F)
Lightning Protection	DC Ground

### Mechanical (Antenna):

Antenna	Radome Color	White (RAL 9003)
	Radome Material	ASA (UV Stabilized)
	Dimensions (w x h x d)	38.5 x 30.8 x 6.7 cm (15.2 x 12.1 x 2.6 in)
Cable	Connector Type	SMA-Male Ultraflex RG141
	Jacket Color	White
	Jacket Material	TPE
	Length	1.0 m (3.3 ft)
	Bending Radius	22 mm (0.9 in) [Repeat] 40 mm (1.6 in) [Install]
Cable Boot	Material	Silicone Rubber
Net Weight	2.28 kg (5.03 lbs)	

### Mechanical (Assembly):

Captive Bolt	Material	316 stainless steel
	Specification	M6
Nut	Material	316 stainless steel
	Specification	M6
Flat Washer	Material	316 stainless steel
	Specification	M6
Lock Washer	Material	316 stainless steel
	Specification	M6



WAVEFORM

3411 W. Lake Center Drive,  
Santa Ana, CA 92704

www.waveform.com  
1-800-761-3041

# QuadPro

Directional 4x4 MIMO Panel Antenna

Designed by WAVEFORM in California

600-900 MHz

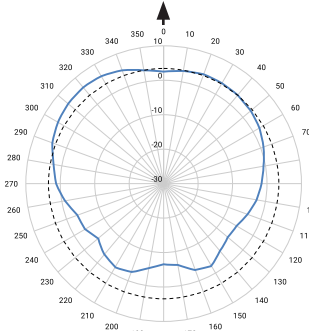

1700-2700 MHz

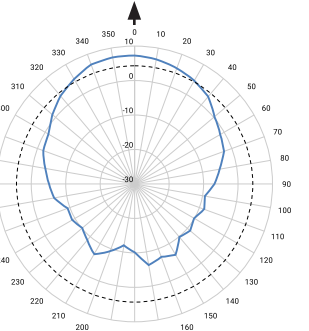

3500-4200 MHz

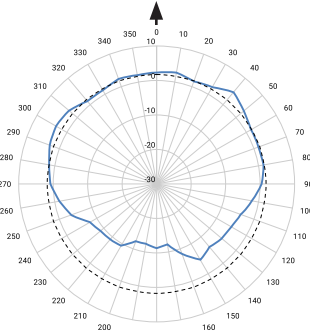

5000-6000 MHz

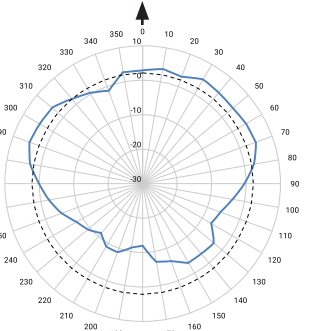

Azimuth Plane  
"Top-down view"

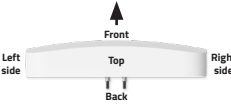

Elevation Plane  
"Side-on view"

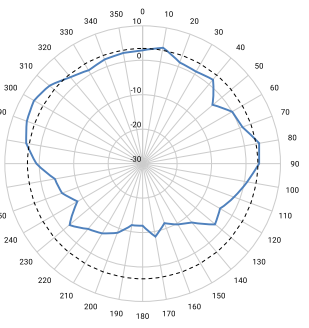
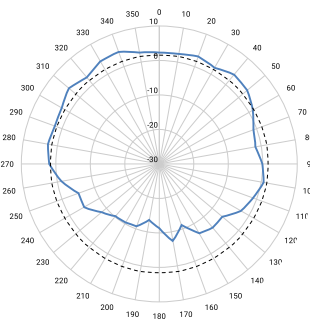
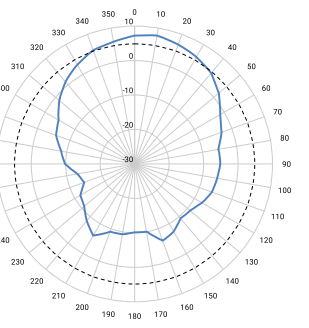
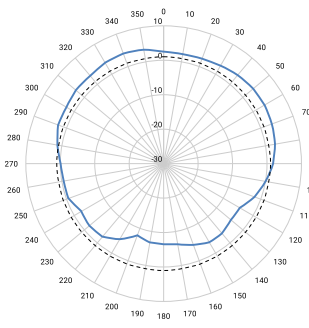
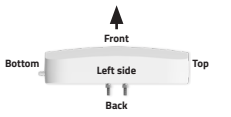

Antenna Peak Gain (dBi) by Frequency (Mhz)

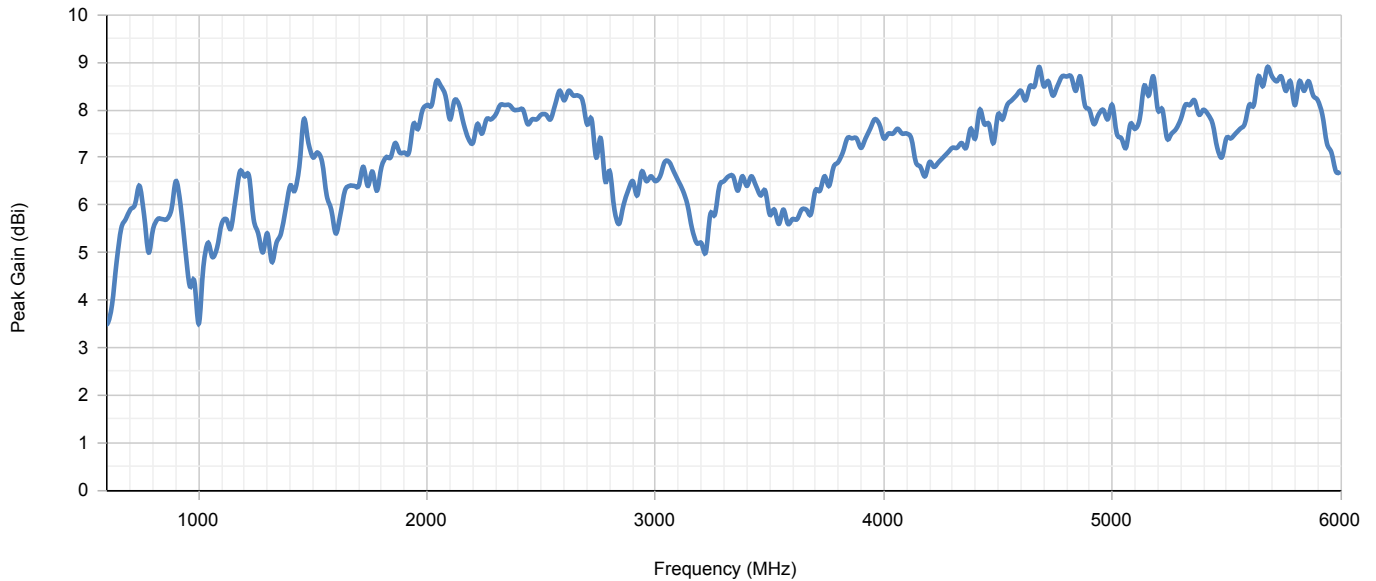

WAVEFORM

3411 W. Lake Center Drive,  
Santa Ana, CA 92704

www.waveform.com  
1-800-761-3041

# QuadPro

Directional 4x4 MIMO Panel Antenna

Designed by WAVEFORM in California

## Dimensions:

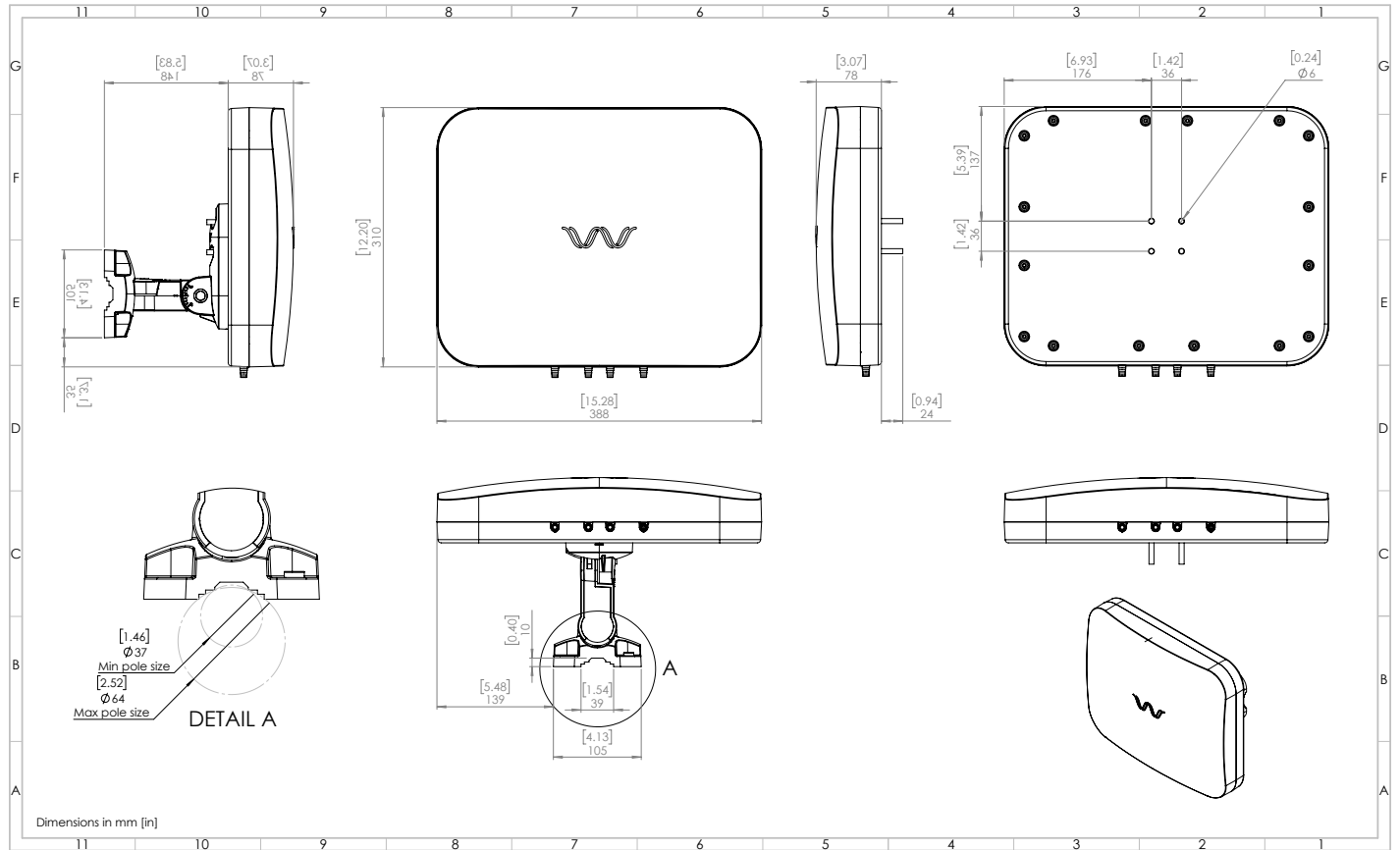

WAVEFORM

3411 W. Lake Center Drive,  
Santa Ana, CA 92704

www.waveform.com  
1-800-761-3041

# FlexMount

Designed by WAVEFORM in California

SKU: MNT-FM

## Features:

- 80° of horizontal and vertical articulation
- Integrated 16 AWG ground wire
- Includes equipment for vertical pole, horizontal pole, and wall installations.

A 1x FlexMount Bracket



Antenna Bracket

Mounting Bracket

B 2x U-Bolt Assemblies



C 4x Screws & Wall Anchors

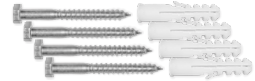

D 5x Velcro Ties



E 1x Size-5mm Allen Wrench



G 1x Size-10mm Socket Wrench



F 1x Size-17mm Combination Wrench



## Specifications:

### Mechanical (FlexMount):

FlexMount	Articulation	80° - horizontal 80° - vertical	
	Color	White (RAL 9003)	
	Material	PA6+30%GF	
	Dimensions (l x w x h)	14.8 x 10.5 x 16.0 cm (5.8 x 4.1 x 6.3 in)	
Integrated Grounding Cable	Cable	Color	Red
		Jacket	PVC
		Inner Conduct.	Tinned Stranded Copper
		Diam.	3.5 mm (0.14 in)
		Gauge	16 AWG
		Length	29.0 cm (11.4 in)
Conn.	Type	Ring Terminal	
	Material	Steel	
	Spec.	M6 & M10	
Locking Bolt	Material	316 stainless steel	
	Specification	Hex-Socket; M6 x 30 mm (1.2 in)	
Net Weight	0.4 kg (0.9 lbs)		

### Mechanical (Assembly):

U-Bolt	Material	316 stainless steel
	Dimensions (l x h x w)	M10; 75 x 135 x 60 mm (2.9 x 5.3 x 2.4 in)
	Supported Pole Diam.	64 mm (2.52 in) [Max] 37 mm (1.46 in) [Min]
Nut	Material	316 stainless steel
	Spec.	M10
Flat Washer	Material	316 stainless steel
	Spec.	M10
Lock Washer	Material	316 stainless steel
	Spec.	M10
Wall Screw	Material	5.8 grade steel
	Spec.	M10 x 60 mm (2.4 in)
Wall Anchor	Material	PA66
	Dimensions	50 x Ø 10.0 mm (2.0 x Ø 0.4 in)
Velcro Tie	Material	PP [Hooks], Nylon [Loops]
	Dimensions	150 mm (5.9 in)

### Electrical (Grounding Cable):

Voltage Rating (AC)	300 V
---------------------	-------

### Mechanical (Tools):

Combo. Wrench	Material	Drop forge steel
	Specification	Size-17mm
Allen Wrench	Material	Drop forge steel
	Specification	Size-5mm
Socket Wrench	Material	Drop forge steel
	Specification	Size-10mm

### Environmental:

FlexMount	Protection Class	IP44
	Impact Rating	IK08
	Rated Wind Velocity	200 kph (125 mph)
	UV Rated?	Yes
	Operating Temperature	-40 to +80 deg C (-40 to +176 deg F)
	UV Rated?	Yes
Integrated Grounding Cable	ROHS Rated?	Yes
	Operating Temperature	-20 to +80 deg C (-4 to +176 deg F)



WAVEFORM

3411 W. Lake Center Drive.,  
Santa Ana, CA 92704

www.waveform.com  
1-800-761-3041

# FlexMount

Designed by WAVEFORM in California

## Dimensions:

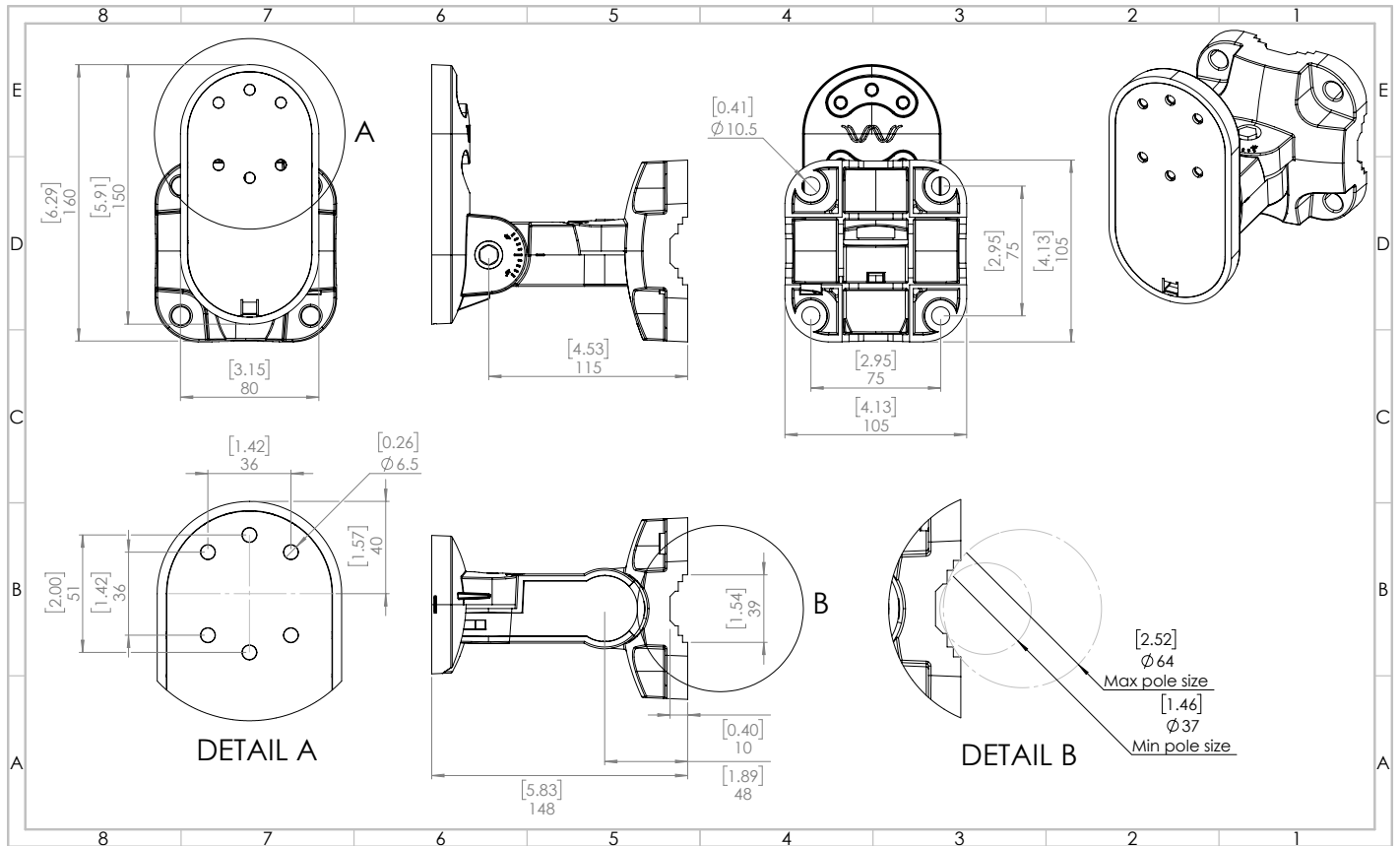

WAVEFORM

3411 W. Lake Center Drive.,  
Santa Ana, CA 92704

www.waveform.com  
1-800-761-3041

# UltraFlex-Quad

Designed by WAVEFORM in California

SKU: 195Q-SFM-xx

## Features:

- Four SMA-Female to SMA-Male ultraflex LMR195 cables grouped into one highly flexible cable.
- Integrated Weatherproof boots offer a fortified outdoor SMA connection.
- 0 MHz to 6000 MHz

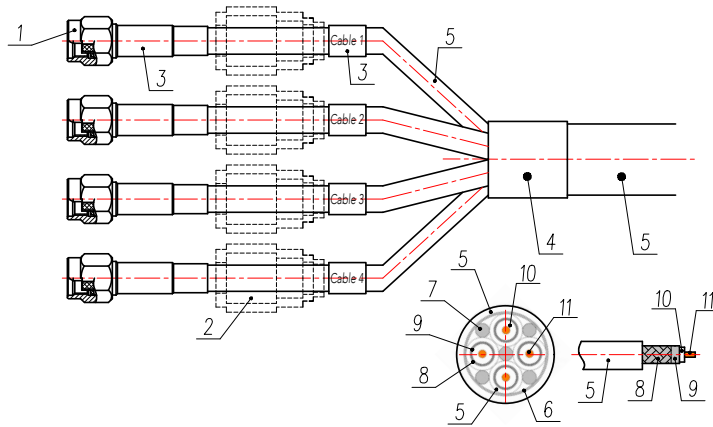
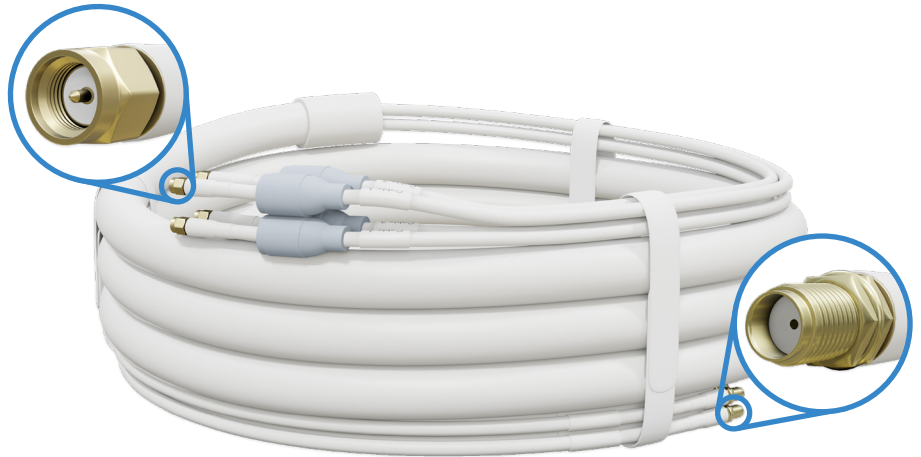

#	Description	Material
1	SMA Body	Gold-Plated Brass
2	Weatherproof Boot	Silicone Rubber
3	Heatshrink	PVC
4	Cable Molding	Solid TPE
5	Cable Jacket	TPE
6	Inter-cable Sheath	Clear PET
7	Inter-cable Filler	PP Lattice
8	Outer Conductor (#1)	Tinned Copper Braid
9	Outer Conductor (#2)	Bonded Aluminum Foil
10	Dielectric	PE Foam
11	Inner Conductor	Bare Copper

## Specifications:

Electrical:		RF Attenuation (per 10 ft):		Mechanical:		
Input Impedance	50 Ω	600 MHz	0.9 dB	Cable (Whole)	Jacket Color	White (RAL 9016)
Frequency Range	0 - 6000 MHz	900 MHz	1.1 dB		Type	LMR195
VSWR	≤ 1.5	1800 MHz	1.6 dB		Length	3.05 m (10 ft) 6.10 m (20 ft)
Capacitance	83.3 pF/m	2100 MHz	1.7 dB		Diameter	13.4 mm (0.53 in) [Group] 4.7 mm (0.19 in) [Indiv.]
Velocity	75 %	2500 MHz	1.9 dB	Bending Radius	130 mm (5.1 in) [Repeat] 65 mm (2.6 in) [Install]	
Shielding	> 90 dB	3000 MHz	2.1 dB		Male Cable End	Connector Type
Voltage	1000 V max (Working) 3000 V rms (Withstand)	4000 MHz	2.4 dB	Connector Diam.		7.9 mm (0.31 in)
	Contact Resist. (Cables)	≤ 24.9 Ω/km (Center) ≤ 16.1 Ω/km (Outer)	5000 MHz	2.8 dB		Cable Length
Contact Resist. (Connectors)	≤ 3.0 mΩ (Center) ≤ 2.5 mΩ (Outer)	6000 MHz	3.0 dB	Female Cable End	Connector Type	SMA-Female
	Insulation Resist.	≥ 1000 mΩ	<b>Environmental:</b> Protection Class IP66 (w/ Boots) Burial Rated? No UV Rated? Yes Operating Temperature -40 to +85 deg C (-40 to +185 deg F)		Connector Diam.	7.0 mm (0.28 in)
Power Rating	2.5 kW (Peak)	Net Weight			0.58 kg (1.28 lbs) [10 ft] 1.13 kg (2.50 lbs) [20 ft]	

# UltraFlex-Quad

Designed by WAVEFORM in California

## Dimensions:

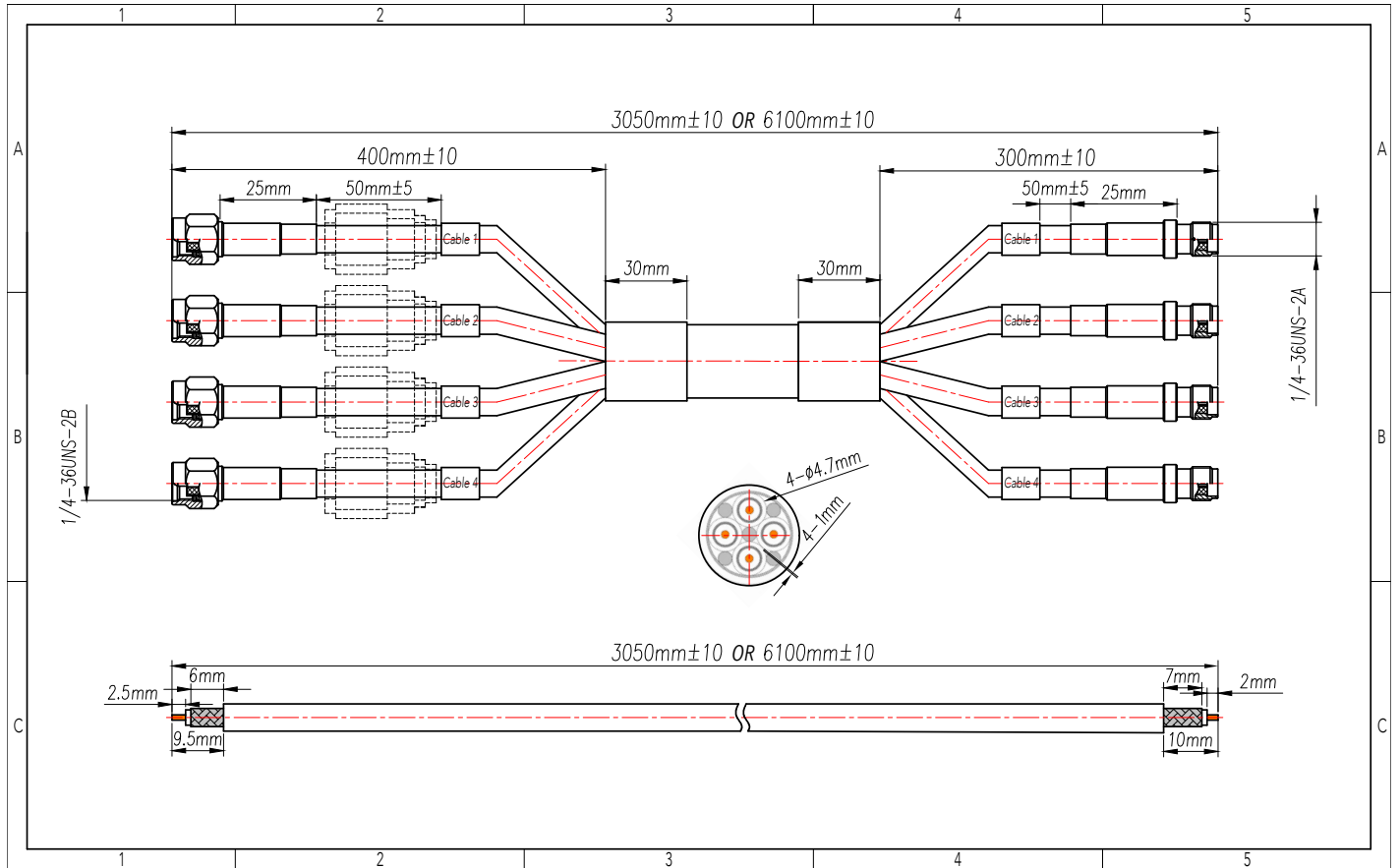

# Coax Window Entry Cable (Twin & Quad)

Designed by WAVEFORM in California

SKU: 113WP-SFM-x

## Features:

- Quad-cable or Twin-cable variants.
- Ultra-thin 300 mm (12 in) section for placement in a window.
- Adjustable cable directions
- 0 MHz to 6000 MHz

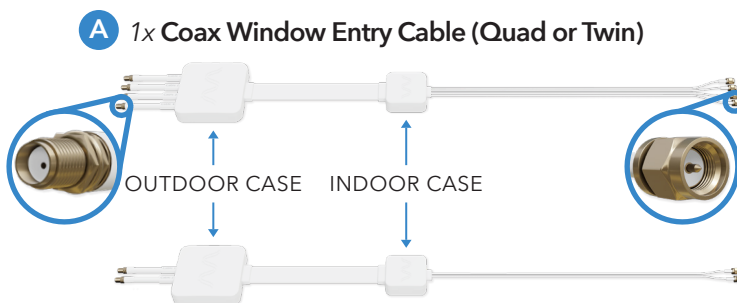

**B** 4x Wall Screws & Anchors

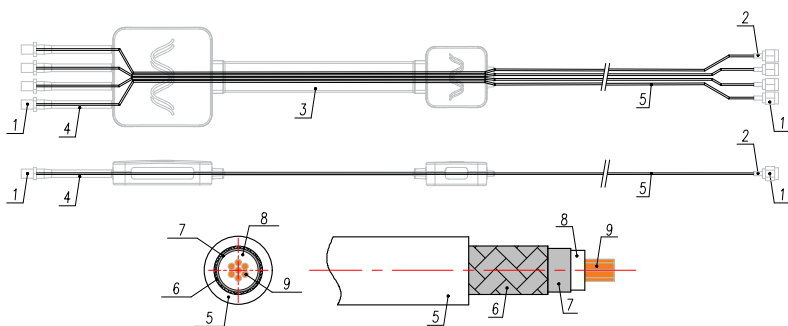
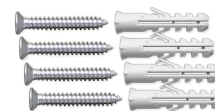

#	Description	Material
1	SMA-Bodies	Gold-Plated Copper
2	Heatshrink	PE & EVA
3	Cable Cover (Flat)	Silicone 70A
4	Cable Cover (Outdoor)	TPE
5	Cable Jacket (Indiv.)	FEP
6	Outer Conductor (#1)	Tinned Copper Braid
7	Outer Conductor (#2)	Bonded Aluminum Foil
8	Dielectric	FEP
9	Inner Conductor	Silver-Plated Copper

## Specifications:

### Electrical:

Input Impedance	50 Ω
Frequency Range	0 - 6000 MHz
VSWR	≤ 2.0
Capacitance	98.0 pF/m
Velocity	70 %
Shielding	> 100 dB
Voltage	300 V max (Working) 1500 V rms (Withstand)
Contact Resist. (Cables)	≤ 571 Ω/km (Center) ≤ 258 Ω/km (Outer)
Contact Resist. (Connectors)	≤ 3 mΩ (Center) ≤ 2 mΩ (Outer)
Insulation Resist.	≥ 5000 MΩ/km

### RF Attenuation:

600 MHz	0.84 dB
900 MHz	0.95 dB
1800 MHz	1.3 dB
2100 MHz	1.4 dB
2500 MHz	1.5 dB
3000 MHz	1.7 dB
4000 MHz	2.1 dB
5000 MHz	2.5 dB
6000 MHz	2.8 dB

### Mechanical (Cables):

Cable (Whole)	Jacket Color	White (P179-1C)
	Type	Low-loss RG1.13
	Length	60 cm (2 ft)
Outdoor Cables	Conn. Type	SMA-Female
	Conn. Diam.	7.0 mm (0.28 in)
	Cable Dimensions	50.0 x Ø 5.0 mm (2.0 x Ø 0.2 in)
Center Cable	Bending Radius	40.0 mm (1.6 in) [Repeat] 80.0 mm (3.1 in) [Install]
	Cable Dimensions	130 x 20 x 2.3 mm (5.1 x 0.8 x 0.09 in)
	Bending Radius	15.0 mm (0.6 in) [Repeat] 1.0 mm (0.04 in) [Install]
Indoor Cables	Conn. Type	SMA-Male
	Conn. Diam.	7.9 mm (0.31 in)
	Cable Dimensions	300 x Ø 1.2 mm (12 x Ø 0.05 in)
Net Weight	Bending Radius	8.0 mm (0.3 in) [Repeat] 6.0 mm (0.2 in) [Install]
		100 g (3.5 oz) [Quad] 80 g (2.8 oz) [Twin]

### Mechanical (Cases & Accessories):

Cases	Material	ASA
	Outdoor Case Dims.	65 x 65 x 15 mm (2.6 x 2.6 x 0.6 in)
	Indoor Case Dims.	40 x 40 x 15 mm (1.6 x 1.6 x 0.6 in)
Covers	Material	TPE
	Wall Screws	Material: 304 Stainless Steel Spec: Size-#7 x 2.54 cm (1.0 in)
Wall Anchors	Material	PP
	Dims.	30 x Ø 6.0 mm (1.2 x Ø 0.24 in)

### Environmental:

Protection Class	IP65
Impact Rating	IK05
Burial Rated?	No
UV Rated?	Yes
Operating Temperature	-40 to +80 deg C (-40 to 176 deg F)



WAVEFORM

3411 W. Lake Center Drive,  
Santa Ana, CA 92704

www.waveform.com  
1-800-761-3041



# Coax Window Entry Cable (Twin & Quad)

Designed by WAVEFORM in California

## Dimensions:

