

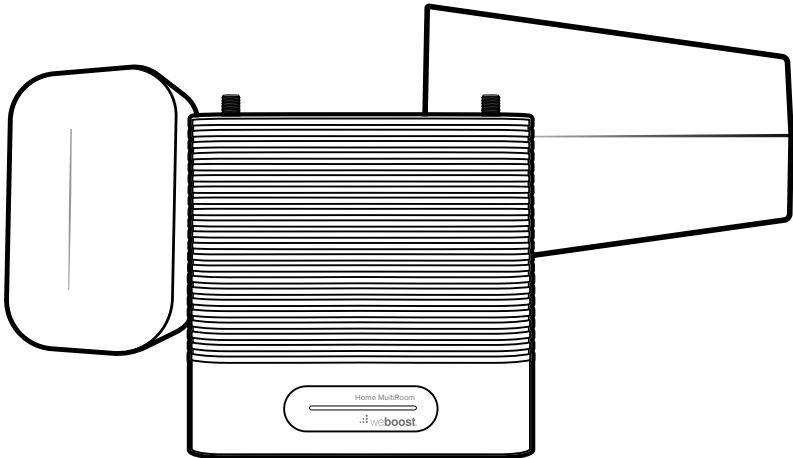



Home MultiRoom

Cell Signal Booster



Installation Guide

Use our  **weBoost App** to guide you through the installation.
See inside page for more details.

NEED HELP?



support.weboost.com



1-866-294-1660



Download the weBoost App

Use our app to guide you through setting up a weBoost cell phone signal booster in your home, business, or vehicle. Boost every network, including 5G, right away.



Index

Package Contents	1
Preparation	2
STEP 1: Inside Antenna & Booster Placement	3
STEP 2: Mount & Point Outside Antenna Toward Nearest Cell Tower	5
STEP 3: Route & Connect Outside Antenna To Booster	8
STEP 4: Route & Connect Inside Antenna To Booster	9
STEP 5: Power Up The Booster & Optimize The System	10
Measuring Booster Performance	12
Light Patterns	14
Troubleshooting	15
Safety Guidelines	17
Specifications	18
Warranty	19

Package Contents



Home
MultiRoom

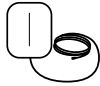

Inside
Antenna
(314440)

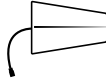

Outside
Antenna
(314445)



30' & 2-15'
Cables (950630),
(YX030-15W w/971129
Barrel Connector)



Power
Supply
(850018)



Window Entry
Cable
(951177)



Outside Antenna
Mounting Bracket



Wall Mount Brackets
w/Command Strips



Cable Mounting
Clips Qty. 15

Preparation

You Will Need (tools not included)

Make sure the following materials are prepared and ready for your installation.



1 to 2 hours



1 Person (2 people to make antenna calibration easier)



- Ladder
- Drill (*if routing cable through wall*)
- 1"-3" diameter existing pole for mounting
Outside Antenna (#901117 Pole Mount can be purchased separately if needed)
- Recommended: Power Strip with surge protection

NOTE: These instructions will walk you through a “soft” install process to find the optimal locations for the inside and outside antennas, then through the process of the permanent installation.

Step 1: Inside Antenna & Booster Placement

Place the **inside antenna** where you need the greatest signal boost and place **booster** in your desired location at least **24"** away from inside antenna.

NOTE: Do not connect booster to power until the system is fully installed.

TIP: The cable from the inside antenna can be routed into the ceiling and connected to the coax cable out-of-sight for a better look.

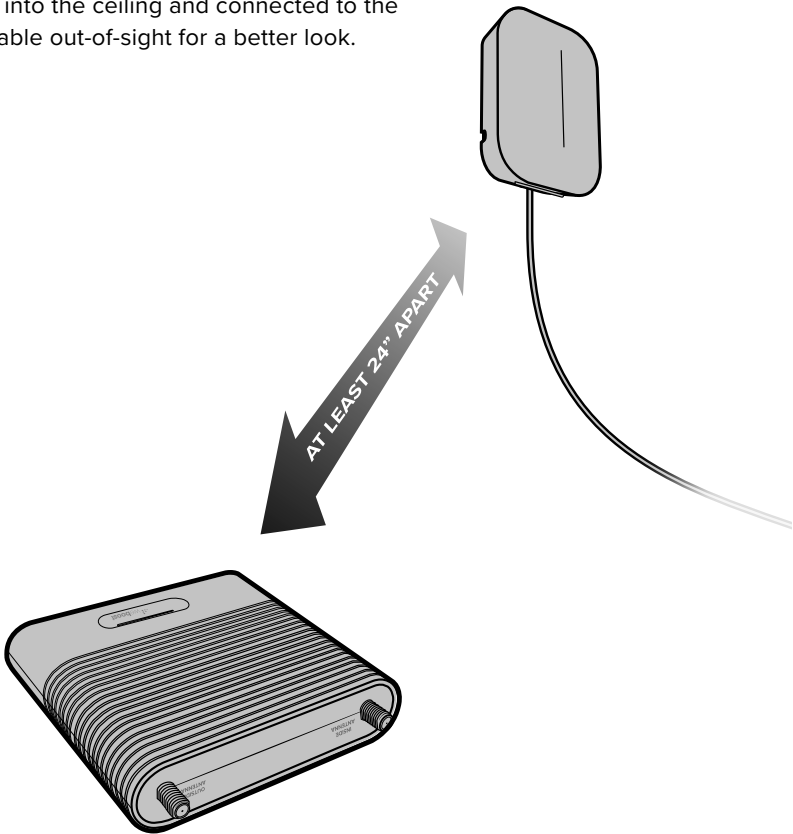

(STEP 1 cont.)

The inside antenna can be mounted horizontal, vertical or on a desktop. Command strips can be used to secure mounting bracket.

Inside Antenna Mounting Options

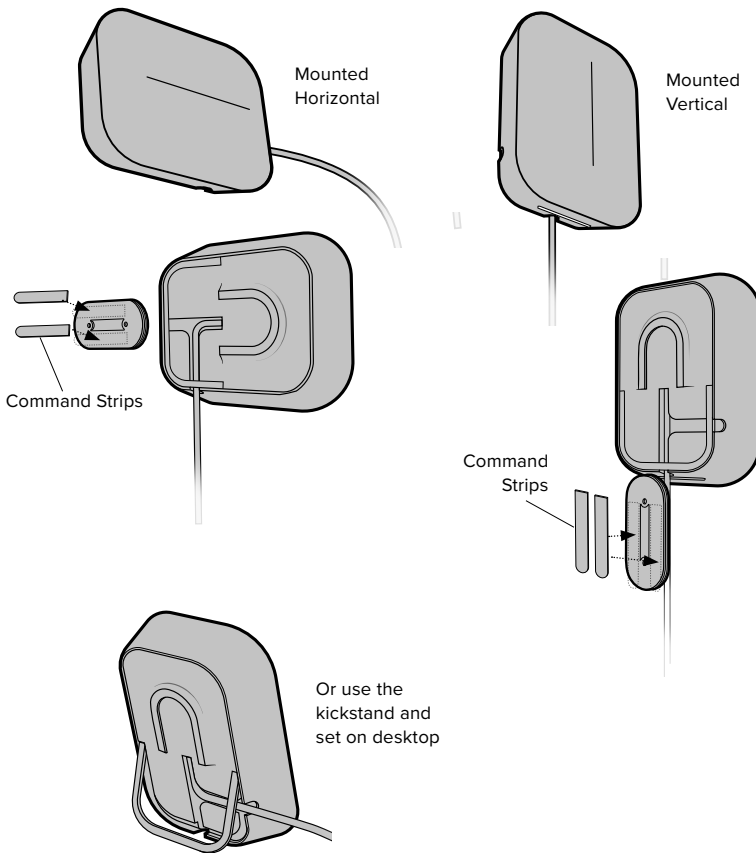

Step 2: Mount & Point Outside Antenna Toward Nearest Cell Tower

Pole mounting and wall mounting options are included. The pole mounting option is preferred because it will be easier to adjust to the direction of the cell tower.

Attach the **mount** to the outside antenna and use the **bracket clamps** to attach the antenna to a pole or exhaust pipe.

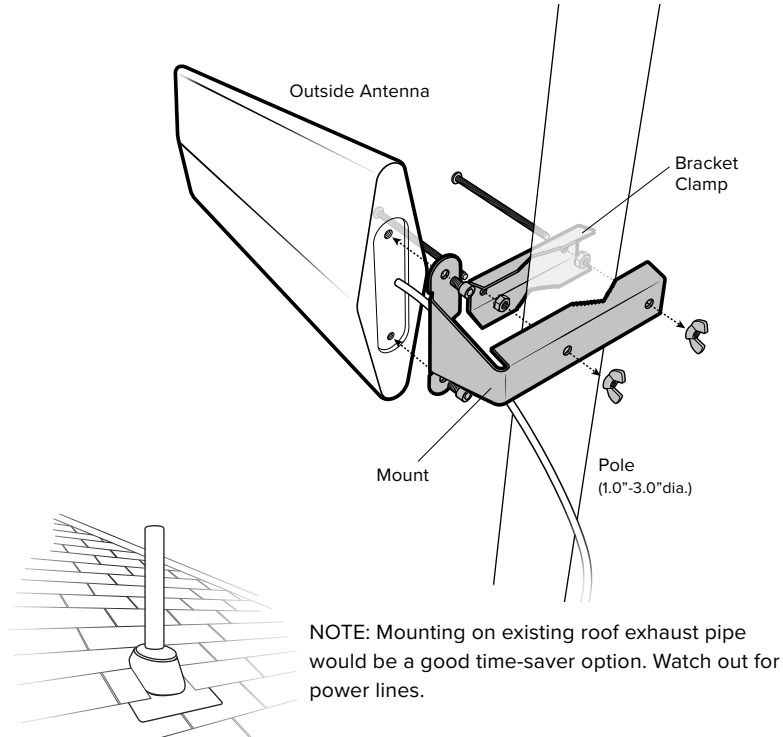

(STEP 2 cont.)

Point the **outside antenna** toward the nearest cell phone tower. To find the nearest tower, use the weBoost app. **This is the most critical step of the installation process because it will determine the overall performance of the booster system.**

The greater the separation between the inside and outside antennas, the better performance you will get from the booster.

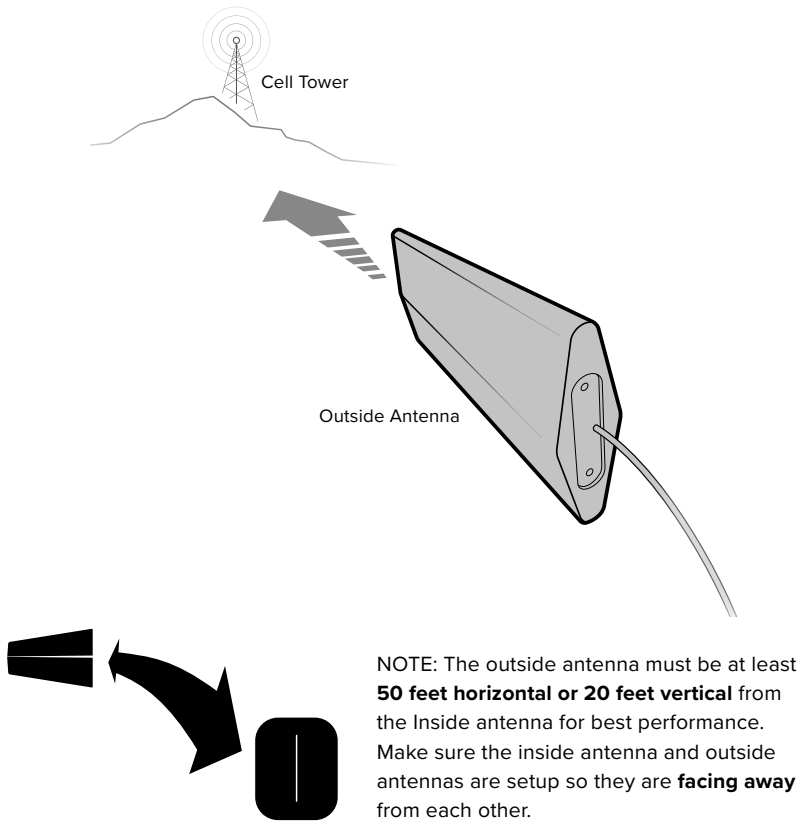

(STEP 2 cont.)

If there's not a pole to easily mount the outside antenna, this may be mounted on the fascia by fastening the bracket as shown below.

TIP: Make sure to do the optimization test on Step 4 to find the best side of your house before you mount this on the fascia.

Mounting On Side Of Roof (Fascia)

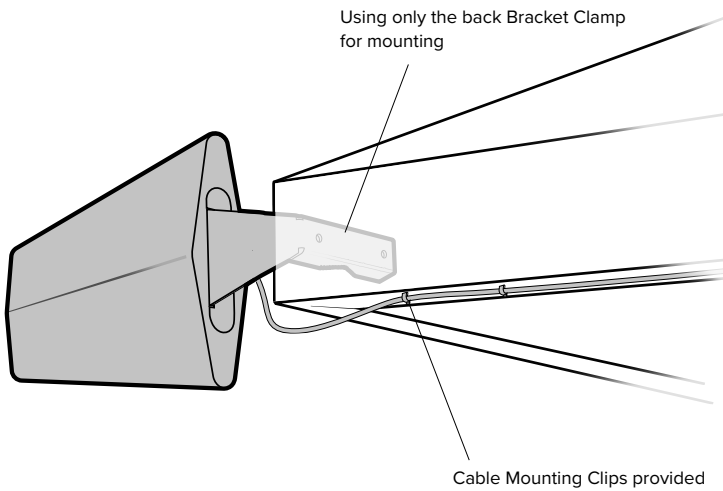

Step 3: Route & Connect Outside Antenna To Booster

Connect the white **RG-6 Cable** to **outside antenna** and route cable into the home. A window entry cable is provided to help make cable entry easier. All connections should be **finger tightened** only.

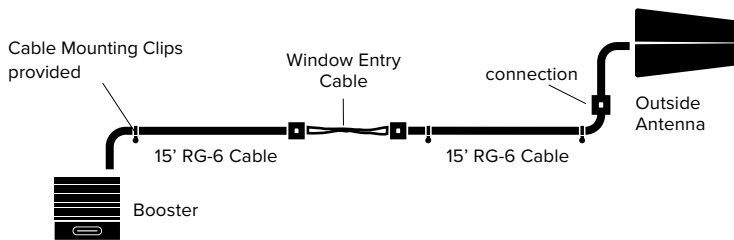

Route cable to the **Home MultiRoom booster** and connect to the port labeled 'OUTSIDE ANTENNA'.

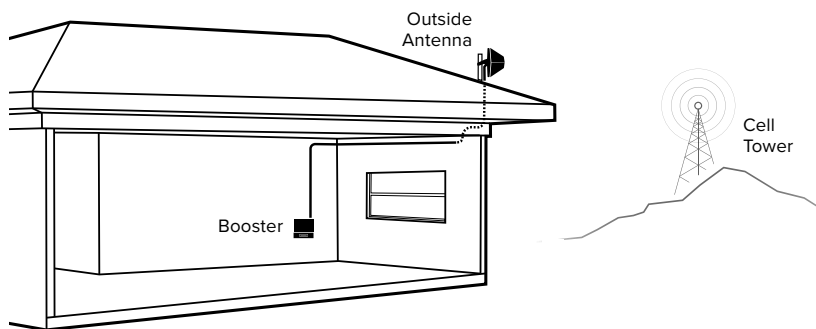

Step 4: Route & Connect Inside Antenna To Booster

Connect the white **30'** cable to inside antenna and route to the **Home MultiRoom booster** and connect to the port labeled 'INSIDE ANTENNA'.

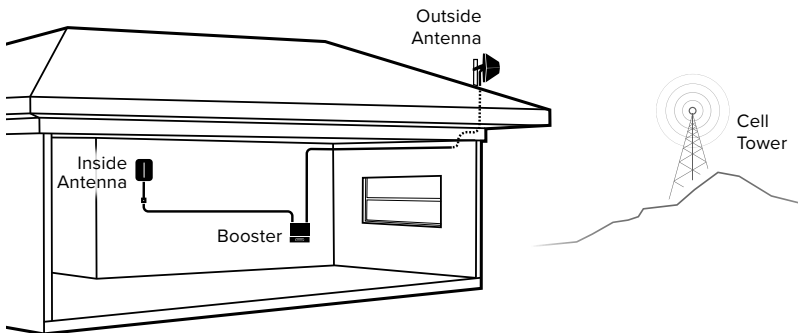
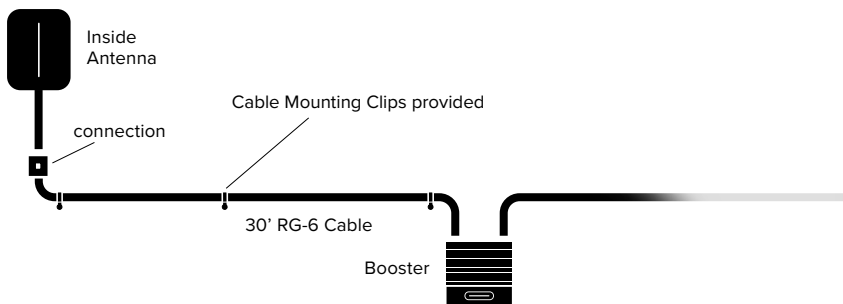

Step 5: Power Up The Booster & Optimize The System

Plug the **power supply** into wall outlet then connect to end of booster labeled “” (turn 90° to lock connector).

NOTE: We strongly recommend using a power strip with surge protection.

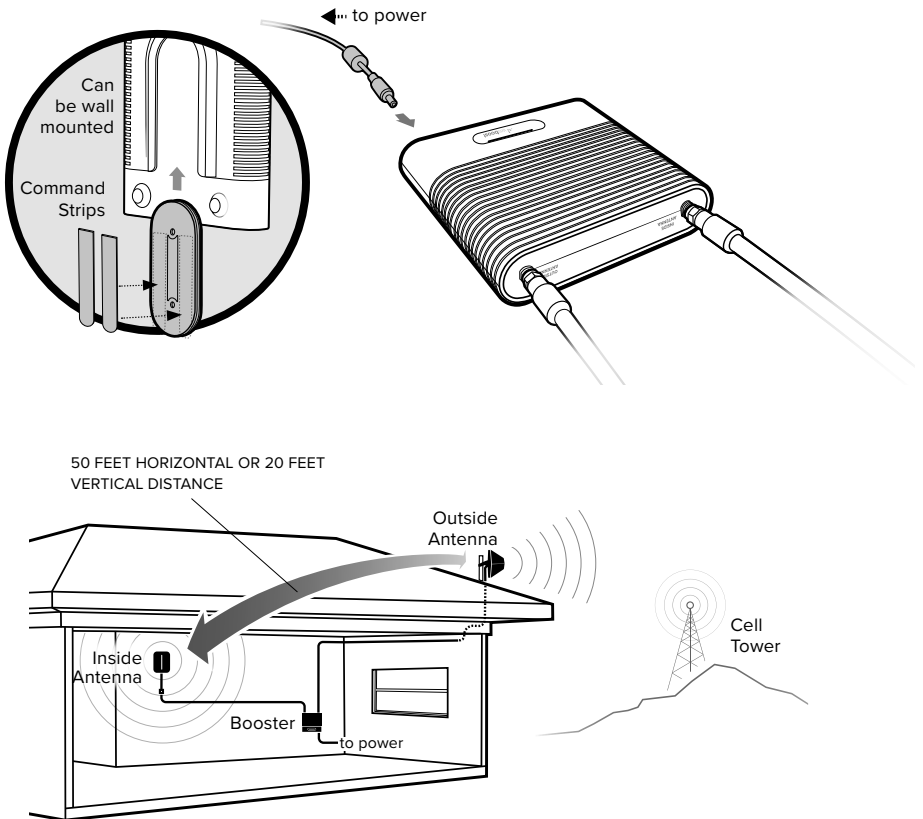

(STEP 5 cont.)

OPTIONAL: After powering up your system, you can optimize your system to see if more performance is possible. Rotate the outside antenna in 1/3 turn increments, **after each turn, unplug and reconnect the booster to power while observing the signal level on your cell phone from the inside antenna's projected area.** Secure the outside antenna in place, pointing in the direction that gives you the strongest signal. Enjoy your boosted signal!

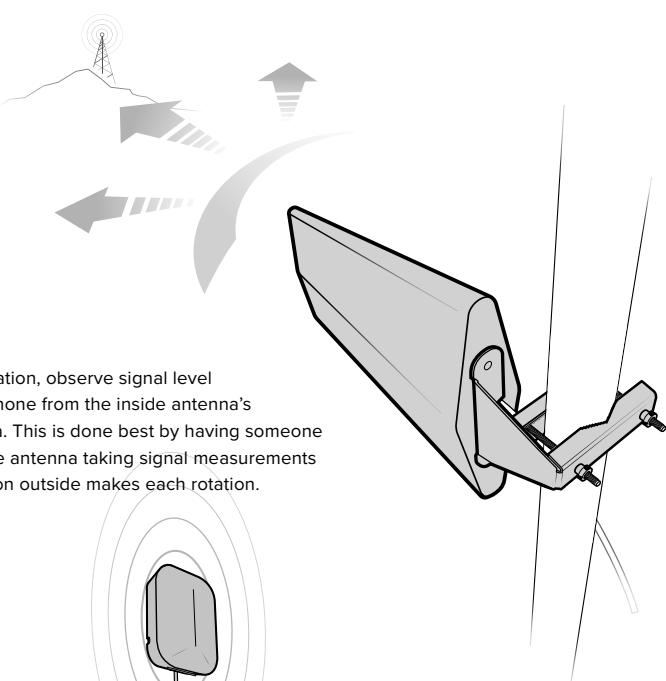

After each rotation, observe signal level on your cell phone from the inside antenna's projected area. This is done best by having someone near the inside antenna taking signal measurements after the person outside makes each rotation.

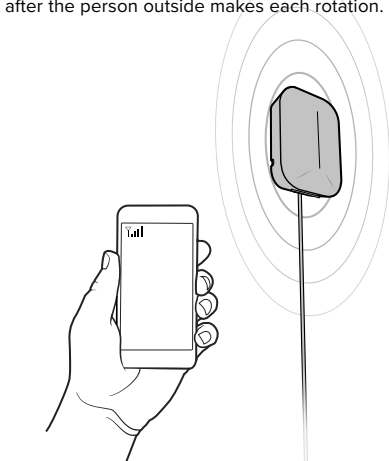

Measuring Booster Performance

How To Get Signal Strength As A Number

iPhone®

iOS 11 and later no longer displays the decibel (dBm) reading in 'Field Test Mode'. Tip: Using the dot signal strength indicator on your cell phone can assist you in finding the strongest signal direction as well as placing calls in different locations.

For changes/updates on this issue, periodically go to weboost.com/signalstrength.

Android™

Settings > About Phone > Status or Network > Signal Strength or Network Type and Strength (exact options/wording depends on phone model).

iPhone is a registered trademark of Apple Inc. Android is a trademark of Google Inc.

All Other Phones & Alternate Methods

Go to www.weboost.com/test-mode-instructions/

(MEASURING BOOSTER PERFORMANCE cont.)

Signal Strength without Booster

Note here: _____

Signal Strength with Booster

Note here: _____

Compare Results

Having an accurate measurement of signal strength in decibels (dBm) is crucial when installing your system. Decibels accurately measure the signal strength you are receiving.

SIGNAL STRENGTH	EXCELLENT	GOOD	FAIR	POOR	DEAD ZONE
3G/1x	-70dBm	-71 to -85dBm	-86 to -100dBm	-101 to -109dBm	-110dBm
4G/LTE	-90dBm	-91 to -105dBm	-106 to -110dBm	-111 to -119dBm	-120dBm

DID YOU KNOW a signal increase of just 3dB is 2 times the power and signal amplification!

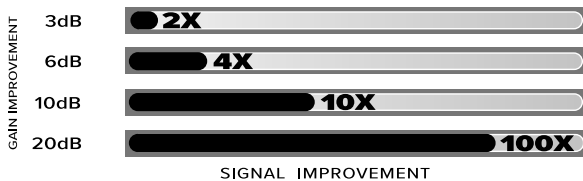

Light Patterns

Solid Green

This indicates that your booster is functioning properly and there are no issues with installation.

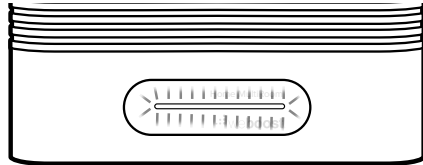

Blinking Green & Red

Band has reduced gain. This indicates that one or more of the booster bands has reduced power due to a feedback loop condition called oscillation. This is a built in safety feature to prevent harmful interference with a nearby cell tower. If you are already experiencing the desired signal boost, then no further adjustments are necessary. If you are not experiencing the desired boost in coverage then refer to the Troubleshooting section.

Solid Red

Band has shutoff. This is due to a feedback loop condition called oscillation. This is a built in safety feature that causes a band to shut off to prevent harmful interference with a nearby cell tower. Refer to Troubleshooting section.

Blinking Green & Yellow

Band has reduced gain. This indicates that one or more of the booster bands has reduced power due to overload from nearby cell tower. This is a built in safety feature to prevent harmful interference with a nearby cell tower. If you are already experiencing the desired signal boost, then no further adjustments are necessary. If you are not experiencing the desired boost in coverage then refer to the Troubleshooting section.

Solid Yellow

Band has shutoff due to overload from nearby cell tower. Outside Antenna must be adjusted. Refer to Troubleshooting section.

Light Off

If the Signal Booster's light is off, verify your power supply has power.

Troubleshooting

IF YOU ARE HAPPY WITH THE COVERAGE, THESE LIGHT ISSUES DON'T HAVE TO BE RESOLVED. YOUR CARRIER'S BAND HAS NOT BEEN AFFECTED.

FIXING ANY RED LIGHT ISSUES

This involves Solid Red & Blinking Green/Red lights.

- 1 Verify outside and inside antenna face away from each other. Un-plug and re-plug in power supply.
- 2 Verify the inside antenna is at least 24" from the booster and pointed away from the booster. Unplug and re-plug in power supply.
- 3 Tighten all cable connections (be sure to finger tighten only, do NOT use tools). You may want to undo and redo the connection completely. Unplug and re-plug in power supply.
- 4 Increase the distance (horizontally or vertically) between the outside and inside antenna. Add included cable if needed. Un-plug and re-plug in power supply.

FIXING ANY YELLOW LIGHT ISSUES

This involves Solid Yellow & Blinking Green/Yellow lights.

Outside Antenna must be adjusted. Wait 10 seconds between adjustments for the lights to reset.

Pole Mount Option: Rotate the outside antenna away from the strongest cellular signal in small increments (1/3) until the light turns green. Unplug and re-plug in power supply.

Mounting On Side Of Roof Option: Change mount location. Move the outside antenna to location of the home/building to see if the lights turn green. Un-plug and re-plug in power supply. Then secure in place.

NEED HELP?



support.weboost.com



1-866-294-1660

Antenna Kit Options

The following accessories are certified by the FCC to be used with the Home MultiRoom.

This radio transmitter 4726A-460059 has been approved by Innovation, Science and Economic Development Canada to operate with the antenna types listed below, with the maximum permissible gain indicated. Antenna types not included in this list that have a gain greater than the maximum gain indicated for any type listed are strictly prohibited for use with this device.

	BAND 12/17	BAND 13	BAND 5	BAND 4	BAND 25/2
Outside antenna maximum permissible antenna gain (dBi) 50Ω	4.9	4.9	4.5	4.6	4.2
Inside antenna maximum permissible antenna gain (dBi) 50Ω	3.2	3.2	3.2	2.6	2.7

FIXED INSIDE ANTENNA KIT OPTIONS

Kit #	Coax Type	Ln(ft)	Antenna Type	Ω
301211	RG-6	30	Desktop	75
304419	RG-6	30	Dome	75
314440	RG-6	30	Panel	75

FIXED OUTSIDE ANTENNA KIT OPTIONS

Kit #	Coax Type	Ln(ft)	Antenna Type	Ω
314445	RG-6	30	Directional	75
314475	RG-6	30	Directional	75
304423	RG-6	30	Omni	75
304421	RG-6	30	Omni	75

Safety Guidelines

To uphold compliance with network protection standards, all active cellular devices must maintain at least six feet of separation distance from inside panel and dome antennas and at least four feet of separation distance from desktop antenna.

Use only the power supply provided in this package. Use of a non-weBoost product may damage your equipment.

The signal booster unit is designed for use in an indoor, temperature-controlled environment (less than 100 degrees Fahrenheit). It is not intended for use in attics or similar locations subject to temperatures in excess of that range.

RF Safety Warning: Any antenna used with this device must be located at least 8 inches from all persons.

AWS Warning: The outside antenna must be installed no higher than 10 meters (31'9") above ground.

This is a CONSUMER device.

BEFORE USE, you **MUST REGISTER THIS DEVICE** with your wireless provider and have your provider's consent. Most wireless providers consent to the use of signal boosters. Some providers may not consent to the use of this device on their network. If you are unsure, contact your provider.

In Canada, **BEFORE USE** you must meet all requirements set out in ISED CPC-2-1-05.

You **MUST** operate this device with approved antennas and cables as specified by the manufacturer. Antennas **MUST** be installed at least 20 cm (8 inches) from (i.e., **MUST NOT** be installed within 20 cm of) any person.

You **MUST** cease operating this device immediately if requested by the FCC (or ISED in Canada) or licensed wireless service provider.

WARNING. E911 location information may not be provided or may be inaccurate for calls served by using this device.

This device may be operated **ONLY** in a fixed location for in-building use.

FOR MORE INFORMATION ON REQUIREMENTS SET OUT IN ISED CPC-2-1-05, SEE BELOW:

<http://www.ic.gc.ca/eic/site/smt-gst.nsf/eng/sf08942.html>

FOR MORE INFORMATION ON REGISTERING YOUR SIGNAL BOOSTER WITH YOUR WIRELESS PROVIDER, PLEASE SEE BELOW:

T-Mobile/Sprint/MetroPCS: <https://www.t-mobile.com/support/coverage/register-a-signal-booster>

Verizon Wireless: <http://www.verizonwireless.com/wcms/consumer/register-signal-booster.html>

AT&T: <https://securec45.securewebsession.com/attsignalbooster.com/>

U.S. Cellular: <http://www.uscellular.com/uscellular/support/fcc-booster-registration.jsp>

Specifications

Home MultiRoom™					
Product Number	U470059				
Model Number	460059				
FCC ID	PWO460059				
IC ID	4726A-460059				
Connectors	F-Female				
Antenna Impedance	75 Ohms				
Frequency	698-716 MHz, 729-746 MHz, 746-757 MHz, 776-787 MHz, 824-849 MHz, 869-894 MHz, 1710-1755 MHz, 1850-1915 MHz, 1930-1995 MHz, 2110-2155 MHz				
Power output for single cell phone (Uplink) dBm AWGN	700 MHz Band 12/17	700 MHz Band 13	800 MHz Band 5	1700 MHz Band 4	1900 MHz Band 25/2
	21.7	21.9	23.4	22.7	21.9
Power output for single cell phone (Downlink) dBm AWGN	700 MHz Band 12/17	700 MHz Band 13	800 MHz Band 5	2100 MHz Band 4	1900 MHz Band 25/2
	12.2	12.3	12.6	12.5	12.5
Power output for single cell phone (Uplink) dBm GSM	700 MHz Band 12/17	700 MHz Band 13	800 MHz Band 5	2100 MHz Band 4	1900 MHz Band 25/2
	24.8	25.0	25.3	25.2	25.1
Power output for single cell phone (Downlink) dBm GSM	700 MHz Band 12/17	700 MHz Band 13	800 MHz Band 5	2100 MHz Band 4	1900 MHz Band 25/2
	12.7	12.2	12.8	12.6	12.8
Noise Figure	5 dB nominal				
Isolation	> 110 dB				
Power Requirements	4.2 VDC				

Each Signal Booster is individually tested and factory set to ensure FCC compliance. The Signal Booster cannot be adjusted without factory reprogramming or disabling the hardware. The Signal Booster will amplify, but not alter incoming and outgoing signals in order to increase coverage of authorized frequency bands only. If the Signal Booster is not in use for five minutes, it will reduce gain until a signal is detected. If a detected signal is too high in a frequency band, or if the Signal Booster detects an oscillation, the Signal Booster will automatically turn the power off on that band. For a detected oscillation the Signal Booster will automatically resume normal operation after a minimum of 1 minute. After 5 (five) such automatic restarts, any problematic bands are permanently shut off until the Signal Booster has been manually restarted by momentarily removing power from the Signal Booster. Noise power, gain, and linearity are maintained by the Signal Booster's microprocessor.

The term "IC" before the radio certification number only signifies that Industry Canada technical specifications were met. This device complies with Part 15 of FCC rules. This device contains licence-exempt transmitter(s)/receiver(s) that comply with Innovation, Science and Economic Development Canada's licence-exempt RSS(s). Operation is subject to the following two conditions: (1) This device may not cause interference, and (2) This device must accept any interference, including interference that may cause undesired operation of the device. Changes or modifications not expressly approved by weBoost could void the authority to operate this equipment.

NEED HELP?



support.weboost.com



1-866-294-1660



2 YEAR WARRANTY

weBoost Signal Boosters are warranted for two (2) years against defects in workmanship and/or materials. Warranty cases may be resolved by returning the product directly to the reseller with a dated proof of purchase.

Signal Boosters may also be returned directly to the manufacturer at the consumer's expense, with a dated proof of purchase and a Returned Material Authorization (RMA) number supplied by weBoost. weBoost shall, at its option, either repair or replace the product.

This warranty does not apply to any Signal Boosters determined by weBoost to have been subjected to misuse, abuse, neglect, or mishandling that alters or damages physical or electronic properties.

Replacement products may include refurbished weBoost products that have been recertified to conform with product specifications.

RMA numbers may be obtained by contacting Customer Support

DISCLAIMER: The information provided by weBoost is believed to be complete and accurate. However, no responsibility is assumed by weBoost for any business or personal losses arising from its use, or for any infringements of patents or other rights of third parties that may result from its use.



3301 East Deseret Drive, St. George, UT

 1.866.294.1660  www.weboost.com  support.weboost.com

Copyright © 2019 weBoost. All rights reserved.
weBoost products covered by U.S. patent(s) and pending application(s)
For patents go to: weboost.com/us/patents