

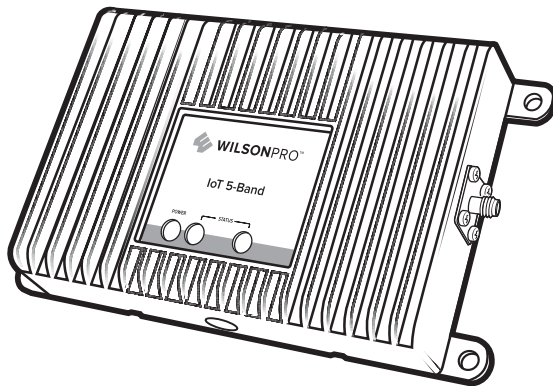

Installation Guide



IoT 5-Band Direct-Connect Cell Signal Amplifier

Index

Package Contents	2
IoT Retail Application Steps	3-6
IoT Security Application Steps	7-10
Status Light Patterns	11
Safety Guidelines	12
Specifications	16
Warranty	17

IoT 5-Band

Direct-Connect Cell Signal Amplifier

The WilsonPro IoT 5-Band is a “Direct-Connect” solution for amplifying cellular network capable equipment and devices, including vending machines, ATMs, security panels, and cellular “hotspots”. The IoT 5-Band is “carrier agnostic” and pre-approved by all major cell carriers under FCC “part 20” rules. No additional carrier or FCC approvals are required.

The IoT 5-band is available in three different kit options: 460119: basic kit with traditional a/c power supply, 460219: with “hard-wired” DC power supply (for supplying power from a vehicle or similar power source), and the 461119 Security Kit which includes MMCX cables for interfacing with security control panel cell modems, and an outside antenna.

Package Contents



+

Any Kit Option
Below

IoT 5-Band
Cell Signal Amplifier
(460019)

Kit Options (IoT 5-Band Cell Signal Amplifier included)

IoT 5-Band Kit 460119

- 6 ft. RG-174 w/SMA
- 5V / 4A A/C Power Supply
- 4 in. Mini Magnetic Antenna

IoT DC Hardwire Kit 460219

- 6 ft. RG-174 w/SMA
- 6V / 2A Hardwired Power Supply
- 4 in. Mini Magnetic Antenna

IoT Security Kit 461119

- 12 in. RG-316 w/MMcx
- 12 in. Adapter w/MMcx
- 10ft. RG-58 w/SMA
- 30ft. RG-58 w/SMA
- 5V / 4A A/C Power Supply
- Omni Antenna

IoT Retail Application Example

STEP 1 Outside Antenna Placement

Mount the Outside Antenna on top of a metal structure that is free of obstructions and 12 in. away from any other antennas.

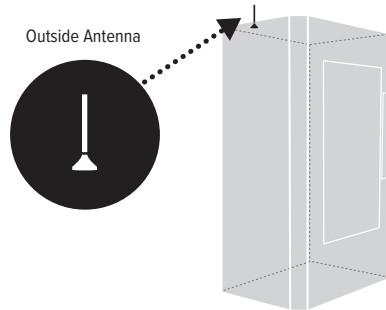

STEP 2 Amplifier Placement

Select a location to install the Signal Amplifier that is away from excessive heat, direct sunlight, moisture and that has proper ventilation.

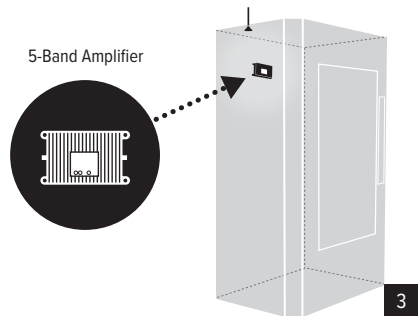

STEP 3 Route & Connect Antenna to Amplifier

Run the Outside Antenna Cable to the Signal Amplifier and attach it to the connector labeled Outside Antenna. Finger tighten only.

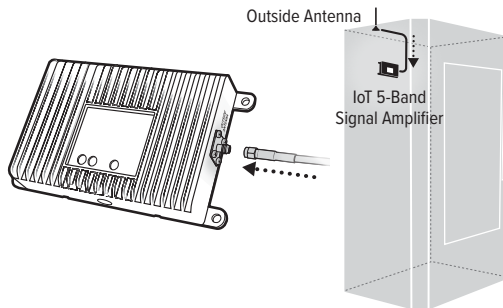

STEP 4 Connect Device to Amplifier

Connect the provided cable to the cellular device (adapter may be needed) then to the connector labeled Data Device on the Signal Amplifier. Finger tighten only.

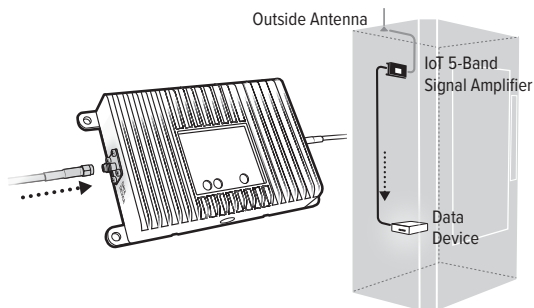

STEP 5 Power Up the Amplifier

Plug the Power Supply into an outlet (or connect to hardwired 12V DC source if kit 460219 is used) then connect to end of amplifier labeled POWER.

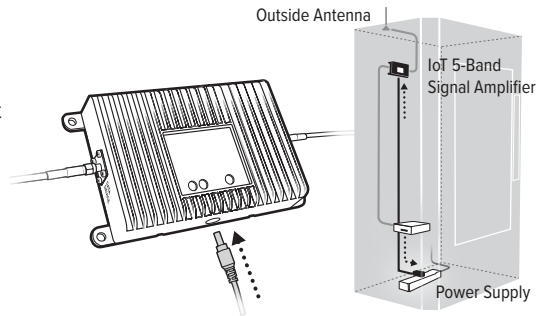

Important

- If the amplifier loses power, internal circuitry will bypass the amplifier switch so that a connection is made directly to the antenna.
- Safeguard your devices. Using a surge protector is always recommended for these applications.

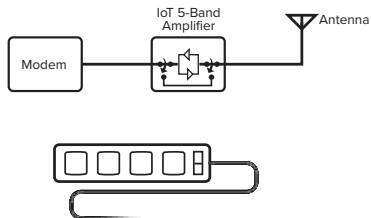

Diagram

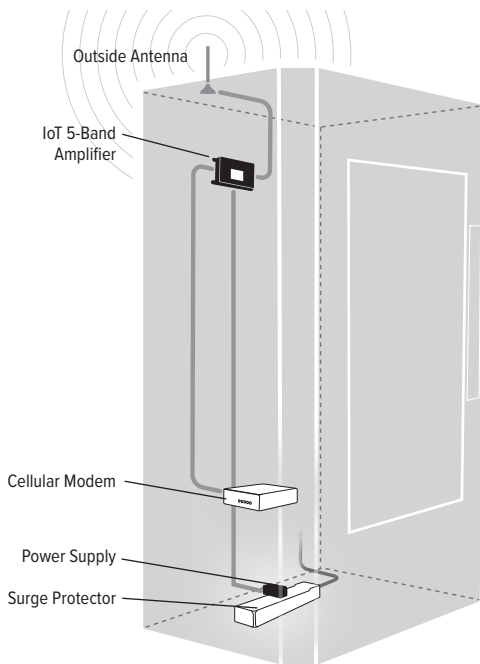

IoT Security Application Example

STEP 1 Outside Antenna Placement

Mount the Outside Antenna on top of a metal structure that is free of obstructions and 12 in. away from any other antennas.

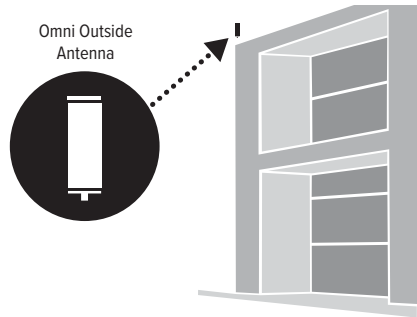

STEP 2 Amplifier Placement

Select a location to install the Signal Amplifier that is away from excessive heat, direct sunlight, moisture and that has proper ventilation.

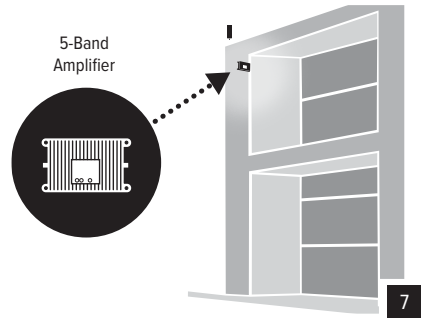

STEP 3 Route & Connect Antenna to Amplifier

When using the Omni Outside Antenna, connect the N-Type connector to the antenna, then the SMA end to the amplifier. Finger tighten only.

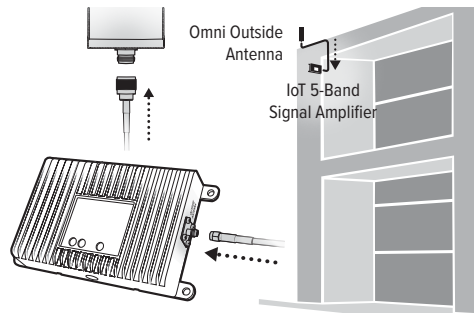

STEP 4 Connect Device to Amplifier

Connect the provided MMCX cable to the Security Control Panel (adapter may be needed) then to the connector labeled Data Device on the Signal Amplifier.

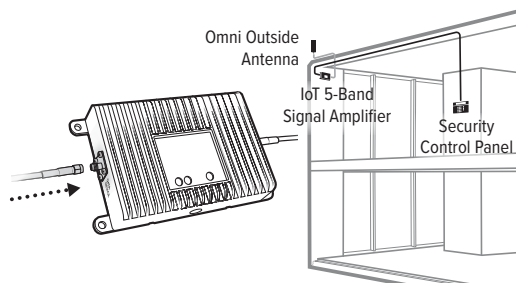

STEP 5 Power Up the Amplifier

Connect the provided cable to the Security Control Panel (adapter may be needed) then to the connector labeled Data Device on the Signal Amplifier.

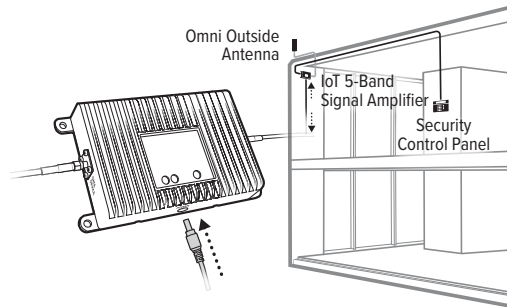

Important

- If the amplifier loses power, internal circuitry will bypass the amplifier switch so that a connection is made directly to the antenna.
- Safeguard your devices. Using a surge protector is always recommended for these applications.

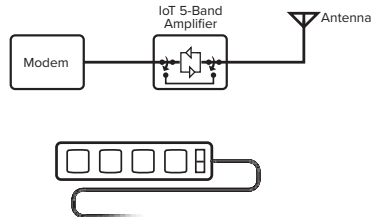

Diagram

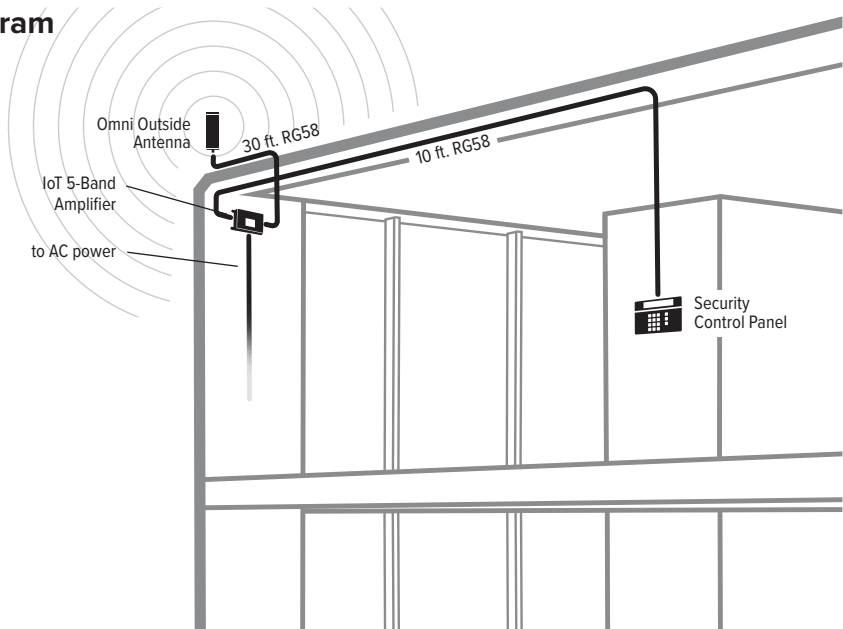

Status Light Patterns

GREEN

This indicates that your amplifier is functioning properly and there are no issues with installation.

SOLID RED

Band has shutoff. This is due to a feedback loop condition called oscillation. This is a built in safety feature that causes a band to shut off to prevent harmful interference with a nearby cell tower. Refer to Troubleshooting section.

BLINKING GREEN, RED

This indicates that the amplifier is operating at a reduced gain to prevent oscillation (feedback).

LIGHTS OFF

If the Signal Amplifier's light is off, verify your power supply has power.

Troubleshooting

FIXING RED LIGHT ISSUES

This involves Solid Red & Blinking Green/Red lights.

- Make sure all connections are tight. Un-plug and re-plug in power supply.
- Increase the distance (horizontally or vertically) between the Outside Antenna and the amplifier. Un-plug and re-plug in power supply.

LIGHTS OFF

- Check connections on the power supply to see that it is firmly plugged into both the amplifier and the power source.

 866.294.1660

 www.wilsoselectronics.com

 support@wilsoselectronics.com

Safety Guidelines

Verify that both the Outside Antenna and the adapter extension cable are connected to the Signal Amplifier before powering up the Signal Amplifier.

Use only the power supply provided in this package. Use of a non-Wilson Electronics products may damage your equipment.

RF Safety Warning: Any antenna used with this device must be located at least 8 inches from all persons.

AWS Warning: The Outside Antenna must be installed no higher than 10 meters (31'9") above ground

This is a **CONSUMER** device.

BEFORE USE, you **MUST REGISTER THIS DEVICE** with your wireless provider and have your provider's consent. Most wireless providers consent to the use of signal boosters. Some providers may not consent to the use of this device on their network. If you are unsure, contact your provider.

In Canada, **BEFORE USE** you must meet all requirements set out in ISED CPC-2-1-05.

You **MUST** operate this device with approved antennas and cables as specified by the manufacturer. Antennas **MUST** be installed at least 20 cm (8 inches) from (i.e., **MUST NOT** be installed within 20 cm of) any person.

You **MUST** cease operating this device immediately if requested by the FCC (or ISED in Canada) or licensed wireless service provider.

WARNING. E911 location information may not be provided or may be inaccurate for calls served by using this device.

This device may be operated **ONLY** in a fixed location (i.e., may operate in a fixed location only) for in-building use.

Safety Guidelines (cont.)

FOR MORE INFORMATION ON REQUIREMENTS SET OUT IN ISED CPC-2-1-05, SEE BELOW:

<http://www.ic.gc.ca/eic/site/smt-gst.nsf/eng/sf08942.html>

FOR MORE INFORMATION ON REGISTERING YOUR SIGNAL BOOSTER WITH YOUR WIRELESS PROVIDER, PLEASE SEE BELOW:

Sprint: <http://www.sprint.com/en/legal/signal-boosters.html?search=booster>

T-Mobile/MetroPCS: <https://support.t-mobile.com/docs/DOC-9827>

Verizon Wireless: <http://www.verizonwireless.com/wcms/consumer/register-signal-booster.html>

AT&T: <https://securec45.securewebsession.com/attsignalbooster.com/>

U.S. Cellular: <http://www.uscellular.com/uscellular/support/fcc-booster-registration.jsp>

Antenna Info

The following accessories are certified by the FCC to be used with the IoT 5-Band Direct-Connect Cell Signal Amplifier.

This radio transmitter 4726A-460019 has been approved by Innovation, Science and Economic Development Canada to operate with the antenna types listed below, with the maximum permissible gain indicated. Antenna types not included in this list that have a gain greater than the maximum gain indicated for any type listed are strictly prohibited for use with this device.

	BAND 12/17	BAND 13	BAND 5	BAND 4	BAND 25/2
Outside antenna maximum permissible antenna gain (dBi) 50Ω	4.5	4.2	4.46	3.71	4.74

OUTSIDE ANTENNA INFO				
#	Coax Type	Ln(ft)	Antenna Type	Ω
301126	LMR-100	10	Mini-Mag	50
304422	RG-58	30	Omni Plus	50

Specifications

IoT 5-Band Direct-Connect Cell Signal Amplifier					
Model	460019				
FCC	PWO460019				
IC	4726A-460019				
Connectors	SMA				
Antenna Impedance	50 Ohms				
Frequency	698-716 MHz, 746-787 MHz, 824-894 MHz, 1850-1995 MHz, 1710-1755/2110-2155 MHz				
Power output for single cell phone (Uplink) dBm	700 MHz B12/17 24.6	700 MHz B13 24.9	800 MHz B5 23.9	1700 MHz B4 23.9	1900 MHz B2 23.5
Power output for single cell phone (Downlink) dBm	-6.3	-6.1	-6.5	-6.8	-6.7
Noise Figure	4 dB (nominal)				
Isolation	> 40 dB				
Power Requirements	5V, 4A				

The term "IC" before the radio certification number only signifies that Industry Canada technical specifications were met. Each Signal Amplifier is individually tested and factory set to ensure FCC compliance. The Amplifier cannot be adjusted without factory reprogramming or disabling the hardware. The Signal Amplifier will amplify, but not alter incoming and outgoing signals in order to increase coverage of authorized frequency bands only. If the Signal Amplifier is not in use for five minutes, it will reduce gain until a signal is detected. If a detected signal is too high in a frequency band, or if the Signal Amplifier detects an oscillation, the Signal Amplifier will automatically turn the power off on that band. For a detected oscillation the Signal Amplifier will automatically resume normal operation after a minimum of 1 minute. After 5 (five) such automatic restarts, any problematic bands are permanently shut off until the Signal Amplifier has been manually restarted by momentarily removing power from the Signal Amplifier. Noise power, gain, and linearity are maintained by the Signal Amplifier's microprocessor. This device complies with Part 15 of FCC rules. Operation is subject to two conditions: (1) This device may not cause harmful interference, and (2) this device must accept any interference received, including interference that may cause undesired operation. Changes or modifications not expressly approved by Wilson Electronics LLC could void the authority to operate this equipment. This device contains licence-exempt transmitter(s)/receiver(s) that comply with Innovation, Science and Economic Development Canada's licence-exempt RSS(s). Operation is subject to the following two conditions: (1) This device may not cause interference, and (2) This device must accept any interference, including interference that may cause undesired operation of the device. Changes or modifications not expressly approved by Wilson Electronics LLC could void the authority to operate this equipment.

✔ 30 DAY MONEY-BACK GUARANTEE

All WilsonPro products are protected by WilsonPro 30-day money-back guarantee. If for any reason the performance of any product is not acceptable, simply return the product directly to the reseller with a dated proof of purchase.

✔ 3 YEAR WARRANTY

WilsonPro Amplifiers are warranted for three (3) years against defects in workmanship and/or materials. Warranty cases may be resolved by returning the product directly to the reseller with a dated proof of purchase.

Signal Amplifiers may also be returned directly to the manufacturer at the consumer's expense, with a dated proof of purchase and a Returned Material Authorization (RMA) number supplied by WilsonPro. WilsonPro shall, at its option, either repair or replace the product.

This warranty does not apply to any Signal Amplifiers determined by WilsonPro to have been subjected to misuse, abuse, neglect, or mishandling that alters or damages physical or electronic properties.

Replacement products may include refurbished WilsonPro products that have been recertified to conform with product specifications.

RMA numbers may be obtained by contacting Customer Support.

DISCLAIMER: The information provided by Wilson Electronics, LLC is believed to be complete and accurate. However, no responsibility is assumed by Wilson Electronics, LLC for any business or personal losses arising from its use, or for any infringements of patents or other rights of third parties that may result from its use.

MARKETING APPROVAL: Installer and end customer hereby grants to Wilson Electronics the express right to use installers or end customers company logo in marketing, sales, financial, and public relations materials and other communications solely to identify Customer as a Wilson Electronics customer.



3301 East Deseret Drive, St. George, UT

 866.294.1660  www.wilsonelectronics.com  support@wilsonelectronics.com

Copyright © 2019 Wilson Electronics. All rights reserved. Wilson Electronics products covered by U.S. patent(s) and pending application(s) For patents go to: weboost.com/us/patents

NOT AFFILIATED WITH WILSON ANTENNA

GDE000209_Rev03_12.11.19