

Product size:  
Dia110\*H75cm  
Dia140\*H75cm



The intended use of this product is for domestic use only.

Important, please retain for future reference.

Read carefully.



# Wentworth 110/140cm Round Table Assembly Instructions

## Before you start



### Warnings

#### IMPORTANT, RETAIN FOR FUTURE REFERENCE READ CAREFULLY

See enclosed instructions for assembly, safety and care information.

Failure to follow the warnings could result in serious injury.

Handle heavy parts with care.

Ensure that this product is fully assembled as illustrated before use.

This product should only be used on firm, level ground.

**Keep small parts out of reach of children.**

This product is intended for **domestic use** only.

Ensure the product is always placed on level ground.

Furniture can be dangerous if incorrectly used. No liability will be accepted for damage or injury caused by incorrect use of this product.

### ✓ Dos

When you are ready to start, make sure that you have the right tools, plenty of space and a clean, dry area for assembly.

Unwrap all packaging materials and place the components on a suitable surface to prevent scratching your product.

Check all contents are present prior to assembly as per the parts list provided. In the event of problems or missing parts, please contact the seller.

Check all screws and bolts are tightened and inspect regularly.

Cover furniture when not in use to add additional protection to your product.

During severe weather conditions, including high winds, rain, hail, thunderstorms, extreme heat and cold temperatures, the product should be stored inside in a cool, dry place.

To best preserve the synthetic rattan, please use a protective cover when your furniture is not in use. We would also recommend using a gazebo or parasol over your furniture during the summer period and prolonged sunny spells. This will help prevent harmful UV rays from damaging and discolouring the material.

Ensure that the product is clean and dry before storage.

Clean your product with a sponge and warm soapy water then wipe with a clean, dry cloth.

When cleaning glass panels use a damp cloth or leather with washing up liquid or soft soap if necessary

Where instructions as to the; storage, commissioning, installation, use and maintenance of the goods or (if there is none) good trade practice are not followed and a defect arises this will void the 12 month manufacturer's guarantee on the product.



### Don'ts

Do not use scourers, abrasives, washing powders, chemical cleaners or any other substances containing abrasives since these substances can damage the product, including the glass panel.

To preserve the table top design do not place greasy / oily items directly onto the surface. Use place-mats to prevent spillages of food or drink.

Do not place very hot or very cold items on the glass surface unless adequately thick table-mats are used to prevent such items from coming into contact with the glass.

Do not use the table as a chopping surface.

Do not strike the table with hard or pointed items.

Do not sit or lean on the table.

Do not use power tools to construct this product.

Do not use this product if parts are missing, damaged or worn.

Do not stand or climb onto the product and do not use it as a ladder, as this could lead to it unbalancing and overturning.

Never drag furniture when moving it, always lift it.

### Number of people required for assembly

Two people.

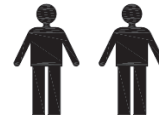

### Time to assemble



30 Minutes

### Tools required



### Tips:







**It is best not to fully tighten the nuts and bolts until they are all correctly located. Only carefully tighten them when you are satisfied with the alignment of all components.**

**Be careful not to overtighten.**

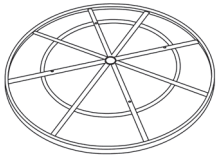
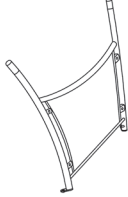
[www.a-mir.co.uk](http://www.a-mir.co.uk)

# Wentworth 110/140cm Round Table Assembly Instructions

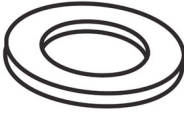
Components, fixtures & fittings (not actual size)

Parts List					
Part No.	Diagram	Qty	Part No.	Diagram	Qty
A	 Table Top Frame	1 PC	B	 Leg	2 PCS
C	 Connecting Panel	2 PCS	D	 Glass Top	1 PC
E	 Bolt Head Cap	12 PCS	F	 M6 Bolt	12 PCS
G	 Washer	12 PCS	H	 Spacer	8 PCS
I	 Spanner	1 PC			

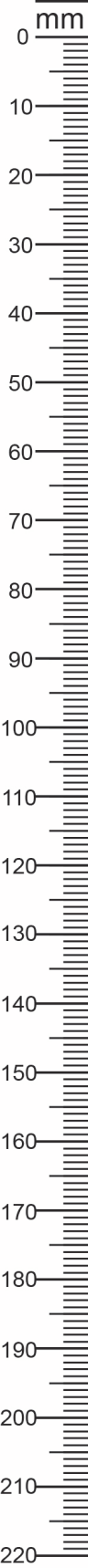

# Wentworth 110/140cm Round Table Assembly Instructions

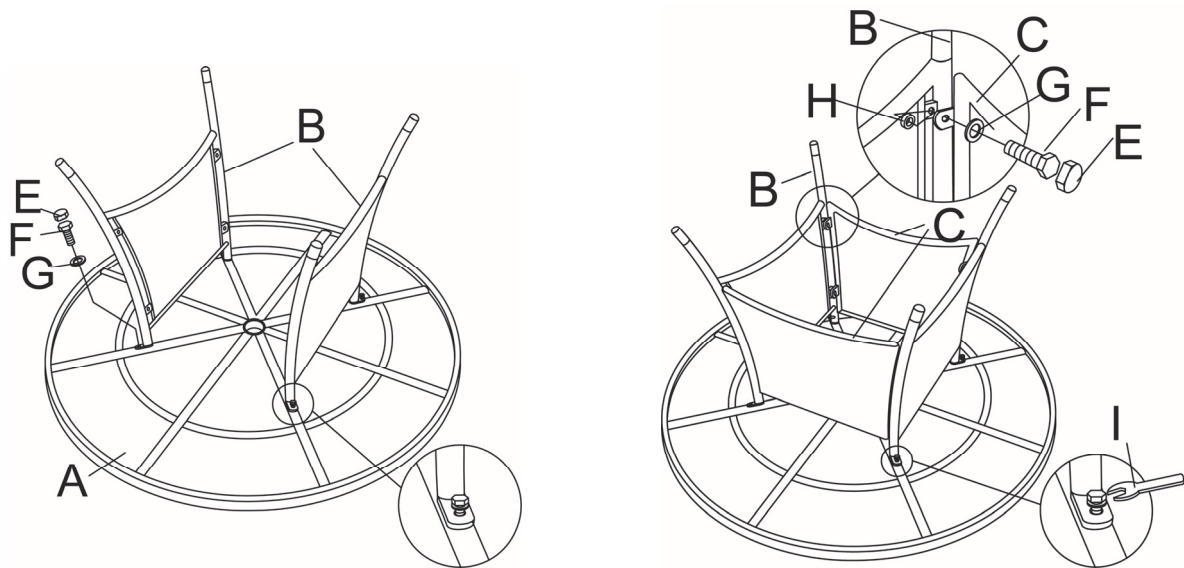

## Step by step assembly instructions

### Step One

Open the packaging with the glass face down on a flat surface. Leave the glass on the carton until the rest of the table is fully assembled.

With the help of another person, place Table Top Frame (A) upside down on a flat, non-abrasive surface to avoid scratching the table surface or rim.

### Step Two

Do NOT assemble the Legs (B) to the Table Top Frame (A) while it is still resting on the Glass Top (D).

Loosely attach the Table Legs (B) to the Table Top Frame (A) using Washers (G) and Bolts (F).

# Wentworth 110/140cm Round Table Assembly Instructions

## Step Three

Loosely attach the Connecting Panels (C) onto the Table Top Frame (A) and Table Legs (B), aligning all holes in each part, using Spacers (H), Washers (G) and Bolts (F). Only tighten the bolts when all bolts and washers are in place. Once you are satisfied with the alignment of the components carefully tighten all bolts using Spanner (I).

Do not over-tighten.  
Cover each bolt with Bolt Head Cap (E).

## Step Four

With the help of another person, carefully turn the table in the upright position. Level the table by adjustable feet screw.

Carefully place the Glass Top (D) on the Table Top Frame (A) and make sure they are aligned. There are plastic suction caps pre-fitted onto the table top, make sure the glass top is in full contact with the plastic suction caps.

Your table is now ready for use.

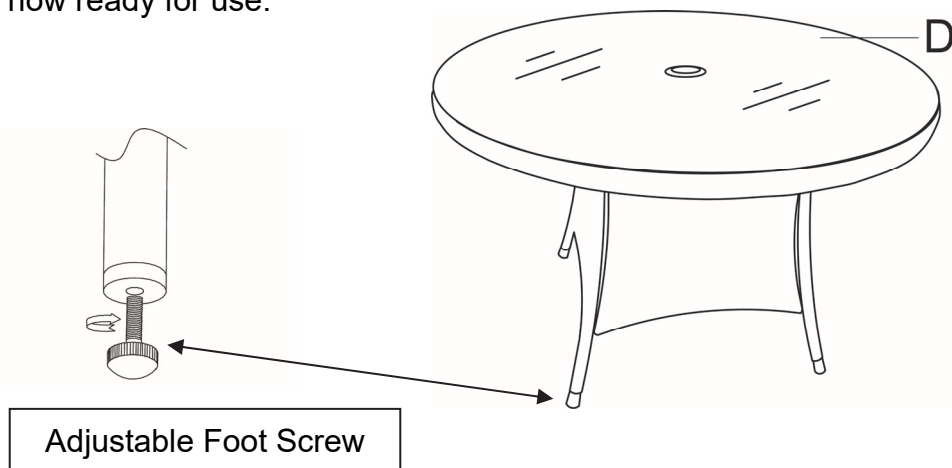

**Note: This table is not designed to hold the parasol separately.**

**Parasol base with suitable weight should always be used.**

**PLEASE KEEP THESE INSTRUCTIONS FOR FUTURE REFERENCE**