

Product size:
L90*W90*H74 cm

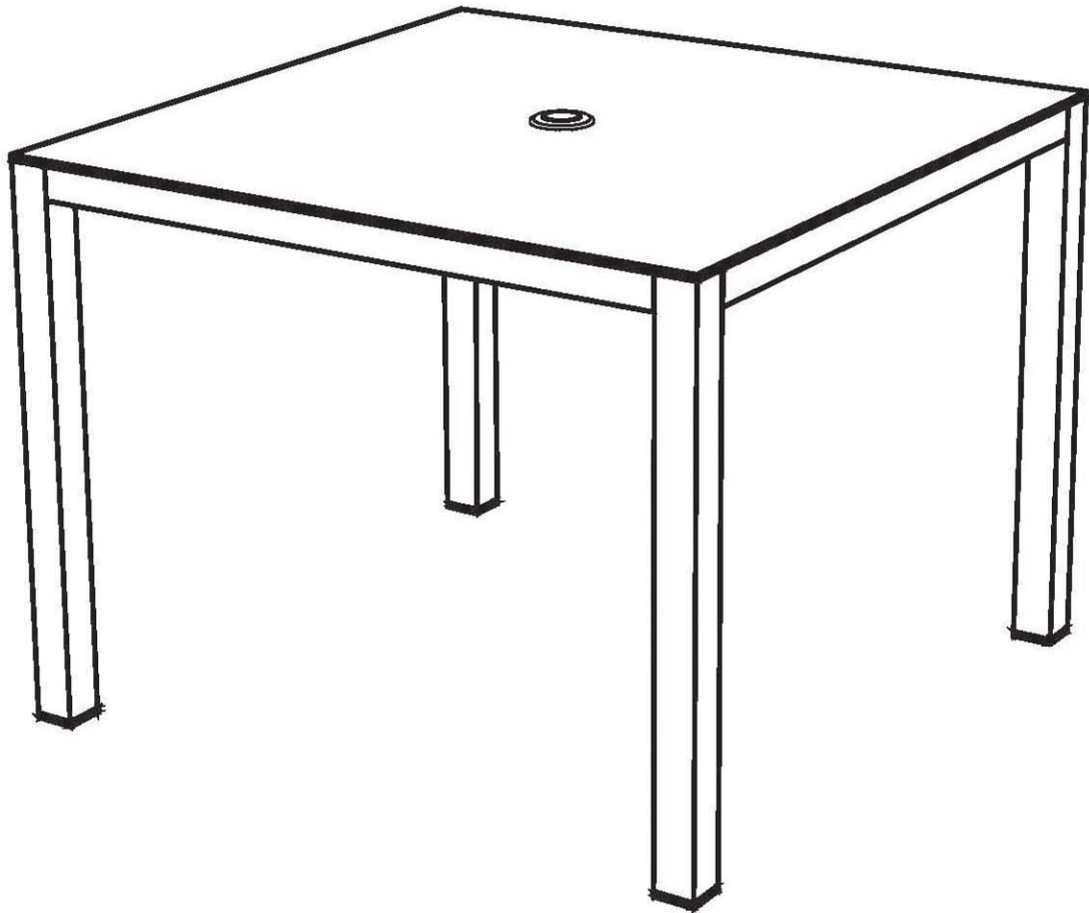

The intended use of this product is for domestic use only.

Important, please retain for future reference.

Read carefully.

www.royalcraft.co.uk

Before you start

Warnings

IMPORTANT, RETAIN FOR FUTURE REFERENCE READ CAREFULLY

See enclosed instructions for assembly, safety and care information.

Failure to follow the warnings could result in serious injury.

Handle heavy parts with care.

Ensure that this product is fully assembled as illustrated before use.

This product should only be used on firm, level ground.

Keep small parts out of reach of children.

This product is intended for **domestic use** only.

Ensure the product is always placed on level ground.

Furniture can be dangerous if incorrectly used. No liability will be accepted for damage or injury caused by incorrect use of this product.

Dos

Unwrap all packaging materials and place the components on a suitable surface to prevent scratching your product.

Check all contents are present prior to assembly as per the parts list provided. In the event of problems or missing parts, please contact the seller.

Check all screws and bolts are tightened and inspect regularly.

Make sure the legs remain in contact with the ground.

During severe weather conditions, including high winds, rain, hail, thunderstorms, extreme heat and cold temperatures, the product should be stored inside in a cool, dry place.

To best preserve this product, please use a protective cover when your furniture is not in use. We would also recommend using a gazebo or parasol over your furniture during the summer period and prolonged sunny spells. This will help prevent harmful UV rays from damaging and discolouring the material.

Frames are manufactured using powder coated aluminum tubing. Any scratches on the paintwork should be touched up immediately with metal paint to prevent corrosion.

Ensure that the product is clean and dry before storage.

Clean your product with a sponge and warm soapy water then wipe with a clean, dry cloth.

Where instructions as to the; storage, commissioning, installation, use and maintenance of the goods or (if there is none) good trade practice are not followed and a defect arises this will void the 12 month manufacturer's guarantee on the product.

Don'ts

Do not use scourers, abrasives, washing powders, chemical cleaners or any other substances containing abrasives since these substances can damage the product, including the glass panel.

To preserve the table top design do not place greasy / oily items directly onto the surface. Use place-mats to prevent spillages of food or drink.

Do not place very hot or very cold items on the glass surface unless adequately thick table-mats are used to prevent such items from coming into contact with the glass.

Do not use the table as a chopping surface.

Do not strike the table with hard or pointed items.

Do not sit or lean on the table.

Do not use power tools to construct this product.

Do not use this product if parts are missing, damaged or worn.

Do not stand or climb onto the product and do not use it as a ladder, as this could lead to it unbalancing and overturning.

Never drag furniture when moving it, always lift it.

Number of people required for assembly

Two people



Time to assemble



30 minutes

Tools required







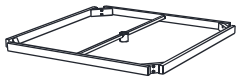

Tips:

It is best not to fully tighten the nuts and bolts until they are all correctly located. Only carefully tighten them when you are satisfied with the alignment of all components.

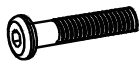
Be careful not to overtighten.

Components, fixtures & fittings (not actual size)

Parts List					
Part No.	Diagram	Qty.	Part No.	Diagram	Qty.
A	 Table Top Frame	1 PC	B	 Table Leg	4 PCS
C	 Glass Top	1 PC	D	 Bolt	8 PCS
E	 Spring Washer	8 PCS	F	 Washer	8 PCS
G	 Bolt Head Cap	8 PCS	H	 Allen Key	1 PC

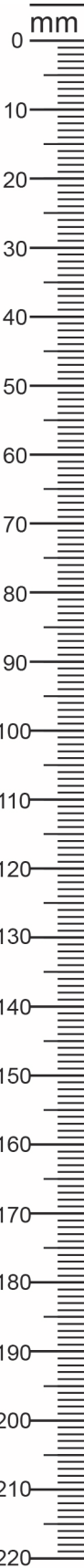

Step by step assembly instructions

Step One

Place the Glass Top (C) at a safe, flat surface, don't let it hinder the assembly of other components.

With the help of another person, place Table Top Frame (A) upside down on a flat, non-abrasive surface to avoid scratching the table surface or rim.

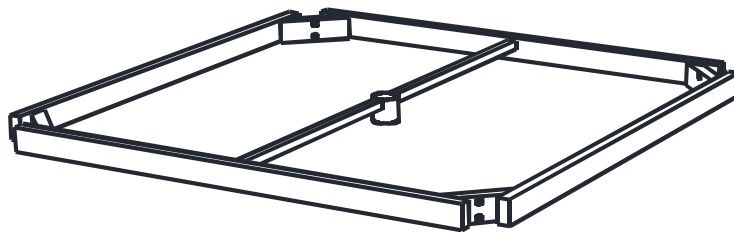

Step Two

Attach the Table Legs (B) onto the Table Top Frame (A) using Washers (F), Spring Washers (E) and Bolts (D).

Only tighten the bolts when all bolts and washers are in place and turn freely. Once you are satisfied with the alignment of the components, carefully tighten all bolts using Allen Key (H). Do not over-tighten.

Cover each bolt with Bolt Head Caps (G).

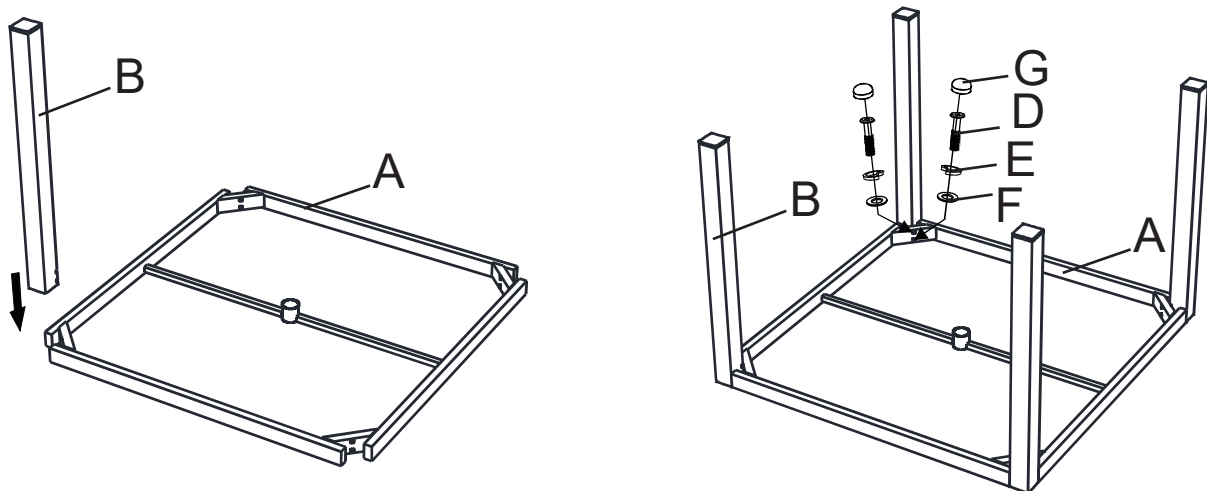

Step Three

With the help of another person, carefully turn over the table frame and place it in the upright position.

Carefully place the Glass Top (C) onto the Table Top Frame (A), make sure they match each other.

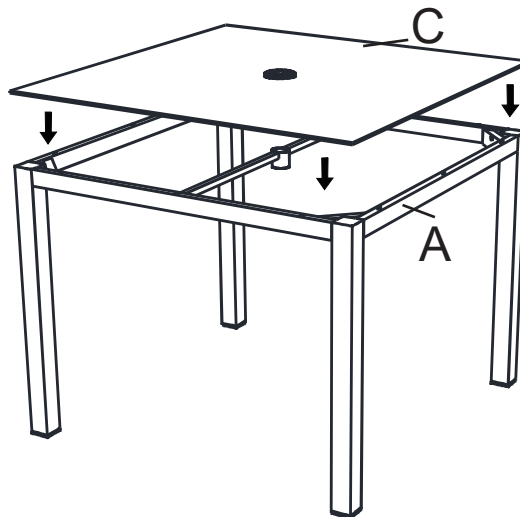

Step Four

There are adjustable feet screws at the bottom of the legs.

Make sure there is no wobbling by adjusting the feet screws when the table is placed on the flat ground.

Your table is now ready for use.

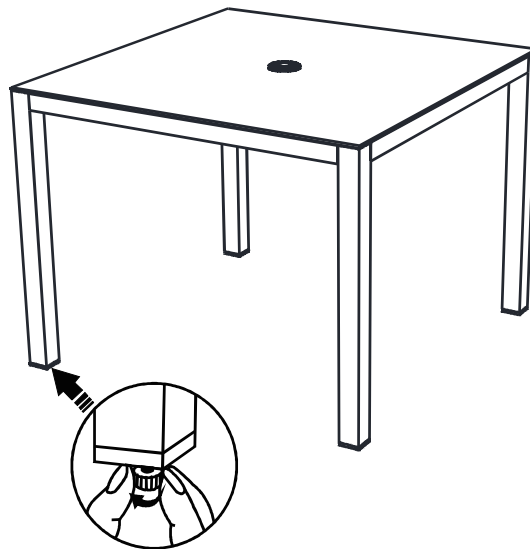

Note: This table is not designed to hold the parasol separately.

Parasol base with suitable weight should always be used.

PLEASE KEEP THESE INSTRUCTIONS FOR FUTURE REFERENCE

www.royalcraft.co.uk