

Product size: L140*W80*H70 cm



The frame of this product is manufactured from mild steel coated with a weather resistant paint. Steel has a natural tendency to rust over time and, whilst we expect you to be able to enjoy your furniture for many years to come, we recommend that you check the product from time to time for signs of paint damage and/ or rust. If the paint should become damaged, or if rust begins to form, you should clean the affected area and apply a suitable "thinners based" touch-up paint. Such paints are readily available from all good hardware and DIY stores.

The intended use of this product is for domestic use only.

Important, please retain for future reference.

Read carefully.

Rio 6 Seater Black Glass Table

Assembly Instructions

Before you start



Warnings

IMPORTANT, RETAIN FOR FUTURE REFERENCE READ CAREFULLY

See enclosed instructions for assembly, safety and care information.

Failure to follow the warnings could result in serious injury.

Handle heavy parts with care.

Ensure that this product is fully assembled as illustrated before use.

This product should only be used on firm, level ground.

Keep small parts out of reach of children.

This product is intended for **domestic use** only.

Ensure the product is always placed on level ground.

Furniture can be dangerous if incorrectly used. No liability will be accepted for damage or injury caused by incorrect use of this product.

✓ Dos

When you are ready to start, make sure that you have the right tools, plenty of space and a clean, dry area for assembly.

Unwrap all packaging materials and place the components on a suitable surface to prevent scratching your product.

Check all contents are present prior to assembly as per the parts list provided. In the event of problems or missing parts, please contact the seller.

Check all screws and bolts are tightened and inspect regularly.

Cover furniture when not in use to add additional protection to your product.

During severe weather conditions, including high winds, rain, hail, thunderstorms, extreme heat and cold temperatures, the product should be stored inside in a cool, dry place.

To best preserve this product, please use a protective cover when your furniture is not in use. We would also recommend using a gazebo or parasol over your furniture during the summer period and prolonged sunny spells. This will help prevent harmful UV rays from damaging and discolouring the material.

Ensure that the product is clean and dry before storage.

Clean your product with a sponge and warm soapy water then wipe with a clean, dry cloth.

When cleaning glass panels use a damp cloth or leather with washing up liquid or soft soap if necessary

Where instructions as to the; storage, commissioning, installation, use and maintenance of the goods or (if there is none) good trade practice are not followed and a defect arises this will void the 12 month manufacturer's guarantee on the product.

✗ Don'ts

Do not use scourers, abrasives, washing powders, chemical cleaners or any other substances containing abrasives since these substances can damage the product, including the glass panel.

To preserve the table top design do not place greasy / oily items directly onto the surface. Use place-mats to prevent spillages of food or drink.

Do not place very hot or very cold items on the glass surface unless adequately thick table-mats are used to prevent such items from coming into contact with the glass.

Do not use the table as a chopping surface.

Do not strike the table with hard or pointed items.

Do not sit or lean on the table.

Do not use power tools to construct this product.

Do not use this product if parts are missing, damaged or worn.

Do not stand or climb onto the product and do not use it as a ladder, as this could lead to it unbalancing and overturning.

Never drag furniture when moving it, always lift it.

Number of people required for assembly

Two people



Time to assemble



30 Minutes

Tools required

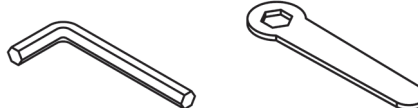

Tips:

Do NOT fully tighten bolts before all components are connected. Only fully tighten once you are satisfied with the alignment of all components.









Do not over-tighten the bolts.

www.royalcraft.co.uk

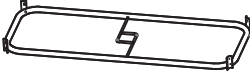
Rio 6 Seater Black Glass Table

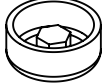
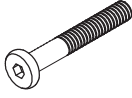
Assembly Instructions

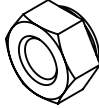
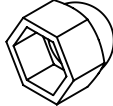
Components, fixtures & fittings (not actual size)

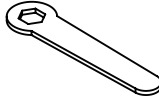
Parts List					
Part No.	Diagram	Qty.	Part No.	Diagram	Qty.
A	 Table Top	1 PC	B	 Table Leg	4 PCS
C	 Connecting Ring	1 PC	D	 M6*32mm Bolt	4 PCS
E	 Bolt Head Cap	8 PCS	F	 M6*55mm Bolt	4 PCS
G	 Washer	8 PCS	H	 Nut	8 PCS
I	 Nut Cap	8 PCS	J	 Parasol Hole Cap (Pre-Assembled)	1 PC
K	 Allen Key	1 PC	L	 Spanner	1 PC

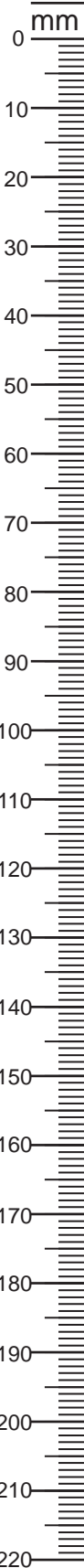

Rio 6 Seater Black Glass Table

Assembly Instructions

Step by step assembly instructions

Note: Tighten only enough to hold parts in place. Do not tighten completely during assembly. Some adjustments may be necessary to ensure all parts are aligned properly. Only tighten the bolts when all bolts and washers are in place.

Step One

With the help of another person, place Table Top (A) upside down on a flat, non-abrasive surface to avoid scratching the table surface or rim. Locate the assembly position on the bottom side of the Table Top (A). It is a plastic socket. Attach the Table Legs (B) onto the assembly position.

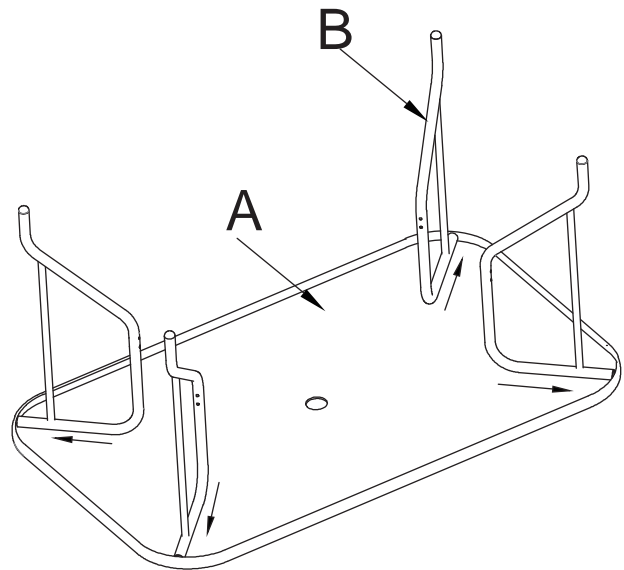

Step Two

Place the Connecting Ring (C) onto the Table Legs (B), using Bolt Head Caps (E), Bolts (D&F), Flat Washers (G), Nuts (H) and Nut Caps (I).

Once you are satisfied with the alignment of the components, carefully tighten all bolts using Allen Key (K) and Spanner (L). Do not over-tighten. Cover each bolt with Bolt Head Cap (E).

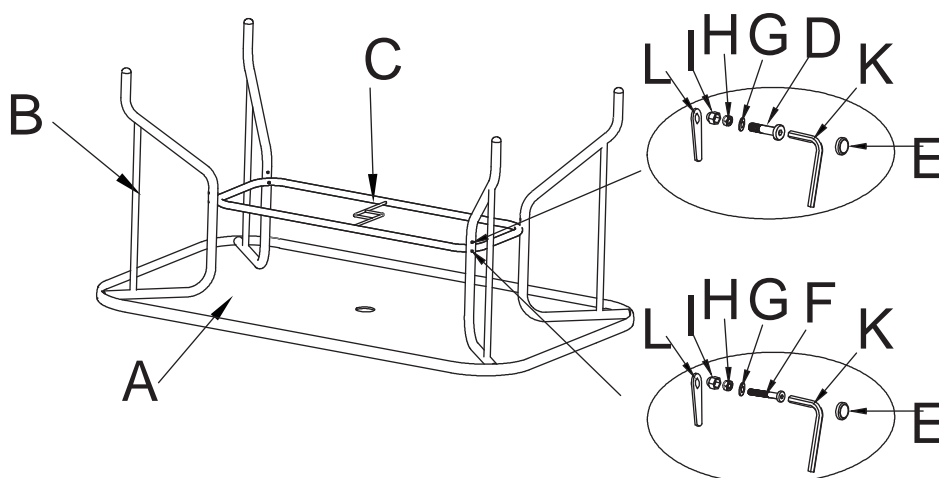

Rio 6 Seater Black Glass Table

Assembly Instructions

Step Three

With the help of another person, carefully turn over the table and place it in the upright position. Make sure there is no wobbling when the table is placed on the flat ground.

Your table is now ready for use.

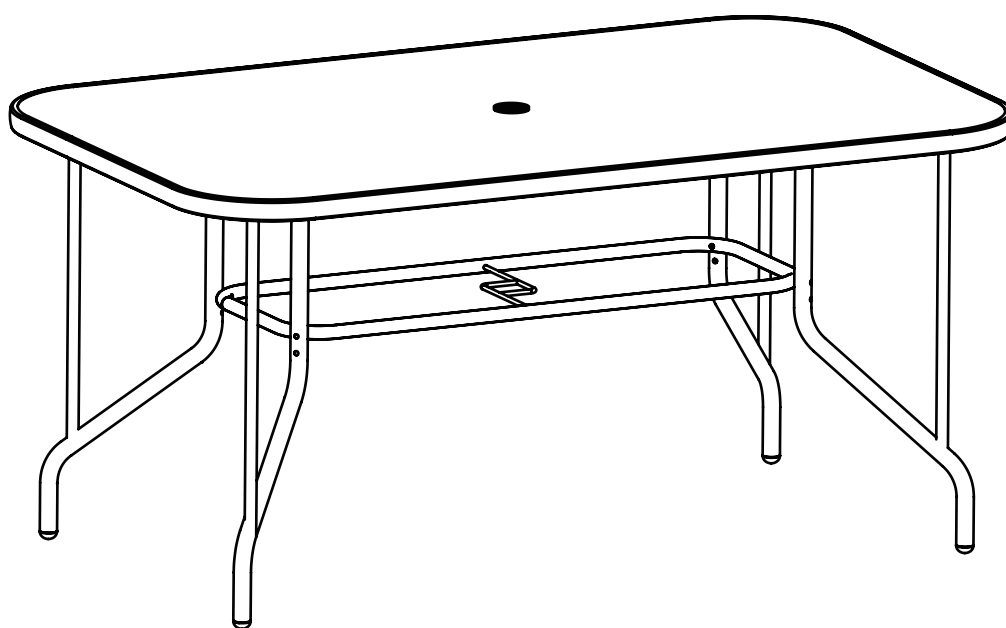

Note: When using a parasol with this table always use a suitable base weight.
PLEASE KEEP THESE INSTRUCTIONS FOR FUTURE REFERENCE