

Product size:
Dia70*H73.5 cm

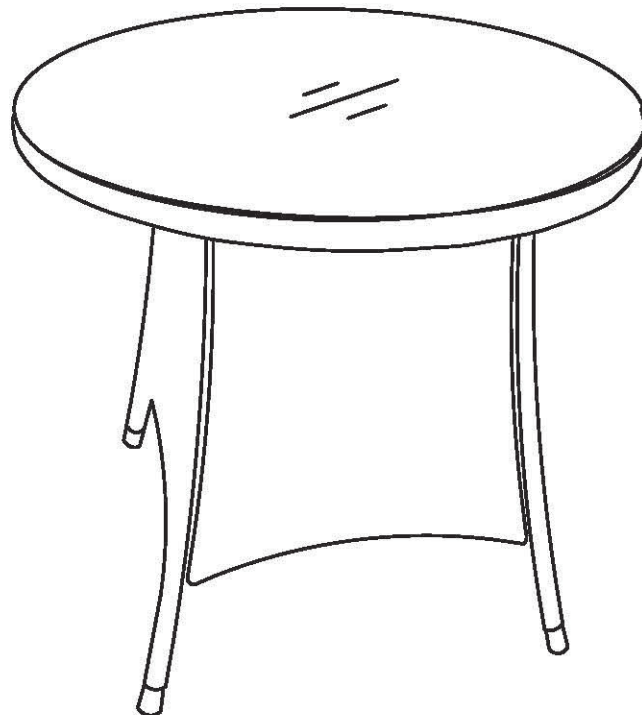

**Furniture should be covered/stored whilst not in use to prolong its longevity.
(It should also be covered in adverse weather.)**

The intended use of this product is for Domestic use only.

Important, please retain for future reference.

Read carefully.

NEVADA 70CM ROUND TABLE

Assembly instructions

Before you start



Warnings

IMPORTANT, RETAIN FOR FUTURE REFERENCE READ CAREFULLY

See enclosed instructions for assembly, safety and care information.

Failure to follow the warnings could result in serious injury.

Handle heavy parts with care.

Ensure that this product is fully assembled as illustrated before use.

This product should only be used on firm, level ground.

Keep small parts out of reach of children.

Do not stand or climb onto this product.

This product is intended for **domestic use** only.

Furniture can be dangerous if incorrectly used. No liability will be accepted for damage or injury caused by incorrect use of this product.



Dos

When you are ready to start, make sure that you have the right tools, plenty of space and a clean, dry area for assembly.

Unwrap all packaging materials and place the components on a suitable surface to prevent scratching your product.

Check the pack and make sure you have all parts listed. In the event of problems or missing parts, please contact the seller.

Check all screws and bolts are tightened and inspect regularly.

This product is suitable for all year outdoor use. However, to prolong its life we recommend that during severe weather conditions, including high winds, rain, hail, thunderstorms, extreme heat and cold temperatures, the product should be stored inside in a cool, dry place.

To best preserve the synthetic rattan, please use a protective cover when your furniture is not in use. We would also recommend using a gazebo or parasol over your furniture during the summer period and prolonged sunny spells. This will help prevent harmful UV rays from damaging and discolouring the material.

Ensure that the product is clean and dry before storage.

Clean your product with a sponge and warm soapy water then wipe with a clean, dry cloth.

When cleaning glass panels use a damp cloth or leather with washing up liquid or soft soap if necessary.

Where instructions as to the; storage, commissioning, installation, use and maintenance of the goods or (if there is none) good trade practice are not followed and a defect arises this will void the 12 month manufacturer's guarantee on the product.

Don'ts

Do not use scourers, abrasives, washing powders, chemical cleaners or any other substances containing abrasives since these substances can damage the product, including the glass panel.

To preserve the table top design do not place greasy / oily items directly onto the surface. Use place-mats to prevent spillages of food or drink.

Do not place very hot or very cold items on the glass surface unless adequately thick table-mats are used to prevent such items from coming into contact with the glass.

Do not use the table as a chopping surface.

Do not strike the table with hard or pointed items.

Do not sit or lean on the table.

Do not use power tools to construct this product.

Do not use this product if parts are missing, damaged or worn.

Do not stand or climb onto the product and do not use it as a ladder, as this could lead to it unbalancing and overturning.

Never drag furniture when moving it, always lift it.

Number of people required for assembly

Two people.



Time to assemble



30 Minutes

Tools required



Tips:





It is best not to fully tighten the nuts and bolts until they are all correctly located. Only carefully tighten them when you are satisfied with the alignment of all components.

Be careful not to overtighten.

NEVADA 70CM ROUND TABLE

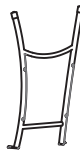
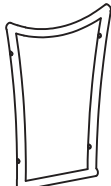
Assembly instructions

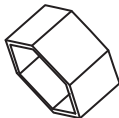
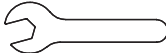
Components, fixtures & fittings (not actual size)

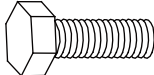
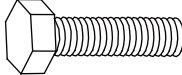
Parts List					
Part No.	Diagram	Qty.	Part No.	Diagram	Qty.
A	 Table Top Frame	1 PC	B	 Table Leg	2 PCS
C	 Connecting Panel	2 PCS	D	 Glass Top	1 PC
F2	 Bolt Head Cap	12 PCS	S1	 Spanner	1 PC
F3	 Flat Washer	12 PCS	F4	 Spring Washer	12 PCS
W20	 M6*20mm Bolt	4 PCS	W35	 M6*35mm Bolt	8 PCS

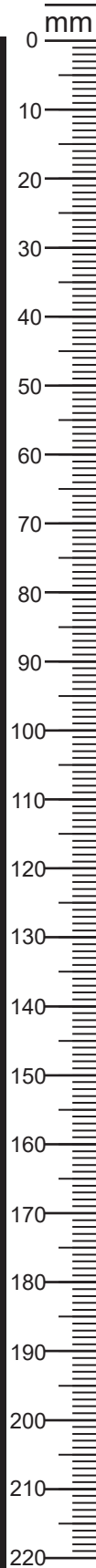

NEVADA 70CM ROUND TABLE

Assembly instructions

Step by step assembly instructions

All Bolt Head Caps should not be attached before finally tightening all Bolts with Spanner.

Step One

Open the packaging with the glass face down on a flat surface. Leave the glass on the carton until the rest of the table is fully assembled.

With the help of another person, place Table Top Frame (A) upside down on a flat, non-abrasive surface to avoid scratching the table surface or rim.

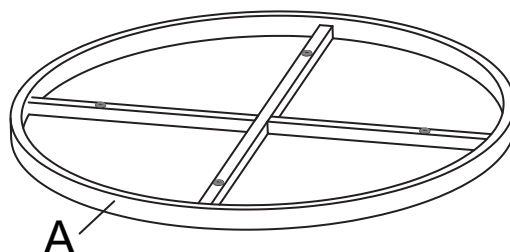

Step Two

Do NOT assemble the Table Legs (B) to the Table Top Frame (A) while it is still resting on the Glass Top (D). Loosely attach the Table Legs (B) to the Table Top Frame (A) using Bolt Head Caps (F2), Bolts (W20), Spring Washers (F4) and Flat Washers (F3).

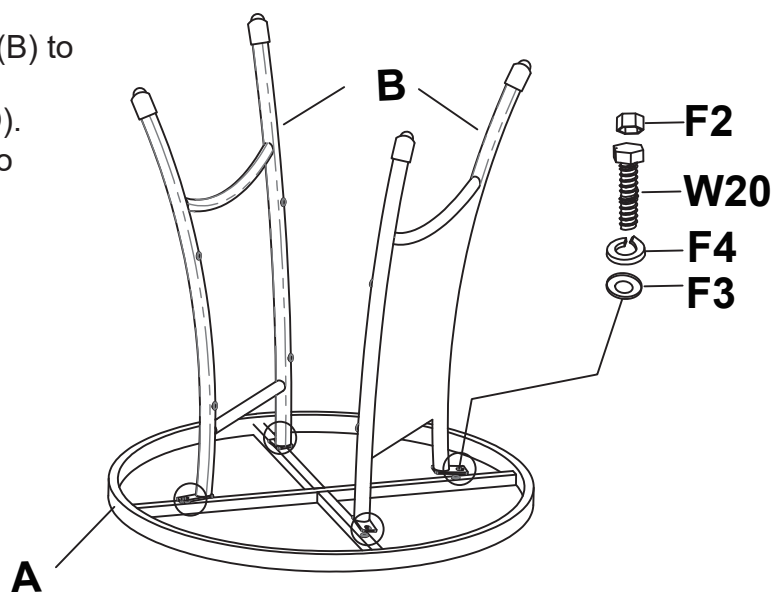

NEVADA 70CM ROUND TABLE

Assembly instructions

Step Three

Loosely attach the Connecting Panels (C) between the Table Legs (B) using Bolt Head Caps (F2), Bolts (W35), Spring Washers (F4) and Flat Washers (F3).

Only tighten the bolts when all bolts and washers are in place.

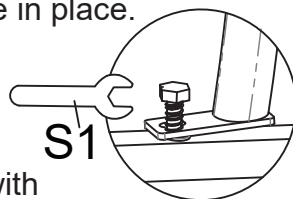

Once you are satisfied with the alignment of the components carefully tighten all bolts using Spanner (S1). Do not over-tighten. Cover each bolt with Bolt Head Cap (F2).

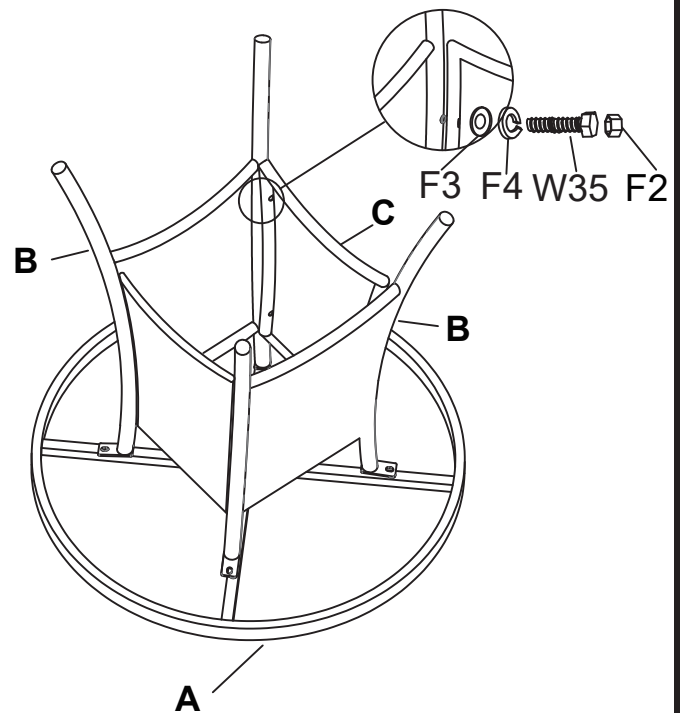

Step Four

With the help of another person, carefully turn the table in the upright position.

Level the table by adjustable feet screw.

Carefully place the Glass Top (D) on the Table Top Frame (A) and make sure they are aligned.

Your table is now ready for use.

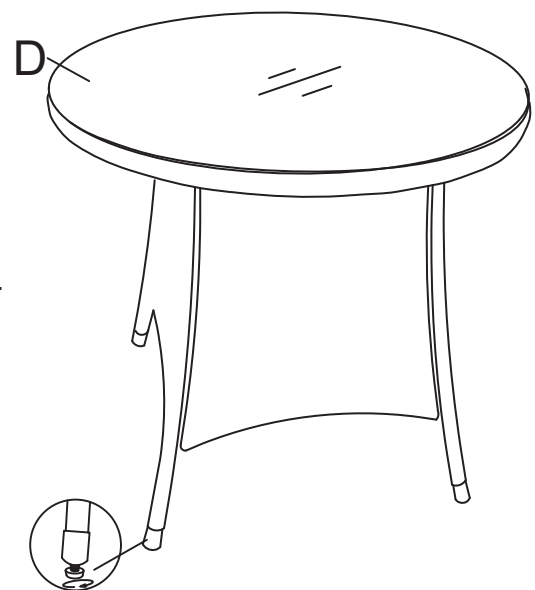

Adjustable Foot Screw

PLEASE KEEP THESE INSTRUCTIONS FOR FUTURE REFERENCE