

Product size:  
Coffee Table: Dia50\*H52cm  
Egg Chair: W73\*D80\*H90cm



The intended use of this product is for domestic use only.

Important, please retain for future reference.

Read carefully.



# Monaco 3pc Egg Chair Bistro Set

## Assembly instructions

### Before you start



#### Warnings

##### **IMPORTANT, RETAIN FOR FUTURE REFERENCE READ CAREFULLY**

See enclosed instructions for assembly, safety and care information.

Failure to follow the warnings could result in serious injury.

Handle heavy parts with care.

Ensure that this product is fully assembled as illustrated before use.

This product should only be used on firm, level ground.

##### **Keep small parts out of reach of children.**

Do not stand or climb onto this product.

This product is intended for **domestic use** only.

Ensure the product is always placed on level ground.

Furniture can be dangerous if incorrectly used. No liability will be accepted for damage or injury caused by incorrect use of this product.



#### Dos

When you are ready to start, make sure that you have the right tools, plenty of space and a clean, dry area for assembly.

Unwrap all packaging materials and place the components on a suitable surface to prevent scratching your product.

Check all contents are present prior to assembly as per the parts list provided. In the event of problems or missing parts, please contact the seller.

Check all screws and bolts are tightened and inspect regularly.

Cover furniture when not in use to add additional protection to your product.

During severe weather conditions, including high winds, rain, hail, thunderstorms, extreme heat and cold temperatures, the product should be stored inside in a cool, dry place.

To best preserve the synthetic rattan, please use a protective cover when your furniture is not in use. We would also recommend using a gazebo or parasol over your furniture during the summer period and prolonged sunny spells. This will help prevent harmful UV rays from damaging and discolouring the material.

Ensure that the product is clean and dry before storage.

Clean your product with a sponge and warm soapy water then wipe with a clean, dry cloth.

Where instructions as to the; storage, commissioning, installation, use and maintenance of the goods or (if there is none) good trade practice are not followed and a defect arises this will void the 12 month manufacturer's guarantee on the product.



#### Don'ts

Do not use scourers, abrasives, washing powders, chemical cleaners or any other substances containing abrasives since these substances can damage the product, including the glass panel.

To preserve the table top design do not place greasy / oily items directly onto the surface. Use place-mats to prevent spillages of food or drink.

Do not place very hot or very cold items on the glass surface unless adequately thick table-mats are used to prevent such items from coming into contact with the glass.

Do not use the table as a chopping surface.

Do not strike the table with hard or pointed items.

Do not sit or lean on the table.

Do not use power tools to construct this product.

Do not use this product if parts are missing, damaged or worn.

Do not stand or climb onto the product and do not use it as a ladder, as this could lead to it unbalancing and overturning.

Never tilt the chairs during use.

Never drag furniture when moving it, always lift it.

#### Number of people required for assembly

One person



#### Time to assemble



30 minutes

#### Tools required



#### Tips: .

**It is best not to fully tighten the nuts and bolts until they are all correctly located. Only carefully tighten them when you are satisfied with the alignment of all components.**



**Be careful not to overtighten.**

[www.royalcraft.co.uk](http://www.royalcraft.co.uk)



# Monaco 3pc Egg Chair Bistro Set











## Assembly instructions

Member Part					
Part No.	Diagram	Qty.	Part No.	Diagram	Qty.
MP1	 Coffee Table	1 PC	MP2	 Chair	2 PCS

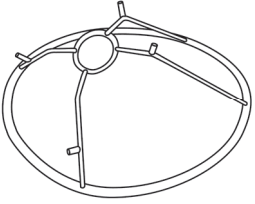
# Monaco 3pc Egg Chair Bistro Set

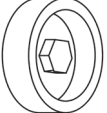
## Assembly instructions

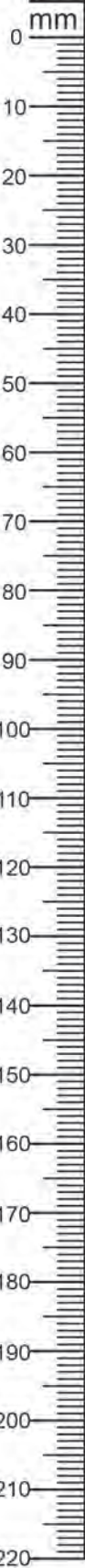

Components, fixtures & fittings (not actual size)

Parts List					
Part No.	Diagram	Qty.	Part No.	Diagram	Qty.
A	 Table Top Frame	1 PC	B	 Coffee Table Upper Leg	1 PC
C	 Coffee Table Bottom Leg	1 PC	D	 Coffee Table Glass Top	1 PC
E	 Chair Seat	2 PCS	F	 Chair Leg	8 PCS
G	 Bolt Head Cap	5 PCS	H	 M6*15mm Bolt	5 PCS
I	 Washer	6 PCS	J	 Nut	1 PC

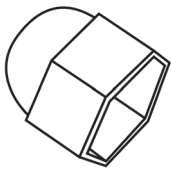

# Monaco 3pc Egg Chair Bistro Set

## Assembly instructions

K	 Nut Cap	1 PC	L	 Spanner	1 PC
M	 Allen Key	1 PC			

### Step by step assembly instructions

**Note:** Tighten only enough to hold parts in place. Do not tighten completely during assembly. Some adjustments may be necessary to ensure all parts are aligned properly. Only tighten the bolts when all bolts and washers are in place.

### MP1 – Coffee Table

#### Step One

Take out the components, identify the Table Top Frame (A) and Glass Top (D). Place the Glass Top (D) onto a safe, even and soft place without scratching the glass.

#### Step Two

Cross and combine the Coffee Table Upper Leg (B) and Coffee Table Bottom Leg (C), using Bolt Head Cap (G), Bolt (H), Washer (I), Nut (J), Spanner (L), Allen Key (M) and Nut Cap (K).

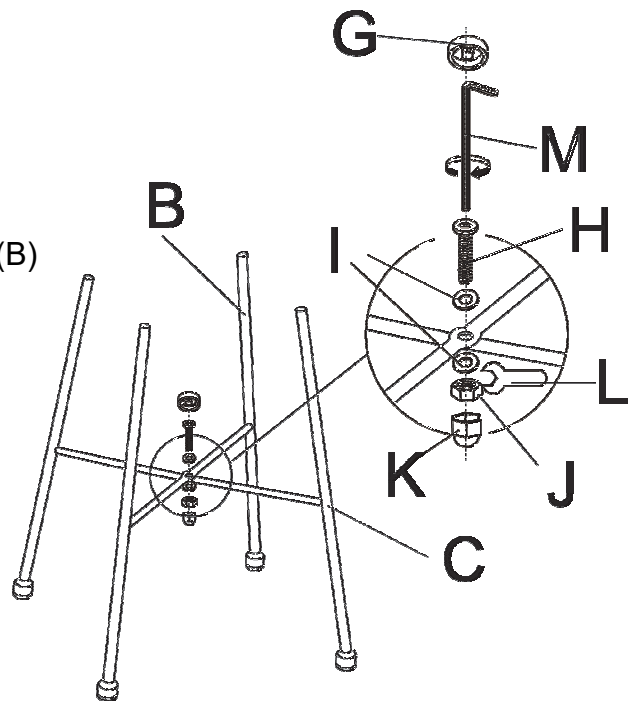

# Monaco 3pc Egg Chair Bistro Set

## Assembly instructions

### Step Three

Assemble the Coffee Table Top (A) to the Coffee Table Legs (B & C), using Bolt Head Cap (G), Bolt (H), and Washer (I).

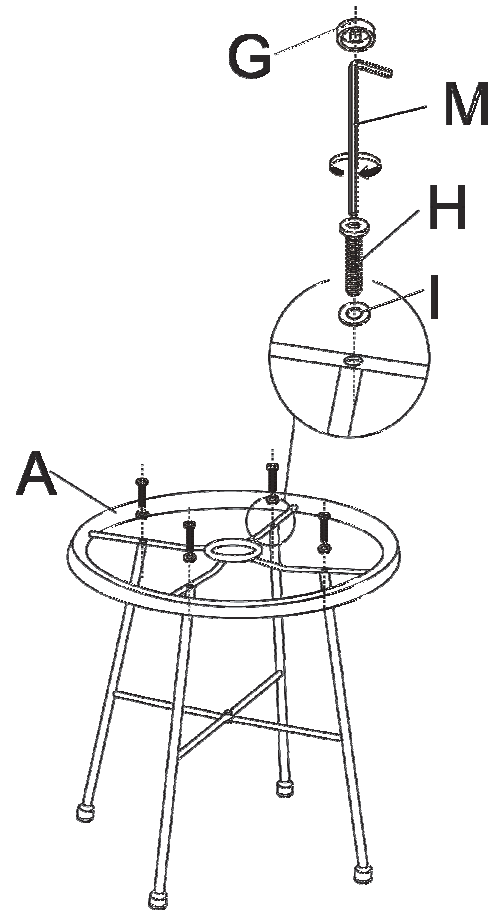

### Step Four

Level the table with adjustable feet screws under the legs, carefully place the Glass Top (D) onto the Table Top Frame (A), make sure it is fully rested on the suction caps which are pre-fitted on the table top frame.

Your table is now ready for use.



Adjustable foot screw.

# Monaco 3pc Egg Chair Bistro Set

## Assembly instructions

### MP2 - Chair

#### Step One

Place the Chair Seat (E) onto a safe, even and soft place without scratching the surface.

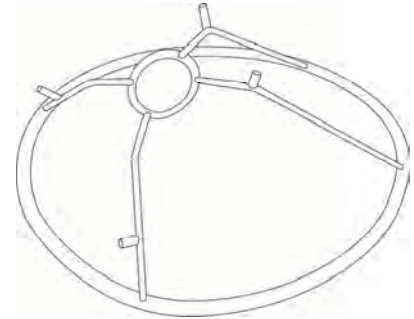

#### Step Two

Screw the Chair Legs (F) into the Chair Seat (E) until the Legs are fully screwed into the Chair Seat assembly. Lift the Chair in the upright position, level the chair with adjustable feet screws under the legs, your Chair is now ready for use.

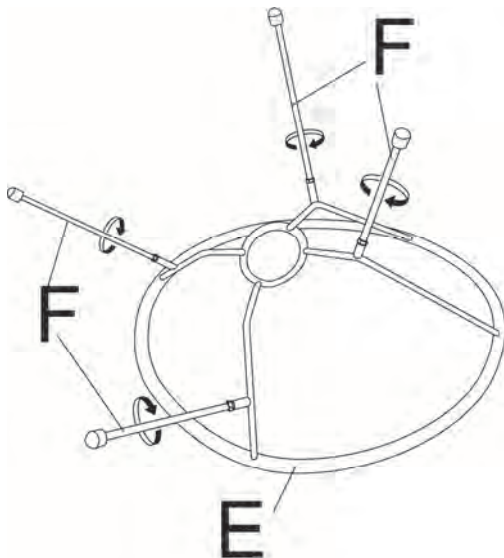

Adjustable foot screw.

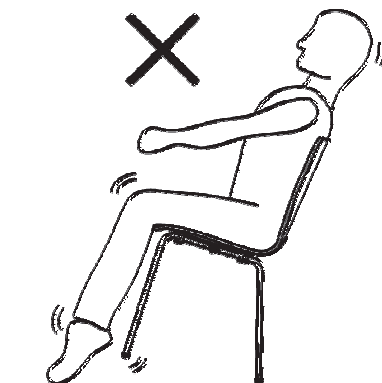

#### Warning

Never tilt the Chair during use. Ensure the product is always placed firmly on the ground.

**PLEASE KEEP THESE INSTRUCTIONS FOR FUTURE REFERENCE**

[www.royalcraft.co.uk](http://www.royalcraft.co.uk)