

Product size:

MIDDLE CHAIR: W72.5*D80*H76.5 CM X 1

CORNER CHAIR: W80*D80*H76.5 CM X 1

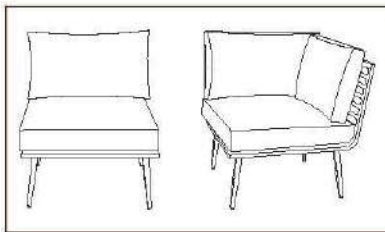

Furniture should be covered/stored whilst not in use to prolong its longevity.
(It should also be covered in adverse weather.)

The intended use of this product is for domestic use only.
Important, please retain for future reference.

Read carefully.

Before you start

Warnings

IMPORTANT, RETAIN FOR FUTURE REFERENCE READ CAREFULLY

See enclosed instructions for assembly, safety and care information.

Failure to follow the warnings could result in serious injury.

Handle heavy parts with care.

Ensure that this product is fully assembled as illustrated before use.

This product should only be used on firm, level ground.

The product contains small parts which could pose a risk to young children. Keep small parts out of reach of children.

This product is intended for **domestic use** only.

Ensure the product is always placed on level ground.

Furniture can be dangerous if incorrectly used. No liability will be accepted for damage or injury caused by incorrect use of this product.

Dos

When you are ready to start, make sure that you have the right tools, plenty of space and a clean, dry area for assembly.

Remove all packaging and banding and place the components carefully on suitable surfaces to prevent damaging or scratching them.

Check the pack and make sure you have all of the parts listed.

Check all screws and bolts are tightened and inspect regularly.

During severe weather conditions, including high winds, rain, hail, thunderstorms, extreme heat and cold temperatures, the product should be stored inside in a cool, dry place.

To best preserve this product, please use a protective cover when your furniture is not in use. We would also recommend using a gazebo or parasol over your furniture during the summer period and prolonged sunny spells. This will help prevent harmful UV rays from damaging and discolouring the material.

Any scratches on the paintwork should be touched up immediately with metal paint to prevent corrosion.

Ensure that the product is clean and dry before storage.

Clean your product with a sponge and warm soapy water then wipe with a clean, dry cloth.

Where instructions as to the; storage, commissioning, installation, use and maintenance of the goods or (if there is none) good trade practice are not followed and a defect arises this will void the 12 month manufacturer's guarantee on the product.

Cushions should be cleaned following the care instruction on the label.

If the set is stored outside then we recommend that cushions are brought inside for storage and protection.

Don'ts

Do not use scourers, abrasives, washing powders, chemical cleaners or any other substances containing abrasives since these substances can damage the product, including the glass panel.

Never tilt the product during use.

Do not strike the product with hard or pointed items.

Do not use power tools to construct this product.

Do not use this product if parts are missing, damaged or worn.

Do not stand or climb onto the product and do not use it as a ladder, as this could lead to it unbalancing and overturning.

Never drag furniture when moving it, always lift it.

Number of people required for assembly

Two people



Time to assemble

20 minutes



Tools required



Tips:

Do NOT fully tighten bolts before all components are connected. Only fully tighten once you are satisfied with the alignment of all components. Do not overtighten bolts.

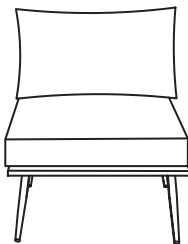
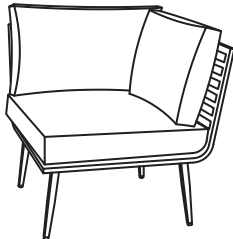
Member Parts

Part No.	Diagram	Name	Qty.
1		Middle Chair	1 PC
2		Corner Chair	1 PC
3		Velcro Band	6 PCS

Velcro Band Assembly

In order to better use the products, the sofa parts are suggested to be connected by Velcro Band with other parts (in other cartons).

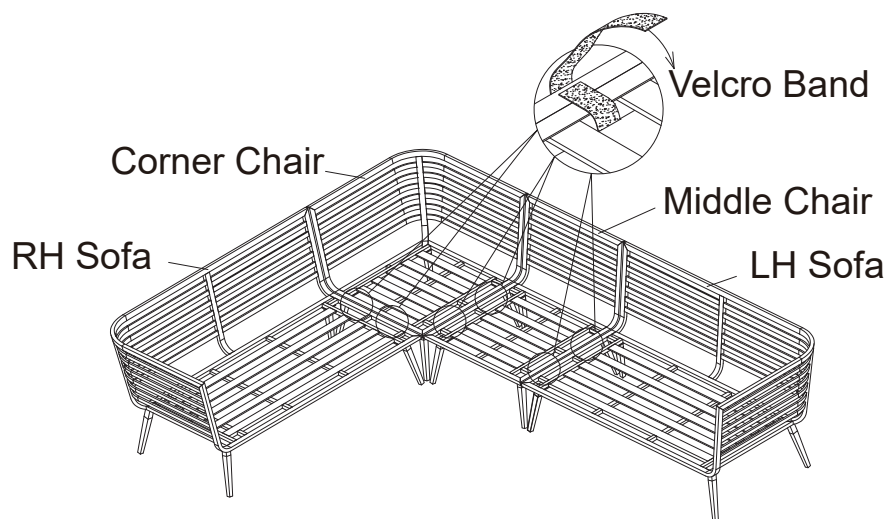



MAYFAIR - 1PC MIDDLE CHAIR, 1PC CORNER CHAIR

Assembly Instructions

Components, fixtures & fittings (not actual size)

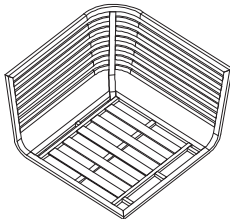
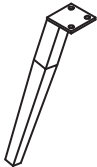
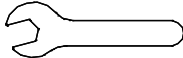
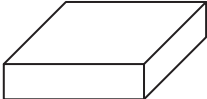
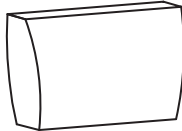
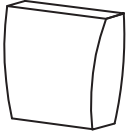
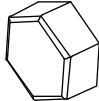
Parts List

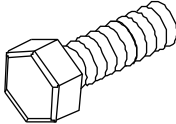
Part No.	Diagram	Qty.	Part No.	Diagram	Qty.
A	 Middle Chair Seat	1 PC	B	 Corner Chair Seat	1 PC
C	 Leg	8 PCS	S1	 Spanner	1 PC
F	 Seat Cushion	2 PCS	G	 Backrest Cushion	2 PCS
H	 Side Cushion	1 PC	F2	 Bolt Head Cap	24 PCS
F3	 Flat Washer	24 PCS	W20	 M6*20mm Bolt	24 PCS

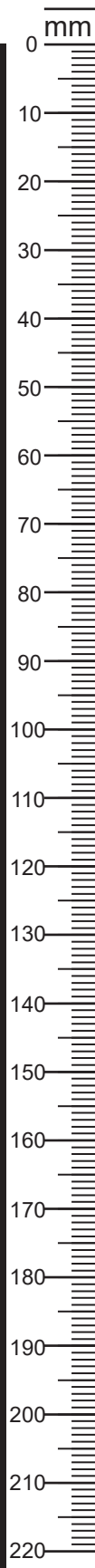

Step by step assembly instructions

Part 1: Middle Chair

Step One

Open the packaging, with the help of another person, place the Middle Chair Seat (A) upside down on a flat, non-abrasive surface to avoid scratching the surface or rim.

Loosely attach the Legs (C) onto the Middle Chair Seat (A) using Flat Washers (F3), Bolts (W20) and Bolt Head Caps (F2).

Only tighten the bolts when all bolts and washers are in place and turn freely. Once you are satisfied with the alignment of the components carefully tighten all bolts using Spanner (S1). Do not over-tighten. Cover each bolt with Bolt Head Cap (F2).

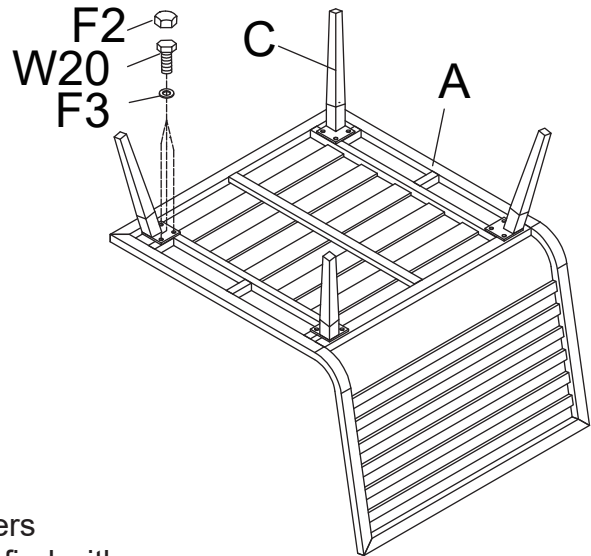

Step Two

With the help of another person, stand the Chair.

Level it by adjustable feet screws.

Place the Seat Cushion (F), Backrest Cushion (G) onto the Seat.

Your Middle Chair is now ready for use.

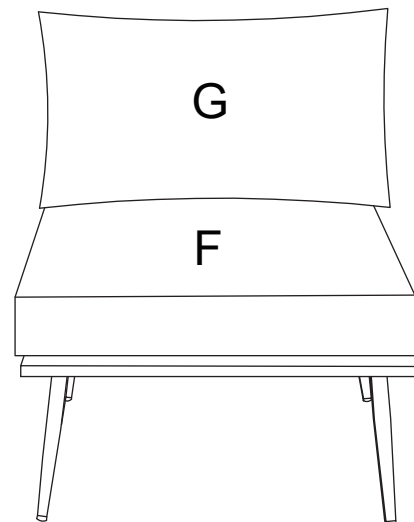

Adjustable Foot Screw

Part 2: Corner Chair

Step One

Open the packaging, with the help of another person, place the Corner Chair Seat (B) upside down on a flat, non-abrasive surface to avoid scratching the surface or rim.

Loosely attach the Legs (C) onto the Corner Chair Seat (B) using Flat Washers (F3), Bolts (W20) and Bolt Head Caps (F2).

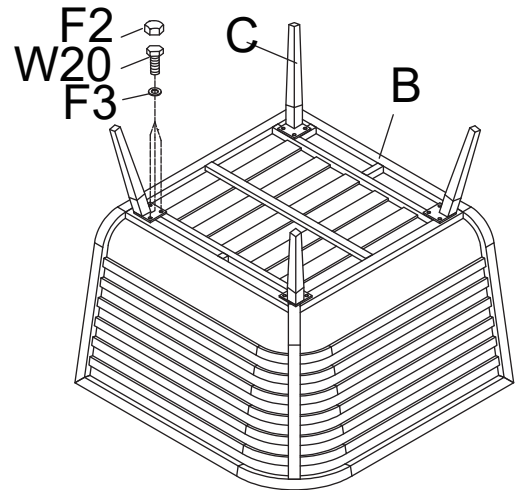

Only tighten the bolts when all bolts and washers are in place and turn freely. Once you are satisfied with the alignment of the components carefully tighten all bolts using Spanner (S1). Do not over-tighten. Cover each bolt with Bolt Head Cap (F2).

Step Two

With the help of another person, stand the Corner Chair.

Level it by adjustable feet screws.

Place the Seat Cushion (F), Backrest Cushions (G) and Side Cushion (H) onto the Seat.

Your Corner Chair is now ready for use.

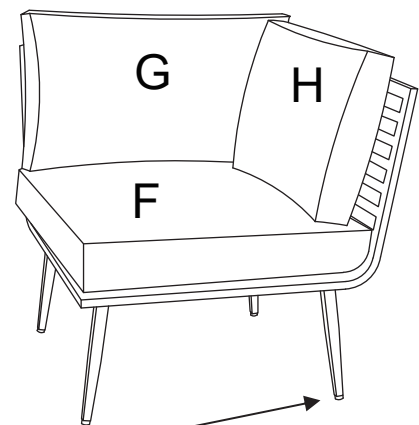

Adjustable Foot Screw

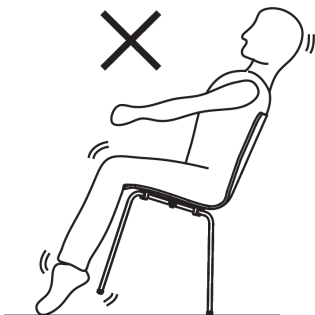

Never tilt the products during use.
Ensure the product is always placed firmly on the ground.

PLEASE KEEP THESE INSTRUCTIONS FOR FUTURE REFERENCE

www.royalcraft.co.uk