

**ASSEMBLY AND OPERATING**  
**INSTRUCTIONS**

**LUGANO PREMIUM POLYCARBONATE**  
**GAZEBO GREY 3x3m**  
**MODEL: LUGGAZ3X3-GREY**



[www.royalcraft.co.uk](http://www.royalcraft.co.uk)

Produced in China for A. Mir & Co., Ltd.  
© A. Mir & Co., Ltd.

**LUGGAZ3X3-GREY**

## **Warning**

1. It is the consumer's responsibility to comply with any relevant local planning requirements.
2. TWO persons are required for assembly. The tools required are a screwdriver, stepladder and other relevant safety items such as gloves. We recommend the use of protective equipment.
3. This gazebo will take at least 3-4 hours to set up. You must allow enough time to complete the assembly. Do not leave it unattended if not fully assembled, even if bolted to the ground.
  - A. Make sure that all components are in the box. Read instructions carefully before starting the assembly.
    - b. Follow all instructions carefully to assure the strength of the gazebo.
    - c. In order to avoid damage to the gazebo and its components, use appropriate tools. Do not use the structure as a support; a stepladder is recommended.
    - d. Check all screws on a regular basis to maintain the solidity of the structure.
    - e. Keep the instructions and parts list for further use.
4. The screws/bolts to anchor to a wooden deck and concrete patio are not included.
5. DO NOT REMOVE THE PROTECTIVE FILM ON THE POLYCARBONATE ROOF PANELS BEFORE INSTALLATION. MAKE SURE TO PUT THE UV PROTECTED SIDE FACING UP TO THE SUN. IT IS A VERY IMPORTANT PROCEDURE; IF NOT FOLLOWED AS DESCRIBED, YOUR ROOF WILL NOT BE COVERED BY THE GUARANTEE

## **Maintenance**

- In the event that your gazebo needs replacement parts, repairs or you require assistance with regards to assembly; please contact our customer sales team [\*\*info@royalcraft.co.uk\*\*](mailto:info@royalcraft.co.uk)
  - For cleaning: Use a mild domestic soap or soft detergent and wash with warm water using a sponge or microfibre fabric. Rinse with clean water.
- To preserve the fabric (curtains) we recommend the use of a UV protector spray like Fabsil this Block the harmful UV rays from damaging the fabric and also will keep the fabric protected from discoloration.















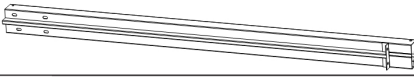







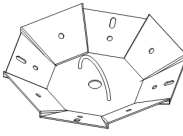

## **Attention**

- Your gazebo has been created for all four seasons and will resist snow accumulations of up to 5kg/m<sup>2</sup>. You will need to remove any excess of snow on the roof at all times.
- The mosquito netting and the curtains must be removed for winter storage.

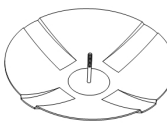
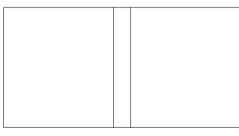
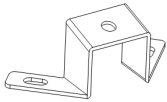
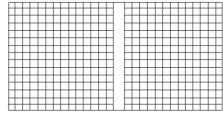
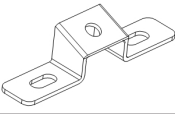
## **EXCLUDED:**

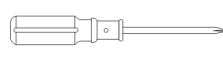
- Damages due to vandalism, abuse and incorrect use of the product are not covered by the warranty
- Damages due to extreme weather conditions such as thunderstorm, hail and high winds are not covered by warranty.

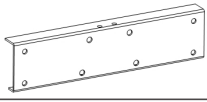
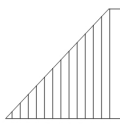
## Parts List

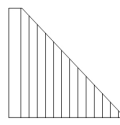
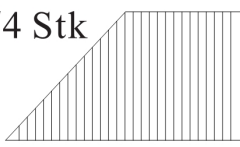
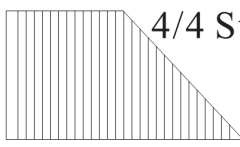
Parts #	Figure	Qty	Parts #	Figure	Qty
A		4	M		4
A1		4	N		4
A2		4	O		96+8
B		4	U		4
C		4	H	M6x12 	48+1
C1		8	H1	M6x12 	66+2
D1		4	H2	M6x35 	8+1
D2		4	H3	M5x15 	40
E		1	H4	M6x12 	8
F		1	W		4
G		4	X		4
I		4	Y		12
J1		4	S		1
J2		4	Z		1
K		4	1/4 Stk		2/4 Stk
L		8	3/4 Stk		4/4 Stk
					

**STEP ONE:**

**BOLTS NEEDED: H1**

CONNECT PART A WITH PART U

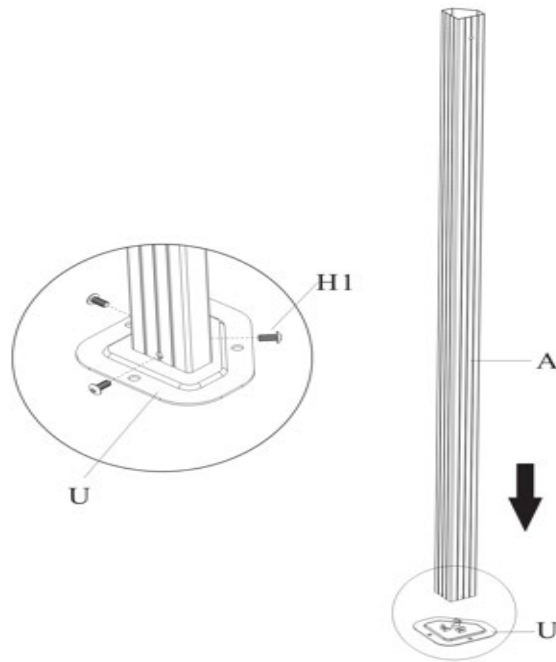

**STEP TWO:**

**BOLTS NEEDED: H**

**2A. SLIDE 6 PART “O” INTO A1 AND 6 PART “O” INTO A2**

**2B. CONNECT A1 AND A2 USING PART K**

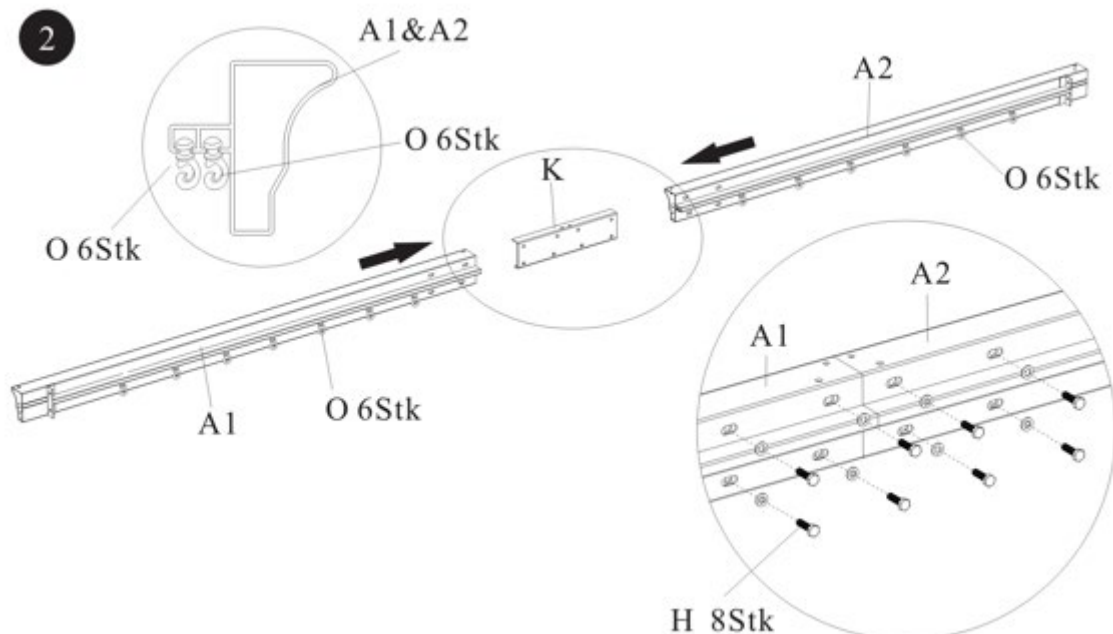

**STEP THREE:**

**BOLTS NEEDED: H, H1, H2**

**3A. CONNECT PARTS A1 AND A2 TO PART A USING H2 SCREWS ON THE OUTSIDE AND H1 SCREWS ON THE INSIDE**

**3B. CONNECT PART L TO PART A AND A1 (A2) USING H SCREWS**

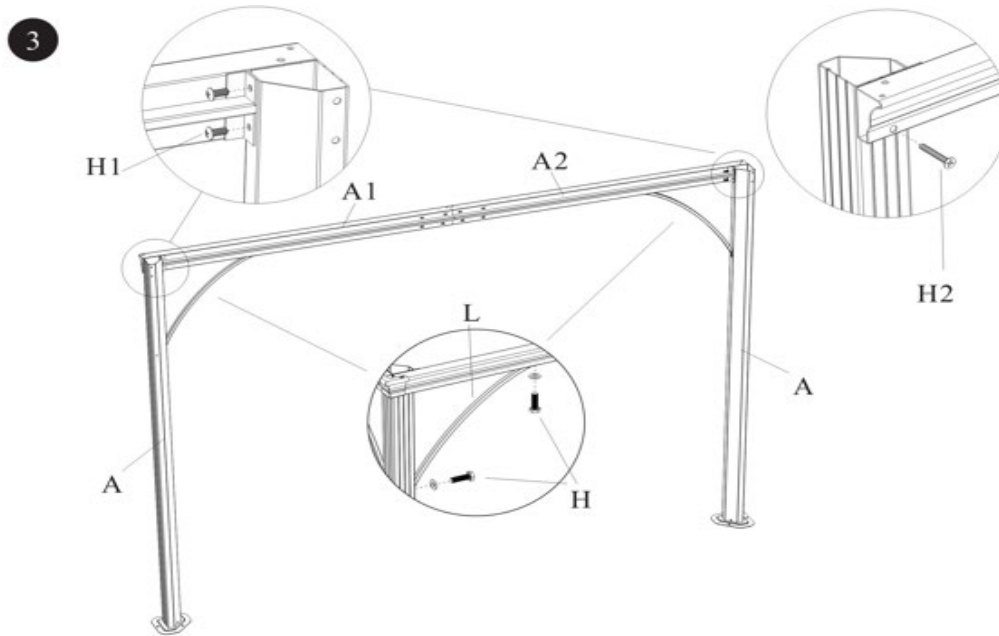

**STEP FOUR:**

**BOLTS NEEDED: H3, H**

REPEAT STEP 3 TO COMPLETE YOUR FOUR SIDES

**4A. CONNECT EACH SIDE USING PART J1 IN EACH CORNER**

**4B. CONNECT PART J2 IN BETWEEN A2 AND A1 USING H3 BOLTS**

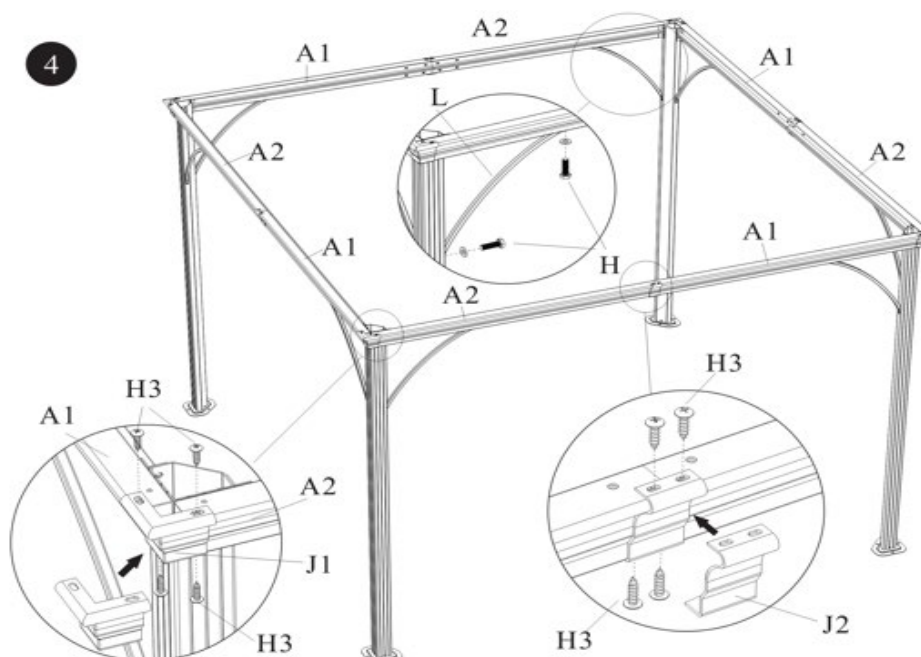

**STEP FIVE:**  
**BOLTS NEEDED: H1**

- 5A. CONNECT PART I TO PART C**  
**5B. CONNECT PART G TO PART B**  
**5C. CONNECT ALL PART C AND B TO PART F (TOP) & E (BOTTOM) ENSURING PART B IS IN ALL CORNERS**

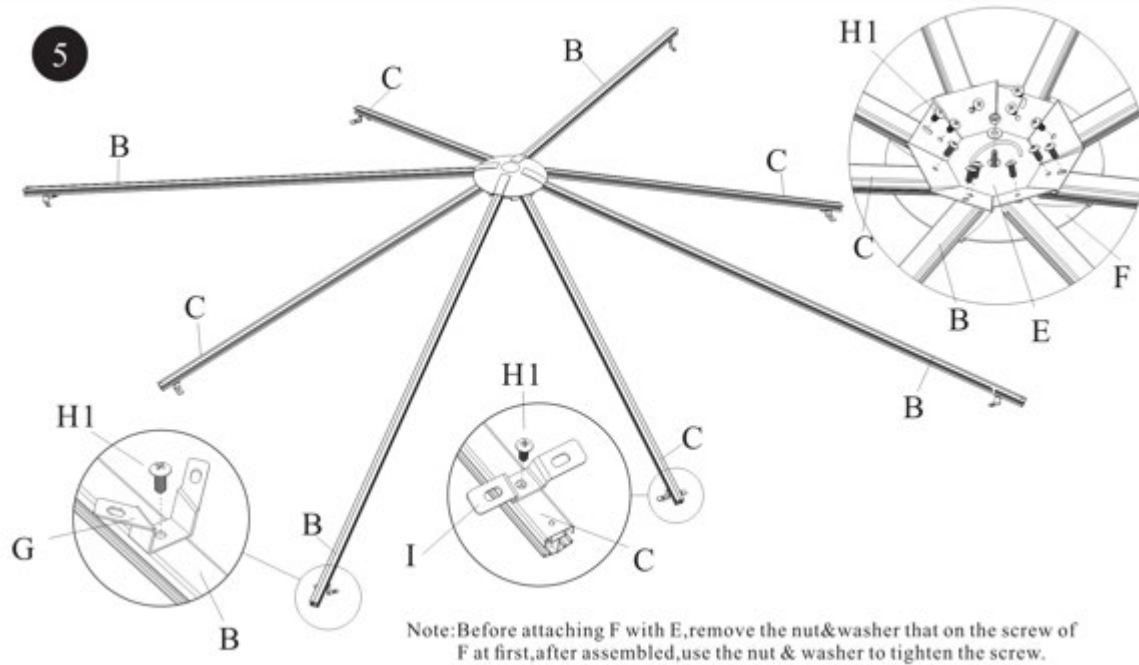

**STEP 6**  
**BOLTS NEEDED: H1**

**CONNECT YOUR ROOF SECTION BUILT IN STEP 5 TO YOUR FRAME WITH PART B IN EACH CORNER USING H1 BOLTS (AS SHOWN IN BELOW DIAGRAM)**

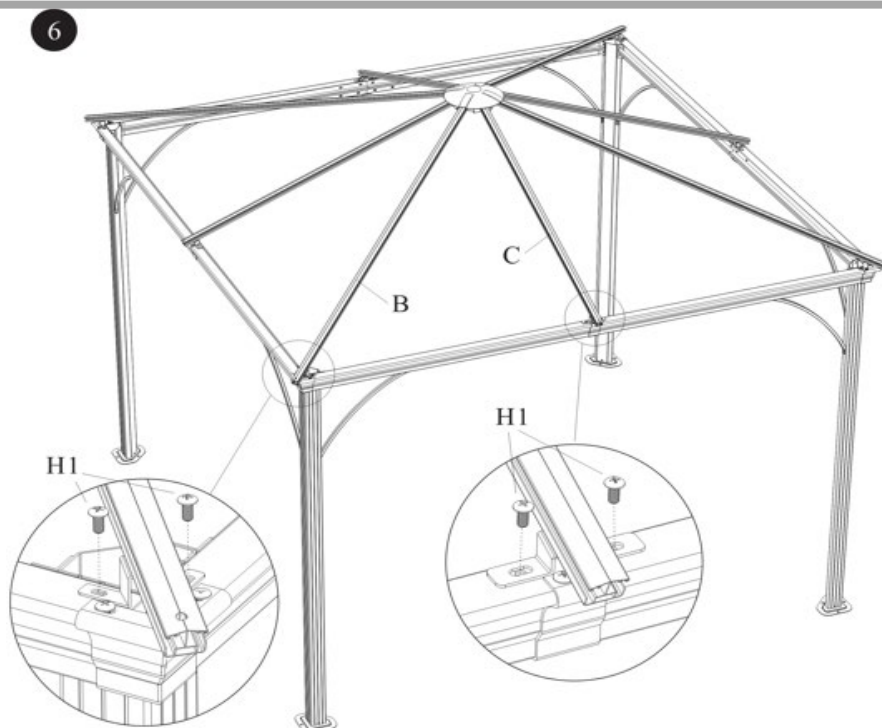



**STEP 7**  
**BOLTS NEEDED: H3, H4**

**7A. SLIDE PANEL 1 AND PANEL 2 INTO YOUR FRAME**

**7B. SLIDE PART C1 TO CONNECT TO PANELS 1 AND 2**

**7C. SLIDE PANELS 3 AND 4 INTO YOUR FRAME**

**7D. SLIDE D2 AND D1 BELOW PANELS 3 AND 4 AND SECURE THEM USING BOLT H4**

**7E. SECURE PART N IN EACH CORNER AND PART M IN THE CENTRE USING H3**

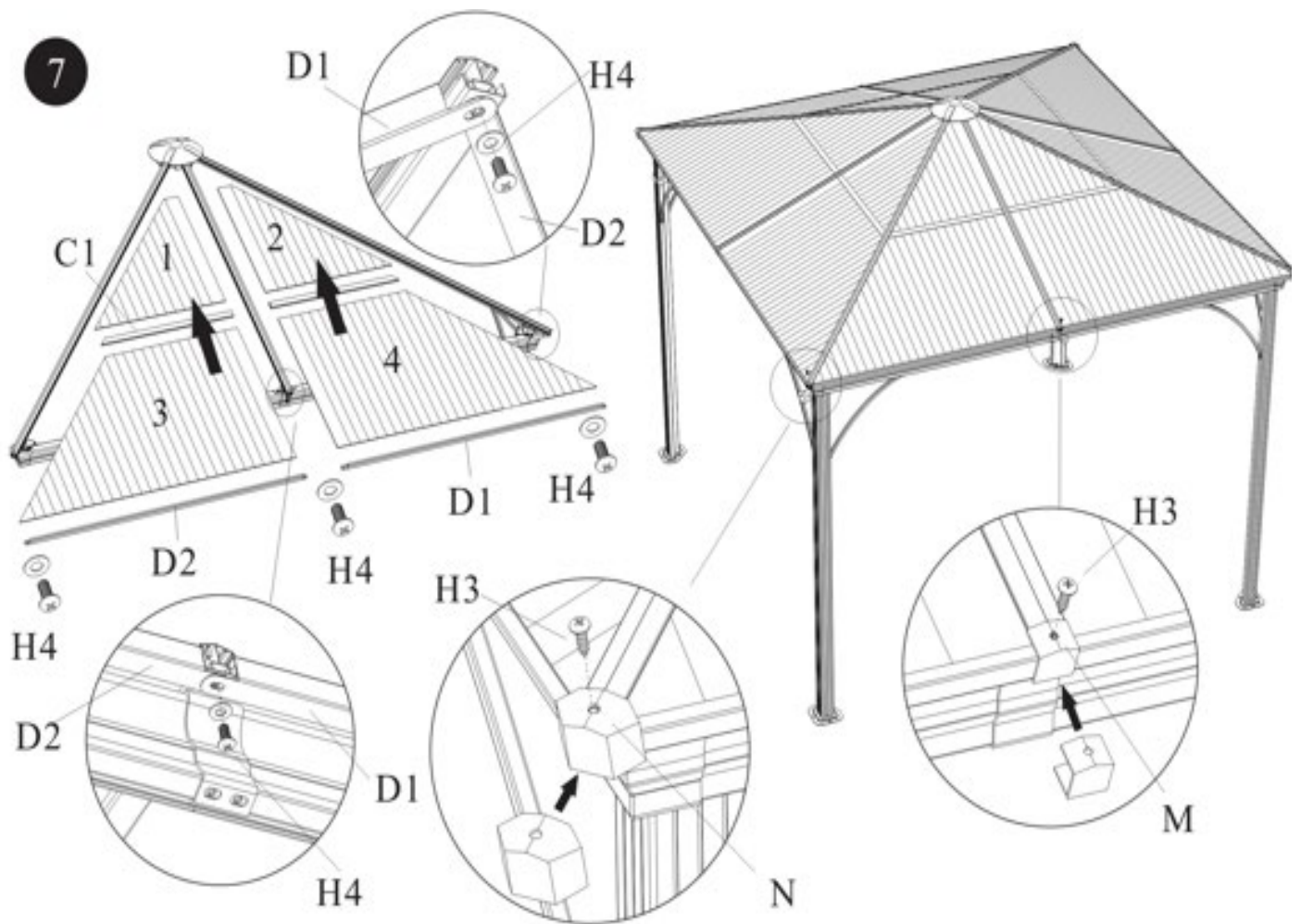

## **STEP 8**

**8A. SLIDE PART X INTO THE INSIDE TRACK**

**8B. SLIDE PART W INTO THE OUTSIDE TRACK**

**8C. SECURE YOUR FRAME INTO THE GROUND USING PART Y (ONLY AVAILABLE FOR GRASS) IF YOU WISH TO SECURE TO CONCRETE YOU WILL NEED TO PURCHASE BOLTS FOR THIS.**

