

Product Size: W63\*D63\*H76cm

**Box of**

**6**



The intended use of this product is for domestic use only.

Important, please retain for future reference.

Read carefully.

### Before you start



#### Warnings

##### IMPORTANT, RETAIN FOR FUTURE REFERENCE READ CAREFULLY

See enclosed instructions for assembly, safety and care information.

Failure to follow the warnings could result in serious injury.

Handle heavy parts with care.

Ensure that this product is fully assembled as illustrated before use.

This product should only be used on firm, level ground.

**Keep small parts out of reach of children.**

Do not stand or climb onto this product.

This product is intended for **domestic use** only.

Ensure the product is always placed on level ground.

Furniture can be dangerous if incorrectly used. No liability will be accepted for damage or injury caused by incorrect use of this product.

#### ✓ Dos

When you are ready to start, make sure that you have the right tools, plenty of space and a clean, dry area for assembly.

Unwrap all packaging materials and place the components on a suitable surface to prevent scratching your product.

Check all contents are present prior to assembly as per the parts list provided. In the event of problems or missing parts, please contact the seller.

Check all screws and bolts are tightened and inspect regularly.

Cover furniture when not in use to add additional protection to your product.

Store all cushions indoors after use as they are not waterproof.

During severe weather conditions, including high winds, rain, hail, thunderstorms, extreme heat and cold temperatures, the product should be stored inside in a cool, dry place.

To best preserve the synthetic rattan, please use a protective cover when your furniture is not in use. We would also recommend using a gazebo or parasol over your furniture during the summer period and prolonged sunny spells. This will help prevent harmful UV rays from damaging and discolouring the material.

Ensure that the product is clean and dry before storage.

Clean your product with a sponge and warm soapy water then wipe with a clean, dry cloth.

Cushions should be cleaned following the care instruction on the label.

Where instructions as to the; storage, commissioning, installation, use and maintenance of the goods or (if there is none) good trade practice are not followed and a defect arises this will void the 12 month manufacturer's guarantee on the product.

#### X Don'ts

Never tilt the chair during use.

Do not stand or climb onto the product.

Do not use power tools to construct this product.

Do not sit or lean onto the arms of this product.

Do not use this product if parts are missing, damaged or worn.

Do not use scourers, abrasives, washing powders, chemical cleaners or any other substances containing abrasives since these substances can damage the product.

Do not use this product as a ladder as this could lead to the product becoming unbalanced and overturning.

Do not place very hot or very cold items on this product surface.

Never drag furniture when moving it, always lift it.

#### Number of people required for assembly

One person



#### Time to assemble



20 minutes

#### Tools required



#### Tips:

**It is best not to fully tighten the nuts and bolts until they are all correctly located. Only carefully tighten them when you are satisfied with the alignment of all components.**







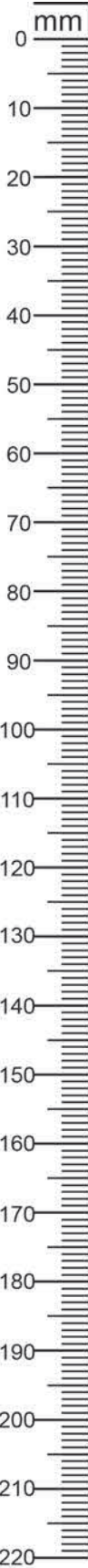

**Be careful not to overtighten.**

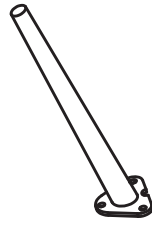
# Aspen Rope Chair - Box of 6 Assembly Instructions

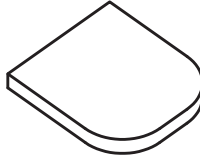
Components, fixtures & fittings (not actual size)

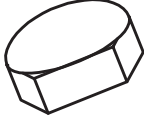

## Parts List

Part No.	Diagram	Qty.	Part No.	Diagram	Qty.
A	 Seat	6 PCS	B	 Front Leg	12 PCS
C	 Rear Leg	12 PCS	D	 Seat Cushion	6 PCS
E	 Backrest Cushion	6 PCS	F	 Bolt Head Cap	72 PCS
W25	 M6*25mm Bolt	72 PCS	S	 Spanner	1 PC
F3	 Flat Washer	72 PCS	F2	 Spring Washer	72 PCS

# Aspen Rope Chair - Box of 6

## Assembly Instructions

Please note the diagram is for reference only, it may not fully represent the actual appearance of the parts.

### Step by step assembly instructions

#### Step One

Place the Seat (A) upside down onto a soft surface to avoid the scratches. Attach the Front Legs (B) and Rear Legs (C) onto the bottom of the Seat (A) using Flat Washers (F3), Spring Washers (F2) and Bolts (W25).

Once you are satisfied with the alignment of all components, carefully tighten all bolts using Spanner (S).

Cover each Bolt Head with Bolt Head Cap (F).

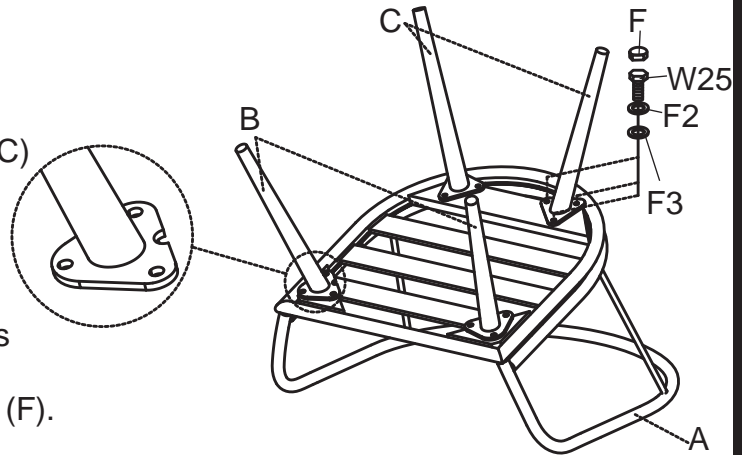

#### Step Two

Stand the Chair in the upright position. Place the Seat Cushion (D) and Backrest Cushion (E) onto the chair Seat. Level the chair with Adjustable Feet Screw. Your Chair is now ready for use.

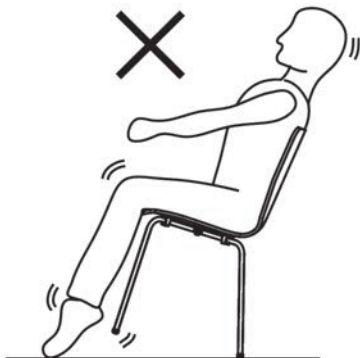
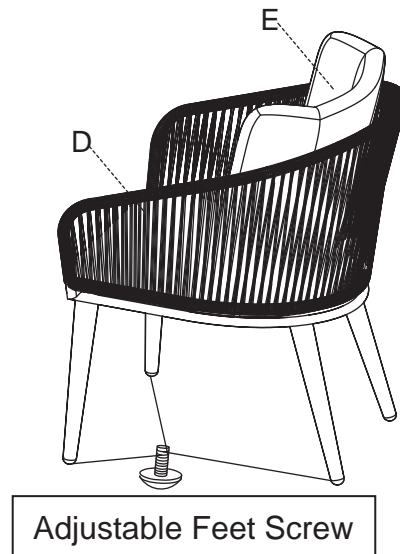

Never tilt the Chair during use. Ensure the product is always placed firmly on the ground.

**PLEASE KEEP THESE INSTRUCTIONS FOR FUTURE REFERENCE**