

Product size:  
D118\*H72cm  
D150\*H72cm

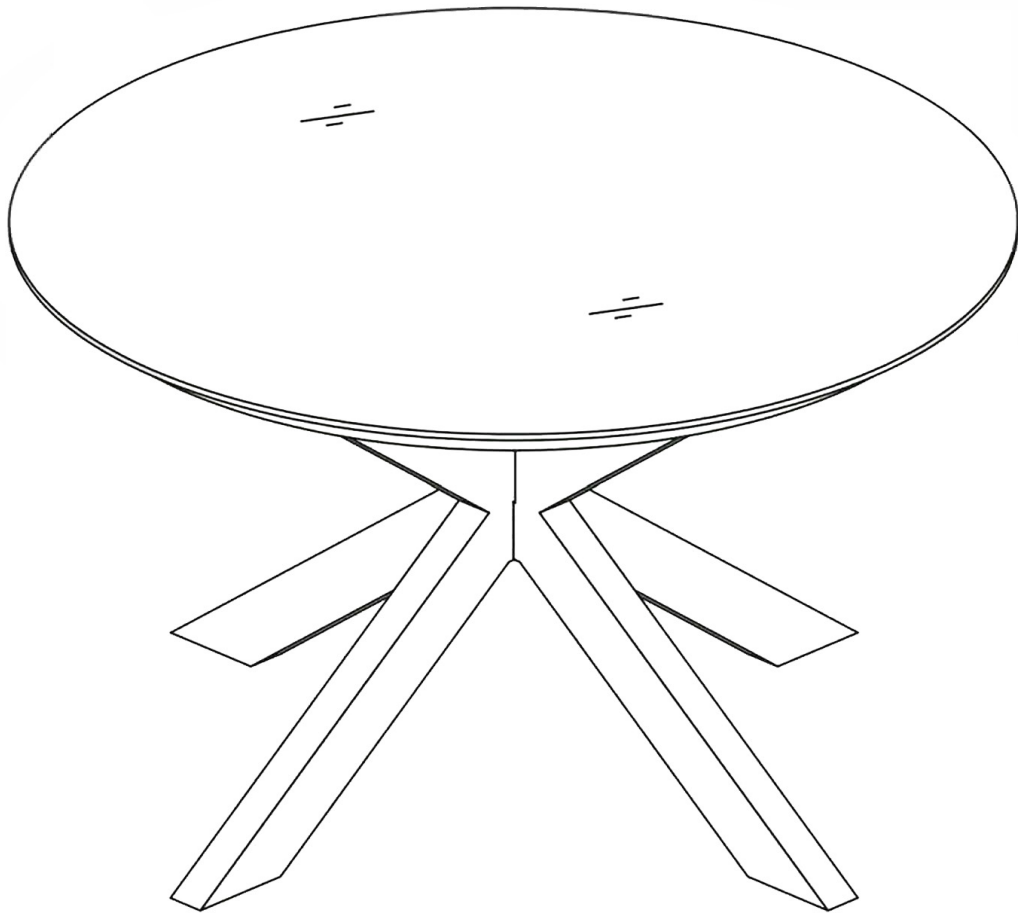

The intended use of this product is for domestic use only.

Important, please retain for future reference.

Read carefully.

# Spray Stone Glass

## 2022 Revised Care & Maintenance Instructions

### Important Notice:

This table top is made with a spray stone glass top. The characteristic of the spray stone layer is not fully dirt-proof as a normal glass top table. The spray stone table top consists of two layers: The bottom layer of safety glass is covered with a thin top layer of bonded stone chips (ground natural stone and high quality resin) and is specially designed for outdoor use. This spray stone furniture has a protective layer applied that protects your table from dirt and grease. However, over time the top layer may also become detached from the table top so it is important that regular maintenance and cleaning is completed.

### Regular Maintenance And Cleaning Of The Table:

It is best to clean the table regularly with lukewarm water only using a soft cloth or sponge. When accidental spillages occur from any types of wine, beverages, liquid or food, including juices, condiments or oil-based products, please immediately use a soft cloth or sponge to dab off the excess and then clean gently with lukewarm water always wringing your sponge or cloth thoroughly. The longer you wait to clean the table, the more difficult it becomes to remove any stains. Make sure that no soap residue is left behind.

Do not use any abrasive cleaning products or items and avoid rubbing the table top. Do not clean the table with a high pressure cleaner or aggressive cleaning products as these can cause hairline cracks where dirt can accumulate and cause the furniture to turn white.

Do not place very hot, very cold, greasy or oily items directly onto the surface. Please use place mats and coasters for the dining duration. If you leave any items including coasters, tableware, food or drinks on the table top for a long period of time, a permanent chemical reaction may occur causing a white imprinted stain. This reaction in turn will cause irreparable damage, therefore it is important to remove any decor and accessories regularly from your table top.

It is not necessary to use a furniture cover for the table top as covering it for a long period of time may cause the table top coating to peel. If you choose to cover your table, only use a Royalcraft branded furniture cover.

To revamp the textured look on the table top, a speckled paint product can be used which can be purchased from all good DIY stores.

=====

**Please retain for future reference. Read carefully.**

# Aspen 118cm/150cm Table

## Assembly Instructions

### Before you start



#### Warnings

##### **IMPORTANT, RETAIN FOR FUTURE REFERENCE READ CAREFULLY**

See enclosed instructions for assembly, safety and care information.

Failure to follow the warnings could result in serious injury.

Handle heavy parts with care.

Ensure that this product is fully assembled as illustrated before use.

This product should only be used on firm, level ground.

**The product contains small parts which could pose a risk to young children. Keep small parts out of reach of children.**

Do not stand or climb onto this product.

This product is intended for **domestic use** only.

Ensure the product is always placed on level ground.

Furniture can be dangerous if incorrectly used. No liability will be accepted for damage or injury caused by incorrect use of this product.

**A parasol base with suitable weight must be used to support your parasol to avoid damage to your furniture.**



#### Dos

When you are ready to start, make sure that you have the right tools, plenty of space and a clean, dry area for assembly.

Unwrap all packaging materials and place the components on a suitable surface to prevent scratching your product.

Check all contents are present prior to assembly as per the parts list provided. In the event of problems or missing parts, please contact the seller.

Check all screws and bolts are tightened and inspect regularly.

During severe weather conditions, including high winds, rain, hail, thunderstorms, extreme heat and cold temperatures, the product should be stored inside in a cool, dry place.

We recommend using a gazebo or parasol over your furniture during the summer period and prolonged sunny spells. This will help prevent harmful UV rays from damaging and discolouring the material.

Ensure that the product is clean and dry before storage.

Clean your product with lukewarm water only using a sponge or a soft cloth.

Where instructions as to the; storage, commissioning, installation, use and maintenance of the goods or (if there is none) good trade practice are not followed and a defect arises this will void the 12 month manufacturer's guarantee on the product.

#### X Don'ts

Do not use a furniture cover for the table top as covering it for a long period of time may cause the table top coating to peel. If you choose to cover your table, only use a Royalcraft branded furniture cover.

Do not use scourers, abrasives, washing powders, chemical cleaners or any other substances containing abrasives since these substances can damage the product, including the spray stone glass.

Do not place very hot, very cold, greasy or oily items directly onto the surface. Please use place mats and coasters for the dining duration.

Do not leave items including coasters, tableware, food or drinks on the table top for long periods of time, a permanent chemical reaction may occur causing a white imprinted stain. This reaction in turn will cause irreparable damage.

Do not clean the table with a high pressure cleaner or aggressive cleaning products as these can cause hairline cracks where dirt can accumulate and cause the furniture to turn white.

Do not use the table as a chopping surface.

Do not strike the table with hard or pointed items.

Do not sit or lean on the table.

Do not use power tools to construct this product.

Do not use this product if parts are missing, damaged or worn.

Do not stand or climb onto the product and do not use it as a ladder as this could lead to it unbalancing and overturning.

Never drag furniture when moving it, always lift it.

#### Time to assemble

#### Number of people required for assembly

Two People



30 minutes

#### Tools required



#### Tips: .







**It is best not to fully tighten the nuts and bolts until they are all correctly located. Only carefully tighten them when you are satisfied with the alignment of all components.**

**Be careful not to overtighten.**

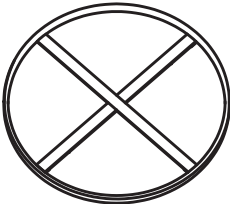
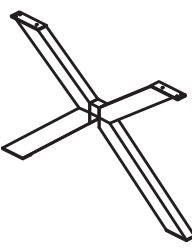
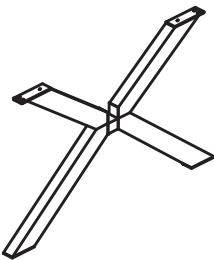
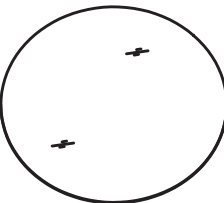
**To revamp the textured look on the table top, a speckled paint product can be used which can be purchased from all good DIY stores.**

# Aspen 118cm/150cm Table Assembly Instructions

Components, fixtures & fittings (not actual size)

Parts List					
Part No.	Diagram	Qty.	Part No.	Diagram	Qty.
A	 Table Top	1 PC	B	 Upper Table Leg	1 PC
C	 Bottom Table Leg	1 PC	D	 Glass Top	1 PC
W20	 M6*20mm Bolt	8 PCS	F3	 Flat Washer	8 PCS
F2	 Spring Washer	8 PCS	G	 Bolt Head Cap	8 PCS
S	 Spanner	1 PC			

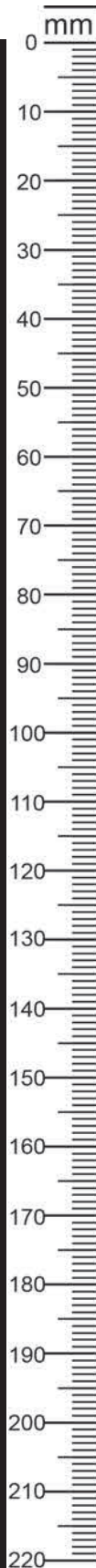

# Aspen 118cm/150cm Table

## Assembly Instructions

### Step by step assembly instructions

#### Step One

With the help of another person, open the cartons, place the Glass Top (D) onto a safe place at first.

With the help of another person, place Table Top (A) upside down on a flat, non-abrasive surface to avoid scratching the table surface or rim.

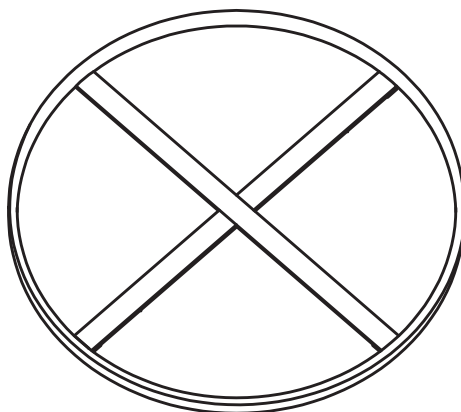

#### Step Two

With the help of another person, place Table Leg (C) onto the Table Leg (B).

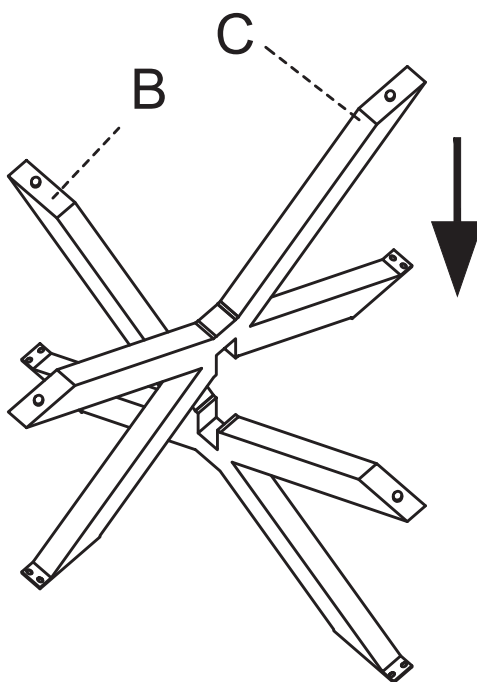

# Aspen 118cm/150cm Table

## Assembly Instructions

### Step Three

Locate the assembly position on the bottom side of the Table Top (A).

Attach the Table Legs (B) and (C) onto the assembly position, aligning holes in each part.

Loosely attach the Table Legs to the Table Top (A) using Flat Washers (F3), Spring Washers (F2) and Bolts (W20).

Only tighten the bolts when all bolts and washers are in place and turn freely. Once you are satisfied with the alignment of the components, carefully tighten all bolts using Spanner (S). Do not over-tighten.

Cover each bolt with Bolt Head Cap (G).

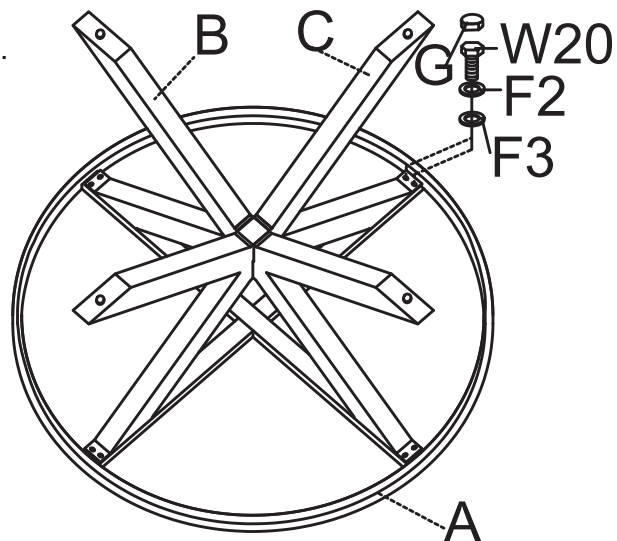

### Step Four

With the help of another person, stand the Table Frame in the upright position.

Carefully place the Glass Top (D) onto the Table Frame.

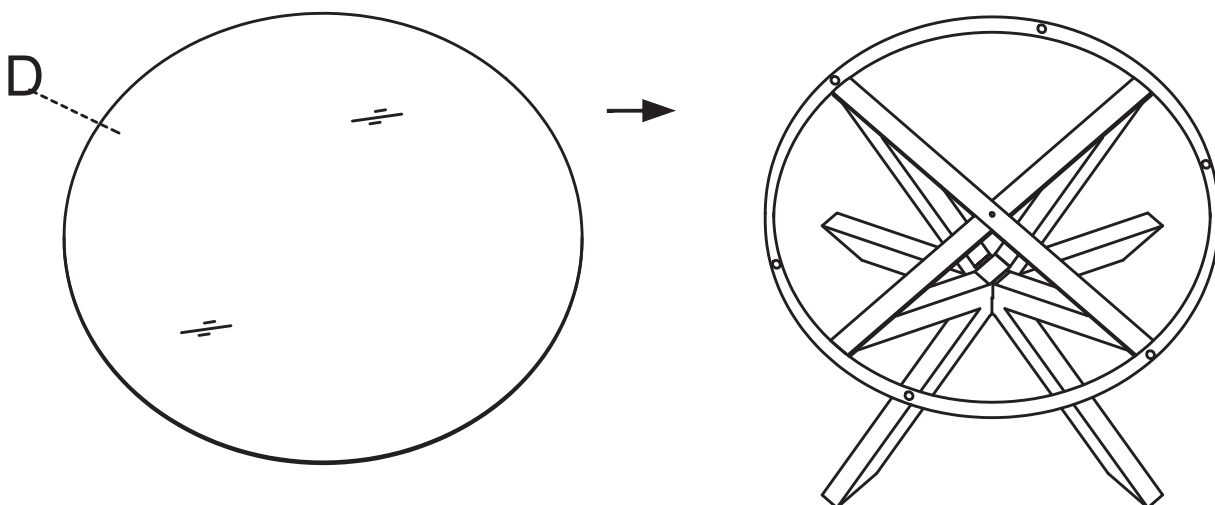

# Aspen 118cm/150cm Table

## Assembly Instructions

### Step Five

With the help of another person, carefully turn over the table and place it in the upright position. Level the table with the Adjustable Feet Screw on the bottom of the Table Legs. Your table is now ready for use.

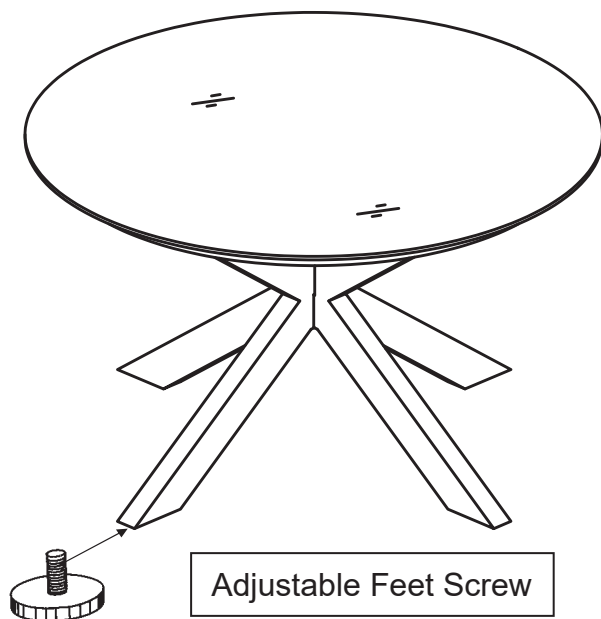

**PLEASE KEEP THESE INSTRUCTIONS FOR FUTURE REFERENCE**