

Product size:
Dia300*H255 cm



The intended use of this product is for domestic use only.

Important, please retain for future reference.

Read carefully.

www.royalcraft.co.uk



3m Deluxe Pedal Operated Rotational Cantilever Parasol with Cross Stand Assembly Instructions

Before you start



Warnings

IMPORTANT, RETAIN FOR FUTURE REFERENCE READ CAREFULLY

See enclosed instructions for assembly, safety and care information.

Failure to follow the warnings could result in serious injury.

Handle heavy parts with care.

Ensure that this product is fully assembled as illustrated before use.

This product is intended for **domestic** use only.

This product should only be used on firm, level ground.

The product contains small parts which could pose a risk to young children. Keep small parts out of reach of children.

Keep hands away from folding mechanism and moving parts to prevent possible injury.

Never use or open this parasol without a suitable base set in place.

Furniture can be dangerous if incorrectly used. No liability will be accepted for damage or injury caused by incorrect use of this product.



Dos

When you are ready to start, make sure that you have the right tools, plenty of space and a clean, dry area for assembly.

Unwrap all packaging materials and place the components on suitable surface to prevent scratching your product.

Check all contents are present prior to assembly as per the parts list provided. In the event of problems or missing parts, please contact the seller.

Check all screws and bolts are tightened and inspect regularly.

Use a furniture cover to protect your product when not in use.

Ensure your item is closed when not in use.

During severe weather conditions, including high winds, rain, hail, thunderstorms, extreme heat and cold temperatures, the product should be taken down and stored inside in a cool, dry place.

Ensure that the product is clean and dry before storage.

Wipe with a damp sponge and a little warm soapy water, then dry with a clean, dry cloth. The product must be thoroughly dry to prevent mildew and mold stains from forming.

Where instructions as to the; storage, commissioning, installation, use and maintenance of the goods or (if there is none) good trade practice are not followed and a defect arises this will void the 12 month manufacturer's guarantee on the product.

Don'ts

Do not stand or climb onto the product.

Do not use power tools to construct this product.

Do not sit or lean onto the rims of this product.

Do not use this product if parts are missing, damaged or worn.

Do not leave the parasol open when not in use or unattended.

Do not leave the parasol open when there is a risk of high winds, as damage will occur to its structure.

Do not use scourers, abrasives, washing powders, chemical cleaners or any other substances containing abrasives since these substances can damage the product.

Do not use solvent-based cleaners or detergents as they can bleach or damage the product.

Never use a pressure hose or washer to clean the product.

Never drag furniture when moving it, always lift it.

Never move this parasol when fully assembled.

To avoid damage do not allow water to collect or "pool" on the fabric.

Number of people required for assembly

Two people



Time to assemble



30 Minutes

Tools required



It is recommended that before moving heavy objects to a new location they should be completely disassembled to avoid personal injury or damage to the furniture. Please be careful to retain all fittings when doing this.





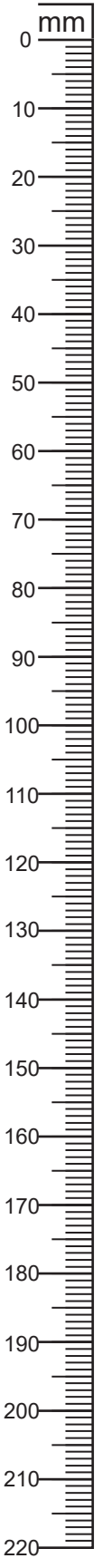

A competent person should carry out assembly. No liability will be accepted for damage or injury caused by incorrectly installed or assembled furniture.

www.royalcraft.co.uk

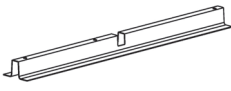
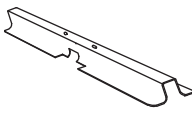
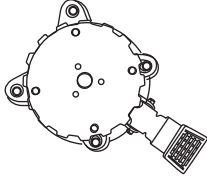
3m Deluxe Pedal Operated Rotational Cantilever Parasol with Cross Stand Assembly Instructions

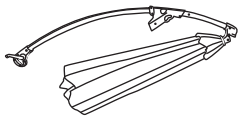
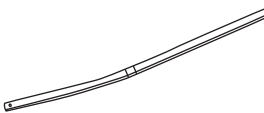

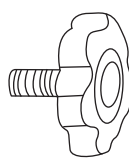
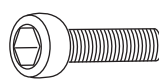
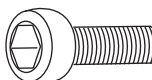
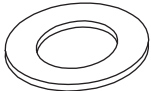
Components, fixtures & fittings (not actual size)

Parts List					
Part No.	Diagram	Qty.	Part No.	Diagram	Qty.
A	 Bottom Cross	1 PC	B	 Upper Cross	1 PC
C	 Swivel	1 PC	D	 Stand Pole	1 PC
E	 Parasol Canopy	1 PC	F	 Pole	1 PC
G	 Handle	1 PC	H	 Knob	2 PCS
N18	 M8*18mm Bolt	4 PCS	N16	 M8*16mm Bolt	4 PCS
F3	 Washer	8 PCS	AK	 Allen Key	1 PC



3m Deluxe Pedal Operated Rotational Cantilever Parasol with Cross Stand Assembly Instructions

Care & Maintenance

CANOPY CARE INSTRUCTIONS:

- Simply clean the parasol canopy with a soft brush and mild detergent.
- Do not machine wash.
- Do not iron.
- Air-dry the canopy thoroughly before storing for extended periods of time. Make sure the canopy is completely open during drying process to prevent shrinkage.
- If the painted finish gets chipped or scratched, therefore exposing the bare material beneath. It is advisable to remove any surface rust and treat with a suitable touch up paint.
- If the parasol is not to be used for long periods during the winter, store inside or under a suitable cover. Before putting into storage, ensure all of the items are clean and dry.

DANGER: Keep children out of the assembly area during assembly.

WARNING: Read the entire instructions before beginning and follow the steps outlined. Failure to assemble and install as instructed could result in the parasol tipping over causing personal injury and/or property damage.

WARNING: To prevent damage to the canopy, open the parasol facing the opposite direction that the wind is blowing.

WARNING: Do not use this parasol during periods of high winds and rain. Failure to do so may result in personal injury and/or damage.

CAUTION: Assemble and use parasol on a flat surface.

CAUTION: Placement of the parasol over or near a swimming pool can cause premature fading of the canopy. This is not covered under the warranty.

CAUTION: Close the parasol and use the canopy ties when parasol is not in use.

CAUTION: Schematics in this manual are for assembly and operation illustration only. They may differ from the parasol's actual appearance.

When raising the parasol please be aware of overhanging power cables, laundry lines and overhanging branches.

Care must be taken when opening or closing the parasol to ensure that you do not trap or pinch your fingers or clothing.

WARNING

This product is not a toy. Children are not allowed to use this product without adult's guidance or presence.

www.royalcraft.co.uk

3m Deluxe Pedal Operated Rotational Cantilever Parasol with Cross Stand Assembly Instructions

Step by step assembly instructions

Step One

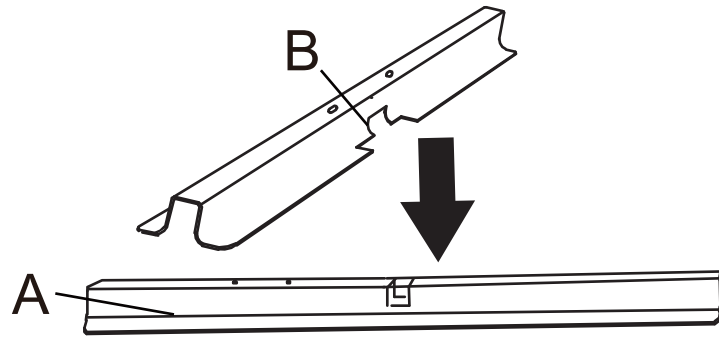

Step Two

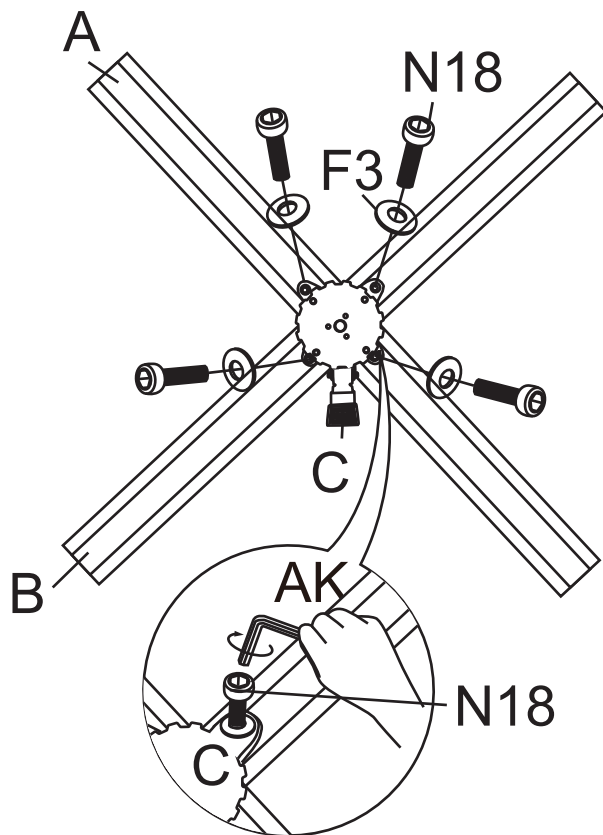

3m Deluxe Pedal Operated Rotational Cantilever Parasol with Cross Stand

Assembly Instructions

Step Three

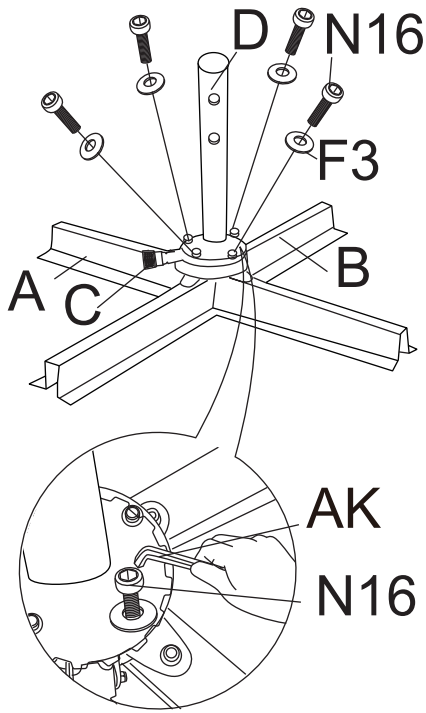

Step Four

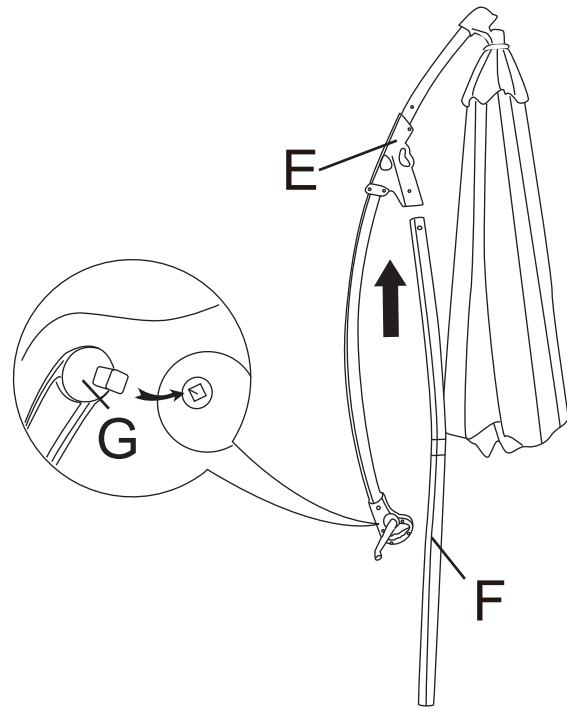

Step Five

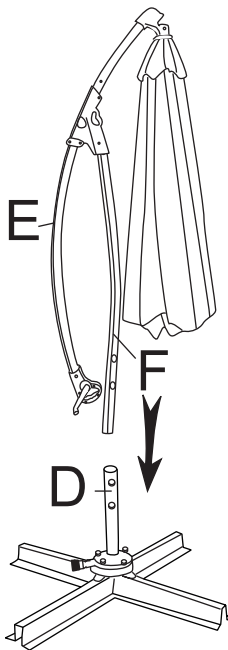

Step Six

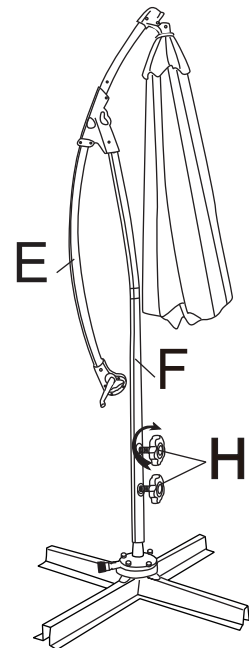

WARNING

Please take care to keep fingers away from moving parts and crank rotating area to prevent possible injury.

3m Deluxe Pedal Operated Rotational Cantilever Parasol with Cross Stand Assembly Instructions

Step Seven

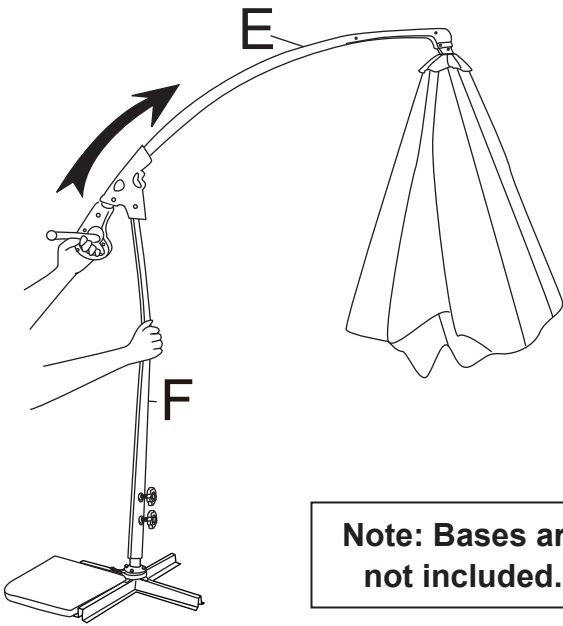

Note: Bases are not included.

Step Eight

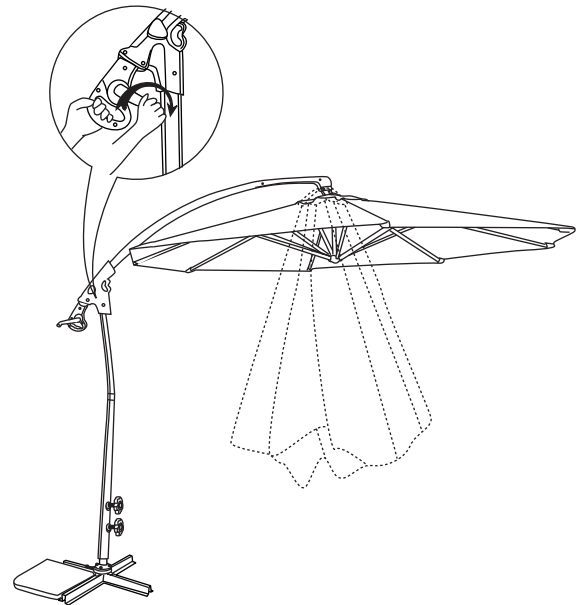

Step Nine

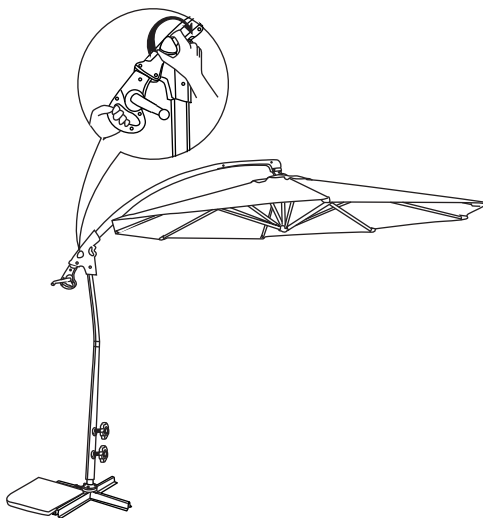

Step Ten

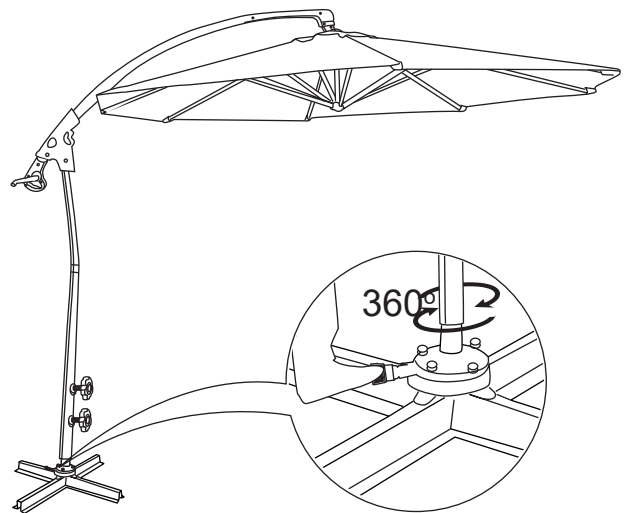

Suitable parasol bases should be used together with this parasol!

PLEASE KEEP THESE INSTRUCTIONS FOR FUTURE REFERENCE

www.royalcraft.co.uk