

C965 V5.0 DISPLAY

User Manual

Dillenger C965 Display - V5.0

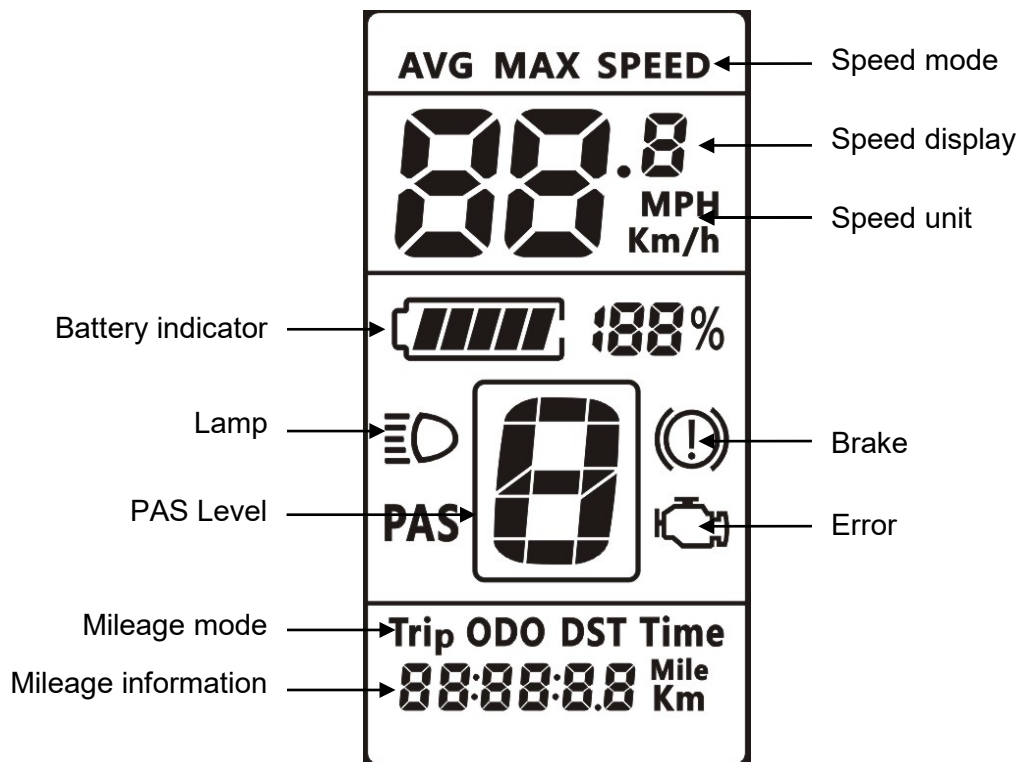

Contents

Details.....	3
Features.....	4
LCD Instructions.....	5
Functional Description.....	6
Basic Parameter Settings.....	9
Password Parameter Settings.....	11
Error Code Definitions.....	18
Assembly Instructions.....	19
Assistance Level Instructions.....	21

Details

Electrical Parameters

- 24V/36V/48V battery supply
- Rated operating current : 10mA
- Max operating current : 30mA
- Off leakage current < 1uA
- Max output current to controller : 50mA
- Operating temperature : -20 °C to 70 °C
- Storage temperature : -30 °C to 80 °C

Dimensions & Material

Product shell is ABS, transparent window is made with high strength Acrylic, the stiffness equals tempered glass.

Dimensions

L90mm*W54mm*H13.3mm



Features

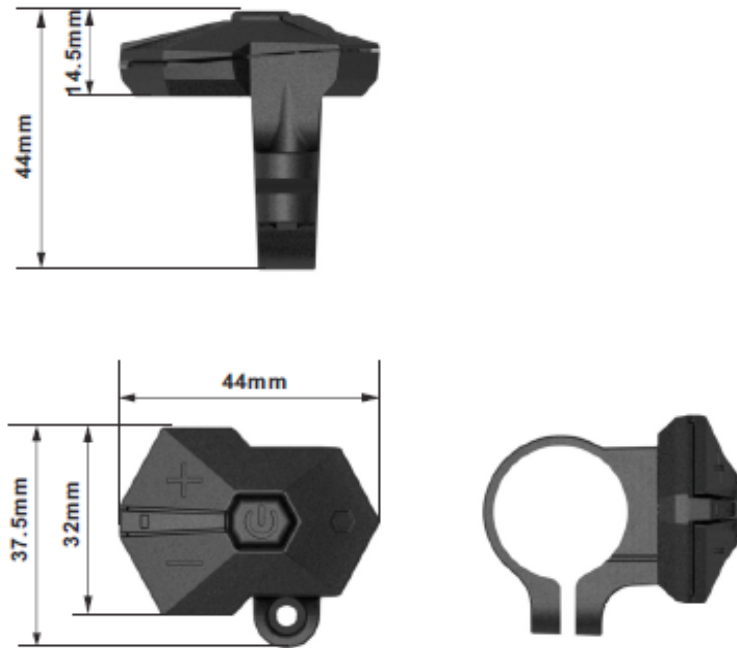

Features

- Ergonomic external button design
- Speed display: AVG SPEED, MAX SPEED, SPEED
- Kilometer / Mile: can be changed to imperial or metrical
- Battery indicator
- The brightness of the backlight: adjustable, 5 settings
- 9-level Assist: 3-level/5-level/9-level, optional.
- Mileage indicator: Odometer/Trip distance/ Riding time/Power
- Error code indicator
- Parameter settings: including assist level numbers/ Wheel diameter / Speed limit / etc

LCD instructions

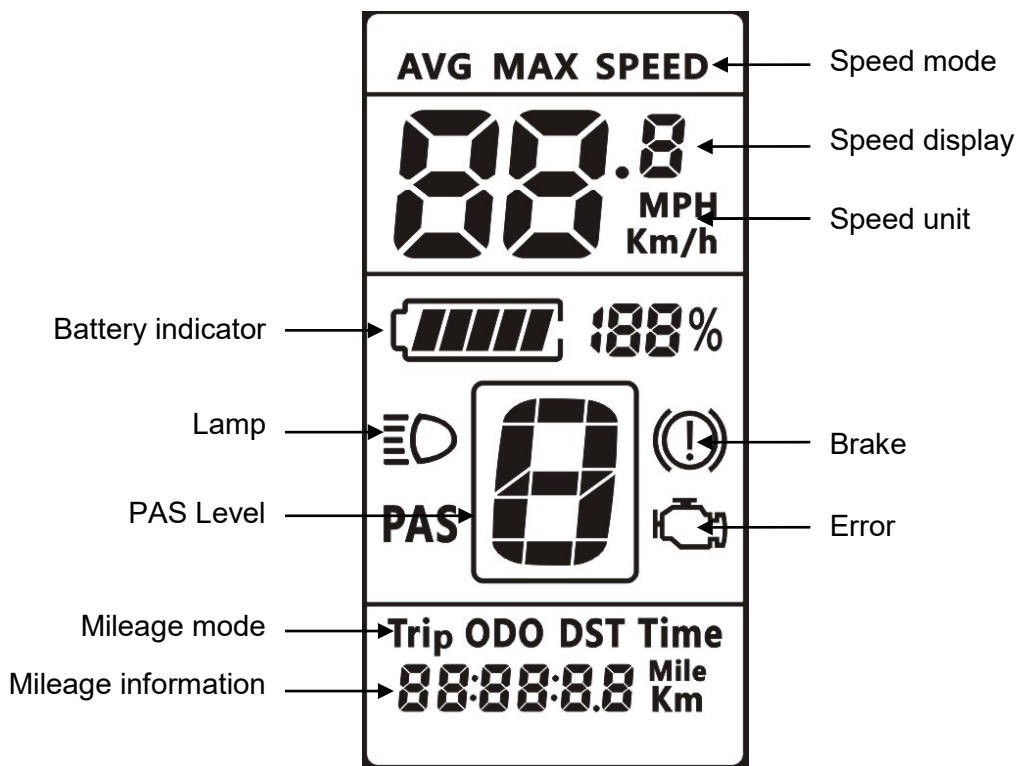

Functional Description

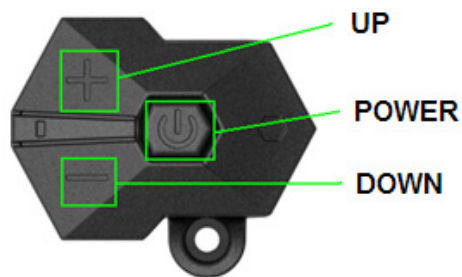

Power On/Off

Press and hold Power button for 1 second to turn on/off the display. The display will automatically shut down when it's not operated & ridden for n minutes (n can be 0~9).

Assist level

Shortly press the UP or DOWN button to change the assist level, choose 0 for no assist. The levels can be adjusted while riding.

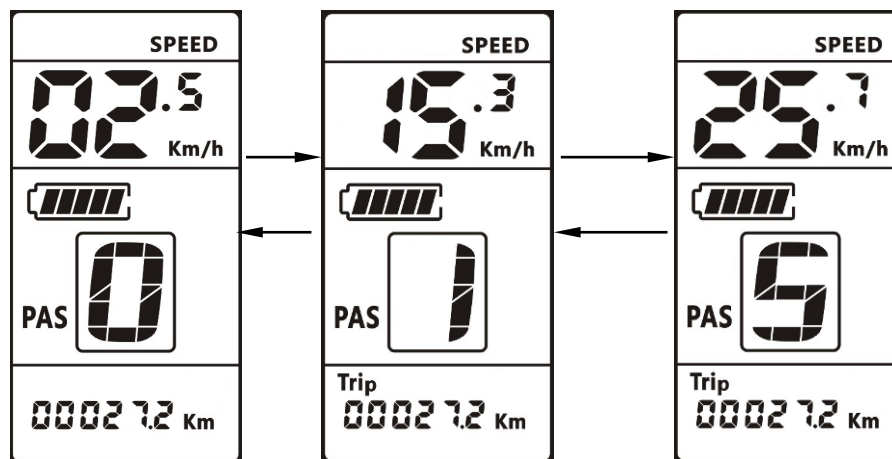

Assist levels

Speed mode and Mileage mode

Shortly press the POWER button to change the speed mode and the mileage mode

Trip->Time- >ODO->Power-> AVG Speed->MAX Speed (see picture on next page).

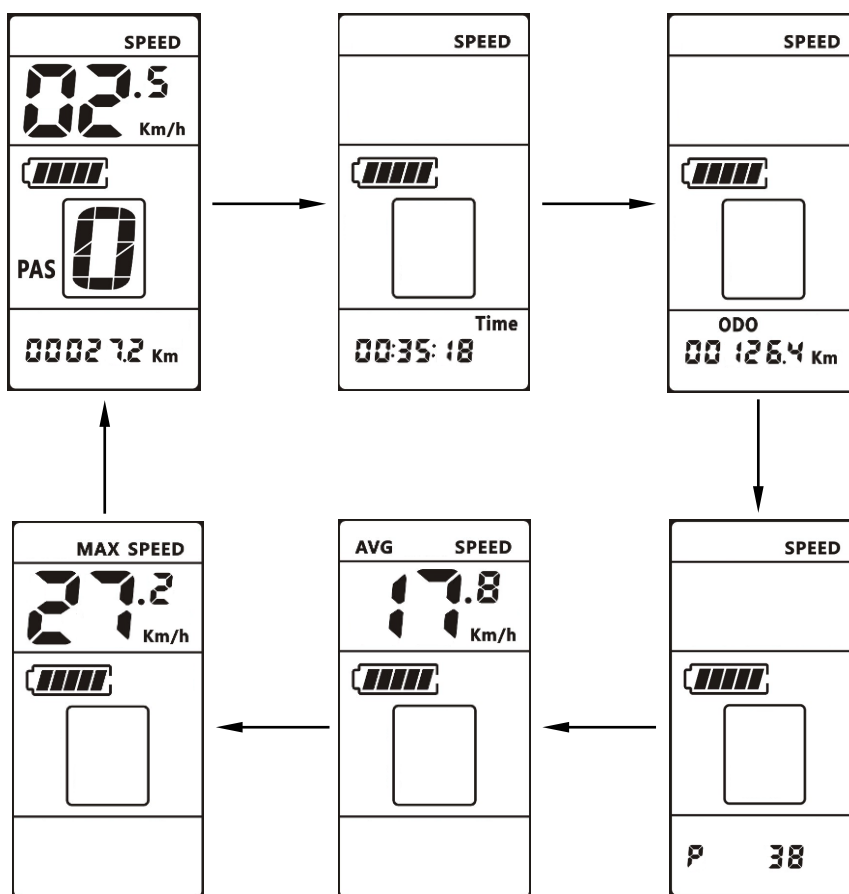

Speed mode and Mileage mode

*If the display is not operated for 5 seconds, the display will return Speed (Real-Time) display automatically.

Headlight/backlight On/Off

Press and hold the UP button for 1 second to turn on/off the headlight/backlight.

The motor does not work when the battery voltage is too low, but the display can keep the headlight on for a while when you're riding the E-bike.

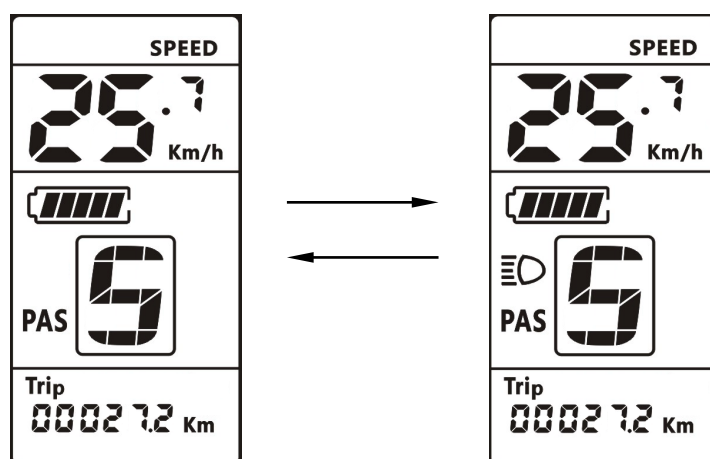

6km walk

Press and hold the DOWN button for 1 second to get into walking mode, to quit the walking mode just release the button.

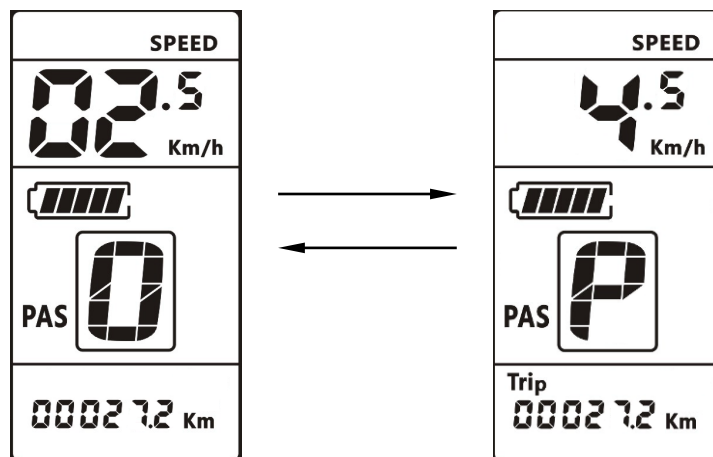

Battery indicator

When the battery indicator shows that the battery is low, the battery needs to be charged.

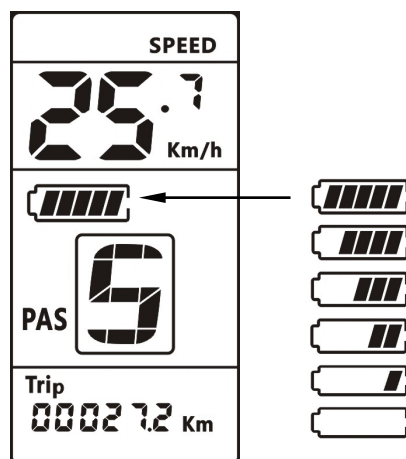

Basic Parameter settings

Press and hold the UP & DOWN buttons together for 1 second to get into the Basic Parameter settings, and the parameter will flash. The display will automatically quit the parameter settings when it's not operated for 10 seconds.

The order of Basic Parameters are as follows;

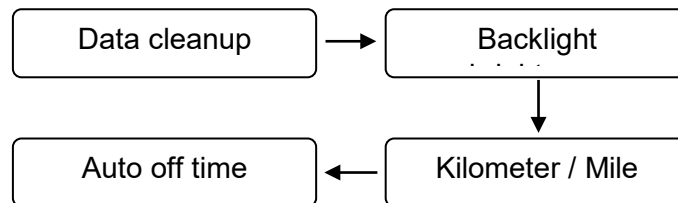

Data cleanup

The symbol tC shows on the top; press the UP or DOWN button to change between the symbols N/Y. N: does not need to be cleared, Y: needs to be cleared.

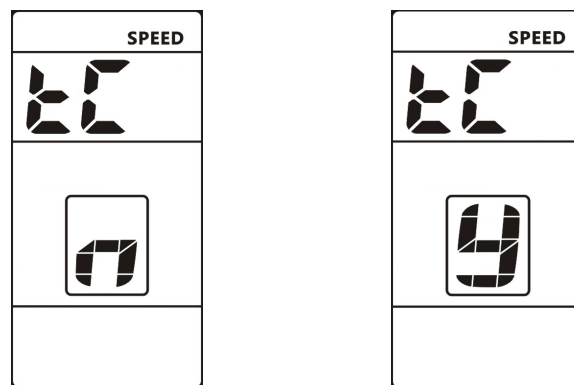

*the temporary data includes AVG Speed / MAX Speed / Trip / Time.

Backlight brightness

The symbol bl1 shows on the top, press the UP or DOWN button to change the brightness of the backlight (values 1 - 5). The default value is 3.

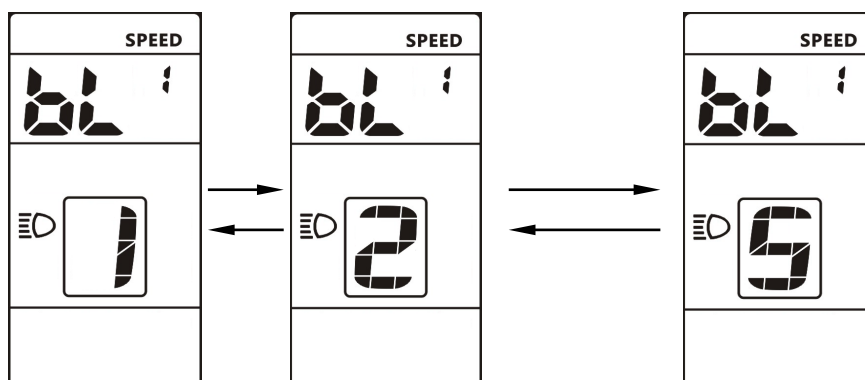

Kilometer / Mile

The symbol S7 shows on the top, press the UP or DOWN button to change between the symbols km/h / MPH (Km / Mile).

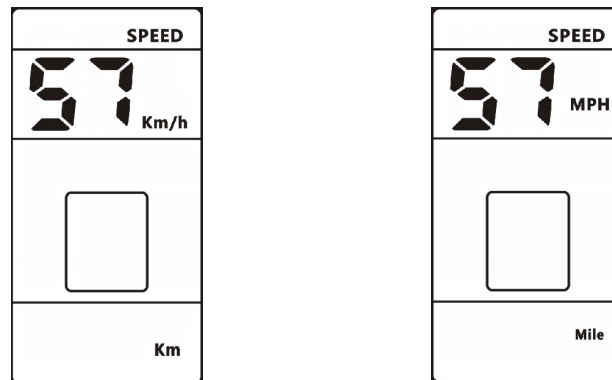

Auto off time

The symbol OFF shows on the top, press the UP or DOWN button to change the value from 1 to 9. The value represents the delay time (in minutes) before the display shuts down automatically, the default value is 5 minutes.

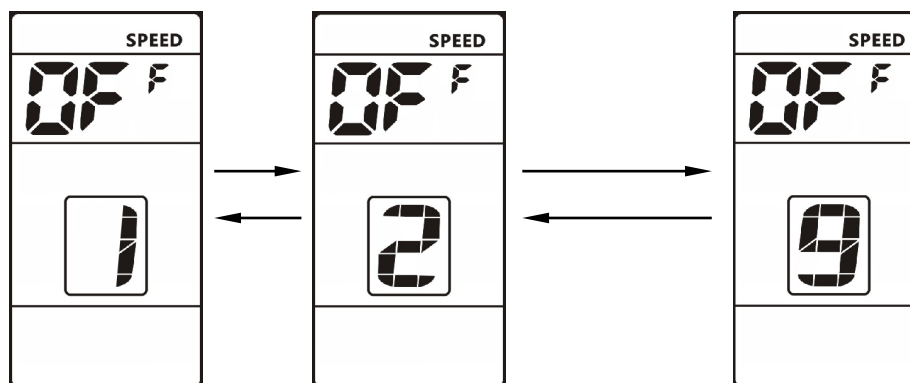

Password Parameter settings

Press and hold the UP & DOWN buttons together for 1 second to get into the Basic Parameter settings, then press and hold the UP & DOWN buttons together for 1 second again to get into the Password Parameter settings.

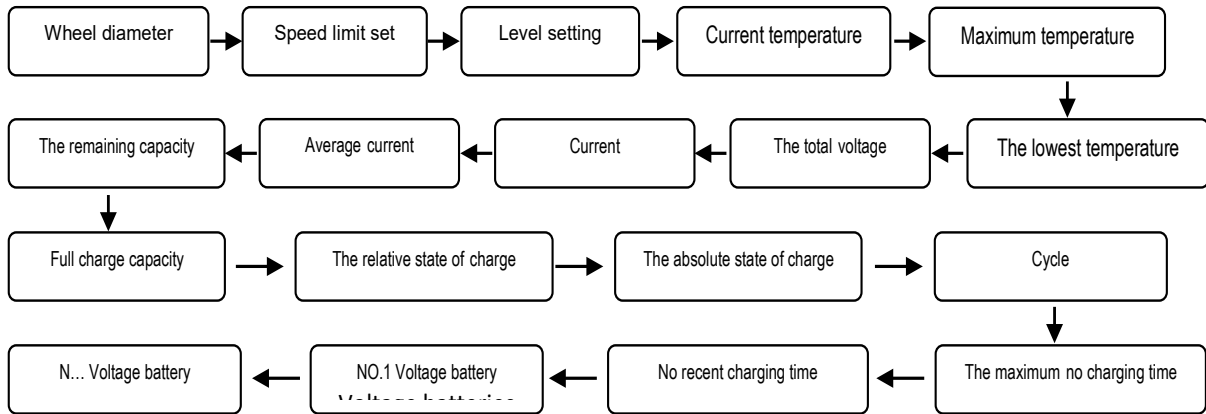

Password

The symbol PSd shows on the top, and you need to enter the password. Press the UP or DOWN buttons to change the password value (0~9) and shortly press the POWER button to the next value. The password is 4 digits, the default password is "0512". Press the POWER button when you finished entering the password. The display will return to the Speed (Real-Time) display automatically if the password is incorrect. With the correct password you will enter the Wheel diameter settings.

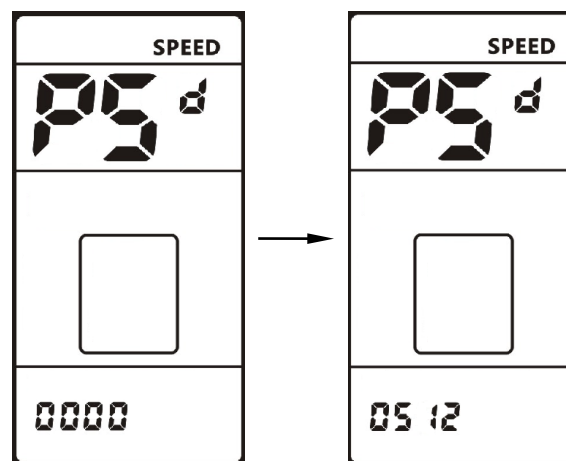

Wheel diameter

The symbol Wd shows on the top, press the UP or DOWN button to change between the values 8/10/12/14/16/18/20/22/24/26/27/28/29, the value represents the diameter of the wheel (in inches). A wrong wheel diameter setting will cause an incorrect speed reading.

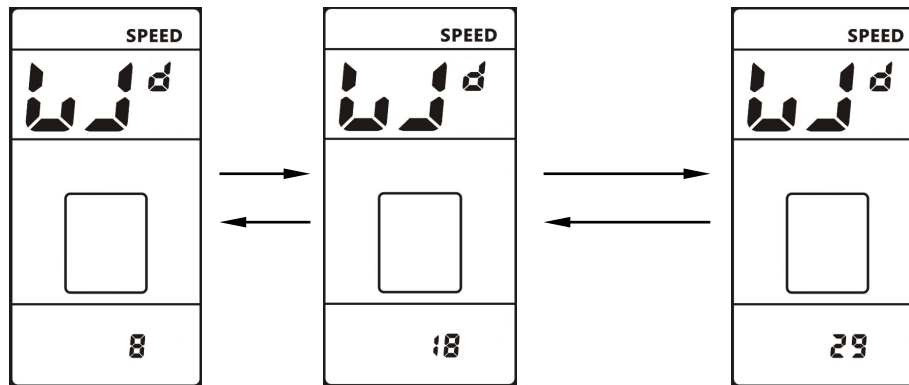

Speed limit

The speed limit shows on the top, the default value is 27km/h. Press the UP or DOWN buttons to change the limit; the limit can be set from 10 to 99km/h. Press the POWER button to confirm when you've finished setting the speed limit.

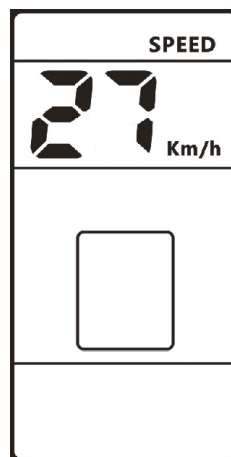

The maximum speed that can be reached is restricted by the specs of the motor and controller.

Range of assist levels

The symbol PAS shows on the top, and the assist range is shown on the bottom. The default is UBE. Press the UP or DOWN button to change the value from 0-3 to UBE.

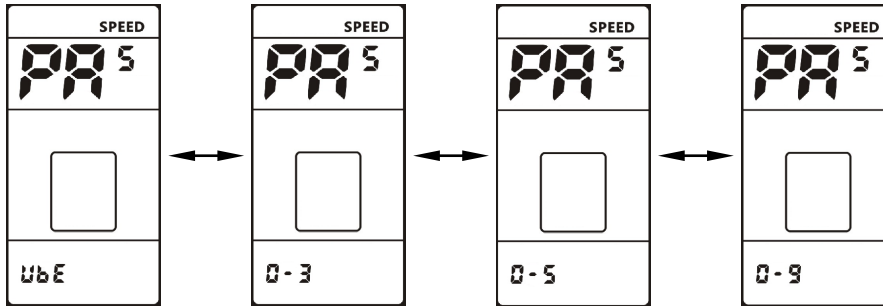

PLEASE NOTE: The parameters below (b01 and onwards) are not applicable to our conversion kits and have no meaning or function. The values of these parameters might be 0 or a random number.

The current temperature

The symbol b01 shows on the top, the current temperature shows on the bottom of the display.

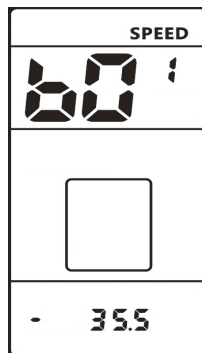

The maximum temperature

The symbol b02 shows on the top, the maximum temperature value shows on the bottom of the display.

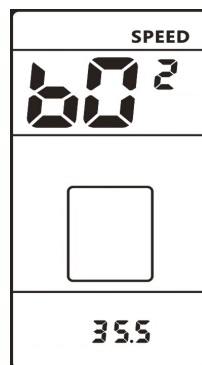

The lowest temperature

The symbol b03 shows on the top, the lowest temperature value shows on the bottom of the display.

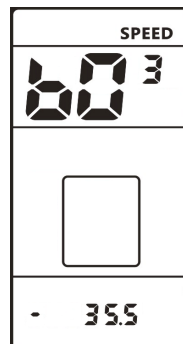

The total voltage

The symbol b04 shows on the top, the total voltage shows on the bottom.

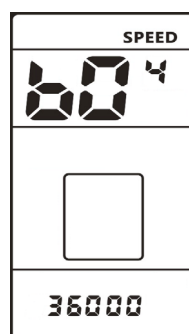

Current

The symbol b05 shows on the top, the current shows on the bottom.

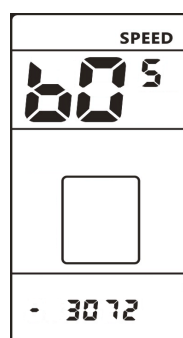

Average current

The symbol b06 shows on the top, the average current shows on the bottom.

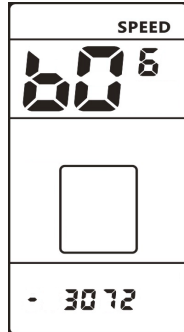

The remaining capacity

The symbol b07 shows on the top, the remaining capacity shows on the bottom.

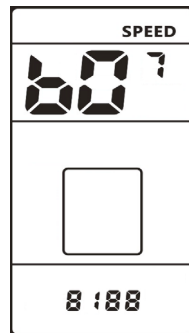

Full charge capacity

The symbol b08 shows on the top, the full charge capacity shows on the bottom.

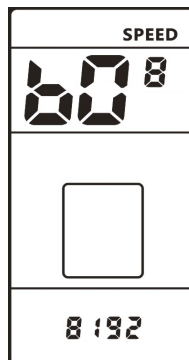

The relative state of charge

The symbol b09 shows on the top, the relative state of charge shows on the bottom.

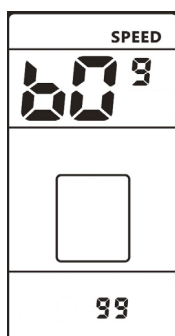

The absolute state of charge

The symbol b10 shows on the top, the absolute state of charge shows on the bottom.

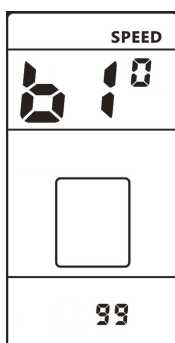

Cycle

The symbol b11 shows on the top, the cycle value shows on the bottom.

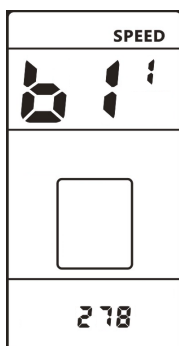

The maximum no charging time

The symbol b12 shows on the top, the maximum no charge time value shows on the bottom.

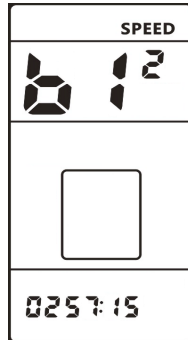

No recent charging time

The symbol b12 shows on the top, the no recent charging time value shows on the bottom.

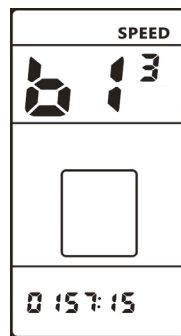

NO.1~n Voltage battery

The symbol d01 shows on the top, the NO.1~n voltage battery value shows on the bottom of the display.

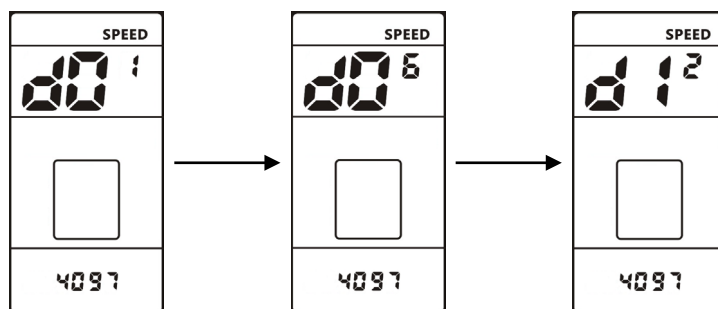

Error Code definitions

The display will give a warning message when there's an error in the system. The LCD display will show an error code on the top of the display, the error codes range from 01H~FFH. You can find the definitions in the table below.

Error Code	Error description	Error Code shown
0x01	Normal	No error
0x03	Brake signal	03 on the top of the display
0x06	Low voltage protection	06 on the top of the display
0x07	High voltage protection	07 on the top of the display
0x08	Hall line of motor error	08 on the top of the display
0x09	Phase line of the motor error	09 on the top of the display
0x10	High temperature of controller	10 on the top of the display
0x11	Controller's temperature sensor error	11 on the top of the display
0x12	Current sensor error	12 on the top of the display
0x13	Battery temperature sensor error	13 on the top of the display
0x14	Motor temperature sensor error	14 on the top of the display
0x21	Motor speed sensor error	21 on the top of the display
0x22	BMS communication error	22 on the top of the display
0x23	Head light error	23 on the top of the display
0x30	Communication error	30 on the top of the display

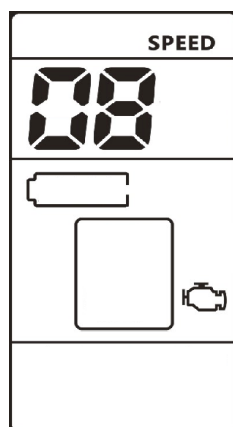

Assembly instructions

Don't use too much torque when tightening the screw, damage caused by excessive torque does not fall under the warranty.

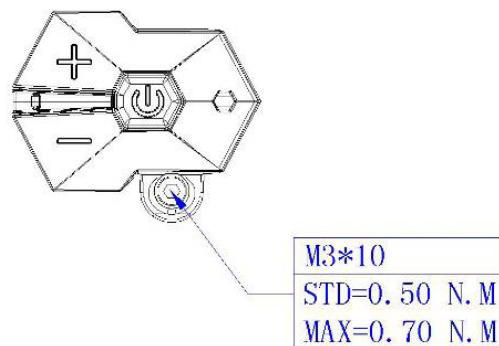
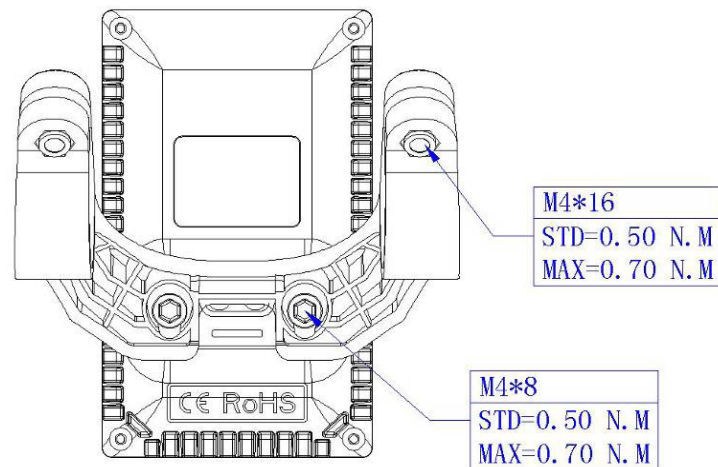

You can install the display clamps forwards or backwards as shown below.



The clamps are suitable for 3 handlebar sizes; 31.8mm, 25.4mm and 22.2mm. There are spacer rings for 25.4mm and 22.2mm handlebars. The spacer rings must be inserted into the clamps, as shown by the green arrow below.

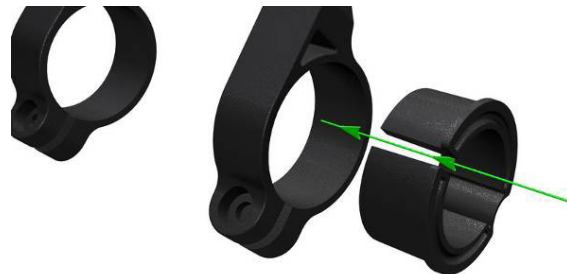

Output wires

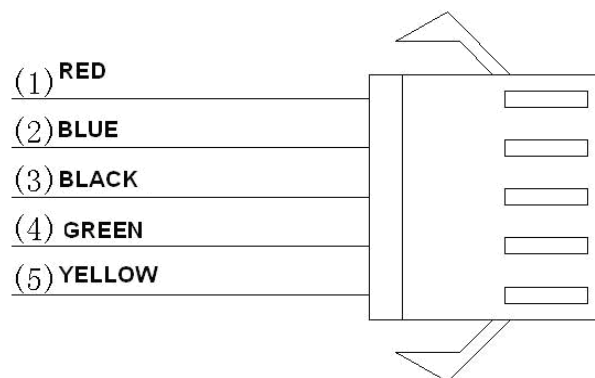

- 1. Red wire: Anode(24v/36v)
- 2. Blue wire: Power cord to the controller
- 3. Black wire: GND
- 4. Green wire: RxD (controller -> display)
- 5. Yellow wire: TxD (display -> controller)

Assist level instructions

The Assist level can be customized, the highest number of levels is 9. See the different level options below:

3 level	5 level	9 level	
0		0	No power assist
	1	1	
		2	
1	2	3	
		4	
	3	5	
2		6	
	4	7	
		8	
3	5	9	