

Sound Recorder/Datalogger

850018

Instruction Manual

SPER
SCIENTIFIC

Environmental Measurement Instruments

TABLE OF CONTENTS

INTRODUCTION	3
FEATURES.....	4
MATERIALS SUPPLIED	4
FRONT PANEL DESCRIPTION.....	5
LCD DISPLAY	6
SET UP	7
CALIBRATION	9
METHOD DESCRIPTIONS.....	10
MEASUREMENT PROCEDURES.....	12
SOFTWARE DOWNLOAD AND GENERAL USE.....	14
SOFTWARE KEY METRICS.....	17
CARE AND MAINTENANCE.....	18
SPECIFICATIONS	19
WARRANTY	20

INTRODUCTION

This Sper Scientific Sounder Recorder (model 850018) is an IEC 61672:2013 Class 2 and ANSI S1.4:2014 Type 2 meter. Meets ANSI S1.43:1997 and IEC 61672-3:2013 for Integrating-Averaging Sound Level Meters. With a sound recording playback feature. While measuring all of the industry standard sound level requirements, the audio playback also allows management to quickly pinpoint the cause of certain sound level spikes during a time period. Instances of traffic noise, machinery, music, or voices are easily heard in the audio playback file. The meter's downloadable free software conveniently provides all test parameters in one display. Data can be stored, shared, and exported. Calibration can be performed in seconds using the optional Acoustical Calibrator (850016), eliminating the need to send the unit out for quick adjustments. With the added benefit of an optional N.I.S.T traceable certificate of calibration, an available microphone extension cable for remote measurements, and a tripod mountable slim housing, this sound meter is the most versatile on the market.

FEATURES

- 64,000 record memory
- IEC 61672:2013 Class 2 and ANSI S1.4:2014 Type 2 compliant
- Meets ANSI S1.43:1997 and IEC 61672-3:2013 for Integrating-Averaging Sound Level Meters.
- Free downloadable software that simultaneously shows all test parameters
- Calibrates with the 850016 Acoustical Calibrator (not included)
- Real-time bar graph
- A and C frequency weighting
- Fast and Slow time weighting
- Leq data via software
- Maximum and Minimum values
- Lightweight slim design
- Over/Under visual alarm
- Tripod compatible

MATERIALS SUPPLIED

- Datalogging Sound Recorder
- Carrying case with custom foam interior
- Windscreen
- AC/DC adapter for analog output
- Bi-directional USB cord
- 4 AAA batteries
- Micro SD card
- Instruction manual

FRONT PANEL DESCRIPTION

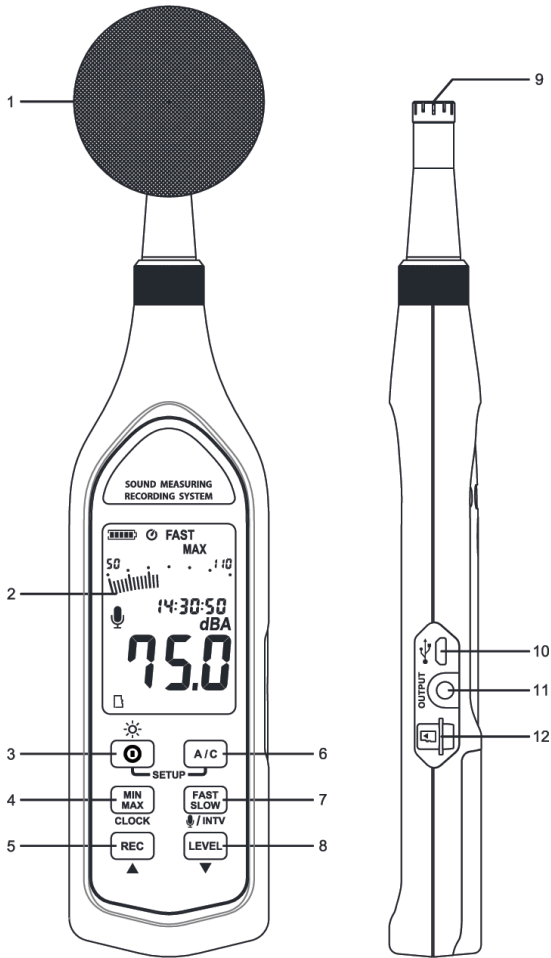

- | | |
|----------------------------|---|
| 1. Windscreen | 7. FAST/SLOW Selection |
| 2. LCD screen | 8. LEVEL Range Selection |
| 3. POWER Button | 9. Microphone |
| 4. MIN/MAX Button | 10. USB Output |
| 5. REC Button | 11. AC/DC Output jack for 3.5 mm coaxial option |
| 6. A/C Frequency Selection | 12. Micro SD Card Slit |

LCD DISPLAY

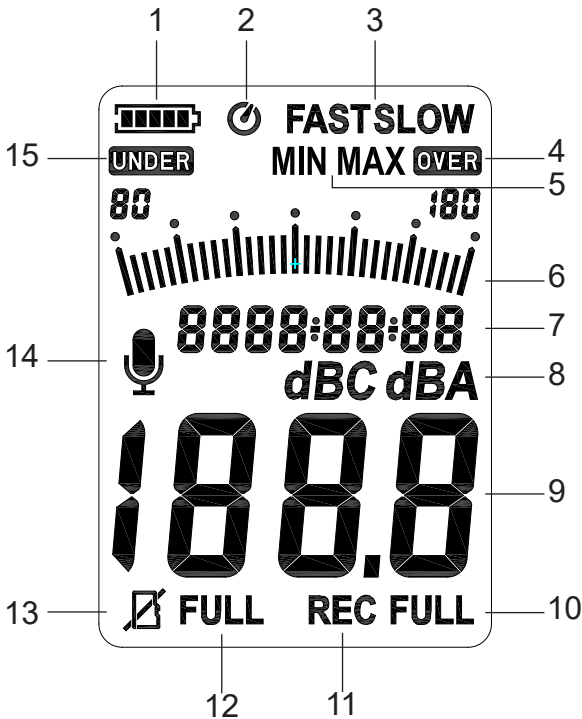

1. Battery Life Indicator
2. Auto Power-Off Activated
3. FAST or SLOW Time Weighting Indicator
4. Over-Range Indicator
5. MIN/MAX Mode Activated
6. Bar Graph Display
7. Date/Time
8. A or C Frequency Weighting Indicator
9. Sound Level Value
10. Internal Memory Full Indicator
11. Record Mode Indicator
12. Micro SD Card Full Indicator
13. Audio Overlay Deactivated
14. Audio Overlay Activated
15. Under-Range Indicator

SETUP

Battery Installation

This meter uses 4 AAA batteries. To install the batteries before first use:

1. Slide the battery cover on the back of the meter down, exposing the battery chamber.
2. Remove the battery cover.
3. Insert four new AAA batteries, ensuring correct polarity.
4. Slide the battery cover back up until it clicks.

Replace the batteries when the low-battery icon appears on the LCD.

Note...

Before replacing the batteries, turn the meter **off**.

Meter On and Off

1. Press **POWER** to turn the meter **on**.
2. Press and hold **POWER** to turn the meter **off**. A 3-second count down will show on the LCD, indicating that the meter is about to turn **off**.
3. The meter will automatically turn off after thirty minutes of inactivity.

Disabling the Auto Power off Feature

The auto power-off is disabled when connected to a PC or when the unit is in recording mode. However, the auto power-off can be manually disabled by following these steps.

1. Turn the meter **off**.
2. Press and hold the **FAST/SLOW** button while turning the meter **on**.

Backlight On and Off

1. Press **POWER** to turn the meter **on**.
2. Briefly press **POWER** to turn on the backlight **on/off**.
3. The backlight will automatically turn off after thirty seconds of inactivity to save battery life.

Setting the Date and Time

1. Turn the meter **off**.
2. Simultaneously press **POWER** and **A/C** until SET appears on the screen.
3. Press **MIN/MAX** and the screen will show the date in the format year-month-day.
4. Using the **UP** and **DOWN** arrows, adjust the flashing number to the desired value and press **MIN/MAX** to advance to the next position.
5. After the date has been set, the meter will automatically advance to the time in military format as hour-minute-second.
6. Using the **UP** and **DOWN** arrows, adjust the flashing number to the desired value and press **MIN/MAX** to advance to the next position.
7. Once the time has been set, the meter will pause up to three seconds and return to normal measuring mode.

CALIBRATION

This meter comes factory calibrated and is ready for use out of the box. However, for highly regulated industries in which a frequent calibration is required, this meter can be calibrated using the Sper Scientific Acoustic Calibrator (850016) by following these simple steps.

1. Ensure you are in a quiet environment without background noise.
2. Remove the windscreen from the sound meter, exposing the microphone.
3. Turn the sound meter's power **off**.
4. Slide the microphone into the opening of the calibration cylinder as pictured to the right until the meter fully seats in the cylinder. This may require firm and steady pressure.
5. Turn the calibrator **on** by sliding the toggle switch to 94 dB.
6. Simultaneously Press **MIN/MAX** and **POWER** on the sound meter. Cal 94 dB will display on the LCD.
7. Allow the sound reading to stabilize.
8. Use the **UP** and **DOWN** arrows to adjust the reading to 94.0 dB. When adjusting the dB value, the screen will temporarily show a decimal value of 0.1 or 0.0. This is normal and the meter will return to the calibration reading within a few seconds.
9. Press **MIN/MAX** to accept the 94.0 value and return to normal mode.

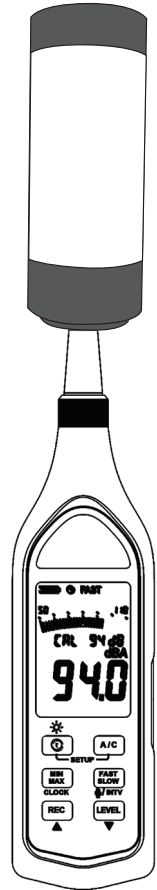

Note...

If you wish to abort calibration at any time or entered calibration mode by mistake, simply turn the meter off and no calibration will be stored.

METHOD DESCRIPTIONS

This meter has several functions to meet every acoustical requirement of your business. The following describes the different features and how they might be applied.

Leq

The cumulative sound level exposure (Leq) is the integration of the Sound Pressure Level (SPL) over an established length of time, such as an 8-hour workday. This method is particularly useful to describe sound levels that vary over time. Leq is reported as a single decibel value and is easily viewed using the meter's included software.

Windscreen

The meter can detect sound without the optional windscreen and is usually operated without it. The windscreen is only necessary in windy environments because it blocks the undesirable signal from the wind.

A and C Weighting

The meter can measure sound using both A and C weighting modes. While A weighting most closely resembles the sound experience of the human ear, your application may require C weighting depending on the sound level. In particularly noisy environments with machinery or crowds, C weighting may be more appropriate. Be sure to check with the appropriate regulatory agencies to ensure your test methods are appropriate.

Fast and Slow Time Weighting

The meter can measure sound using both Fast and Slow time weightings. Time Weighting refers to the speed at which readings are taken and is not to be confused with the screen refresh rate, which remains constant. Slow weighting takes a reading approximately every second while Fast weighting takes several readings per second. If sounds are highly erratic with frequent spikes, using the Slow weighting will smooth your data, allowing trends to be more visible. The Fast weighting will provide more data points within a timeframe.

MEASUREMENT PROCEDURES

Normal Mode

1. Press **LEVEL** to select the desired range. The chosen range will appear just above the bar graph at the top of the LCD.
2. Press **FAST/SLOW** to select your desired time weighting.
3. Press **A/C** to select your desired frequency weighting.
4. The intensity of sound will be displayed as a numerical value in decibels (dB).

Record Mode

1. Turn the meter **off**.
2. Press **A/C** and **POWER** simultaneously. SET will appear on the LCD.
3. Press **FAST/SLOW** until Int appears.
4. Using the **UP** and **DOWN** arrows, choose your desired recording interval. You can set the meter to automatically take a reading every 1 to 60 seconds.
5. Press **FAST/SLOW** to confirm. The meter will return to measuring mode after briefly displaying the date and time.
6. Press **REC**. The LCD will say SET.
7. Press **FAST/SLOW** to toggle the audio recording function **On** or **Off**.
8. Press **REC** to begin recording.
9. To end recording early or to stop record mode, press and hold **REC** again.

Note...

The micro SD card **MUST** be installed in the meter for the audio file to be recorded. If it is not installed, only noise level data will be recorded, but not the actual sound.

Min/Max Mode

1. Press the **Min/Max** button three times to enter Min/Max mode.
2. MIN MAX will blink at the top of the LCD indicating that Min/Max mode is underway.
3. The meter will continue recording in Min/Max mode until you press **Min/Max** again.
4. The meter will immediately display the Maximum value.
5. Press **Min/Max** again to obtain the Minimum value.
6. You can continue to add values and update the Min/Max data set as long as you do not exit Min/Max mode.
7. To exit Min/Max Mode press and hold **Min/Max** until MIN MAX disappears from the top of the LCD.

Internal Memory

To clear the internal memory, follow these steps.

1. Turn the meter **off**.
2. Simultaneously press **REC** and **POWER** for five seconds. The meter will show CLA and begin a 5 second countdown on the LCD. Do not let go of the buttons during this countdown.
3. When complete, the meter displays clear and returns to normal measuring mode.

SOFTWARE DOWNLOAD AND GENERAL USE

You can now download the software that came with your meter directly on your computer. Go to **www.sperdirect.com** and find your meter or you can also type in the meter number (**850018**) in search box and download from the product page.

Software General Use

1. Remove the Micro SD card from the meter and insert it into the computer via a card reader or a direct slot.

Note...

The software cannot pull the audio wave files directly from the meter. The micro USB must be separately connected to the computer.

2. Attach the sound meter to the computer with the USB cable.
3. Upon opening the software, the following screen will appear. The software will automatically show the meter in real-time.

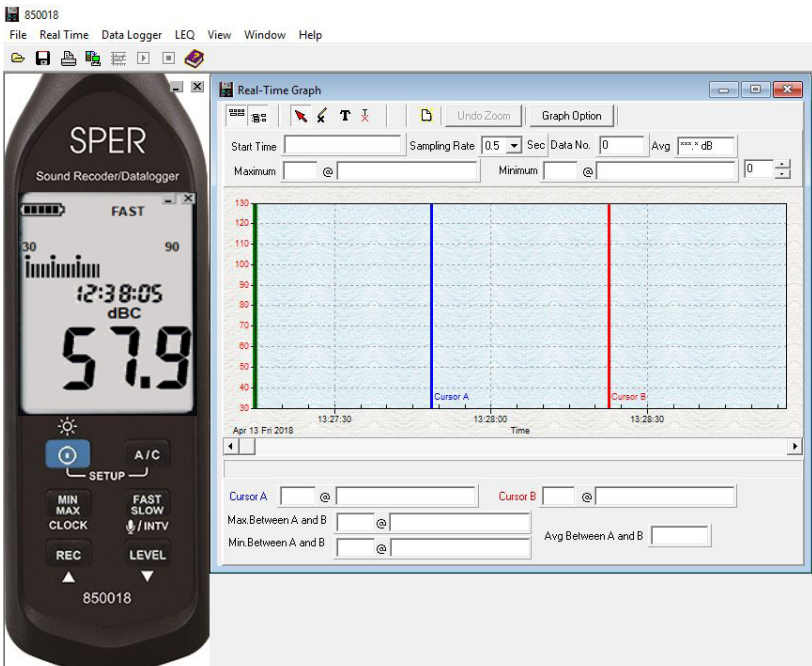

TO RECORD IN REAL-TIME

1. Using the tabs at the top of the screen, click Real Time and then Run.
2. Click **Real Time** and then **Stop** to finish the recording.

TO DOWNLOAD DATA AND AUDIO FILES.

1. Using the tabs at the top of the screen, click **Data Logger** and then **Load Data**. The following screen will open. Note the corresponding sound recording in the right-most column if an audio overlay was chosen.

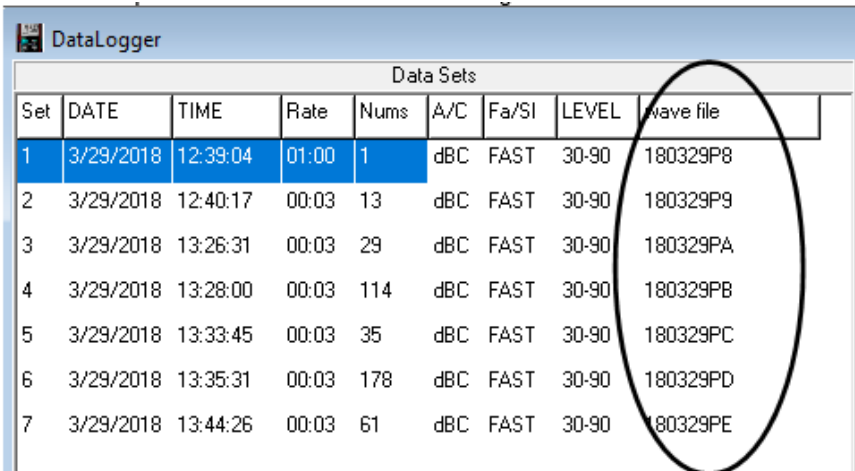

The screenshot shows the DataLogger application window with a table titled "Data Sets". The table has columns for Set, DATE, TIME, Rate, Nums, A/C, Fa/Sl, LEVEL, and wave file. The first row is highlighted in blue. A black circle is drawn around the "wave file" column.

Set	DATE	TIME	Rate	Nums	A/C	Fa/Sl	LEVEL	wave file
1	3/29/2018	12:39:04	01:00	1	dBC	FAST	30-90	180329P8
2	3/29/2018	12:40:17	00:03	13	dBC	FAST	30-90	180329P9
3	3/29/2018	13:26:31	00:03	29	dBC	FAST	30-90	180329PA
4	3/29/2018	13:28:00	00:03	114	dBC	FAST	30-90	180329PB
5	3/29/2018	13:33:45	00:03	35	dBC	FAST	30-90	180329PC
6	3/29/2018	13:35:31	00:03	178	dBC	FAST	30-90	180329PD
7	3/29/2018	13:44:26	00:03	61	dBC	FAST	30-90	180329PE

2. Select your desired data file by double-clicking the line item of the file. The selected file will be highlighted in blue.
3. To hear the audio wave file, click the  icon located in the upper right part of the screen.
4. A dialogue box will open. Select the **Micro SD drive**.
5. Select the main folder. Remember that the micro SD card cannot be installed in the meter during this step. The micro SD card must be directly connected to the computer through a card reader or slot within the computer.
6. The software will automatically locate the wave file associated with your noise level file. Select and open the wave file.

7. Click the **Play** button  in the upper right-hand corner of the screen. The audio file will play along with a moving green cursor. The green cursor provides a live

time-stamp of the audio file that is superimposed on the noise level chart.

SOFTWARE KEY METRICS

dB READING AT A SINGLE POINT:

1. Place Cursor A or Cursor B on the desired point by dragging the line.
2. The bottom of the screen will display the dB level along with the date/time stamp at the selected point. *See image below.*

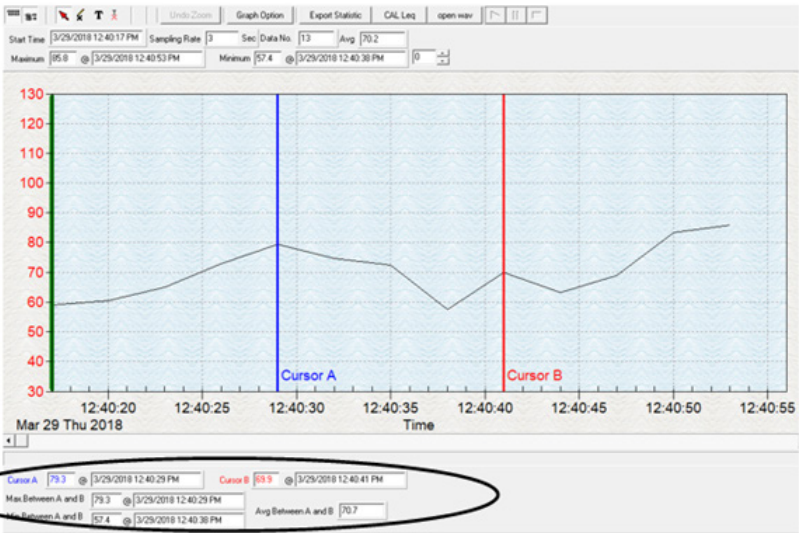

MIN/MAX and AVERAGE BETWEEN TWO POINTS

1. Use Cursors A and B to choose your time interval.
2. The bottom of the screen will display the Minimum, Maximum, and Average values between the two selected points. *See image above.*
3. To quickly copy the critical information between these two points, click the **Export Statistic** icon located in the upper middle portion of the screen. This will place all the critical data to your clipboard in a text only format. It can now

paste anywhere.

Leq CALCULATION

1. Within a noise level file, click the **CAL Leq** icon in the upper right-hand corner of the screen. A graph will appear in a new window. The cumulative Leq value for the recorded time period will appear as circled in the image below.



2. The Leq line average is noted in red on the Leq graph.
3. The Sound Pressure Level SPL appears in black.

CARE AND MAINTENANCE

- Do not drop the meter, which may damage the microphone and LCD.
- Keep the microphone dry.
- Avoid exposing the unit to excessive vibration.
- Do not store the instrument in high-temperature or high-humidity environments.
- Occasionally wipe the meter with a clean dry cloth. Do not use abrasives or carbon-based solvents on the meter.
- Remove the batteries and store the meter in a low-humidity environment if not in use for an extended period of time.

- Repairs or services not covered in this manual should be performed by qualified personnel only. Please contact Sper Scientific to speak with a technician.

SPECIFICATIONS

Accuracy	± 1.0 dB (Under reference conditions @ 94 dB, 1 KHz)
Regulatory Standards	IEC61672-1 and ANSI S1.4 Type 2
Measurement Range	30 to 130 dB
Frequency Range	20 Hz to 8 KHz
Dynamic Range	60 dB
Frequency Weighting	A/C
Time Weighting	FAST (125 milliseconds) SLOW (1 second)
Microphone	½ inch electret microphone
Digital Display	4 digits
	Resolution: 0.1 dB
	Update rate: 50 milliseconds
Analog Display	30-segment bar graph
	Resolution: 2 dB
	Update rate: 50 mS
Datalogging Capacity	64,000 records
AC Output	1 Vrms at full scale
DC Output	10 mV/dB
Power Supply	Four 1.5V AAA alkaline batteries
Power Life	Approximately 20 hrs. w/Alkaline battery 5 hours with Audio Recording
Power Consumption	Approximately 0.2 W
External Power Supply	5 VDC (micro USB plug)
Operating Temperature	32°F to 104°F (0°C to 40°C)
Operating Humidity	10% to 90% RH
Storage Temperature	14°F to 105°F (-10°C to 40°C)
Storage Humidity	10% to 75% RH
Operating Altitude	≤ 2000 meters

WARRANTY

Sper Scientific warrants this product against defects in materials and workmanship for a period of **five (5) years** from the date of purchase, and agrees to repair or replace any defective unit without charge. If your model has since been discontinued, an equivalent Sper Scientific product will be substituted if available. This warranty does not cover batteries, battery leakage, or damage resulting from accident, tampering, misuse, or abuse of the product. Opening the meter to expose its electronics will void the warranty. To obtain warranty service, ship the unit postage prepaid to:

SPER SCIENTIFIC LTD.

8281 E. Evans Rd., Suite #103

Scottsdale, AZ 85260

(480) 948-4448

The defective unit must be accompanied by a description of the problem and your return address. Register your product online at www.sperwarranty.com within 10 days of purchase.