

**Datalogging
RTD
Thermometer
Certified**

800118C

Instruction Manual

SPER
SCIENTIFIC

Environmental Measurement Instruments

TABLE OF CONTENTS

INTRODUCTION.....	3
PANEL DESCRIPTION.....	4
MEASUREMENT PROCEDURES.....	5
SETUP MODE.....	7
DATALOGGING.....	10
POWER MANAGEMENT.....	19
AUTO POWER OFF.....	19
BATTERY REPLACEMENT.....	19
SPECIFICATIONS.....	20
OPTIONAL ACCESSORIES.....	21
WARRANTY.....	24

INTRODUCTION

The platinum resistance temperature probe offers the highest accuracy and stability even at very low temperatures and under changing environmental conditions. Results are displayed in °C or °F on a large backlit LCD along with Max/Min readings. Automatically record up to 16,000 data points with time stamp that can be downloaded and analyzed with the included USB computer cable and software. Also features relative temperature, data hold, auto-power-off, low battery indicator, and a tripod back. Comes ready to use in a protective, foam lined carrying case with a Pt-100 probe, 9V battery, USB computer cable and full instructions.

PANEL DESCRIPTION

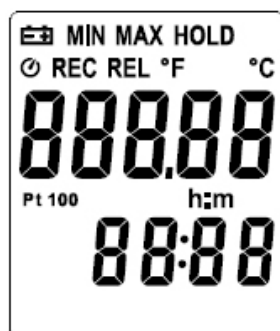

: The Battery is not sufficient for proper operation.

MIN : The Minimum value is now being displayed

MAX : The Maximum value is now being displayed

HOLD : This indicates that the display data is being hold.



: This indicates Auto Power Off is enabled.

REC : Readings are being logged.

REL : The reading is now under Relative Mode.

°C °F : Centigrade and Fahrenheit indication.

- : This indicates that the minus temperature is sensed.

h:m : hours; minute

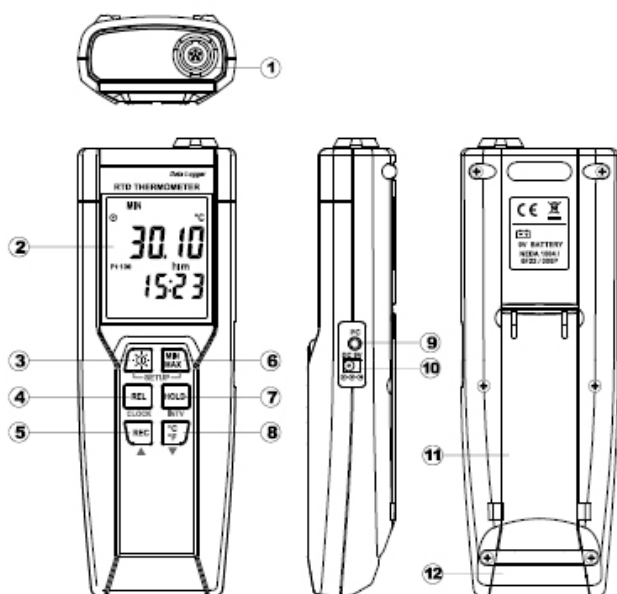

① Pt type temperature sensor connector

② LCD display

③ Power ON/OFF and Back light button

④ Relative readout button

⑤ REC button

⑥ MAX MIN control button

⑦ HOLD button

⑧ °C , °F control button

⑨ PC Interface

⑩ External DC 9V power supply jack

⑪ Tilt stand

⑫ Battery Compartment

MEASUREMENT PROCEDURES

Temperature Measurement

1. Plug the probe into the top of the meter.
2. Press the power button  Temperature readings will appear on the large upper display with the time shown on the lower display.
3. The temperature sensor is located at the end of the metal temperature probe. To ensure accurately readings insert the probe at least 2" into the substance being measured.

°C/°F

Press the °C/°F button to select the temperature scale. "°C" or "°F" will appear on the LCD.

Backlight

Press the power / backlight button  to turn the back light on / off.

Hold Mode

1. Press the **HOLD** button during measurement to freeze the Temperature display. "HOLD" and the temperature are shown.
2. Press **HOLD** button again to exit this mode.

Note...

While in Hold function **REL**, **MAX/MIN** and **°C/°F** keys are disabled.

MEASUREMENT PROCEDURES

Maximum/Minimum Mode

1. Press **MIN MAX** to enter the min/max mode. "MAX" appears on the LCD and the meter will now begin storing the maximum and minimum values. The maximum temperature reading appears on the display updated each time a new maximum (peak) temperature is reached..
2. Press **MIN MAX** again. "MIN" appears on the LCD and a continually updated minimum temperature appears on the display.
3. Press **MIN MAX** again. "MIM MAX" will flash on the LCD and the meter will continue recording data while showing current temperature.
4. Press **MIN MAX** for 2 seconds at any time to exit min/max mode and erase all Min/Max data.

Note...

While in min/max mode the **REL**, and **°C/°F** keys are disabled.

The thermometer must be in the min/max mode to display minimum or maximum values. These values are not updated during temperature readings taken in the standard measurement mode.

Relative Measurement

















1. Press the **Δ REL** button during measurement to store the current temperature into memory. "REL" and "0.00°" appear on the LCD.
2. As subsequent temperatures are measured, the difference (Δ) between the stored temperature and current temperature appear on the LCD.
3. Press the **REL** button again to exit.

Example: A temperature reading of 75.00°F was stored in memory by pressing the **REL** button. Next, the probe was placed in a 55.00°F environment. "REL" and "-20.00°F" now appear on the LCD.

SETUP MODE

Setting the Time

Turn power off prior to advanced settings. Advanced settings mode will be cancelled if **POWER** is pressed.

1. Press and hold  button and then power on the meter to enter setup mode.
2. Press  button to enter Time setting mode. The right two digits blink.
3. Press  or  button until the display shows the correct **year**, and then press  button to select. The left two digits blink.
4. Press  or  button until the display shows the correct **month**, and then press  button to select. The right two digits blink.
5. Press  or  button until the display shows the correct **day**, and then press  button to select. The left two digits blink.
6. Press  or  button until the display shows the correct **hour** (24-hour format), and then press  button to select. The right two digits blink.
7. Press  or  button until the display shows the correct **minutes**, and then press  button to store the time in memory.

Note...

Holding down the “**REC**” or “**°C/°F**” causes the number to change more quickly.

SETUP MODE

Clearing Memory

When the memory is full, REC appears and blinks on the display and logging stops. You can clear memory in next power on the meter to enter clear memory mode. Press and hold  button and then power on the meter to enter clear memory mode to delete logged readings from memory. The display shows the number from 5 decreases to 0.

SETUP MODE

Recall Default factory settings

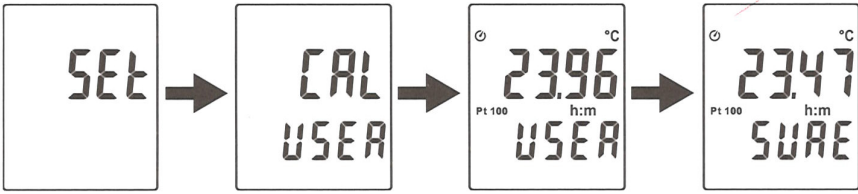

Press and hold **REL** + **HOLD** buttons and then power on the meter to enter setup mode.

Press **°C/°F** button to enter calibration mode. (in 3 seconds)

Press **MIN/MAX** button to enter recall mode. (in 3 seconds)

Press **HOLD** button to confirm revert back to “Default factory setting value”.









Press **HOLD** button to confirm selection.

Note: To abort during the process, press **⊗** button to exit calibration mode.

DATALOGGING

Changing the Logging Interval

The logging interval determines how often the thermometer stores logged readings in memory.

1. Press and hold  button and then power on the meter to enter setup mode.
2. Press  button to enter Interval setting mode. The right two digits blink.
3. Press  or  button until the display shows the correct **hour** (24-hour format), and then press  button to select. The right two digits blink.
4. Press  or  button until the display shows the correct **minutes**, and then press  button to store the time in memory.

Note...

Holding down the “REC” or “°C/°F” causes the number to change more quickly.

Communication with a PC

Users can transfer data from the built-in memory on the instrument to a PC through SE376 software. The communication requires a USB or RS-232 serial connection.

Testlink SE376 Software

The SE376 package contains:

- 80mm CD
- Custom designed USB cable for SE376

System Required:

- Windows NT 4.0/NT2000/XP/Vista/Windows 7

DATALOGGING

Minimum Hardware Required:

- PC or NoteBook with Pentium 800MHz or higher, 128 MB RAM
- At least 50 MB hard disk space available to install SE376
- Recommended screen resolution 1024x768 or above

Install SE376 and USB-120 connector driver:

1. We recommend closing all other applications before installing SE376.
2. Insert setup CD disk to CD disk drive to display install screen. You may also run MainSetup.exe in the directory of the CD.
3. Click install to begin installation.
4. It will install USB-120 connector driver first:
5. While installing, it will show the window below, just click “**next**” to continue. (see Fig. 1)
6. Select “**Launch the CP210x VCP Driver Installer**” option, and then click Finish. (see Fig. 2)

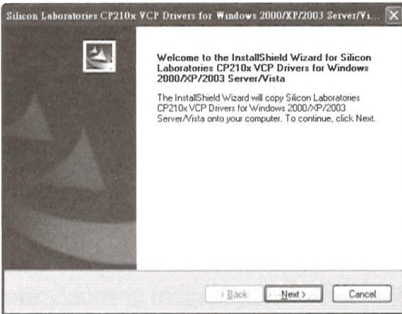

(Fig.1)

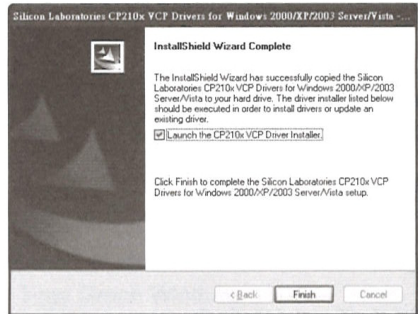

(Fig.2)

7. Click Install.

DATALOGGING

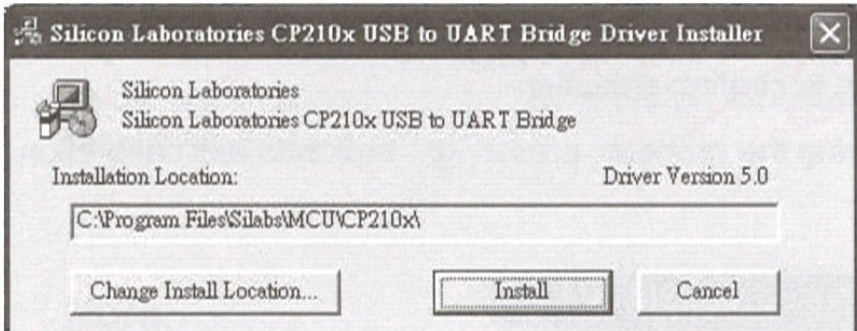

8. After you've finished installing the USB-120 connector driver, it will install SE376 software automatically. It will copy SE376.exe (executable file) and help the file to your hard disk (default is C:\program_files\SE376).

9. After you've finished installation, plug the USB-120 connector into PC USB port, execute.

10. **“start”** --> **“My Computer”**, then choose **“View System Information”** on the left top of the window, the window below will show up.

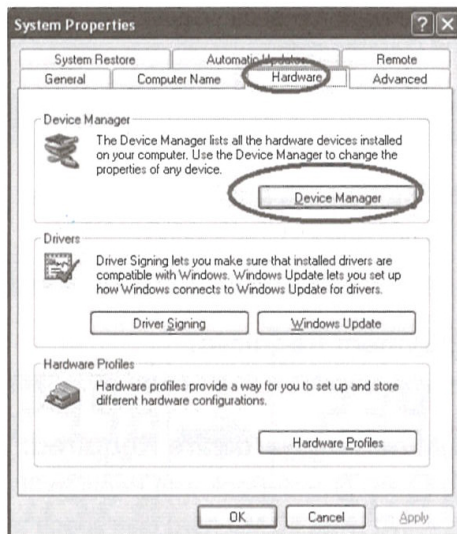





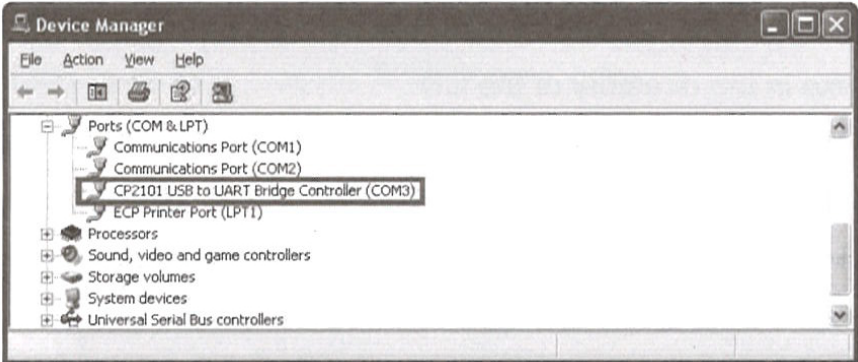

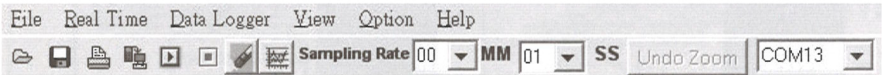

DATALOGGING

11. Choose “**Hardware**” option and click “**Device Manager**” button, click “**+**” symbol on the left side of the Ports (COM & LPT), if the device “**CP2101 USB to UART Bridge Controller (COMx)**” is in the list, the connector is ready to work.



Main menu and buttons:



-  **Open** - Retrieve files from the disk.
-  **Save** - Save the present data to the disk.
-  **Print** - Send data in the present table to the printer.
-  **Pause** - Stop data recording.
-  **Run** - Start data recording.
-  **Output to Graph** - Send table data to another graph.
-  **New** - Reset all the data.

Option - Setup dialog to set attributions of graph. (You may also double click on the graph.)

DATALOGGING

Sampling Rate - Time interval between each data to be recorded. If you want to change it, move your cursor to the digit you want to change and click, then input the new sampling rate. The change will be effective immediately. It will keep up to 5000 data points, when data points exceed this limit, the oldest 100 points will be replaced sequentially.

Real Time Graph:

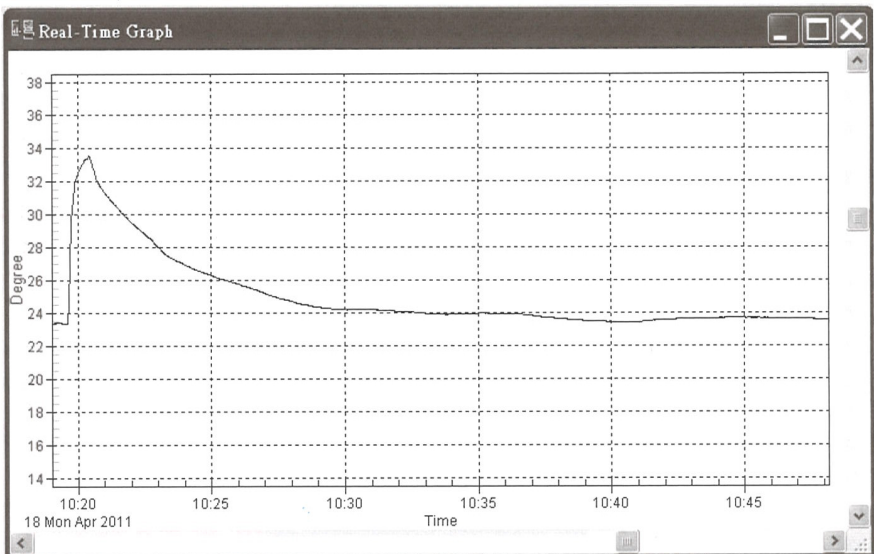

You can zoom this graph by using the mouse:

To Zoom:

1. Press and hold the Shift key.
2. Press the left mouse button and drag the cursor to select the new frame.
3. Release the mouse button.

DATALOGGING

To Undo the Zoom:

Press the Alt+U keys or click Undo Zoom button.

Note: Zooming method is not allowed in Real Time Graph Window.

Table:

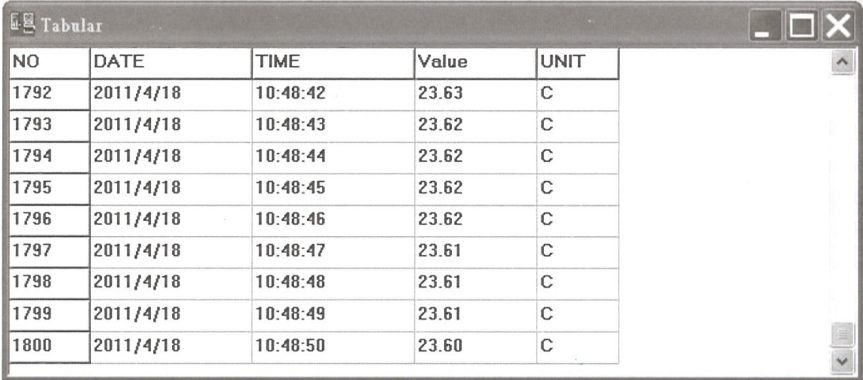

NO	DATE	TIME	Value	UNIT
1792	2011/4/18	10:48:42	23.63	C
1793	2011/4/18	10:48:43	23.62	C
1794	2011/4/18	10:48:44	23.62	C
1795	2011/4/18	10:48:45	23.62	C
1796	2011/4/18	10:48:46	23.62	C
1797	2011/4/18	10:48:47	23.61	C
1798	2011/4/18	10:48:48	23.61	C
1799	2011/4/18	10:48:49	23.61	C
1800	2011/4/18	10:48:50	23.60	C

The table window can be used to record real time data in a table format. The maximum number of records that the tabular window can keep will depend on the available memory and hard disk space on your computer.

Data Logger

When you have the thermometer connected to the computer, select “Load Data” recorded from the thermometer. There will be a progress indicator to show the loading progress.

If the error occurs, just click “Load Data” again.

After the data has been successfully loaded to the computer, the left side window shows how many data sets were loaded and their detailed information (start date, start time, recording rate and record numbers). **See next page for example.**

DATALOGGING

For example:

Data Sets				
Set	DATE	TIME	Rate	Nums
1	2010/5/7	下午 07:42:18	08:33	1
2	2010/5/7	下午 07:55:39	20:59	1
3	2010/6/25	下午 01:37:57	20:59	1
4	2010/6/25	下午 01:38:01	20:59	1
5	2010/6/25	下午 01:38:03	20:59	1
6	2010/6/25	下午 01:38:05	20:59	1
7	2010/6/25	下午 01:38:07	20:59	1
8	2010/6/25	下午 01:38:14	20:59	1
9	2010/6/25	下午 01:38:17	20:59	1
10	2010/6/25	下午 01:38:30	20:59	1
11	2010/6/25	下午 01:38:32	20:59	1

It will transfer the first data set to the graph and tabular on the right side window once you finish loading recorded data from the thermometer. You can click on any data set to show its graph and table on the right side window.

DATALOGGING

You can choose a rectangular area on the graph to zoom in for detail.

The vertical dash line in the graph will match the highlight row in the table. When clicking on another row in the table, the vertical dash line will move to the corresponding position to match the time.

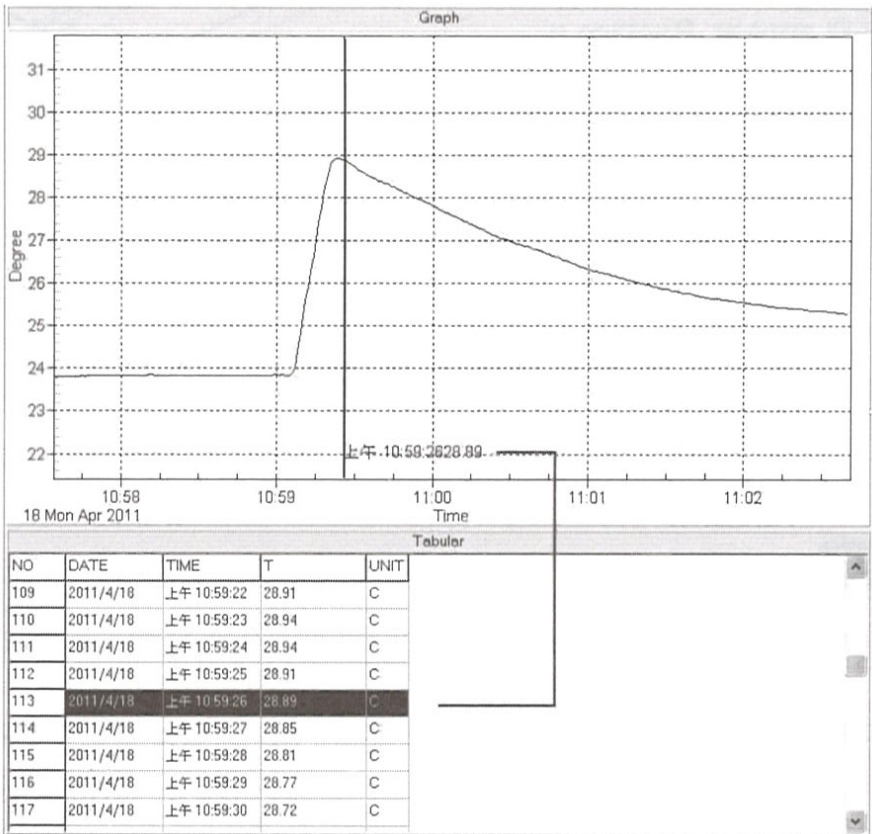

DATALOGGING

Frequently Asked Questions:

Q: I have connected the thermometer to the computer serial port and turned it on, but it still shows “NO CONNECTION”?

A: This may be because all your serial ports are occupied by other applications. Close all applications, restart your computer, and run SE376 again.

Q: In the Table window, I saved a file. Can I use EXCEL to open this file?

A: If the decimal separator is a comma (,) in your area, you cannot use the CSV file because the CSV file uses a comma to separate data. This will cause confusion (for example: 23, 6, C, 24.6, C). However, you can use TXT files instead. It uses a tab to separate to data. (for example: 23.6 C 24.6 C) and it will be accepted in EXCEL.

Q: How do you uninstall SE376?

A: Uninstall SE376 by launching the Add/Remove Programs applet out of the Control Panel, highlighting SE376, and clicking on the Add/Remove...button, it will then remove the SE376 folder and files from your computer.

POWER MANAGEMENT

Auto Power Off

The Meter automatically powers off after 30 minutes of inactivity. To override Auto Power Off press and hold the **REL** button while turning the meter on. Two beeps will sound to indicate that auto power off has been disabled.

Batteries

1. **Battery Loading** - Remove the battery cover on the back and insert one 9V battery.

2. **Battery Replacement** - When the battery voltage drops below the operating voltage, Low battery indicator  will appear. Replace a 9V battery immediately to ensure the unit functions properly.

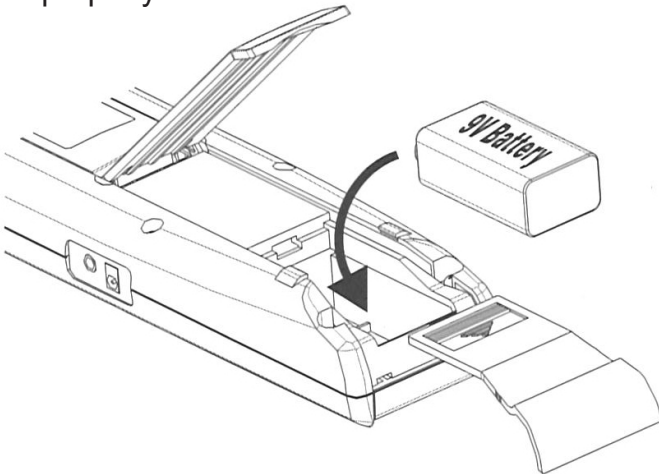

3. **AC Adapter Connection** - When the AC adapter is used, insert the plugs of the adapter into the DC9V connector on the side panel.

Note...

When the AC adapter is connected while the battery is inserted, the unit will be powered from the adapter (the AC adapter has priority).

SPECIFICATIONS

Range -148 to 752°F -100 to 400°C	Accuracy ±(0.05% reading. + 0.2°F) ±(0.05% reading. + 0.1°C)
Temperature Coefficient	For ambient temperatures of 0°C to 18°C & 28°C to 50°C: For each °C below 18°C or above 28°C add the following tolerance into the accuracy spec: 0.005% reading. + 0.01°C (0.02°F)
Resolution	0.01 C&F
Weight	13 oz (360g)
Meter Dimensions	7 ¼" x 2 ½" x 1 ½" 185 x 65 x 36 mm
Operating Environment	32 to 122°F (0°C to 50°C)
Storage Environment	14 to 140°F (10°C to 60°C) RH <70%
Sensor	Platinum Resistance temperature sensor 4 wires, selectable for Pt-100 ALPHA-0.00385 Temperature indication follows IEC751 temperature table for PT-type sensor. Probe accuracy: +/-0.15C +/-0.002t
Power	9V battery. Lasts approximately 100 hours with alkaline battery
Sample Rate	2 times per second

OPTIONAL ACCESSORIES

Waterproof Resistant Instrument Pouch - 840090
AC Adapter - 800003

NOTES

NOTES

WARRANTY

Sper Scientific warrants this product against defects in materials and workmanship for a period of **five (5) years** from the date of purchase, and agrees to repair or replace any defective unit without charge. If your model has since been discontinued, an equivalent Sper Scientific product will be substituted if available. This warranty does not cover batteries, battery leakage, or damage resulting from accident, tampering, misuse, or abuse of the product. Opening the thermometer to expose its electronics will void the warranty. To obtain warranty or recalibration service, ship the unit postage prepaid to:

SPER SCIENTIFIC LTD.

8281 E. Evans Rd., Suite #103
Scottsdale, AZ 85260
(480) 948-4448

The defective unit must be accompanied by a description of the problem and your return address. Register your product online at www.sperwarranty.com within 10 days of purchase.

Please note: The most current version of the manual can always be found at www.sperdirect.com