

Operating Instructions

Datascope Trio™



mindray™
NORTH AMERICA

Operating Instructions

Datascope
Trio™

Trio™ is a U.S. trademark of Mindray DS USA, Inc.

Navigator™ is a U.S. trademark of Mindray DS USA, Inc.

Masimo SET® is a U.S. registered trademark of Masimo Corp.

Nellcor® and OxiMax® are U.S. registered trademarks of Nellcor Puritan Bennett Inc.

SatSeconds™ is a U.S. trademark of Nellcor Puritan Bennett Inc.

Copyright © Mindray DS USA, Inc., 2008. All rights reserved. Contents of this publication may not be reproduced in any form without permission of Mindray DS USA, Inc.

Foreword.....	v
Warnings, Precautions And Notes	v
Warnings	vi
Precautions	vii
Notes	xi
Indication For Use.....	xi
Unpacking	xi
Symbols.....	xii
General Product Description.....	1 - 1
Front Panel.....	1 - 3
Front Panel Keypad	1 - 4
Display.....	1 - 6
Left Side Panel.....	1 - 10
Right Side Panel	1 - 11
Rear Panel	1 - 12
Operations	2 - 1
Getting Started	2 - 1
Setting-up Patients.....	2 - 1
Setting the Clock (Date and Time).....	2 - 2
Menus	2 - 2
System Menu.....	2 - 3
Patient Setup.....	2 - 3
List Trend	2 - 5
Graphic Trend	2 - 5
Mark Event	2 - 6
Monitor Setup.....	2 - 6
Maintenance.....	2 - 13
Normal Screen	2 - 13
Parameter Menus.....	2 - 14
Electrocardiogram (ECG) Monitoring	2 - 14
Respiration Monitoring	2 - 29
SpO ₂ Monitoring	2 - 32
NIBP Monitoring.....	2 - 44
Temperature Monitoring	2 - 53
IBP Monitoring (Optional)	2 - 56
Alarms.....	2 - 63
Alarm Categories	2 - 63
Alarm Priorities.....	2 - 64
Alarm Setup Menus	2 - 64
Alarm Troubleshooting	2 - 75
Trends	2 - 76
Graphic Trend	2 - 76
List Trend.....	2 - 79
Recorder (Optional)	2 - 82
Print Functions	2 - 82
Recorder Troubleshooting	2 - 86
Defaults.....	3 - 1
Default Configurations.....	3 - 1
Factory Default Configuration.....	3 - 1
User Default Configuration.....	3 - 6
Current Configuration	3 - 6
Non-Volatile Configuration	3 - 7

User Maintenance	4 - 1
Introduction	4 - 1
Decontamination of the Monitor	4 - 2
Care and Cleaning of the Monitor	4 - 2
Care and Cleaning of Accessories	4 - 3
SpO ₂ Sensors	4 - 3
Blood Pressure Cuffs	4 - 4
Temperature Sensor Cleaning and Disinfection (Reusable).....	4 - 6
Battery Replacement and Maintenance	4 - 6
Recorder Maintenance	4 - 7
Recorder Paper Replacement	4 - 8
Care and Storage of Thermal Paper	4 - 9
Care and Cleaning of ECG Cables and Leadwires	4 - 9
Accessories	5 - 1
Optional Accessories	5 - 1
NIBP Accessories.....	5 - 1
Oximetry Sensors and Accessories.....	5 - 3
Reusable Temperature Probes.....	5 - 4
Disposable Temperature Probes.....	5 - 4
ECG Accessories	5 - 4
IBP Accessories	5 - 5
Miscellaneous Accessories	5 - 5
Mounting Kits and Accessories	5 - 6
Replacement Parts, Trio Rolling Stand.....	5 - 6
Appendix	6 - 1
Specifications	6 - 1
Safety Standards	6 - 1
Safety Designations	6 - 2
Performance / Accuracy	6 - 3
Environmental / EMC	6 - 4
United States Food and Drug Administration Documents.....	6 - 4
Patient Parameter Specifications	6 - 5
ECG	6 - 5
ECG Performance Requirements	6 - 5
ANSI/AAMI EC13-2002 Compliance.....	6 - 7
ECG Systole Detector and Heart Rate Meter	6 - 8
ECG Respiration Performance Requirements.....	6 - 9
NIBP Sub-System Performance Characteristics	6 - 9
IBP Parameter Sub-System Performance Characteristics.....	6 - 12
IBP Safety Requirements.....	6 - 12
Temperature Parameter Performance Characteristics	6 - 13
SpO ₂ Performance Requirements	6 - 13
Physical Specifications.....	6 - 17
Information Display and Control	6 - 17
LED Indicators	6 - 17
Real Time Clock	6 - 18
Input/Output Communications.....	6 - 18
Power Supply.....	6 - 19
AC Mains Power Source	6 - 19
Battery Power.....	6 - 19
Data Storage	6 - 20
Printers.....	6 - 21
Physical Characteristics	6 - 21

Environmental and Safety Characteristics.....	6 - 22
Warranty Statements.....	6 - 28
Phone Numbers and How To Get Assistance.....	6 - 29
Manufacturer's Responsibility	6 - 29

This page intentionally left blank.

Foreword

The **Trio** Operating Instructions are intended to provide information for proper operation.

General knowledge of monitoring and an understanding of the features and the functions of the **Trio** Monitor are prerequisites for proper use.

Do not operate this monitor before reading these instructions.

Information for servicing this instrument is contained in the **Trio** Monitor Service Manual, (Part Number 0070-00-0627-03). For additional information or assistance, please contact a service representative in your area.

CAUTION: U.S. Federal Law restricts this device to sale by or on the order of a physician or other practitioner licensed by U.S. state law to use or order the use of this device.

Patents: This device is covered under one (1) of more of the following U.S. patents and any foreign equivalents 4,621,643; 4,700,708; 4,770,179; 4,869,254; 4,653,498; 4,928,692; 4,934,372; 4,960,126; 5,078,136; 5,482,036; 5,490,505; 5,632,272; 5,685,299; 5,743,263; 5,758,644; 5,769,785; 6,157,850; 6,206,830; 4,802,486; 5,351,685; 5,421,329; 5,485,847; 5,533,507; 5,577,500; 5,803,910; 5,853,364; 5,865,736; 6,035,223; 6,263,222; 6,298,252; 6,463,310; 6,591,123; 6,675,031; 6,708,049; 6,801,797; 6,083,172 Re. 35,122. Possession or purchase of this device does not convey any express or implied license to use this device with replacement parts which would, alone, or in combination with this device, fall within the scope or one (1) or more of the patents related to this device.

Warnings, Precautions And Notes

Please read and adhere to all warnings, precautions and notes listed here and in the appropriate areas throughout this manual.

A **WARNING** is provided to alert the user to potential serious outcomes (death, injury, or serious adverse events) to the patient or the user.

A **CAUTION** is provided to alert the user to use special care necessary for the safe and effective use of the device. They may include actions to be taken to avoid effects on patients or users that may not be potentially life threatening or result in serious injury, but about which the user should be aware. Cautions are also provided to alert the user to adverse effects on this device of use or misuse and the care necessary to avoid such effects.

A **NOTE** is provided when additional general information is applicable.

Warnings

- WARNING:** Equipment not suitable for use in the presence of a flammable anesthetic mixture with air or with oxygen or with nitrous oxide.
- WARNING:** The AC line cord and interface cables (i.e. non-patient cables) may utilize the same ground. Therefore, removal of the AC line cord does not necessarily isolate the Trio, if non-patient interface cables are attached.
- WARNING:** Observe extreme caution when a defibrillator is used on a patient. Do not touch any part of patient, table or monitor when a defibrillator is in use.
- WARNING:** Route cables neatly. Ensure cables, hoses, and wires are away from patient's neck to avoid strangulation. Keep floors and walkways free of cables to reduce risk to hospital personnel, patients and visitors.
- WARNING:** This monitor is not intended for use in an MR environment.
- WARNING:** When using electrosurgery equipment, leads should be placed equidistant from electrosurgery electrotome and the grounding plate to avoid cautery. Ensure that wires from electrosurgery equipment and ECG cables do not become tangled.
- WARNING:** The Trio monitor is intended for hospital use under the direct supervision of a licensed health care practitioner.
- WARNING:** Ensure that the conductive parts of ECG electrodes do not contact other conductive parts, including earth ground.
- WARNING:** Pacemaker patients' rate meters may continue to count the pacemaker rate during occurrences of cardiac arrest or some arrhythmias. Do not rely entirely upon rate meter alarms. Keep pacemaker patients under close surveillance. See Appendix section of this manual for disclosure of the pacemaker pulse rejection capability of this instrument.
- WARNING:** Do not clean the monitor or sensors while it is on and/or connected to AC power.
- WARNING:** Ensure that the ECG lead wires are neatly secured in a manner that will prevent them from encircling the patient's neck, creating a strangulation hazard.
- WARNING:** Perform the decontamination process with the unit powered down and power cord removed.

Precautions

- CAUTION:** The use of portable and mobile RF communications equipment, in the proximity of the Trio, can affect the performance of this monitor.
- CAUTION:** The use of unapproved accessories may diminish monitor performance.
- CAUTION:** The Trio should not be used adjacent to or stacked with other equipment. If adjacent or stacked use is necessary, the Trio should be observed to verify normal operation in the configuration in which it will be used.
- CAUTION:** Operation of the Trio below the minimum amplitude or value of PATIENT physiological signal may cause inaccurate results (see section 6.0, Appendix).
- CAUTION:** When using electrosurgery equipment, never place an electrode near the grounding plate of the electrosurgery device. This may create interference with the ECG signal.
- CAUTION:** The patient size selection should be matched to the actual patient before monitoring begins.
- CAUTION:** To avoid possible damage to the Trio, use only approved ECG cables and approved accessories.
- CAUTION:** Line isolation transients may resemble actual cardiac waveforms, thus inhibiting heart rate alarms. Check lead wires for damage and ensure good skin contact prior to and during use. Always use fresh electrodes and follow proper skin preparation techniques.
- CAUTION:** Use of accessories, transducers and cables other than those specified in the manual may result in increased Electromagnetic Emissions or decreased Electromagnetic Immunity of the Trio. It can also cause delayed recovery after the discharge of a cardiac defibrillator.
- CAUTION:** Thoracic respiration measurement may interfere with some pacemakers. Refer to the pacemaker's manufacturer supplied manual.
- CAUTION:** If a 3 Lead cable is used when a unit is set to 5 lead mode, no ECG signal will be obtained. If a 5 lead cable is used when the unit is set to 3 lead mode only Lead I, II and III are operable.
- CAUTION:** Do not place the SpO₂ sensor on an extremity with an invasive catheter or blood pressure cuff in place.
- CAUTION:** Tissue damage or inaccurate measurement may be caused by incorrect sensor application or use, such as wrapping too tightly, applying supplemental tape, failing to inspect the sensor site periodically or failing to position appropriately. Carefully read the sensor directions and all precautionary information before use.
- CAUTION:** Excessive ambient light may cause inaccurate measurements. In such cases, cover the sensor site with opaque material.

- CAUTION:** Inaccurate SpO₂ measurements may be caused by:
- incorrect sensor application or use
 - significant levels of dysfunctional hemoglobins, (e.g., carboxyhemoglobin or methemoglobin)
 - intra-vascular dyes such as indocyanine green or methylene blue
 - exposure to excessive illumination such as surgical lamps (especially ones with a xenon light source), bilirubin lamps, fluorescent lights, infrared heating lamps, or excessive ambient light. In such cases, cover the sensor site with opaque material.
 - excessive patient movement
 - venous pulsations
 - electro-surgical interference
 - placement of a sensor on an extremity that has a blood pressure cuff, arterial catheter or intra-vascular line.
 - nail polish or fungus
- CAUTION:** In certain situations in which perfusion and signal strength are low, such as in patients with thick or pigmented skin, inaccurately low SpO₂ readings will result. Verification of oxygenation should be made, especially in preterm infants and patients with chronic lung disease, before instituting any therapy or intervention.
- CAUTION:** Many patients suffer from poor peripheral perfusion due to hypothermia, hypovolemia, severe vasoconstriction, reduced cardiac output, etc. These symptoms may cause a loss in vital sign readings.
- CAUTION:** If the sensor or patient cable are damaged in any way, discontinue use immediately. To prevent damage, do not soak or immerse the sensor in any liquid solution. Do not attempt to sterilize.
- CAUTION:** When equipped with Masimo SpO₂, use only Masimo oxygen sensors and cables. Use of other oxygen sensors may cause improper oximeter performance.
- CAUTION:** When equipped with Nellcor SpO₂, use only Nellcor oxygen sensors and cables. Use of other oxygen sensors may cause improper oximeter performance.
- CAUTION:** When using the Trio equipped with SpO₂, use only approved supplied oxygen transducers and Patient Cables. Use of other oxygen transducers may cause improper oximeter performance.
- CAUTION:** Use only approved blood pressure cuffs and hoses with the Trio.
- CAUTION:** Please consult a physician for interpretation of blood pressure measurements.
- CAUTION:** A blood pressure measurement can be affected by the position of the patient, and his/her physiological condition as well as other factors, such as patient movement.

- CAUTION:** A patient's skin is sometimes fragile (i.e. on pediatric and geriatric patients or due to physiological conditions). In these cases, a longer time duration between measurements should be considered to decrease the number of cuff inflations over a period of time. In extreme cases, a thin layer of soft roll or cotton padding may be applied to the limb in order to cushion the skin when the cuff is inflated. This measure may affect NIBP performance and should be used with caution.
- CAUTION:** Observe caution on all patients (Pediatrics and Adults) when NIBP is set to the Continuous mode and the 1 minute Interval. When the NIBP "Continuous" interval is chosen, the Trio will continually take back to back blood pressure readings. As a safety precaution, a limit is placed on the Continuous mode to revert to an interval of every 5 minutes after 5 minutes of continuous readings.
- CAUTION:** Any condition which may affect the regularity and strength of arterial pressures (such as patient movement, cardiac arrhythmias, restriction of hose, etc.), will affect the accuracy and ability to measure the NIBP.
- CAUTION:** When cleaning sensors, do not use an excessive amount of liquid. Wipe the sensor surface with a soft cloth, dampened with a cleaning solution.
- CAUTION:** Do not subject the sensor to autoclaving.
- CAUTION:** Do not use sensors or cables that are damaged or have deteriorated.
- CAUTION:** Replace the battery with one of the following part numbers: 0146-00-0043 (for a sealed lead acid battery), 0146-00-0069 (for a Lithium Ion battery).
- CAUTION:** Remove the battery if the Trio is not likely to be used for an extended period of time.
- CAUTION:** Remove the battery prior to shipping the Trio.
- CAUTION:** To avoid permanent damage, do not expose metal components (pins, sockets, snaps) to disinfectants, soaps or chemicals.
- CAUTION:** The cuff must be properly applied to the patient's limb before inflating. If it is inflated without being securely wrapped, damage to the cuff can result.
- CAUTION:** Only connect NIBP Luer fittings to Blood Pressure Cuff or Monitor.
- CAUTION:** During the decontamination process, do not get the LpH SE Germicidal detergent into any vent openings.
- CAUTION:** To ensure continued use of the Factory Defaults when the unit is powered off and on, save the Factory Defaults as the User Default Configuration (see section 3.1.2).

CAUTION: Prolonged and continuous monitoring may increase the risk of skin erosion and pressure necrosis at the site of the sensor. Check the SpO₂ sensor site frequently to ensure proper positioning, alignment and skin integrity at least every eight (8) hours; with the Adult and Pediatric re-usable finger sensor, check every four (4) hours; for patients of poor perfusion or with skin sensitive to light, check every 2 - 3 hours; more frequent examinations may be required for different patients. Change the sensor site if signs of circulatory compromise occur.

Notes

- NOTE:** Potential hazards due to errors in software or hardware have been minimized by actions taken in accordance with IEC 60601-1.
- NOTE:** Messages are provided to assist in the identification and correction of problems that may occur with the monitor.
- NOTE:** Should the device become accidentally saturated with any liquid, immediately discontinue use and contact Customer Service.
- NOTE:** The comparison testing conducted via the auscultatory method used both Phase 4 and Phase 5 Korotkoff sounds. Reports of study findings for both the auscultatory method as well as the intra-arterial methods are available by contacting Technical Support (201) 995-8116.
- NOTE:** Only operate this device within the specified operating signal range.

Indication For Use















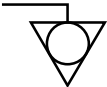

The **Trio™** monitor is intended for use in healthcare settings under the direct supervision of a licensed healthcare practitioner. The intended use of the monitor is to monitor physiologic parameter data on adult and pediatric patients. Physiologic data includes: electrocardiogram, invasive blood pressure, non-invasive blood pressure (NIBP), pulse oximetry, heart rate (derived from ECG, SpO₂, or NIBP), respiration and temperature as summarized in the operating instructions manual. The information can be displayed, stored, trended and printed.

The monitor is not intended for home use. The monitor is not intended to be an apnea monitor. It was not designed or validated for use as an apnea monitor.

Unpacking

Remove the instrument and accessories from the shipping cartons and examine them for signs of shipping damage. Save all packing materials, invoice and bill of lading. These may be required to process a claim with the carrier. Check all materials against the packing list. Contact your Sales Representative or Distributor for assistance in resolving shipping problems.

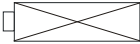
Symbols

SYMBOL	DESCRIPTION	SYMBOL	DESCRIPTION
	Attention, Consult Accompanying Documents / Refer to Manual		Type BF Equipment
	Dangerous Voltage		Defibrillator Proof Type BF Equipment
	Equipotentiality		Defibrillator Proof Type CF Equipment
	Alternating Current (AC)		Alarm Off
	ON/OFF (only for a part of the equipment)		Alarm Mute
	Battery Charging		Full Battery Indicator
	Data Output		Low Battery Indicator
	Data Input/Output		No Battery in Unit
	NIBP Connection		Non-ionizing electromagnetic radiation

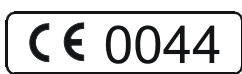

A symbol designating compliance of the **Trio** monitor with the Medical Device Directive (MDD) 93/42/EEC, Class II b device.

General Product Description

The **Trio** is a vital signs monitor intended for intra-hospital use on human patients. It is adaptable for use with adult and pediatric patients. The **Trio** is a three (3) to four (4) trace monitor. The unit has many features and functions, yet is easy to use through an integrated keypad, Navigator™ Knob (see FIGURE 1-2) and an intuitive menu system. Refer to Front Panel Keypad for details.

The patient parameters that can be monitored with the **Trio** are: ECG (3-lead or 5-lead selectable), SpO₂, Non-Invasive Blood Pressure, Respiration and Temperature.

The **Trio** is equipped with an 8.4" Color High Resolution (800 x 600) TFT LCD. Digital displays are provided for Heart Rate, Pulse Rate, Pulse Oximetry (SpO₂), Non-Invasive Blood Pressure (NIBP), Respiration Rate and Temperature (T1). Waveform displays are provided for ECG, Pleth and Respiration. An optional digital and waveform display for Invasive Blood Pressure (IBP) is available. The optional built-in thermal recorder provides hard copies of all digital data and waveforms, as well as Tabular and Graphic Trend information.

The **Trio** monitor can be mounted on a rolling stand, a wall mount bracket, a bed rail or operated as a tabletop device.

The **Trio** is powered by an AC connection or an optional internal battery.

NOTE: **The Trio is suitable for use in the presence of the discharge of a defibrillator.**

NOTE: **The Trio is suitable for use in the presence of electrosurgery.**

NOTE: **The Trio may not meet performance specifications if stored or used outside of the specified environmental conditions (see section 6.0).**

Key Features

The **Trio** offers several new features that enhance the capabilities of the monitor. The main improvements of this release are as follows:

- Support for the full line of adult and pediatric NIBP Cuffs, see Section 5.
- Determination of heart rate from an NIBP measurement, see Section 2.
- An enhancement to SpO₂ monitoring that enables audible distinction of oxygen saturation changes, see Section 2.
- A serial port that offers connectivity to various medical devices, see Section 1.

FEATURES	STANDARD	OPTIONAL
Display	8.4 inch color TFT LCD 4-trace erase bar refresh	
ECG	3 or 5 Lead (I, II, III, aVR, aVL, aVF, V) ECG Cascade ESIS Capability (3 or 5 Lead)	
Blood Pressure	Non-Invasive Blood Pressure	
SpO ₂	Masimo SET® SpO ₂	Nellcor® OxiMax® SpO ₂
Respiration	Impedance	
Temperature	One YSI 400 channel	
Trend	Tabular and Graphic Trends up to 24 hours*	
Power	Internal isolated power module	Sealed lead acid battery or Lithium Ion battery
Printing		Two-trace recorder
Communication	Ethernet, Serial Communication Port (DIAP), ** Analog Output	
Other	Handle with bedrail hook Navigator™ Knob Dedicated keys	Wall mount and rolling stand kits

* When the monitor is powered OFF, the tabular and graphic trend data is maintained for 2 hours. If the monitor remains OFF for more than 2 hours, the tabular and graphic trend data is deleted.

** Model number 0998-00-0600-4XXXX only

1.1 Front Panel

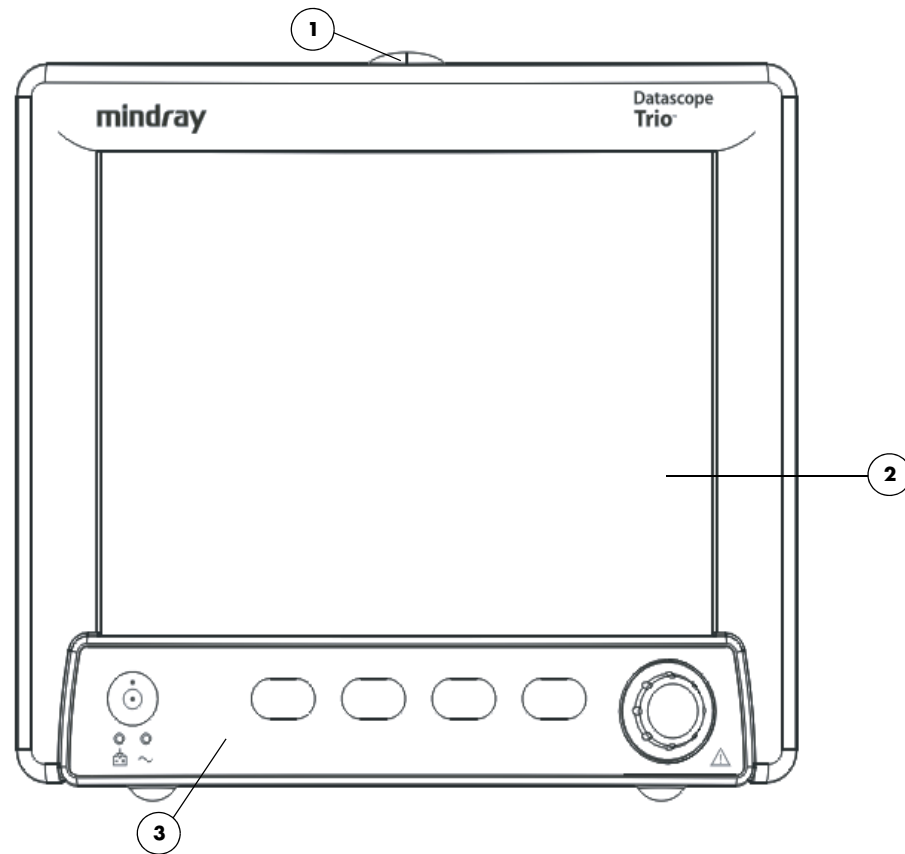

FIGURE 1-1 Front View of Monitor

1. Alarm Light

Illuminates when an alarm is triggered.

2. Display

8.4" color TFT LCD (800 x 600 resolution).

3. Front Panel Keypad

Navigator™ Knob and dedicated quick-action keys.

1.1.1 Front Panel Keypad

The front panel keypad is used to access many main functions quickly and easily (see FIGURE 1-2).

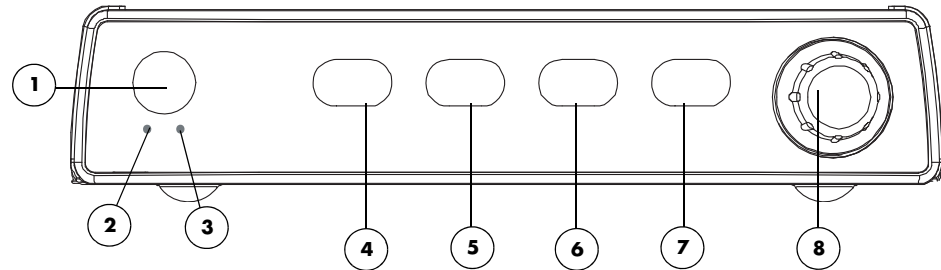



FIGURE 1-2 Keypad

- | | |
|---|--|
| <p>1. POWER</p> | <p>Press this key to power the Trio ON or OFF.</p> <p>NOTE: The power supply and battery charger are active any time AC power is supplied, regardless of whether the monitor is ON or OFF.</p> |
| <p>2. BATTERY CHARGING INDICATOR</p> | <p>A green LED that is illuminated when AC power is present and the battery is installed and charging. When the monitor is running on battery power, this LED does not illuminate. When a "low battery" condition exists, this LED flashes at a constant rate.</p> |
| <p>3. AC POWER INDICATOR</p> | <p>A green LED that is illuminated when AC power is present.</p> |
| <p>4. NIBP</p> | <p>Press this key to begin a NIBP measurement. During a measurement, press this key to cancel the measurement and deflate the cuff.</p> |
| <p>5. PRINT</p> | <p>Press this key to initiate a real-time printout of numeric data and selected waveforms. Results are output via the optional internal printer. During a printing, press this key to cancel the print job. Various print settings (such as speed and duration of printout) are adjustable and may be set by accessing the PRINTER SETUP menu in the MONITOR SETUP menu. (Refer to section 2.3.5.3 for details).</p> |

-
- 6. ALARM MUTE** Press this key to suspend audio alarms on all currently alarming parameters. The alarms remain suspended for a user selected amount of time as set in the **ALARM SETUP** menu or until the alarm condition is no longer present. Any new alarms that occur while the alarm tone is silenced will disable the silence and sound the alarm tone. While the alarms are suspended, an **ALARM MUTE** icon  is displayed in the message bar. When in **ALARM MUTE** mode, press this key again to re-enable the audio alarm.
- 7. NORMAL SCREEN** Press the key to close all open menus and return the normal real-time display.
- 8. NAVIGATOR™ KNOB** Rotate this knob to highlight the various menus on the display. When highlighted, the menu target will display as black text on a white background. Available menu targets on the main display include the **MENU** icon, ECG lead, ECG size, ECG filter, IBP label, ECG, NIBP, SpO2, IBP, RESP and TEMP. Press the knob to display the highlighted menu. Once a menu is displayed, rotate the knob to highlight one of the items listed. Press the knob to select the highlighted item.
- When it is not highlighted, the **MENU** icon will display as white text on the footer background with a white outline. When all other menu targets are not highlighted, they will be displayed in the colors that are defined in the **PARAMETER COLORS** menu.
 - When navigating within a menu, the menu target will display as black text on a white background. When the menu target is selected by pressing the knob, it will display as follows:
 - If the menu target is a Drop-Down Box, it will open with the current selection displayed in black text on a white background. Rotate and press the knob as necessary to make a selection.
 - If the menu target is a Text Edit Box, a cursor will be inserted in the menu target and the letter "A" in the onscreen keypad will display in black text on a white background. Rotate and press the knob as necessary to input the desired text. Select "OK" in the onscreen keypad to accept the text and return the cursor to the Text Edit Box.
 - If the menu target is a Spin Edit Box, it will display as white text on a black background. Rotate and press the knob as necessary to make a selection.

1.1.2 Display

The **Trio** display provides menus, waveforms, parameter information, patient information, and messages. The **Trio** includes various features that enable the user to customize the display. Additionally, the user default feature enables the user to save the customized settings. The display is divided into the following areas (see FIGURE 1-3):

1. Demographics
2. Technical Alarms
3. Waveform Data/Menus
4. Parameter Tiles
5. Status Bar

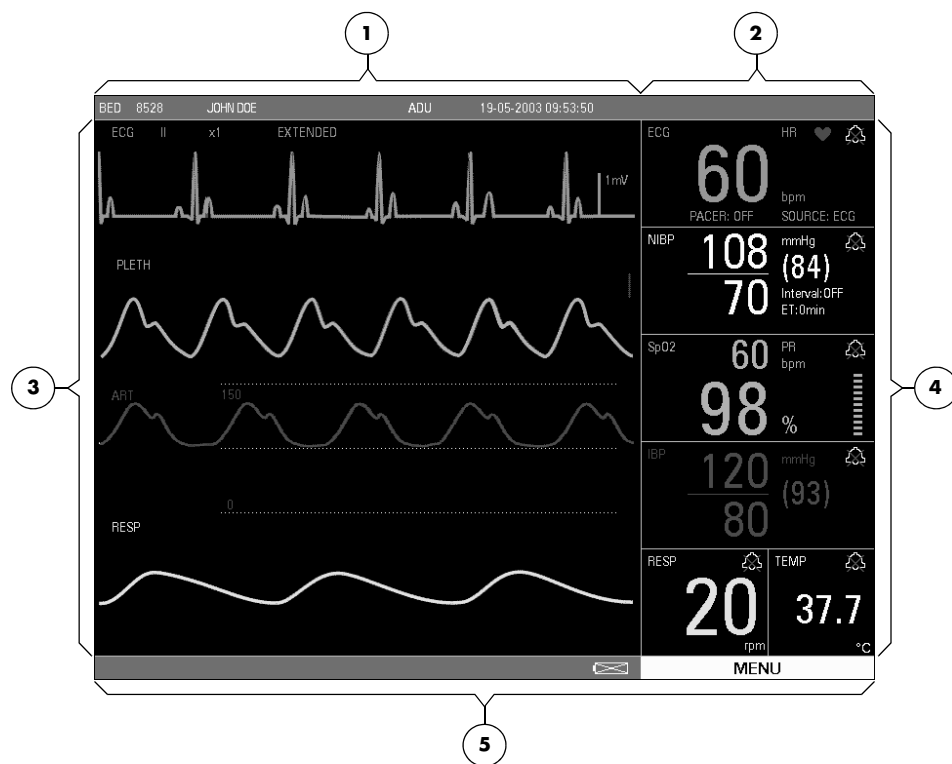

FIGURE 1-3 Main Display

1. Demographics

The demographics area displays the following information:

Bed #	Bed number (6 characters maximum)
First Name	First name of the patient (10 characters maximum)
Last Name	Last name of the patient (10 characters maximum)
Patient Size	Size of the patient: ADU (Adult), PED (Pediatric)

Gender Gender of the patient: M (Male), F (Female)

Current Date XX-XX-XXXX (month-day-year)

**Current Time
(24-hour format)** XX:XX:XX (hours:minutes:seconds)



Indicates that all alarm tones have been manually disabled. It is displayed when the **ALARM MUTE** button is pressed.

2. Technical Alarms

Technical Alarms are failures or errors that require resolution or attention to continue patient monitoring (also called System Error Messages).

3. Waveform Data/Menus

The waveform data/menus area is used to display parameter waveforms and system menus.

Waveform Data

Up to four (4) waveforms may be displayed. When all waveforms are selected in the **TRACE SETUP** menu, the waveforms will be displayed, from top to bottom, as follows: ECG, SpO₂ (Pleth), IBP (optional), Respiration (RESP). (Refer to Trace Setup for details.)

Up to four (4) waveforms may be displayed on this monitor.

- If the parameter waveforms only include ECG, SpO₂ (PLETH), and Respiration (RESP), and the ECG cascade is set to **OFF**, then only three (3) waveforms will be displayed. If the ECG cascade is set to **ON**, then four (4) waveforms will be displayed. The first two (2) will be ECG.
- For those monitors in which IBP is ordered as an option, and the cascade is set to **OFF**, the display will show four (4) waveforms: ECG, SpO₂ (PLETH), IBP, and Respiration (RESP). If the ECG cascade is set to **ON**, then the cascaded ECG will replace the SpO₂ (PLETH) waveform.

ECG Lead, Gain and Filter are displayed in the upper left corner of the main display. The IBP waveform label is displayed in the upper left corner of the IBP waveform window.

The waveforms are refreshed according to the rate designated by the user. (Refer to specific parameter sections for details of sweep speed.)

Menus

When performing menu functions, a menu will be displayed, potentially obstructing the view of select waveforms. Select **NORMAL SCREEN** in the menu (or on the Front Panel Keypad) to exit all menus and return to the normal screen. If the user does not perform any screen operation for 30 seconds, the menu will be removed automatically and the screen will return to the normal display mode. Trend displays do not time out.

4. Parameter Tiles

The numeric data in each parameter tile refreshes continuously, except for the NIBP value, which refreshes each time a measurement is completed (see section 6). Using the **MODULE SETUP** menu, parameters can be turned **ON** or **OFF**, and the screen display will adjust accordingly. The numeric data is displayed at fixed positions within each parameter tile. (see FIGURE 1-4).

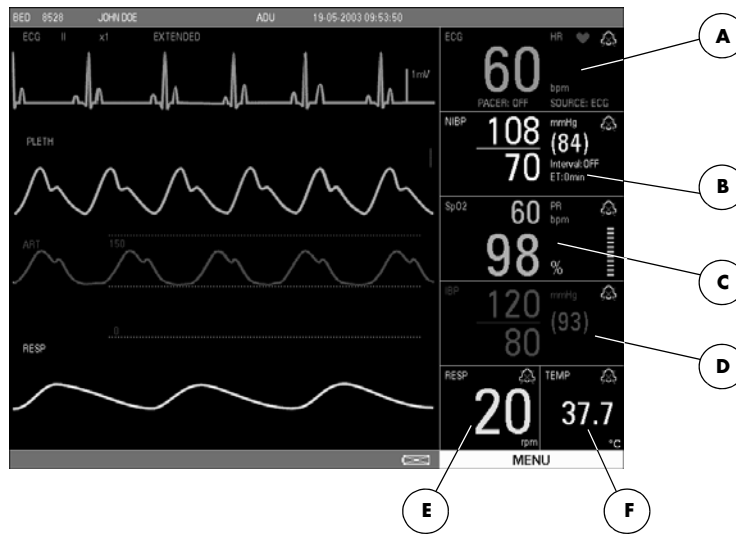

FIGURE 1-4 Parameter Tiles

A. ECG

- PACER Display (**ON** or **OFF**)
- Heart Rate (HR)/Pulse Rate (PR) (Unit: bpm)

B. NIBP

- Systolic, Diastolic, Mean (Units: mmHg or kPa)
- Interval Display (CONT, 1min, 2min, 3min, 4min, 5min, 10min, 15min, 30min, 1HR, 2HRS, 4HRS, OFF)
- Elapsed Time Display (ET)

C. SpO2

- Pulse Rate (PR) (Unit: bpm)
- SpO₂ (Unit: %)
- Pulse Amplitude Indicator

D. IBP

- Systolic, Diastolic, Mean (Units: mmHg or kPa)

E. RESP

- Respiration Rate (Units: rpm)

F. TEMP

- Temperature (Units: °C or °F)

5. Status Bar

The status bar is located at the bottom of the screen. It displays the DEMO MODE status, the battery icons and the **MENU** icon.

- The DEMO MODE status message indicates that the monitor is in demo mode and is displaying simulated patient data.
- The battery icons indicate the relative charge status of the optional battery.

- **Battery (Full)** 

The battery full icon appears in the lower right portion of the display when the unit is operated by battery power. When the batteries are fully charged, the color will be filled in as shown.

- **Battery (Low)** 

The battery low icon appears in the lower right portion of the display when the unit is operating on battery power. When the batteries are running low, color appears only on the right portion of the indicator.

- **No Battery in Unit** 

The no battery icon appears in the lower right portion of the display when a battery is not installed in the monitor.

- The **MENU** icon is used to access the **SYSTEM MENU**. It is a rectangular icon positioned below the parameter tiles and is the same width as that area.

1.2 Left Side Panel

The optional, two-trace thermal strip chart recorder and the battery compartment are located on the left side panel (see FIGURE 1-5).

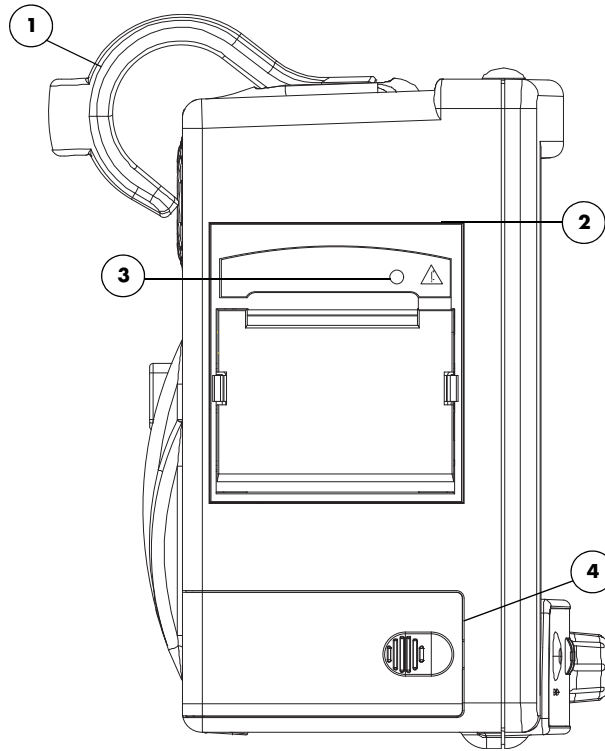

FIGURE 1-5 Left Side Panel

1. Handle/bedrail hook

Handle with integrated bedrail hook

2. Recorder (Optional)

Two-trace thermal strip chart recorder

3. Recorder Power LED

A green LED that indicates that the recorder is receiving power

4. Battery compartment

The housing for the optional, user-replaceable, rechargeable battery (sealed lead acid or Lithium Ion)

1.3 Right Side Panel

The connectors for patient cables and sensors are located on the right side panel (see FIGURE 1-6).

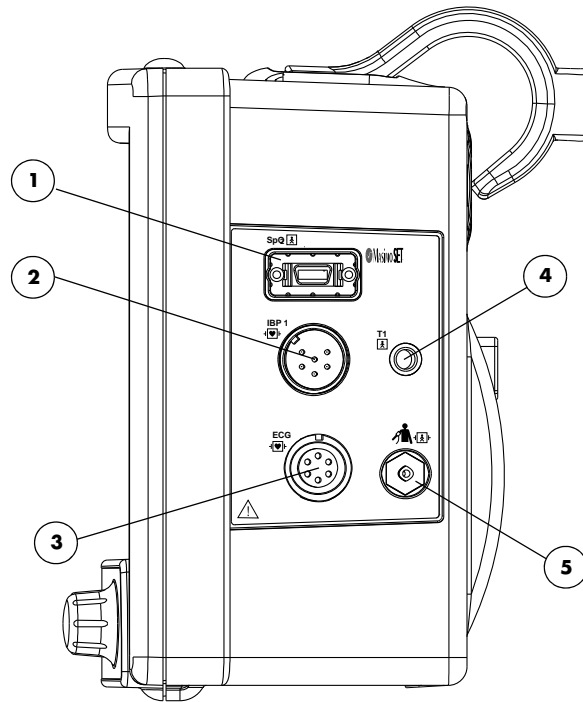

FIGURE 1-6 Right Side Panel

1. SpO₂ Receptacle

This receptacle is used to attach the SpO₂ sensor to the monitor.

2. Optional IBP

A six-pin male receptacle used for an IBP connection.

3. ECG Receptacle

A six position female receptacle used to attach a 3 or 5 Lead ECG cable.

4. T1 Receptacle

A standard 1/4" phone jack is used to mate with the YSI series 400 temperature probe.

5. NIBP Quick-Connect Rectus* Pneumatic Fitting

This pneumatic fitting is used to attach the NIBP hose to the unit.

* *Quick Connect Pneumatic Fittings available from Rectus-TEMA Corporation.*

1.4 Rear Panel

The following connectors are located on the rear panel (see FIGURE 1-7).

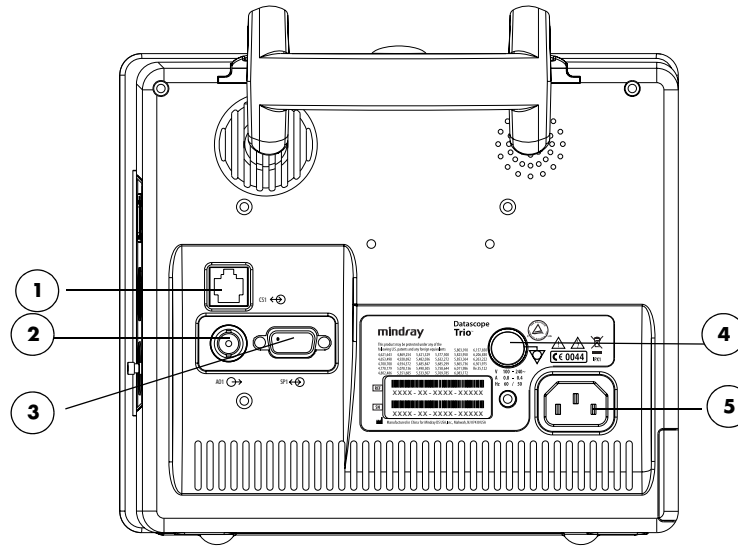

FIGURE 1-7 Rear Panel

1. Ethernet Port (CS1)

The ethernet port is an RJ45 jack that is used for software upgrades.

NOTE: This port should not be used while monitoring a patient.

2. Analog Output (AO1)

The analog signal output connector may be used with a oscilloscope, pen recorder or other external devices (see section 4). The connector is a BNC jack.

NOTE: After connecting any external device to the Analog Output, verify that leakage currents do not exceed accepted limits.

3. Serial Port (SP1) or VGA Output (RD1)

Trio monitors bearing a model number of 0998-00-0600-4XXXX are equipped with a 9-position D-shell serial port connector. Trio monitors bearing a model number of 0998-00-0600-0XXXX or 0998-00-0600-2XXXX are equipped with a 15-position D-Shell VGA output connector.

The proprietary serial port is a 9-position D-shell plug connector with interface based on TIA/EIA-232-F signal compliance. Information is transferred via DIAP protocol. (For additional information see P/N 0070-00-0307).

The VGA output connector provides connectivity to a medical grade remote display. The connector is a 15-position D-Shell connector. Connection to this port should be made with the monitor power OFF. Power ON the monitor after powering ON the remote display.

NOTE: **After connecting any external device to the Serial Port or the VGA Output, verify that leakage currents do not exceed accepted limits.**

4. Equipotential Lug

The equipotential lug provides equipotential grounding for hospital equipment.

NOTE: **Ensure that when connecting external devices to the unit all equipotential terminals are connected.**

5. AC Receptacle

Insert the AC power cord into this receptacle.

This page intentionally left blank.

2.1 Getting Started

The **Trio** features default factory settings that enable monitoring to begin without setting waveforms, parameters, alarms, or functions. Each of these settings can be changed based on specific patient or departmental needs. Certain operating characteristics (e.g. NIBP start pressure) are based on the selected patient size.

CAUTION: The patient size selection should be matched to the actual patient before monitoring begins.

Before using the monitor, complete the following steps:

1. Examine the device, all external cables, inserted modules and accessories for damage
2. Check all monitor functions for proper operation.

NOTE: If the monitor is damaged, contact the biomedical engineer of the hospital or Customer Service immediately.

2.1.1 Setting-up Patients

1. Turn the monitor ON using the **POWER** key on the front panel.
2. Remove all of the previous patient data (except BED # and SIZE) as follows:
 - a. Use the Navigator™ Knob to select the **MENU** icon located in the bottom right corner of the screen. The **SYSTEM MENU** (FIGURE 2-1) is displayed.
 - b. From the **SYSTEM MENU**, select **PATIENT SETUP**. The **PATIENT SETUP** menu (FIGURE 2-2) is displayed.
 - c. Select **PATIENT DISCHARGE**. A confirmation dialog is displayed with the prompt, **Discharge patient from monitor?**
 - d. Select **YES** to remove the previous patient data from the monitor.
3. Connect the patient to the monitor, apply appropriate accessories such as ECG electrodes, NIBP cuff, SpO₂ probe, etc.

4. Enter the desired patient information into the **Trio** via the **PATIENT SETUP** menu. Select appropriate patient **SIZE**.
5. If desired, press the **NIBP** key to initiate a non-invasive blood pressure measurement.
6. When monitoring has concluded, clear the patient's data by selecting **PATIENT DISCHARGE** from the **PATIENT SETUP** menu.

2.1.2 Setting the Clock (Date and Time)

From the **MONITOR SETUP** menu the date and time can be set.

1. Using the Navigator Knob, select the **MENU** icon located in the bottom right corner of the display.
2. From the **SYSTEM MENU** select **MONITOR SETUP**.
3. Select **TIME SETUP**.
4. Select **YEAR, MONTH, DAY, HOUR, MINUTE** or **SECOND** and adjust accordingly.
5. Select **PREVIOUS MENU** to return to the previous menu or select **NORMAL SCREEN** (from the menu or the Front Panel Keypad) to exit the menu and return to the normal screen.

2.2 Menus

The **Trio** menu system is accessed using the Navigator™ Knob. The flexibility of the menu system enables the configuration of various features including the monitored parameters, waveform sweep speed, audio volume, and parameter colors.

The **MENU** icon located in the bottom right corner of the display provides access to the **SYSTEM MENU**. The parameter menu label in each parameter tile provides access to its user-definable settings. Parameter menus include: **ECG, NIBP, SpO2, IBP** (optional), **RESP** and **TEMP**.

The menu system restricts the overlap of settings that adjust upper and lower alarm limits. The menu targets for these limits will be Spin Edit Boxes. See the following example for further explanation.

Example: if a lower limit is set to 82, the menu system will restrict the upper limit choices from being 82 or less.

NOTE: **All menus time-out after 30 seconds of inactivity with the exception of the List Trend and Graphic Trend menus, which display indefinitely until closed manually.**

2.3 System Menu

The **SYSTEM MENU** provides the following submenu choices: **PATIENT SETUP**, **LIST TREND**, **GRAPHIC TREND**, **MARK EVENT**, **MONITOR SETUP**, **MAINTENANCE**, and **NORMAL SCREEN**. For the default settings of all menu selections, refer to section 3.0, "Defaults".

Use the Navigator Knob to select the **MENU** icon in the lower right corner of the screen. The **SYSTEM MENU** (FIGURE 2-1) is displayed. From the **SYSTEM MENU**, select a submenu.

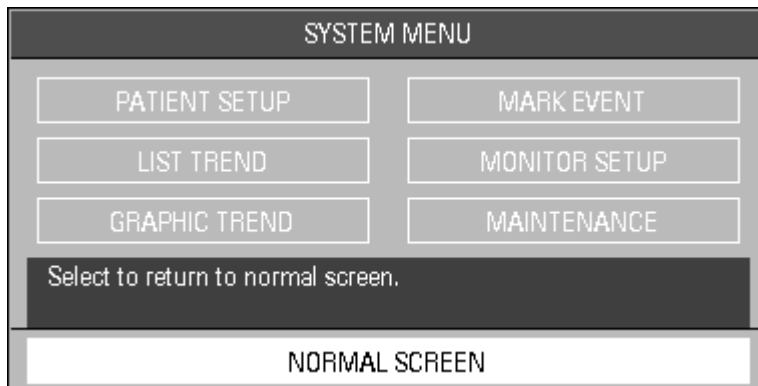

FIGURE 2-1 System Menu

2.3.1 Patient Setup

Select **PATIENT SETUP** from the **SYSTEM MENU**. The **PATIENT SETUP** menu (FIGURE 2-2) is displayed.

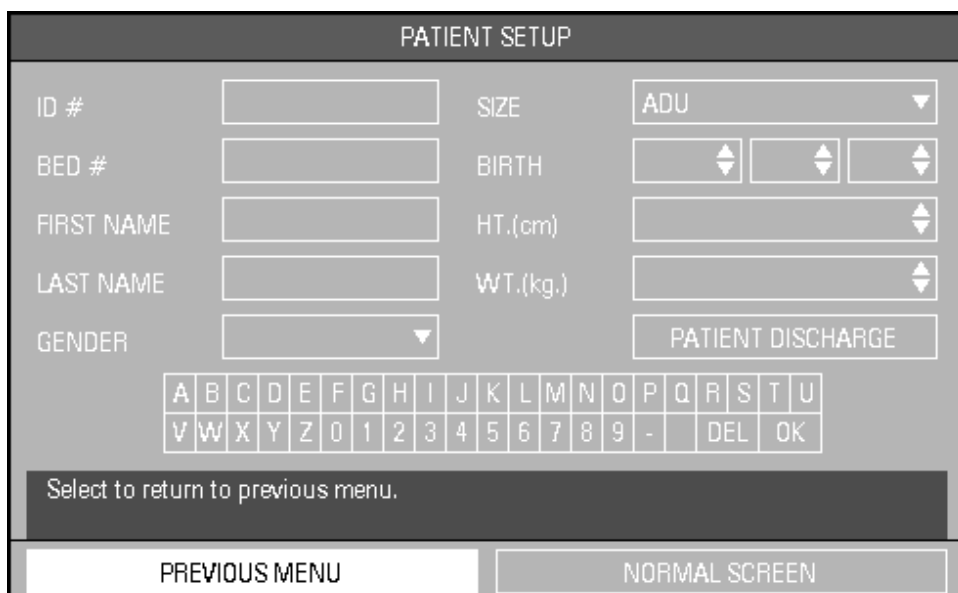

FIGURE 2-2 Patient Setup Menu

The **PATIENT SETUP** menu provides the following choices for entering patient demographic information and for patient discharge.

NOTE: The **ID #**, **BED#**, **FIRST NAME** and **LAST NAME** use the on-screen keypad to enter demographic information. The remaining demographic information is chosen from Drop-Down or Spin Edit Boxes.

ID # Select to enter the patient ID number (only appears on recorder printouts)

BED# Select to enter the patient bed number

FIRST NAME Select to enter the patient's first name

LAST NAME Select to enter the patient's last name

GENDER Select to enter the patient gender (choices are: **F** for Female, **M** for Male)

SIZE Select to enter the patient size (choices are: **ADU** for Adult and **PED** for Pediatric)

BIRTH Select to enter the patient date of birth (format: **year/month/day**)

HT. (cm) Select to enter the patient height

WT. (kg) Select to enter the patient weight

PATIENT DISCHARGE Select to discharge the current patient and admit a new patient. Selecting **PATIENT DISCHARGE** opens the confirmation dialog box (FIGURE 2-3). The user is prompted to answer **YES** or **NO** to the question: **Discharge patient from monitor?**

Select **YES** to discharge the current patient from the monitor, erase the stored record of the current patient (except **BED #** and **SIZE**) and exit the menu. Select **NO** to continue monitoring the current patient, maintain the stored record of the current patient and exit the menu.

NOTE: Selecting **YES** will delete all information related to the currently monitored patient.

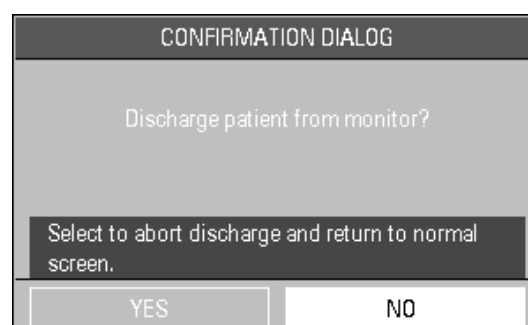

FIGURE 2-3 Confirmation Dialog Box

Entering the ID #, BED#, FIRST NAME and LAST NAME

Use the onscreen keypad to enter the ID #, BED#, FIRST NAME and LAST NAME information, proceed as follows:

1. Select the **PATIENT SETUP** menu and use the Navigator™ Knob to scroll to the item that will be entered or changed.
2. Press the Navigator Knob and the cursor will automatically move to the on-screen keypad.
3. Move the cursor to the appropriate character and press the knob so that the character appears in the box above. Continue this technique until the information for that item is complete.

NOTE: Select **DEL** to delete incorrect characters.

4. When finished entering the data for a particular item, select **OK**. The patient information will be displayed in the box for that menu item and the cursor will return to the starting position.
5. Select **PREVIOUS MENU** to return to the previous menu. Select **NORMAL SCREEN** (from the menu or the Front Panel Keypad) to exit the menu and return to the normal screen.

Entering the GENDER, SIZE, BIRTH DATE, HEIGHT and WEIGHT.

Use the Drop-Down and Spin Edit Boxes to enter the GENDER, SIZE, BIRTH, HT. and WT. information, proceed as follows:

NOTE: Setting the **SIZE** will automatically select all user defined defaults for that patient size.

1. Select the **PATIENT SETUP** menu and use the Navigator™ Knob to scroll to the item that will be entered or changed.
2. Press the Navigator Knob to access the Drop-Down or Spin Edit box for that selection.
3. Scroll to the desired setting and press the knob to accept the selection.
4. Select **PREVIOUS MENU** to return to the previous menu. Select **NORMAL SCREEN** (from the menu or the Front Panel Keypad) to exit the menu and return to the normal screen.

2.3.2 List Trend

To access the **LIST TREND** menu/display, select **LIST TREND** from the **SYSTEM MENU**. Refer to "Trends" on page 2-76 for details on List Trend functions.

2.3.3 Graphic Trend

To access the **GRAPHIC TREND** menu/display, select **GRAPHIC TREND** from the **SYSTEM MENU**. Refer to "Trends" on page 2-76 for details on Graphic Trend functions.

2.3.4 Mark Event

The **Mark Event** function places a time stamp event marker (A, B, C or D) in the trend memory. This function may be used to identify medication delivery, change in patient status, etc. There may be a time delay between the time at which the event is marked and the point in time at which it displays on the trend screen.

Select **MARK EVENT** from the **SYSTEM MENU** (see FIGURE 2-4).

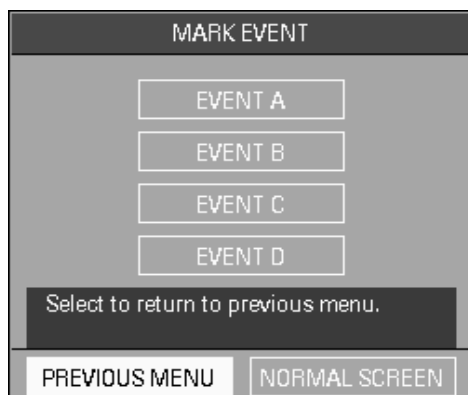

FIGURE 2-4 Mark Event Menu

To mark an event, use the Navigator™ Knob to select **EVENT A**, **B**, **C** or **D**. Once an event is marked, the @ symbol appears in the event box. To cancel the selection, move the cursor to the event and press the knob again. Select **PREVIOUS MENU** to save the marked event, exit the **MARK EVENT** menu and return to the previous menu. Select **NORMAL SCREEN** (from the menu or the Front Panel Keypad) to save the marked event, to exit the menu and return to the normal screen.

NOTE: **Marked Events will not be saved if the menu times out.**

2.3.5 Monitor Setup

1. Select **MONITOR SETUP** from the **SYSTEM MENU**. The **MONITOR SETUP** menu, containing various submenus (FIGURE 2-5), is displayed.

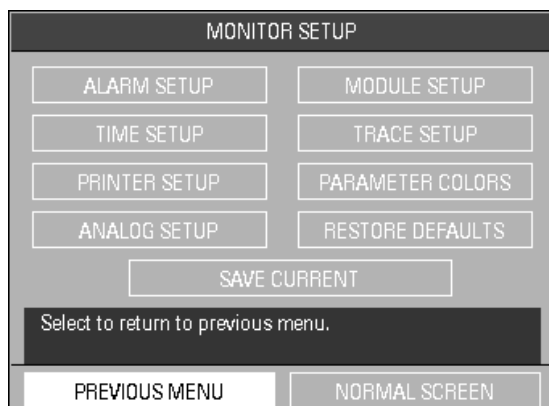

FIGURE 2-5 Monitor Setup Menu

2.3.5.1 Alarm Setup

Select **ALARM SETUP** from the **MONITOR SETUP** menu (see FIGURE 2-5).

The **ALARM SETUP** menu allows the user to adjust various alarm functions. Refer to section 2.5, "Alarms" for details on Alarm functions.

2.3.5.2 Time Setup

From the **MONITOR SETUP** menu, select the **TIME SETUP** menu to modify the time and date settings displayed on the monitor (see FIGURE 2-6). The **TIME SETUP** menu allows the user to set the **YEAR**, **MONTH**, **DAY**, **HOUR**, **MINUTE** and **SECOND**. Use the Navigator™ Knob to adjust settings accordingly. Select **PREVIOUS MENU** to exit the **TIME SETUP** menu and return to the previous menu. Select **NORMAL SCREEN** (from the menu or the Front Panel Keypad) to exit the menu and return to the normal screen.

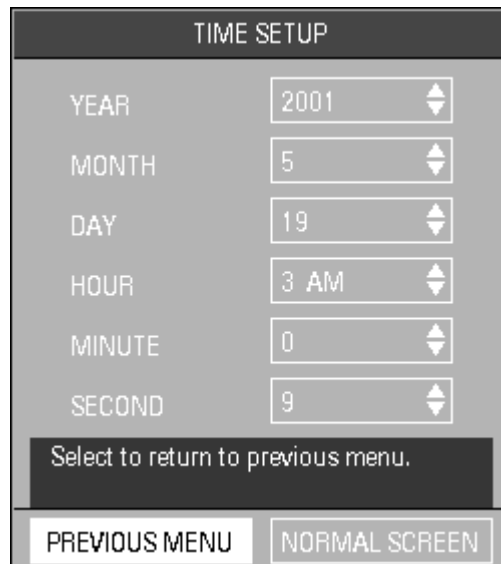

The screenshot displays the 'TIME SETUP' menu. At the top, the title 'TIME SETUP' is centered. Below it, there are six rows of settings, each with a label on the left and a value in a box with up/down arrows on the right: YEAR (2001), MONTH (5), DAY (19), HOUR (3 AM), MINUTE (0), and SECOND (9). Below these settings is a dark grey bar with the text 'Select to return to previous menu.' At the bottom of the screen, there are two buttons: 'PREVIOUS MENU' on the left and 'NORMAL SCREEN' on the right.

FIGURE 2-6 Time Setup Menu

2.3.5.3 Printer Setup

Select **PRINTER SETUP** from the **MONITOR SETUP** (see FIGURE 2-7).



FIGURE 2-7 Printer Setup Menu

Printer Setup Menu Selections

WAVEFORM 1 or WAVEFORM 2 The **PRINTER SETUP** menu allows the user to designate which two (2) parameter waveforms are displayed on the printout as **WAVEFORM 1** and **WAVEFORM 2**. Only waveforms that are displayed on screen are available for selection.

Available parameter waveform selections include:

ECG: ECG waveform

SpO₂: SpO₂ Plethysmogram

IBP: IBP waveform (optional)

RESP: Respiration waveform

OFF: No display for this waveform

NOTE: **Two (2) waveforms can not be set to the same parameter. Attempting to set a duplicate parameter will cause the previous selection to default to the next available parameter waveform.**

TIME **TIME** represents the length of recording time. There are two (2) selections available: **CONTINUAL** and **8s**. **CONTINUAL** means once the user presses the **PRINT** key on the front panel, the recorder will continuously print out the selected waveform(s) until the button is pressed again. **8s** indicates a waveform recording time length of 8 seconds.

INTERVAL **INTERVAL** represents the time interval between the start of recorder activations. The following 10 selections are available: **OFF**, **10min**, **20min**, **30min**, **40min**, **50min**, **1HR**, **2HRS**, **3HRS** and **4HRS**. The system will initiate the print operation according to the selected time interval. All interval waveform printouts are 8 seconds in length.

NOTE: **A real-time printout (based on TIME as described in the previous menu) takes priority over a printout based on INTERVAL.**

SPEED **SPEED** is used to select the speed at which the paper advances in the printer. There are two (2) options: **25.0** and **50.0 mm/s**.

GRID **GRID** is used to select output format: **OFF** produces a printout without a background grid, and **ON** produces a printout with a background grid.

CLEAR PRINT TASK **CLEAR PRINT TASK** is used to clear all print tasks from the recorder. This can be used, for example, when multiple alarm print tasks are triggered simultaneously.

NOTE: **The recorder is optional.**

Select **PREVIOUS MENU** to return to the previous menu. Select **NORMAL SCREEN** (from the menu or the Front Panel Keypad) to exit the menu and return to the normal screen.

2.3.5.4 Analog Setup

The monitor can output an analog waveform from the analog output connector (AO1) on the rear panel.

Select **ANALOG SETUP** from the **MONITOR SETUP** menu (see FIGURE 2-8). Select **ANALOG OUT**, to set analog out to **ON** or **OFF**. Select **ANALOG WAVE** to select the parameter waveform output. Choices are **ECG** and **IBP** (optional).

Select **PREVIOUS MENU** to return to the previous menu. Select **NORMAL SCREEN** (from the menu or the Front Panel Keypad) to exit the menu and return to the normal screen.

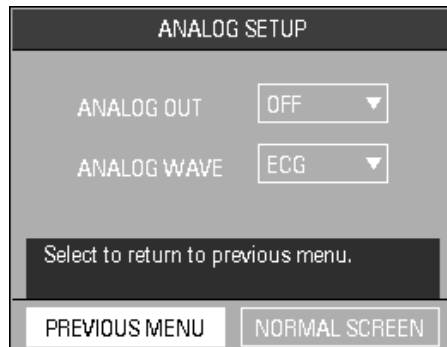

FIGURE 2-8 Analog Setup Menu

2.3.5.5 Module Setup

MODULE SETUP allows the user to customize the display by selecting the parameters to be monitored. Select **MODULE SETUP** from the **MONITOR SETUP** menu (see FIGURE 2-9).

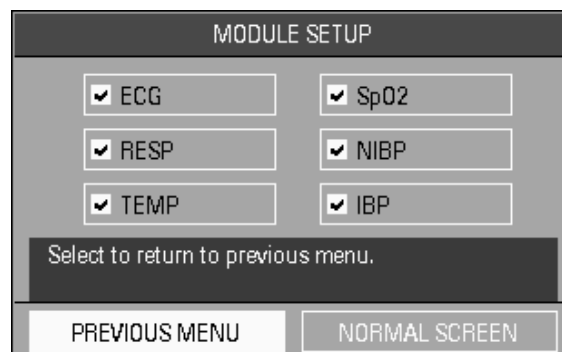

FIGURE 2-9 Module Setup Menu

Select the parameters to monitor by using the Navigator™ Knob to select the item to be displayed. A check mark will be displayed in the box next to each parameter selected. To deselect a parameter, press the knob again (the check mark will be removed). Select **PREVIOUS MENU** to return to the previous menu. Select **NORMAL SCREEN** (from the menu or the Front Panel Keypad) to exit the menu and return to the normal screen.

NOTE: If the optional **IBP** is not installed, it will not be displayed in the **MODULE SETUP** menu.

2.3.5.6 Trace Setup

TRACE SETUP allows the user to choose the traces that will be displayed in the waveform area and to choose the viewing mode. The viewing modes improve the viewability of the display depending on how the **Trio** is positioned for use. There are two viewing modes that can be selected from the **WAVE DISPLAY** pull-down menu.

- **MODE 1** – provides an enhanced view angle and a less smooth wave. This mode should be used when the **Trio** is being viewed from an angle. In most instances, this mode will provide optimal viewing of waveform data. (**MODE 1** is the factory default setting.)
 - **MODE 2** – provides a basic view angle and a smooth wave. This mode should be used when the **Trio** is wall-mounted and being viewed from below.
1. Select **TRACE SETUP** from the **MONITOR SETUP** menu. The **TRACE SETUP** menu (FIGURE 2-10) is displayed.

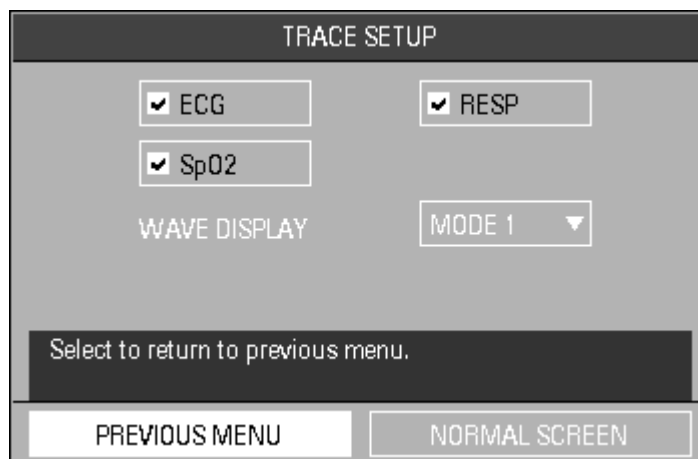

FIGURE 2-10 Trace Setup Menu

2. Use the Navigator™ Knob to select each parameter waveform (a check mark in the box next to a parameter indicates that it has been selected). To deselect a parameter waveform, press the knob again.
3. Choose the desired viewing mode from the **WAVE DISPLAY** pull-down menu.
4. Select **PREVIOUS MENU** to return to the previous menu. Select **NORMAL SCREEN** (from the menu or the Front Panel Keypad) to exit the menu and return to the normal screen.

NOTE: If the optional IBP is not installed, it will not be provided as a choice in the **TRACE SETUP** menu.

2.3.5.7 Parameter Colors

1. Select **PARAMETER COLORS** from the **MONITOR SETUP** menu. The **PARAMETER COLORS** menu (FIGURE 2-11) is displayed. From this menu, the colors for displayed parameters can be selected. The numeric and waveform data for each parameter displays in the same color, as selected by the user. The color choices are: **GREEN, RED, YELLOW, BLUE,** and **WHITE**.

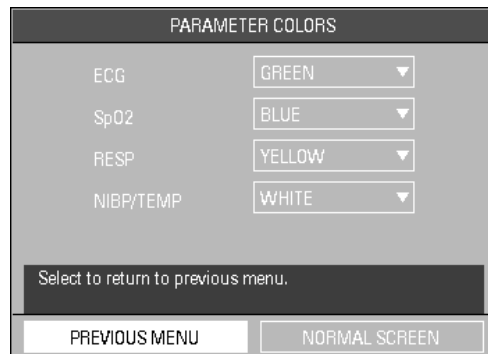

FIGURE 2-11 Parameter Colors Menu

2. Select **PREVIOUS MENU** to return to the previous menu. Select **NORMAL SCREEN** (from the menu or the Front Panel Keypad) to exit the menu and return to the normal screen.

2.3.5.8 Restore Defaults

1. Select **RESTORE DEFAULTS** from the **MONITOR SETUP** menu. The **RESTORE DEFAULTS** menu (FIGURE 2-12) is displayed.

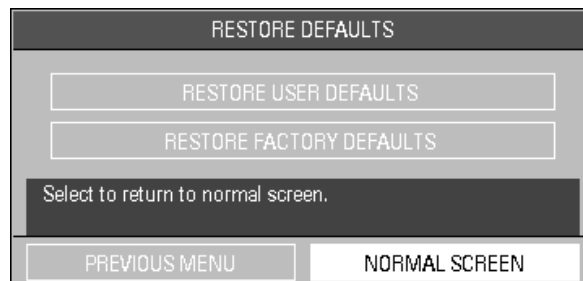

FIGURE 2-12 Restore Defaults Menu

The **RESTORE DEFAULTS** menu allows the user to perform the following two (2) functions:

- The **RESTORE USER DEFAULTS** function allows the user to revert back to a previously saved group of monitor settings for the selected patient size.
 - The **RESTORE FACTORY DEFAULTS** function allows the user to revert back to the group of monitor settings initially set by the manufacturer. Factory alarm defaults for each parameter are indicated in the parameter sections to follow. (See section 3.0 “Defaults” for a complete list of Factory Default Settings.)
2. Select **PREVIOUS MENU** to return to the previous menu. Select **NORMAL SCREEN** (from the menu or the Front Panel Keypad) to exit the menu and return to the normal screen.

2.3.5.9 Save Current

SAVE CURRENT allows the user to save the current customized settings as the default settings (or the **“User Default Configuration”**), replacing the existing user-defined configuration for the current patient size.

1. Select **SAVE CURRENT** from the **MONITOR SETUP** menu. The confirmation dialog box in FIGURE 2-13 is displayed.
2. Select **YES** to replace the existing user-defined configuration with the current customized settings. Select **NO** to cancel the task.

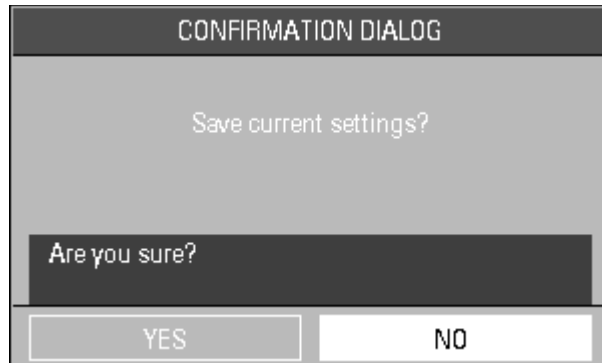

FIGURE 2-13 Confirmation Dialog Box

2.3.6 Maintenance

Refer to the **Trio** Service Manual (Part Number 0070-00-0627-03) for details on maintenance functions.

2.3.7 Normal Screen

Select **NORMAL SCREEN** to exit the **SYSTEM MENU** and return to the normal screen.

2.4 Parameter Menus

2.4.1 Electrocardiogram (ECG) Monitoring

ECG is a continuous waveform of a patient's cardiac electrical activity. The ECG waveform will display in the first waveform area of the **Trio**.

The quality of an ECG signal is directly affected by electrode site skin preparation, electrode patch quality and ECG lead placement. If artifact is present on the ECG waveform, then the arrhythmia processing, alarm processing, and quality of the monitoring function may be affected. The presence of artifact can prevent the monitor from establishing an accurate ECG reference waveform, increasing the difficulty experienced in assessing the ECG rhythm.

Optimizing the ECG signal is imperative for accurate monitoring. Use high quality electrodes, designed to acquire the ECG with excellent base line stability, recovery from defibrillation and minimum artifact from patient movement.

With the **Trio**, ECG can be obtained by using either a 3 Lead or 5 Lead ECG cable in conjunction with a lead set and skin electrodes. For best performance and safety, inspect the ECG cables and electrodes daily.

WARNING: Ensure that the conductive parts of ECG electrodes do not contact other conductive parts, including earth ground.

CAUTION: To avoid possible damage to the Trio, use only approved ECG cables and approved accessories.

CAUTION: Line isolation transients may resemble actual cardiac waveforms, thus inhibiting heart rate alarms. Check lead wires for damage and ensure good skin contact prior to and during use. Always use fresh electrodes and follow proper skin preparation techniques.

CAUTION: Use of accessories, transducers and cables other than those specified in the manual may result in increased Electromagnetic Emissions or decreased Electromagnetic Immunity of the Trio. It can also cause delayed recovery after the discharge of a cardiac defibrillator.

NOTE: This device is not intended for direct cardiac application.

2.4.1.1 Skin Preparation

Proper skin preparation is essential in obtaining an accurate ECG reading. Electrode sites should be clean and dry and should provide a smooth flat surface. Incidental electrical activity and inaccurate readings may arise from incorrect skin preparation.

The following procedure is recommended for secure electrode patch application:

1. Shave the hair from the electrode sites in a circular area with a diameter of 2 – 4 inches.
2. Use a dry gauze pad to remove excess skin oils, skin cells and residue from the electrode sites. Never rub the skin until it is raw or bleeding.

NOTE: Prepare the electrode site with alcohol only if the skin is extremely greasy. If alcohol is used as a drying agent, always allow the skin to dry before placing the electrode patch on the skin.

2.4.1.2 Electrode Patch Location

NOTE: Store electrode patches at room temperature and open just prior to use.

NOTE: Avoid more than one type of electrode on a patient because of variations in electrical resistance.

NOTE: Avoid placing electrode patches directly over bone prominences or over any high activity movement areas such as shoulders or arms because muscle motion produces electrical activity. If an electrode patch is placed over a large muscle such as the pectorals, the monitor may detect this additional muscle activity and could lead to false arrhythmia calls.

1. To prevent evaporation of the contact gel medium, peel the backing off of the electrode patch only when it is ready for use. Visually inspect the contact gel medium for moistness. If the gel medium is not moist, do not use the electrode patch. Dry electrode patches are not conductive.

NOTE: If using the snap type electrode wires, attach the electrode patch to the lead wire before placing patch on the patient.

2. Attach the electrode patch to the skin at the prepared site. Smooth the electrode patch down in a circular motion to ensure proper skin contact. If using soft gel electrodes, never push down directly over the contact gel medium as this may displace the gel and cause monitoring artifact. If using hard gel electrodes, it is recommended that during application, the center of the electrode should be slightly pressed onto the skin to ensure direct contact. Consult the electrode patch manufacturer's instructions for specific use.
3. Secure the lead wires to the patient according to hospital practice. For additional information see section 2.4.1.3, "Lead Placement".

WARNING: Ensure that the ECG lead wires are neatly secured in a manner that will prevent them from encircling the patient's neck, creating a strangulation hazard.

NOTE: It is recommended that electrode patches be changed at least every 24 - 36 hours to maintain proper contact with the skin. Some patients may require electrodes to be changed more often. Electrode patches are disposable and should be applied only once. Try to avoid reusing the exact same electrode site during reapplication. If an electrode becomes wet with fluid, change the electrode patch.

2.4.1.3 Lead Placement

The computerized arrhythmia algorithm works best when the patient's R wave is significantly larger than the P wave or the T wave. If the R wave is not significantly larger than other lower voltage waves on the ECG tracing, the computer may have some difficulty in identifying the appropriate waves. On some patients, electrode patch placement and/or the viewed ECG lead may need to be adjusted in order to obtain a significant R wave.

This section outlines lead placement according to the guidelines of the American Heart Association (AHA) and the International Electro-Technical Commission (IEC).

Standard 3-wire Lead Sets

Standard 3-wire lead sets include 3 ECG leads (I, II and III). Only 1 lead is monitored.

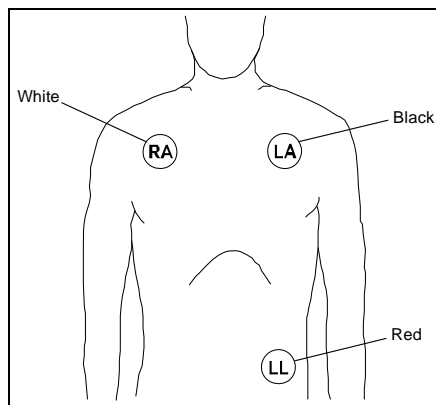

FIGURE 2-14 3-wire Lead Placement (AHA)

- Place the RA (white) electrode under the patient's right clavicle, at the mid-clavicular line within the rib cage frame.
- Place the LA (black) electrode under the patient's left clavicle, at the mid-clavicular line within the rib cage frame.
- Place the LL (red) electrode on the patient's lower left abdomen within the rib cage frame.

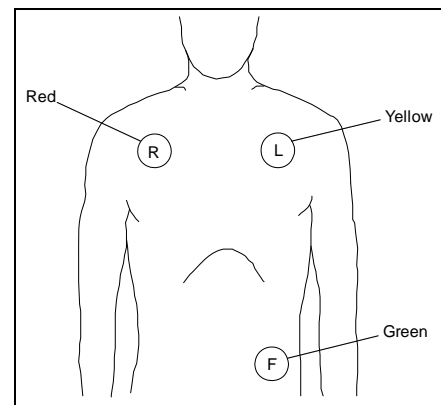

FIGURE 2-15 3-wire Lead Placement (IEC)

- Place the R (red) electrode under the patient's right clavicle, at the mid-clavicular line within the rib cage frame.
- Place the L (yellow) electrode under the patient's left clavicle, at the mid-clavicular line within the rib cage frame.
- Place the F (green) electrode on the patient's lower left abdomen within the rib cage frame.

Standard 5-wire Lead Sets

Standard 5-wire lead sets monitor 7 ECG leads: I, II, III, aVR, aVL, aVF and V.

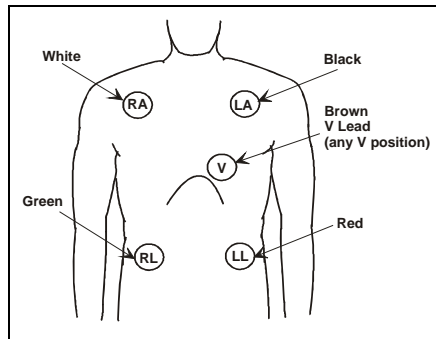

FIGURE 2-16 5-wire Lead Placement (AHA)

- Place the RA (white) electrode under the patient's right clavicle, at the mid-clavicular line within the rib cage frame.
- Place the LA (black) electrode under the patient's left clavicle, at the mid-clavicular line within the rib cage frame.
- Place the LL (red) electrode on the patient's lower left abdomen within the rib cage frame.
- Place the RL (green) electrode on the patient's lower right abdomen within the rib cage frame.
- Place the V (brown) electrode in one of the V-lead positions (V1 – V6) depicted in the following section.

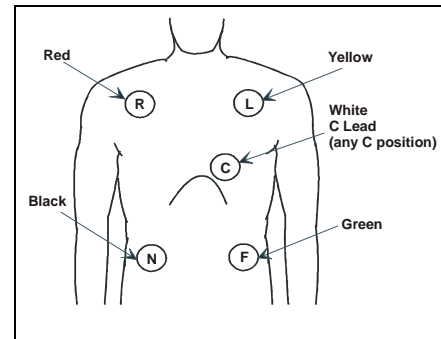

FIGURE 2-17 5-wire Lead Placement (IEC)

- Place the R (red) electrode under the patient's right clavicle, at the mid-clavicular line within the rib cage frame.
- Place the L (yellow) electrode under the patient's left clavicle, at the mid-clavicular line within the rib cage frame.
- Place the F (green) electrode on the patient's lower left abdomen within the rib cage frame.
- Place the N (black) electrode on the patient's lower right abdomen within the rib cage frame.
- Place the C (white) electrode in one of the C-lead (C1 – C6) positions depicted in the following section.

V-Lead and C-Lead Electrode Positions

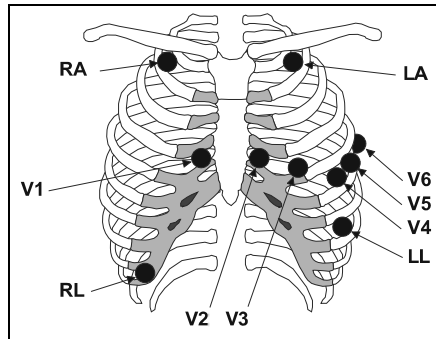

FIGURE 2-18 V-Lead Electrode Placement (AHA)

- V1 - Place the electrode at the fourth intercostal space, on the right sternal border
- V2 - Place the electrode at the fourth intercostal space, on the left sternal border
- V3 - Place the electrode midway between V2 and V4 on a line joining these 2 locations
- V4 - Place the electrode at the fifth intercostal space on the mid-clavicular line
- V5 - Place the electrode at the fifth intercostal space on the anterior axillary line
- V6 - Place the electrode at the fifth intercostal space on the mid-axillary line

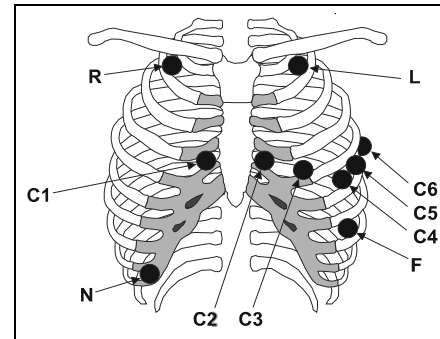

FIGURE 2-19 C-Lead Electrode Placement (IEC)

- C1 - Place the electrode at the fourth intercostal space, on the right sternal border
- C2 - Place the electrode at the fourth intercostal space, on the left sternal border
- C3 - Place the electrode midway between C2 and C4 on a line joining these 2 locations
- C4 - Place the electrode at the fifth intercostal space on the mid-clavicular line
- C5 - Place the electrode at the fifth intercostal space on the anterior axillary line
- C6 - Place the electrode at the fifth intercostal space on the mid-axillary line

Lead II Monitoring

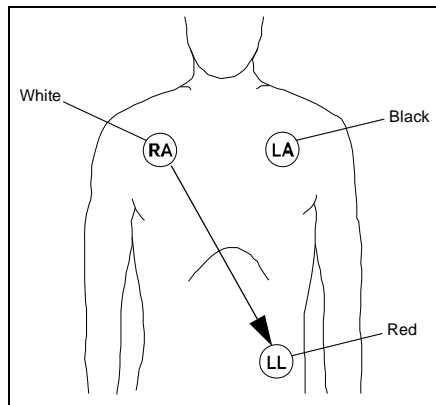

FIGURE 2-20 Lead II Monitoring (AHA)

- Place the RA (white) electrode under the patient's right clavicle, at the mid-clavicular line within the rib cage frame.
- Place the LA (black) electrode under the patient's left clavicle, at the mid-clavicular line within the rib cage frame.
- Place the LL (red) electrode on the patient's lower left abdomen within the rib cage frame.

Select ECG Lead II on the monitor. Lead II is the direct electrical line between the RA (white) electrode and the LL (red) electrode.

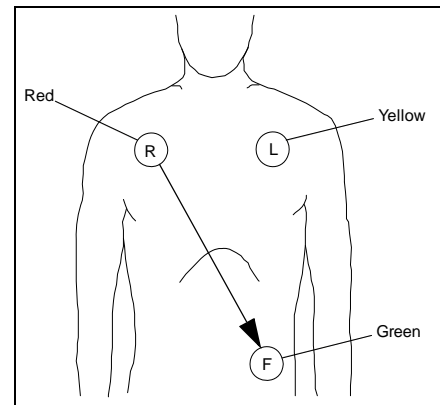

FIGURE 2-21 Lead II Monitoring (IEC)

- Place the R (red) electrode under the patient's right clavicle, at the mid-clavicular line within the rib cage frame.
- Place the L (yellow) electrode under the patient's left clavicle, at the mid-clavicular line within the rib cage frame.
- Place the F (green) electrode on the patient's lower left abdomen within the rib cage frame.

Select ECG Lead II on the monitor. Lead II is the direct electrical line between the R (red) electrode and the F (green) electrode.

Modified Chest Lead (MCL) Monitoring

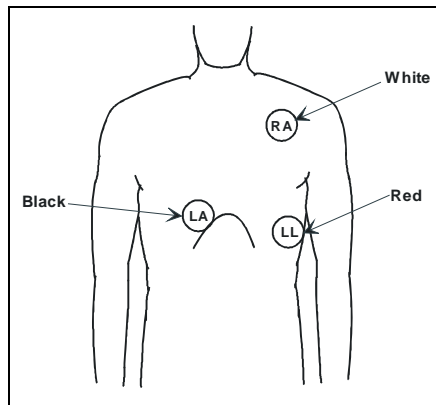

FIGURE 2-22 MCL Monitoring with a 3-wire Lead Set (AHA)

- Place the RA (white) electrode under the patient's left clavicle, at the mid-clavicular line within the rib cage frame.
- Place the LA (black) electrode on the right sternal border, at the fourth intercostal space within the rib cage frame.
- Place the LL (red) electrode on the patient's lower left abdomen within the rib cage frame.

Select ECG Lead I for MCL₁ monitoring. Lead I is the direct electrical line between the RA (white) electrode and the LA (black) electrode.

Select ECG Lead II for MCL₆ monitoring. Lead II is the direct electrical line between the RA (white) electrode and the LL (red) electrode.

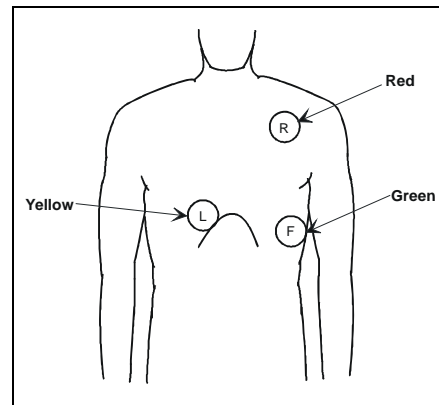

FIGURE 2-23 MCL Monitoring with a 3-wire Lead Set (IEC)

- Place the R (red) electrode under the patient's left clavicle, at the mid-clavicular line within the rib cage frame.
- Place the L (yellow) electrode on the right sternal border, at the fourth intercostal space within the rib cage frame.
- Place the F (green) electrode on the patient's lower left abdomen within the rib cage frame.

Select ECG Lead I for MCL₁ monitoring. Lead I is the direct electrical line between the R (red) electrode and the L (yellow) electrode.

Select ECG Lead II for MCL₆ monitoring. Lead II is the direct electrical line between the L (red) electrode and the F (green) electrode.

Monitoring a Pacemaker Patient

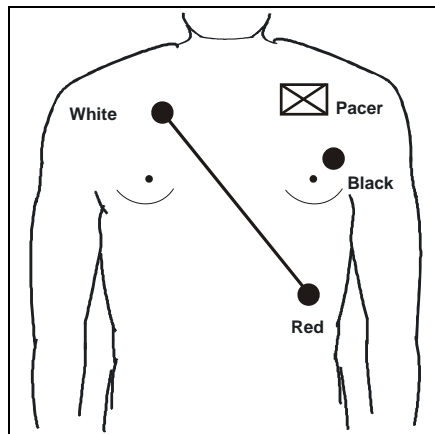

FIGURE 2-24 3-wire Lead Placement for a Pacemaker Patient (AHA)

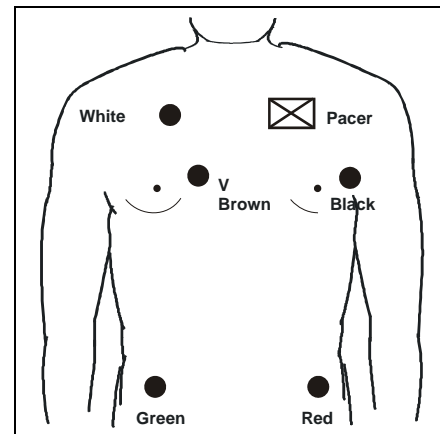

FIGURE 2-25 5-wire Lead Placement for a Pacemaker Patient (AHA)

A Pacemaker patient usually requires a different electrode patch placement configuration than a non-pacemaker patient.

Do not place an ECG electrode directly over the pacemaker generator. Place the electrode patches 3 – 5 inches away from the pacemaker generator area. For example, if the pacemaker generator is located in the right subclavian area, relocate the Right Arm (white) electrode closer in towards the center of the chest.

WARNING: Pacemaker patients' rate meters may continue to count the pacemaker rate during occurrences of cardiac arrest or some arrhythmias. Do not rely entirely upon rate meter alarms. Keep pacemaker patients under close surveillance. See Appendix section of this manual for disclosure of the pacemaker pulse rejection capability of this instrument.

CAUTION: Thoracic respiration measurement may interfere with some pacemakers. Refer to the pacemaker's manufacturer supplied manual.

Using a Transcutaneous Electrical Nerve Stimulator (TENS)

Since a TENS unit transmits electrical impulses, avoid placing ECG electrode patches near the TENS electrodes. ECG electrode patches may need to be repositioned and the ECG lead viewed may need to be adjusted until the optimum ECG tracing is obtained.

2.4.1.4 ECG Monitoring

NOTE: If an electro-surgical device is to be used on the patient, use the ESIS cable. Respiration from ECG is not available if the ESIS cable is used.

- Plug the patient cable firmly into the ECG connector on the **Trio**. An ECG waveform will begin to display in the ECG waveform tile and the heart rate will be displayed in the ECG parameter tile to the right (see FIGURE 2-26).
- Select the desired **ECG lead** by turning the Navigator™ Knob to highlight the lead label, located in the upper left corner of the ECG waveform tile. Press the knob to enable scrolling through available leads. Lead II is the default setting.
- Select the desired **ECG size** by turning the Navigator™ Knob to highlight the current waveform size, located in the upper left corner of the ECG waveform tile. Press the knob to enable scrolling through available sizes. The default setting is 2 cm/mV.

NOTE: Check ECG electrode sites every day for skin irritation. Replace electrodes as necessary.

2.4.1.5 ECG Lead, Size and Filter Settings



FIGURE 2-26 ECG settings on the Main Display

Use the Navigator™ Knob to select the following ECG settings (located in the upper left corner of the ECG waveform tile): ECG Lead, ECG Size, and ECG Filter.

1. ECG Lead

- The selectable leads when in 3 Lead mode are **I, II** and **III**
- The selectable leads when in 5 Lead mode are **I, II, III, aVR, aVL, aVF** and **V**

CAUTION: If a 3 Lead cable is used when a unit is set to 5 lead mode, no ECG signal will be obtained. If a 5 lead cable is used when the unit is set to 3 lead mode only Lead I, II and III are operable.

2. ECG Size

The selectable waveform sizes are: **0.25, 0.5, 1** and **2**.

- A waveform scale bar displays on the right side of each ECG channel. The height of the waveform bar is directly proportional to the waveform amplitude

3. ECG Filter

The available filter modes are: **MONITOR, EXTENDED** and **SURGERY**. These modes offer different frequency ranges over which the ECG signal is measured and displayed along with varying amounts of noise suppression.

• **MONITOR Mode**

MONITOR mode should be used for typical monitoring conditions. Its frequency range of 0.50 Hz to 40 Hz filters out most low frequency noise that can be generated by patient motion, muscle artifact, etc.

- **EXTENDED Mode**

EXTENDED mode should be used for diagnostic purposes. It has the widest frequency range and least noise suppression of the 3 modes. Its extended frequency range of 0.05 Hz to 100 Hz can provide a more accurate view of the waveform, but as a result can also be more susceptible to low frequency noise generated by patient motion, muscle artifact, etc.

- **SURGERY Mode**

SURGERY mode is recommended for use in OR situations or where the ability to measure a heart rate is more important than the fidelity of the waveform. It has the narrowest frequency range (1 Hz to 20 Hz) and hence the most noise suppression. It filters out more low frequency noise as well as the extreme amount of high frequency noise generated by an Electro-Surgical Device. However, the resultant waveform lacks detail. **SURGERY** mode is not recommended for Paced patients. The Pacer pulse can become sufficiently distorted so that it could be mistaken for a QRS complex, whereby a heart rate would continue to be counted even though the patient could be in cardiac arrest.

NOTE: During surgery or procedures which may introduce electrosurgical interference, the **SURGERY** mode should be used.

NOTE: There will be a delay in the heart rate and systole beep, reappearing after a change of lead or scale.

2.4.1.6 ECG Setup

ECG SETUP			
ALM	ON	PACER	OFF
ALM PRIORITY	1	CASCADE	ON
ALM PRINT	OFF	LEAD TYPE	5 LEADS
HR ALM HI	150	SWEEP	25.0
HR ALM LO	45	BEEP VOL	MED
SOURCE	ECG	RESTORE DEFAULTS	
Select to return to normal screen.			
NORMAL SCREEN			

FIGURE 2-27 ECG Setup Menu

Accessing the ECG Setup Menu

To access the **ECG SETUP** menu, select **ECG** from the **ECG** parameter tile using the Navigator™ Knob. Once in the **ECG SETUP** menu, use the Navigator Knob to adjust settings. To close the menu, select **NORMAL SCREEN** (from the menu or the Front Panel Keypad).

ECG Setup Menu Selections

ALM	<p>NOTE: In the French configuration, the HR (Heart Rate) alarm is always ON. It cannot be disabled by turning it OFF.</p> <p>Allows the user to turn the HR (Heart Rate) alarm ON or OFF. Choose ON to enable the alarm; choose OFF to disable the alarm. If the alarm is set to OFF, the alarm OFF symbol ☒ will display to the right of ECG on the screen. The HR alarm is activated when the heart rate is equal to or exceeds set high or low HR values.</p>
ALM PRIORITY	<p>Allows the user to select the priority of the ECG alarm. Choices are 1, 2 and 3. Priority 1 alarms are considered the most serious.</p>
ALM PRINT	<p>Enables or disables automatic printing during a HR alarm condition. Choose ON to enable printing upon HR alarm. Choose OFF to disable printing upon HR alarm.</p>
HR ALM HI	<p>Allows the user to set the upper limit of the HR alarm. (See "Heart Rate Alarm Limits" on page 2-27.)</p>
HR ALM LO	<p>Allows the user to set the lower limit of the HR alarm. (See "Heart Rate Alarm Limits" on page 2-27.)</p>
SOURCE	<p>Determines the source of heart rate. An audible tone is generated when a heart beat is detected from the selected source. The selections are ECG, SpO2 and AUTO.</p> <p>NOTE: When heart rate is being measured, a heart rate source label ("SOURCE:XXXX") is displayed in the ECG parameter tile. This label indicates from where the heart rate parameter is derived and is displayed in the same color as the ECG waveform.</p> <p>ECG: When ECG is selected as the heart rate source, the label HR (heart rate) is displayed in the ECG parameter tile. This label and its associated numeric value are displayed in the same color as the ECG waveform. The audible tone sounds with each R wave.</p> <p>SpO2: When SpO₂ is selected as the heart rate source, the label PR (pulse rate) is displayed in the ECG and SpO2 parameter tiles. This label and its associated numeric value are displayed in the same color as the SpO₂ numeric value. The audible tone sounds at the peak of each pulse wave.</p>

AUTO: When AUTO is selected as the heart rate source, the label and associated numeric value in the **ECG** parameter tile will be displayed based on the following hierarchy:

1. ECG will be the heart rate source as previously described if ECG is currently being monitored.
2. SpO₂ will be the heart rate source as previously described if SpO₂ is currently being monitored and ECG is not currently being monitored.
3. NIBP will be the heart rate source if NIBP is currently being monitored, ECG and SpO₂ are not currently being monitored, and the ECG ALM (alarm) is set to OFF. The label **HR** (heart rate) will be displayed in the **ECG** parameter tile. This label and its associated numeric value are displayed in the same color as the NIBP numeric/waveform data.

NOTE: Heart rate that is sourced through NIBP will time-out according to the NIBP "DISPLAY TIMEOUT" rules described on page 2-49.

PACER	To be used when a patient has a pacemaker. This should be used whether the pacemaker is active or is in standby mode. The ON selection will mark each detected pacemaker signal on the ECG waveform.
CASCADE	ECG cascade extends the ECG waveform into the second waveform tile. The selections are ON or OFF .
LEAD TYPE	Set the lead type on the monitor to match the type of ECG cable used. The selections are 3 Lead or 5 Lead ECG cables.
SWEEP	Adjusts the speed of the ECG waveform on the display. The selections are 12.5 , 25.0 and 50.0 mm/sec.
BEEP VOL	Beep volume is the volume of the audible tone for the Heart Rate. The selections are OFF , LOW , MED and HIGH .
RESTORE DEFAULTS	Allows the user to restore the ECG user default configuration.

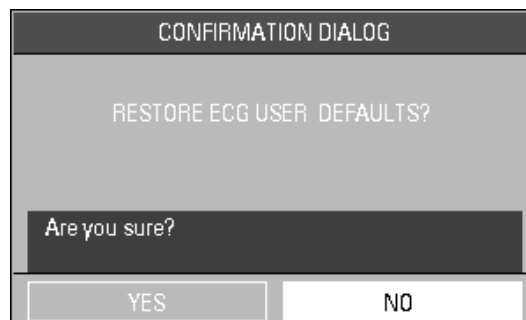

FIGURE 2-28 Confirmation Dialog Box

Heart Rate Alarm Limits*

PATIENT SIZE	HIGH ALARM (bpm)	LOW ALARM (bpm)
Adult (ADU)	60 – 250 [150]	30 – 120 [45]
Pediatric (PED)	100 – 300 [175]	30 – 150 [70]

* Factory default values shown in brackets.

Alarms occurring during the process of ECG measurement include two (2) types: physiological alarms and technical alarms. Physiological alarms occur when the patient's heart rate value is equal to or exceeds set alarm limits. Technical alarms are any ECG-related alarms, which are not physiological, such as functional failures.

2.4.1.7 ECG Troubleshooting

MESSAGE/ PROBLEM	REASON	SOLUTION
ECG LEAD OFF, or ECG XX LEAD OFF	ECG electrodes are detached from the skin, ECG cables are disconnected from the monitor or ECG lead wires are disconnected from ECG cable	Check all patient connections. Prep chest, change electrodes, check and replace leads.
ECG INIT ERR	ECG module failure	Notify hospital technician or Customer Support
ECG COMM STOP	Intermittent communication failure	Notify hospital technician or Customer Support
ECG COMM ERR	Intermittent communication failure	Notify hospital technician or Customer Support
HR ALM LMT ERR	Functional failure	Notify hospital technician or Customer Support
ECG NOISE	ECG signal interference	Apply fresh, moist electrodes. Replace cable or lead wires as necessary. Eliminate 60 Hz interference. Use ECG cable with internal filter block.
Noisy ECG trace	Loose or dry electrodes Defective cable or lead wires Patient cable or leads are routed too close to other electrical devices.	Apply fresh, moist electrodes. Replace cable or lead wires as necessary Eliminate 60 Hz interference. Use ECG cable with internal filter block.
Excessive Electro-surgical Interference	Inadequate skin preparation prior to application of electrode	Repeat skin preparation and electrode placement procedures. Apply fresh, moist electrodes.
Intermittent Signal	Connections not tight and/or properly secured Electrodes dry or loose Cable or leadwires damaged	Ensure proper connection. (cable to monitor, cable to lead, lead to electrode). Repeat skin preparation and apply fresh, moist electrodes. Check with a continuity tester.

MESSAGE/ PROBLEM	REASON	SOLUTION
Excessive alarms: Heart rate, lead fault	Electrodes dry	Repeat skin preparation and apply fresh, moist electrodes.
	Alarm limits set too close to patient's normal heart rate	Readjust alarm limits.
	R-wave wrong size	Readjust the waveform size or move ECG electrodes to optimize R-wave.
	Excessive patient movement or muscle tremor	Reposition electrodes and secure with tape if necessary.
Low Amplitude ECG Signal	Gain set too low	Readjust the ECG wave gain as required. Refer to "ECG Lead, Size and Filter Settings" on page 2-23 for instructions on adjusting the wave gain setting.
	Electrodes dry/old	Apply fresh, moist electrodes.
	Skin improperly prepped	Abrade the skin and repeat skin preparation.
	This could be the patient's normal QRS complex.	Verify with a 12-lead electrocardiogram.
	Electrode positioned over a bone or muscle mass	Reposition electrodes.
No ECG waveform	Size not set properly	Readjust the ECG wave gain as required. Refer to "ECG Lead, Size and Filter Settings" on page 2-23 for instructions on adjusting the wave gain setting.
	Lead wires and/or patient cable not fully inserted into proper receptacle	Check cables for proper connection
	Cables or lead wires damaged	Check with a continuity tester.
Base Line Wander	Patient moving excessively.	Secure lead wires and cable to patient.
	Patient respiration variance.	Reposition electrodes
	Electrodes dry or loose	Repeat skin preparation and apply fresh, moist electrodes.

2.4.2 Respiration Monitoring

The **Trio** utilizes thoracic impedance to measure respiration. This is accomplished by passing a small electrical signal across the RA and LL (R and F) ECG limb leads. This signal changes as the patient's chest wall rises and falls during the breath cycle. The change of impedance between the two (2) electrodes, (due to the thoracic movement), produces a respiratory waveform on the screen.

2.4.2.1 Setting Up Respiration Measurement

For Respiration monitoring, it is not necessary to use additional electrodes. However, the proper placement of electrodes is important. Depending upon the medical condition of the patient it may be necessary to reposition the ECG electrodes to optimize respiratory signal.

Prep the patient's skin for electrode placement as described in the ECG section of this manual (See section 2.4.1).

2.4.2.2 Respiration Setup Menu

Accessing the Respiration Menu

To access the **RESP SETUP** menu, select **RESP** from the **RESP** parameter tile using the Navigator™ Knob. The **RESP SETUP** menu (FIGURE 2-29) is displayed. Use the Navigator Knob to adjust settings. To close the menu, select **NORMAL SCREEN** (from the menu or the Front Panel Keypad).

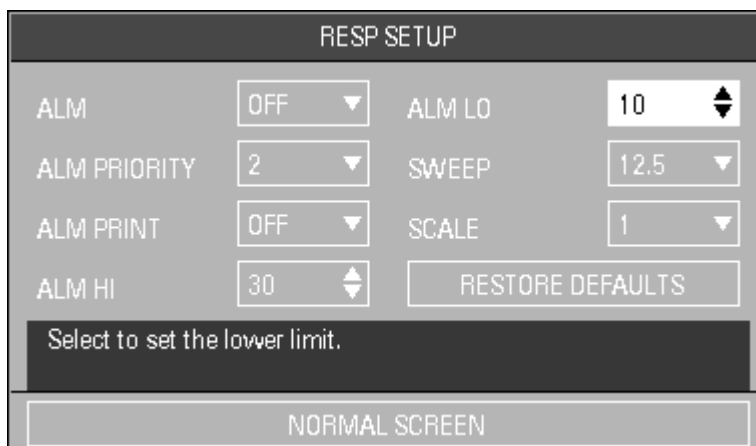



FIGURE 2-29 Respiration Setup Menu

Respiration Setup Menu Selections

ALM Allows the user to turn the **RESP** (Respiration) alarm **ON** or **OFF**. Choose **ON** to enable the alarm; choose **OFF** to disable the alarm. If the alarm is set to **OFF**, the alarm **OFF** symbol  will display to the right of **RESP** on the screen. The **RESP** alarm is activated when the respiration rate exceeds set high or low **RESP** values.

- ALM PRIORITY** Allows the user to select the priority of the **RESP** alarm. Choices are **1**, **2** and **3**. Priority 1 alarms are considered the most serious.
- ALM PRINT** Enables or disables automatic printing during a **RESP** alarm condition. Choose **ON** to enable printing upon **RESP** alarm. Choose **OFF** to disable printing upon **RESP** alarm.
- ALM HI** Allows the user to set the upper limit of the **RESP** alarm. (See "Respiration Rate Alarm Limits" on page 2-30.)
- ALM LO** Allows the user to set the lower limit of the **RESP** alarm. (See "Respiration Rate Alarm Limits" on page 2-30.)
- SWEEP** Adjusts the speed of the **RESP** waveform on the display. The selections are **6.25**, **12.5** and **25.0** mm/sec.
- SCALE** Changes the size of the **RESP** waveform. The selections are **0.25**, **0.5**, **1**, **2**, **3**, **4** and **5**.
- RESTORE DEFAULTS** Allows the user to restore the **RESP** user default configuration.

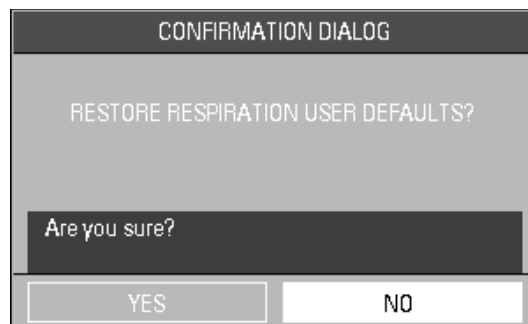

FIGURE 2-30 Confirmation Dialog Box

Respiration Rate Alarm Limits*

PATIENT SIZE	HIGH ALARM (rpm)	LOW ALARM (rpm)
Adult (ADU)	10 – 100 [30]	6 – 30 [6]
Pediatric (PED)	15 – 150 [30]	6 – 40 [6]

* *Factory default values shown in brackets.*

Alarms occurring during the process of Respiration measurement include two (2) types: physiological alarms and technical alarms. Physiological alarms occur when the patient's respiration rate is equal to or exceeds set alarm limits. Technical alarms are any Respiratory-related alarms, which are not physiological, such as functional failures.

2.4.2.3 Respiration Troubleshooting

MESSAGE/ PROBLEM	REASON	SOLUTION
RESP ALM LMT ERR	Functional failure	Notify hospital technician or Customer Support
RR EXCEED	Respiration value exceeds the measurement range	Check patient, notify physician
Respiration Waveform too Large	Scales set inappropriately	Change lead selection Change Respiration scale
Respiration Waveform too Small	Patient breathing shallow or turned on side Scale set inappropriately	Change lead selection Change Respiration scale
ARTIFACT	Respiration value equals the heart rate Shallow breathing Cessation of breathing	Check patient, notify physician Change Respiration scale, Adjust leads Check patient, notify physician
No Respiration Waveform	Cable not connected ESIS cable in use	Check cable connections Use non-ESIS cable only for Respiration detection
No Respiration rate displayed	Cable not connected ESIS cable in use Cardiovascular Artifact Detected	Check cable Use non-ESIS cable only for respiration detection Check patient, notify physician Change Respiration scale Adjust leads

2.4.3 SpO₂ Monitoring

Each of the following terms are associated with blood oxygenation: oxygen saturation, pulse oximetry, SpO₂ and plethysmography.

Oxygen saturation in capillary blood is measured by a method called pulse oximetry. Pulse oximetry is a continuous and non-invasive measurement of oxyhemoglobin saturation (the amount of oxygen attached to the hemoglobin in red blood cells). SpO₂ is the estimation of arterial oxygen saturation. This term is used interchangeably with SaO₂. This value is displayed in the SpO₂ parameter tile (FIGURE 2-31) along with the Pulse Rate and the Pulse Amplitude Indicator. The indicator provides a graphic depiction of the relative pulse volume.

When the **Trio** is equipped with Nellcor® OxiMax® SpO₂, the SpO₂ parameter tile displays a SatSeconds™ Indicator when the SatSeconds function is enabled as described in section 2.4.3.2.

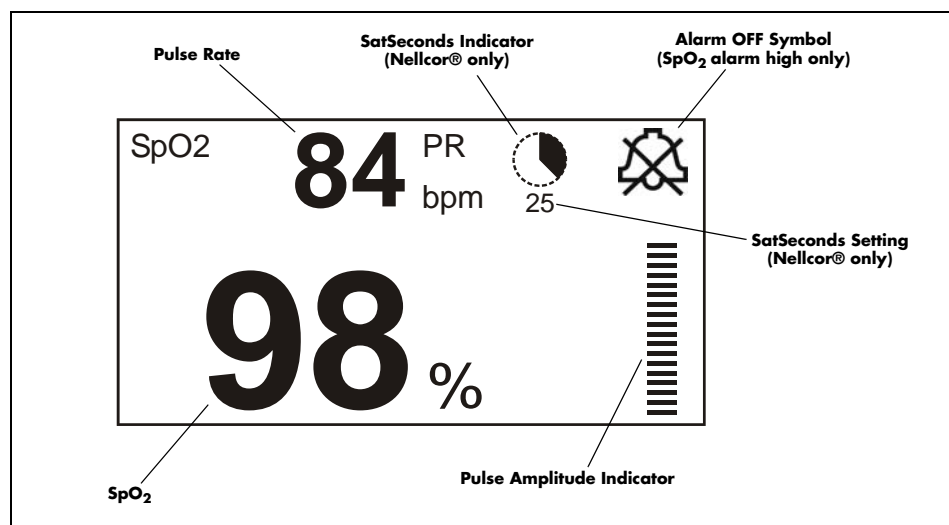

FIGURE 2-31 SpO₂ Parameter Tile

The corresponding plethysmogram is a waveform representation of the arterial oxygenation and pulse detection. The pleth waveform is automatically scaled and no adjustment can be made to its size. The SpO₂ results are updated once every second.

Traditional pulse oximetry determines SpO₂ by passing red and infrared light into a capillary bed and measuring changes in light absorption during the pulsatile cycle. Red and infrared light-emitting diodes (LEDs) in oximetry sensors serve as the light sources, a photodiode serves as the photo detector.

Traditional pulse oximetry assumes that all pulsations in the light absorbance signal are caused by oscillations in the arterial blood volume. This also assumes that the blood flow in the region of the sensor passes entirely through the capillary bed rather than through any arterio-venous shunts.

Performance Considerations

To ensure optimal SpO₂ measurement, use an appropriate sensor, apply it as directed, and observe all warnings and cautions. Sensors are designed for specific sites on patients with designated weight ranges. To select the appropriate sensor, consider the patient's weight, level of activity, adequacy of perfusion, available sensor sites and the sterility requirement.

If excessive ambient light is present, cover the sensor site with opaque material. Failure to do so may cause inaccurate measurements. Light sources that can affect performance include surgical lights (especially those with a xenon light source), bilirubin lamps, fluorescent lights, infrared heating lamps, and direct sunlight.

If a reading is unobtainable or inaccurate, consider the following:

- If the patient is poorly perfused, apply the sensor to a different finger or toe.
- Ensure that the sensor is properly aligned and securely applied.
- Use a new sensor.
- Move the sensor to a less active site.
- Use a type of sensor that tolerates some patient motion.
- Ensure that the sensor and site are clean/non-greasy. Remove nail polish and fungus.

Calibration

The oximetry sub-system incorporates automatic calibration mechanisms. No other calibration is required.

Auto Scaling

The pleth waveform is automatically scaled and is not proportional to the patient's pulse volume. There is no adjustment that can be made to the pleth waveform.

CAUTION: Prolonged and continuous monitoring may increase the risk of skin erosion and pressure necrosis at the site of the sensor. Check the SpO₂ sensor site frequently to ensure proper positioning, alignment and skin integrity at least every eight (8) hours; with the Adult and Pediatric re-usable finger sensor, check every four (4) hours; for patients of poor perfusion or with skin sensitive to light, check every 2 - 3 hours; more frequent examinations may be required for different patients. Change the sensor site if signs of circulatory compromise occur.

-
- CAUTION:** Do not place the SpO2 sensor on an extremity with an invasive catheter or blood pressure cuff in place.
- CAUTION:** Tissue damage or inaccurate measurement may be caused by incorrect sensor application or use, such as wrapping too tightly, applying supplemental tape, failing to inspect the sensor site periodically or failing to position appropriately. Carefully read the sensor directions and all precautionary information before use.
- CAUTION:** Inaccurate SpO2 measurements may be caused by:
- incorrect sensor application or use
 - significant levels of dysfunctional hemoglobins, (e.g., carboxyhemoglobin or methemoglobin)
 - intra-vascular dyes such as indocyanine green or methylene blue
 - exposure to excessive illumination such as surgical lamps (especially ones with a xenon light source), bilirubin lamps, fluorescent lights, infrared heating lamps, or excessive ambient light. In such cases, cover the sensor site with opaque material.
 - excessive patient movement
 - venous pulsations
 - electro-surgical interference
 - placement of a sensor on an extremity that has a blood pressure cuff, arterial catheter or intra-vascular line.
 - nail polish or fungus
- CAUTION:** In certain situations in which perfusion and signal strength are low, such as in patients with thick or pigmented skin, inaccurately low SpO2 readings will result. Verification of oxygenation should be made, especially in preterm infants and patients with chronic lung disease, before instituting any therapy or intervention.
- CAUTION:** Many patients suffer from poor peripheral perfusion due to hypothermia, hypovolemia, severe vasoconstriction, reduced cardiac output, etc. These symptoms may cause a loss in vital sign readings.
- CAUTION:** If the sensor or patient cable are damaged in any way, discontinue use immediately. To prevent damage, do not soak or immerse the sensor in any liquid solution. Do not attempt to sterilize.
- CAUTION:** Excessive ambient light may cause inaccurate measurements. In such cases, cover the sensor site with opaque material.

2.4.3.1 Masimo SET[®] SpO₂

The Masimo pulse oximeter determines SpO₂ in the traditional manner of passing red and infrared light into a capillary bed and measuring changes in light absorption during the pulsatile cycle. It assumes that arterio-venous shunting is highly variable and that fluctuating absorbance by venous blood is the major component of noise during the pulse. The Masimo pulse oximeter calculates the ratio of the arterial signals without the noise.

Masimo SET provides a family of sensors suitable for a wide variety of clinical settings and patient sizes. All sensors are:

- Indicated for continuous non-invasive monitoring of arterial oxygen saturation (SpO₂) and Pulse Rate
- Non-sterile
- Usable during patient movement

The LNOP[®]•DCI Adult Reusable Finger Sensor can be used for "spot check" applications if needed. Adhesive-type sensors are also available. Refer to "Accessories" on page 5-1 for approved sensors. All sensors are intended for "single-patient use only" unless indicated as "reusable".

CAUTION: When equipped with Masimo SpO₂, use only Masimo oxygen sensors and cables. Use of other oxygen sensors may cause improper oximeter performance.

NOTE: Refer to instructions included with each SpO₂ sensor and cable for proper placement and use.

1. Select an SpO₂ sensor that is appropriate for the size of the patient.
2. Attach the connector of the SpO₂ sensor to the SpO₂ extension cable.
3. Attach the SpO₂ sensor to the patient's finger (or other appropriate site).
4. Orient the connector on the end of the SpO₂ extension cable so that the Masimo SET logo is facing upward. Plug the connector into the SpO₂ receptacle on the right side panel of the **Trio**. The SpO₂ measurement will display when the **Trio** detects that the sensor is connected to the patient. A plethysmogram will be displayed to the left of the SpO₂ parameter tile (if SpO₂ is selected in the **TRACE SETUP** menu).

NOTE: To disconnect the cable from the Trio, squeeze the tabs on the sides of the connector and then pull it straight out.

CAUTION: Prolonged and continuous monitoring may increase the risk of skin erosion and pressure necrosis at the site of the sensor. Check the SpO₂ sensor site frequently to ensure proper positioning, alignment and skin integrity at least every eight (8) hours; with the Adult and Pediatric re-usable finger sensor, check every four (4) hours; for patients of poor perfusion or with skin sensitive to light, check every 2 - 3 hours; more frequent examinations may be required for different patients. Change the sensor site if signs of circulatory compromise occur.

2.4.3.1.1 Masimo SET[®] SpO₂ Setup Menu

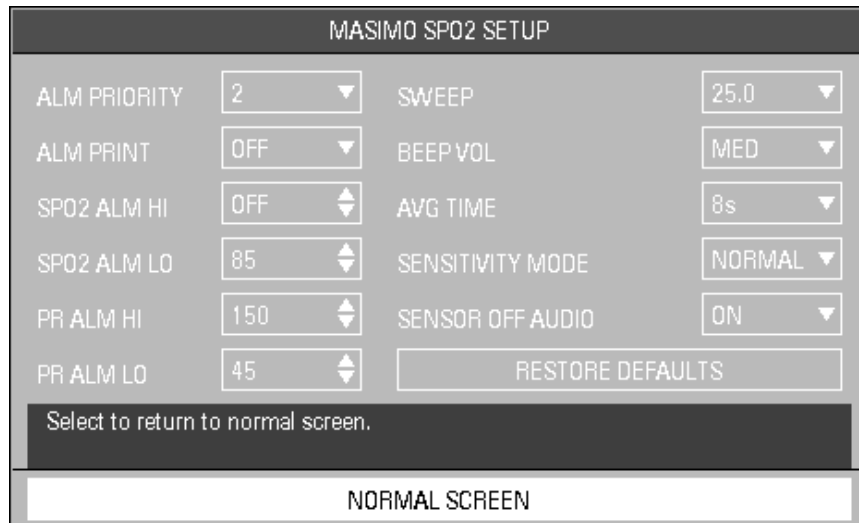

FIGURE 2-32 Masimo SET SpO₂ Setup Menu

Accessing the Masimo SET SpO₂ Setup Menu

To access the **MASIMO SPO2 SETUP** menu, select **SpO₂** from the **SpO₂** parameter tile using the Navigator™ Knob. Once in the **MASIMO SPO2 SETUP** menu, use the Navigator Knob to adjust settings. To close the menu, select **NORMAL SCREEN** (from the menu or the Front Panel Keypad).

Masimo SET SpO₂ Setup Menu Selections

- ALM PRIORITY** Enables the user to select the priority of the SpO₂ alarm. Choices are: **1**, **2** and **3**. Priority 1 alarms are considered the most serious.
- ALM PRINT** Enables or disables automatic printing during an SpO₂ alarm condition. Choose **ON** to enable printing upon SpO₂ alarm. Choose **OFF** to disable printing upon SpO₂ alarm.
- SPO2 ALM HI** Allows the user to set the upper limit of the SpO₂ alarm. (See “Masimo SET SpO₂ Alarm Limits” on page 2-38.)
- SPO2 ALM LO** Allows the user to set the lower limit of the SpO₂ alarm. (See “Masimo SET SpO₂ Alarm Limits” on page 2-38.)
- PR ALM HI** Allows the user to set the upper limit of the Pulse Rate alarm. (See “Masimo SET SpO₂ Alarm Limits” on page 2-38.)
- PR ALM LO** Allows the user to set the lower limit of the Pulse Rate alarm. (See “Masimo SET SpO₂ Alarm Limits” on page 2-38.)
- SWEEP** Adjusts the speed of the SpO₂ waveform on the display. The selections are **12.5** and **25.0** mm/sec.

BEEP VOL Beep volume is the volume of the audible pulse rate tone when SpO₂ is selected as the HR Source. The selections are **OFF**, **LOW**, **MED** and **HIGH**.

AVG TIME Averaging time is the length of time during which the SpO₂ value is calculated. The selections are **2-4**, **4-6**, **8**, **10**, **12**, **14**, and **16** seconds. When **2-4** or **4-6** are selected, the FastSAT mode is enabled. In this mode, shorter averaging times are achieved under low noise conditions. Under high noise conditions, a longer averaging time is utilized.

SENSITIVITY MODE Sensitivity mode should be selected based on signal quality and patient motion. In most cases where there is some level of patient motion present, the normal sensitivity setting is appropriate. If patient motion is limited, the high sensitivity setting can be used. High sensitivity should be used when it is difficult to get a reading on a patient with low perfusion. This mode will compromise the probe off detection. Selections are **Normal** and **High**.

SENSOR OFF AUDIO Controls the onset of the audio beep alarm for the "SpO₂ Sensor OFF" condition. The selections are **ON** and **OFF**.

If ON is selected, then the audio beep alarm will sound when an "SpO₂ Sensor OFF" condition occurs. If OFF is selected, then the audio beep alarm will not sound when an "SpO₂ Sensor OFF" condition occurs.

RESTORE DEFAULTS Allows the user to restore the SpO₂ user default configuration.

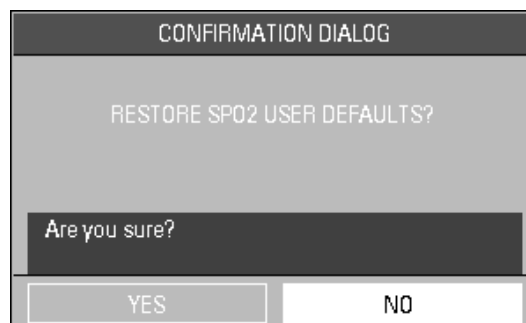

FIGURE 2-33 Confirmation Dialog Box

Masimo SET SpO₂ Alarm Limits*

PATIENT SIZE	SpO ₂ HIGH ALARM (%)	SpO ₂ LOW ALARM (%)	PR HIGH ALARM (bpm)	PR LOW ALARM (bpm)
Adult (ADU)	80 – 100 [OFF]	50 – 99 [85]	60 – 240 [150]	25 – 120 [45]
Pediatric (PED)	80 – 100 [OFF]	50 – 99 [85]	100 – 240 [175]	25 – 150 [70]

* Factory default values shown in brackets.

NOTE: If the SpO₂ alarm high is set to OFF, the alarm OFF symbol  will display in the SpO₂ parameter tile.

Alarms occurring during the process of SpO₂ measurement include two (2) types: physiological alarms and technical alarms. Physiological alarms occur when the patient's pulse rate or oxygen saturation level is equal to or exceeds set alarm limits. Technical alarms are any SpO₂-related alarms, which are not physiological, such as functional failures.

2.4.3.1.2 Masimo SET[®] SpO₂ Troubleshooting

MESSAGE	REASON	ACTION
SpO ₂ : Sensor Off	SpO ₂ sensor may be disconnected from the patient	Place the sensor on the patient.
SpO ₂ : No Sensor	SpO ₂ sensor may be disconnected from the monitor or the extension cable	Plug the sensor into the monitor or the extension cable.
SpO ₂ : Interference	Noise detected on the pulse signal prevents pulse discrimination	Decrease patient motion. Check sensor.
SpO ₂ : Pulse Search	Hardware settings are being adjusted in order to discriminate a pulse waveform	Wait several seconds for saturation value to be displayed. If it does not display, do one of the following: <ul style="list-style-type: none"> Change to site where pulse is stronger if patient is vasoconstricted. Change or readjust sensor if loose.
SpO ₂ : Low Perfusion	Patient perfusion is low	Check patient connection and patient status
SpO ₂ : Too Much Light	There is too much ambient room light for the sensor to function properly	Minimize the room light around the patient. Check sensor.
SpO ₂ : Unrecognized Sensor	The sensor is not recognized by the monitor	Replace the sensor with a recommended authorized sensor
SpO ₂ : Communication Error	The monitor and the SpO ₂ modules are not communicating properly	Power the unit OFF/ON. If problem persists, notify hospital technician or Customer Support.
SpO ₂ : Board Fault	Masimo SET board failed to operate properly	Notify hospital technician or Customer Support
SpO ₂ : Sensor Fault	Defective Sensor	Replace sensor

2.4.3.2 Nellcor® SpO₂

Nellcor provides a family of sensors suitable for a wide variety of clinical settings and patients. Specific sensors have been developed for a variety of patient sizes.

Nellcor's SatSeconds™ Alarm Management feature in their OxiMax® SpO₂ sensor offers an effective means of managing nuisance alarms without sacrificing patient safety. Nuisance alarms are often triggered by minor and brief desaturation events that are clinically insignificant and are often managed by widening alarm limits, turning OFF the alarm or monitor, or simply ignoring the alarm. The SatSeconds feature distinguishes clinically insignificant events from events of consequence.

When an SpO₂ measurement exceeds the alarm limit, the SatSeconds indicator begins to fill clockwise. The difference between the measurement and the limit multiplied by the time the measurement remains outside the limit determines if or when the SatSeconds alarm occurs. For example:

The low SpO₂ alarm is set at 90% and the SatSeconds "clock" is set to 25.

- If the measurement is 85% for 4 seconds (i.e., 5% below the limit for 4 seconds), then 5% X 4 seconds = 20 SatSeconds. This is less than the 25 SatSeconds setting, therefore no alarm will occur.
- If the measurement is 85% for 7 seconds (i.e., 5% below the limit for 7 seconds), then 5% X 7 seconds = 35 SatSeconds. This is greater than the 25 SatSeconds setting, therefore an alarm occurs at 5 seconds because 5% X 5 seconds = 25 SatSeconds. The alarm continues for another 2 seconds.

When the SpO₂ measurement returns to within the alarm limits, the SatSeconds indicator clears (empties) counter-clockwise in the same amount of time that it took for the SatSeconds alarm condition to be acquired. The "clear" time is equivalent to the acquire time.

Nellcor's SatSeconds™ Alarm Management technology also features a safety precaution. When three (3) SpO₂ alarm violations occur within 60 seconds, a priority 2 alarm will trigger even if the SatSeconds limit has not been reached.

CAUTION: When equipped with Nellcor SpO₂, use only Nellcor oxygen sensors and cables. Use of other oxygen sensors may cause improper oximeter performance.

NOTE: Refer to instructions included with each SpO₂ sensor and cable for proper placement and use. If the sensor LED does not illuminate within 3 seconds after being connected, then the sensor is probably defective and should be replaced.

1. Select an SpO₂ sensor that is appropriate for the size of the patient.
2. Attach the connector of the SpO₂ sensor to the SpO₂ extension cable.
3. Attach the SpO₂ sensor to the patient's finger (or other appropriate site).
4. Plug the connector on the end of the SpO₂ extension cable into the SpO₂ receptacle on the right side panel of the **Trio**. The SpO₂ measurement will display when the **Trio** detects that the sensor is connected to the patient. A plethysmogram will be displayed to the left of the SpO₂ parameter tile (if SpO₂ is selected in the **TRACE SETUP** menu).

NOTE: To disconnect the cable from the **Trio**, squeeze the tabs on the sides of the connector and then pull it straight out.

CAUTION: Prolonged and continuous monitoring may increase the risk of skin erosion and pressure necrosis at the site of the sensor. Check the SpO₂ sensor site frequently to ensure proper positioning, alignment and skin integrity at least every eight (8) hours; with the Adult and Pediatric re-usable finger sensor, check every four (4) hours; for patients of poor perfusion or with skin sensitive to light, check every 2 - 3 hours; more frequent examinations may be required for different patients. Change the sensor site if signs of circulatory compromise occur.

2.4.3.2.1 Nellcor[®] SpO₂ Setup Menu

NELLCOR SPO2 SETUP			
ALM PRIORITY	2	SWEEP	25.0
ALM PRINT	OFF	BEEP VOL	MED
SPO2 ALM HI	OFF	SENSOR OFF AUDIO	ON
SPO2 ALM LO	85	SAT SECONDS	OFF
PR ALM HI	150	RESTORE DEFAULTS	
PR ALM LO	45		
Select to return to normal screen.			
NORMAL SCREEN			

FIGURE 2-34 Nellcor SpO₂ Setup Menu

Accessing the Nellcor SpO₂ Setup Menu

To access the **NELLCOR SPO2 SETUP** menu, select **SpO₂** from the **SpO₂** parameter tile using the Navigator™ Knob. Once in the **NELLCOR SPO2 SETUP** menu, use the Navigator Knob to adjust settings. To close the menu, select **NORMAL SCREEN** (from the menu or the Front Panel Keypad).

Nellcor SpO₂ Setup Menu Selections

- ALM PRIORITY** Enables the user to select the priority of the SpO₂ alarm. Choices are: **1**, **2** and **3**. Priority 1 alarms are considered the most serious.
- ALM PRINT** Enables or disables automatic printing during an SpO₂ alarm condition. Choose **ON** to enable printing upon SpO₂ alarm. Choose **OFF** to disable printing upon SpO₂ alarm.
- SPO2 ALM HI** Allows the user to set the upper limit of the SpO₂ alarm. (See "Nellcor SpO₂ Alarm Limits" on page 2-42.)
- SPO2 ALM LO** Allows the user to set the lower limit of the SpO₂ alarm. (See "Nellcor SpO₂ Alarm Limits" on page 2-42.)

PR ALM HI	Allows the user to set the upper limit of the Pulse Rate alarm. (See "Nellcor SpO ₂ Alarm Limits" on page 2-42.)
PR ALM LO	Allows the user to set the lower limit of the Pulse Rate alarm. (See "Nellcor SpO ₂ Alarm Limits" on page 2-42.)
SWEEP	Adjusts the speed of the SpO ₂ waveform on the display. The selections are 12.5 and 25.0 mm/sec.
BEEP VOL	Beep volume is the volume of the audible pulse rate tone when SpO ₂ is selected as the HR Source. The selections are OFF , LOW , MED and HIGH .
SENSOR OFF AUDIO	Controls the onset of the audio beep alarm for the "SpO ₂ Sensor OFF" condition. The selections are ON and OFF . If ON is selected, then the audio beep alarm will sound when an "SpO ₂ Sensor OFF" condition occurs. If OFF is selected, then the audio beep alarm will not sound when an "SpO ₂ Sensor OFF" condition occurs.
SAT SECONDS	Controls pulse oximetry nuisance alarms (see section 2.4.3.2 for details on SatSeconds™ features). The selections are OFF , 10 , 25 , 50 or 100 . When SatSeconds is enabled, the SpO ₂ Low and High Alarm functions are automatically disabled. As a safety precaution, if three (3) SpO ₂ alarm violations occur within 60 seconds, a priority 2 alarm will trigger even if the SatSeconds limit has not been reached.
RESTORE DEFAULTS	Allows the user to restore the SpO ₂ user default configuration.

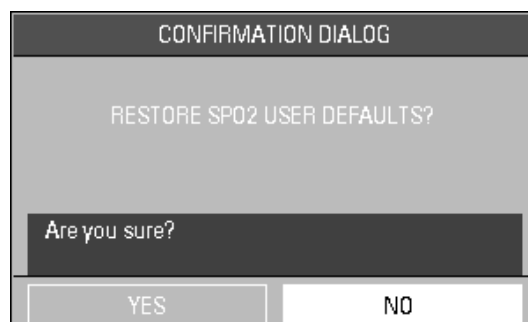

FIGURE 2-35 Confirmation Dialog Box

Nellcor SpO₂ Alarm Limits*

PATIENT SIZE	SpO ₂ HIGH ALARM (%)	SpO ₂ LOW ALARM (%)	PR HIGH ALARM (bpm)	PR LOW ALARM (bpm)
Adult (ADU)	80 – 100 [OFF]	50 – 99 [85]	60 – 250 [150]	20 – 120 [45]
Pediatric (PED)	80 – 100 [OFF]	50 – 99 [85]	100 – 250 [175]	20 – 150 [70]

* Factory default values shown in brackets.

NOTE: If the SpO₂ alarm high is set to OFF, the alarm OFF symbol  will display in the SpO₂ parameter tile.

Alarms occurring during the process of SpO₂ measurement include two (2) types: physiological alarms and technical alarms. Physiological alarms occur when the patient's pulse rate or oxygen saturation level is equal to or exceeds set alarm limits. Technical alarms are any SpO₂-related alarms, which are not physiological, such as functional failures.

2.4.3.2.2 Nellcor SpO₂ Troubleshooting

MESSAGE	REASON	ACTION
SPO2 SENSOR OFF	SpO ₂ sensor may be disconnected from the patient	Place the sensor on the patient.
SPO2 NO SENSOR	SpO ₂ sensor may be disconnected from the monitor or the extension cable	Plug the sensor into the monitor or the extension cable.
SPO2 PULSE SEARCH	Hardware settings are being adjusted in order to discriminate a pulse waveform	Wait several seconds for saturation value to be displayed. If it does not display, do one of the following: <ul style="list-style-type: none"> Change to site where pulse is stronger if patient is vasoconstricted. Change or readjust sensor if loose.
SPO2 CHECK SENSOR	SpO ₂ sensor may be defective, incompatible, or improperly connected.	Reconnect the same sensor or replace the sensor.
SPO2 COMMUNICATION ERROR	The monitor and the SpO ₂ modules are not communicating properly	Power the unit OFF/ON. If problem persists, notify hospital technician or Customer Support.
SPO2 BOARD FAULT	SpO ₂ board is not producing measurement values.	Power the unit OFF/ON. If problem persists, notify hospital technician or Customer Support.
SPO2 MOTION	Motion is detected.	Decrease patient motion.
SPO2 INIT ERR	SpO ₂ module failure.	Notify hospital technician or Customer Support
SPO2 COMM STOP	SpO ₂ module failure or communication error.	Notify hospital technician or Customer Support
SPO2 ALM LMT ERR	Functional failure.	Notify hospital technician or Customer Support
PR ALM LMT ERR	Functional failure.	Notify hospital technician or Customer Support

MESSAGE	REASON	ACTION
SPO2 EXCEED	SpO2 value exceeds the measurement range.	Check patient, notify physician
PR EXCEED	PR value exceeds the measurement range.	Check patient, notify physician

2.4.4 NIBP Monitoring

The **Trio** utilizes the oscillometric method of measuring Non-Invasive Blood Pressure (NIBP). The measurement includes Systolic (SYS), Diastolic (DIA) and Mean Arterial Pressures (MAP).

Two (2) frequency modes of obtaining measurements are available: **MANUAL** and **INTERVAL**. Each mode will display the Systolic (SYS), Diastolic (DIA) and Mean Arterial Pressure (MAP) values in the NIBP tile.

MANUAL MODE Each time a measurement is desired, press the **NIBP** key on the **Trio** keypad to initiate a measurement. Press the **NIBP** key a second time to stop a measurement already in progress.

INTERVAL MODE Measurements are taken automatically at selected time intervals. The selections are: **CONT** (continuous), **1min**, **2min**, **3min**, **4min**, **5min**, **10min**, **15min**, **30min**, **1HR**, **2HRS**, **4HRS** or **OFF**. The **NIBP** key on the **Trio** keypad must be pressed to initiate the first measurement of the interval measurement cycle. If the patient is discharged from the monitor while in interval mode, the interval setting will revert to the User Default and the next measurement will be delayed until the **NIBP** key is pressed. During the delay period, the interval setting will remain displayed in the NIBP numeric tile and the Elapsed Time (ET) will display as "0min".

CAUTION: Use only approved blood pressure cuffs and hoses with the Trio.

CAUTION: A patient's skin is sometimes fragile (i.e. on pediatric and geriatric patients or due to physiological conditions). In these cases, a longer time duration between measurements should be considered to decrease the number of cuff inflations over a period of time. In extreme cases, a thin layer of soft roll or cotton padding may be applied to the limb in order to cushion the skin when the cuff is inflated. This measure may affect NIBP performance and should be used with caution.

CAUTION: Please consult a physician for interpretation of blood pressure measurements.

CAUTION: A blood pressure measurement can be affected by the position of the patient, and his/her physiological condition as well as other factors, such as patient movement.

CAUTION: Any condition which may affect the regularity and strength of arterial pressures (such as patient movement, cardiac arrhythmias, restriction of hose, etc.), will affect the accuracy and ability to measure the NIBP.

CAUTION: Observe caution on all patients (Pediatrics and Adults) when NIBP is set to the Continuous mode and the 1 minute Interval. When the NIBP "Continuous" interval is chosen, the Trio will continually take back to back blood pressure readings. As a safety precaution, a limit is placed on the Continuous mode to revert to an interval of every 5 minutes after 5 minutes of continuous readings.

The initial default cuff inflation pressure is dependent on the patient size setting as follows:

PATIENT SIZE SETTING	DEFAULT CUFF INFLATION PRESSURE
Adult	178 ± 5 mmHg
Pediatric	133 ± 5 mmHg

After the first successful measurement, the subsequent inflation pressure for the same patient will be 50 ± 10 mmHg above the previous systolic pressure measurement.

Upon power ON of the **Trio**, the NIBP unit of measure defaults to the most recent setting made in the **NIBP SETUP** menu.

2.4.4.1 Cuff Application

1. Select a blood pressure cuff that is appropriate for the size of the patient. Measure the circumference of the patient's limb for the best results.

NOTE: Using a correctly sized cuff, among other considerations, has a direct bearing on the accuracy of the obtained NIBP measurements. A cuff that is too narrow for the limb will result in erroneously high readings. Selection of the cuff size should be based on the circumference of the patient's limb. The design dimensions of the cuffs and their intended use are based on recommendations made by the American Heart Association.

NOTE: Use only the authorized blood pressure cuffs and hoses listed in section 5.0, "Accessories" with the Trio.

2. Attach the NIBP cuff to the NIBP extension hose.
3. Attach the NIBP extension hose to the NIBP pneumatic fitting on the **Trio**.
4. Apply the cuff to the patient as shown in FIGURE 2-36. To reduce errors, ensure that the cuff is deflated and lies directly against the patient's skin. The cuff should fit snugly. There should be no clothing between the patient's skin and the cuff.

CAUTION: The cuff must be properly applied to the patient's limb before inflating. If it is inflated without being securely wrapped, damage to the cuff can result.

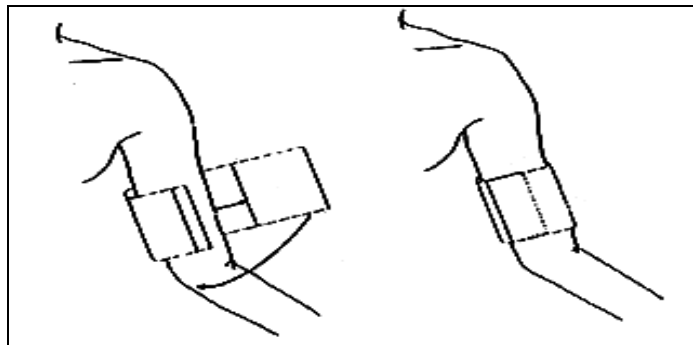

FIGURE 2-36 Application of the Blood Pressure Cuff

2.4.4.2 Measurement

1. Ensure that the appropriate **PATIENT SIZE** (Adult or Pediatric) has been selected from the **PATIENT SETUP** menu accessible from the **SYSTEM MENU**.
2. Depending on the desired measurement frequency mode, proceed as follows:

Manual Mode

Press the **NIBP** key, located on the front panel keypad, to begin the NIBP measurement.

Interval Mode

- a. Open the **NIBP SETUP** menu by selecting **NIBP** from the main display using the Navigator™ Knob. Once in the **NIBP SETUP** menu, select the **INTERVAL** Drop-Down menu and choose the desired setting.
- b. Press the **NIBP** key, located on the front panel keypad, to initiate the first measurement of the interval measurement cycle.
 - To initiate a STAT blood pressure at any time between intervals, press the **NIBP** key on the front panel keypad.
 - To exit the Interval Mode, choose **OFF** from the **INTERVAL** Drop-Down menu.

NOTE: If **CONT (Continuous)** is chosen as the interval, the monitor will take continuous blood pressure readings for five (5) minutes. After 5 minutes, the Trio will automatically revert to an Interval Mode of 5 minutes. The **NIBP** key on the front panel keypad must be pressed to initiate the new interval.

The cuff begins to inflate. After reaching the default pressure for the selected patient size, the cuff gradually deflates and the **Trio** collects oscillometric pulsations. During this inflation and deflation portion of the measurement, the current pressure in the cuff is displayed in the lower right corner of the NIBP parameter tile as "CUFF:XXX".

If a measurement cannot be obtained, the **Trio** automatically reinflates the cuff to 30 – 60 mmHg higher than the initial inflation pressure, but will not exceed the maximum cuff pressure listed in the "NIBP Sub-System Functional Requirements", section 6.2.6.5.

The patient should remain still to avoid the introduction of unnecessary motion artifact. After the cuff pressure drops below the diastolic pressure, the measurements are displayed in the NIBP parameter tile. These results will remain displayed in the **NIBP** parameter tile until the user-definable **DISPLAY TIMEOUT** interval has been reached or until a new NIBP measurement is obtained. The default **DISPLAY TIMEOUT** interval is 15 minutes.

NOTE: Pressing the **NIBP** key while the **NIBP** measurement is in progress will stop the measurement and deflate the cuff.

2.4.4.3 NIBP Display Tile

If ECG and NIBP are selected in the **MODULE SETUP** menu, NIBP will be displayed in the second parameter tile, beneath the ECG parameter tile. If ECG is not selected in the **MODULE SETUP** menu, NIBP will be displayed in the first parameter tile. The following data is displayed:

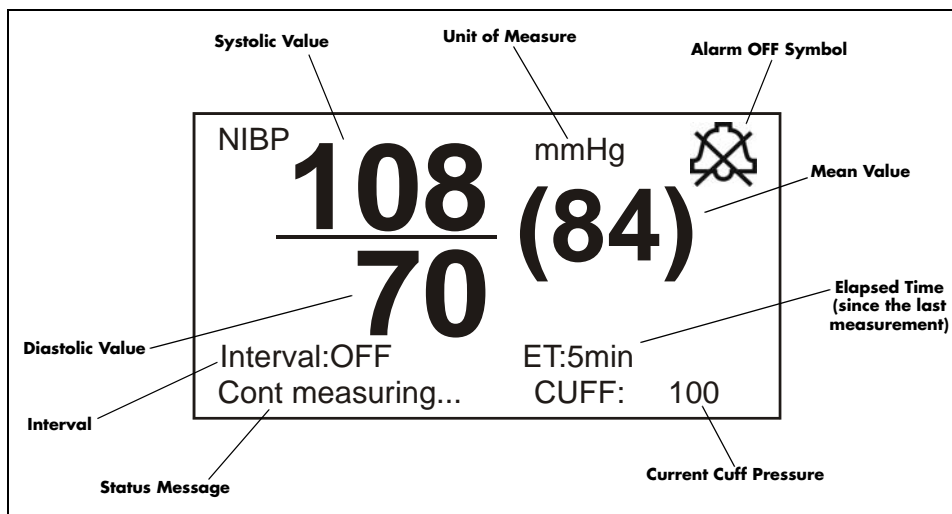

FIGURE 2-37 NIBP Parameter Tile

The following status messages may be displayed during the measurement of NIBP:

MESSAGE	CAUSE
Cont measuring...	Displayed during Continuous measuring
Auto measuring...	Displayed during Automatic / Interval measuring
Please start	Displayed after selecting an INTERVAL in the NIBP SETUP menu
Measurement over	Displayed after an NIBP measurement has been manually stopped by pressing the NIBP key during the measurement.

2.4.4.4 NIBP Setup Menu

NIBP SETUP			
ALM	OFF	DIA ALM HI	100
ALM PRIORITY	2	DIA ALM LO	50
ALM PRINT	OFF	UNITS	mmHg
SYS ALM HI	180	INTERVAL	OFF
SYS ALM LO	80	DISPLAY TIMEOUT	15min
MEAN ALM HI	100	RESTORE DEFAULTS	
MEAN ALM LO	40		
Select to return to normal screen.			
NORMAL SCREEN			

FIGURE 2-38 NIBP Setup Menu

Accessing the NIBP Setup Menu

To access the **NIBP SETUP** menu, select **NIBP** from the **NIBP** parameter tile using the Navigator™ Knob. Once in the **NIBP SETUP** menu, use the Navigator Knob to adjust settings. To close the menu, select **NORMAL SCREEN** (from the menu or the Front Panel Keypad).

NIBP Setup Menu Selections

- ALM** Allows the user to turn the **NIBP** alarm **ON** or **OFF**. Choose **ON** to enable the alarm; choose **OFF** to disable the alarm. If the alarm is set to **OFF**, the alarm **OFF** symbol  will display to the right of **NIBP** on the screen. The **NIBP** alarm is activated when the blood pressure value exceeds set high or low **NIBP** values.
- ALM PRIORITY** Allows the user to select the priority of the NIBP alarm. Choices are **1**, **2** and **3**. Priority 1 alarms are considered the most serious.
- ALM PRINT** Enables or disables automatic printing during a NIBP alarm condition. Choose **ON** to enable printing upon **NIBP** alarm. Choose **OFF** to disable printing upon **NIBP** alarm.
- SYS ALM HI** Allows the user to set the upper limit of the Systolic **NIBP** alarm. (See “NIBP Alarm Limits” on page 2-50.)
- SYS ALM LO** Allows the user to set the lower limit of the Systolic **NIBP** alarm. (See “NIBP Alarm Limits” on page 2-50.)

MEAN ALM HI	Allows the user to set the upper limit of the Mean NIBP alarm. (See “NIBP Alarm Limits” on page 2-50.)
MEAN ALM LO	Allows the user to set the lower limit of the Mean NIBP alarm. (See “NIBP Alarm Limits” on page 2-50.)
DIA ALM HI	Allows the user to set the upper limit of the Diastolic NIBP alarm. (See “NIBP Alarm Limits” on page 2-50.)
DIA ALM LO	Allows the user to set the lower limit of the Diastolic NIBP alarm. (See “NIBP Alarm Limits” on page 2-50.)
UNITS	Allows the user to select the unit of measurement for NIBP. The selections are mmHg or kPa .
INTERVAL	Allows the user to select the interval at which NIBP measurement will automatically initiate. It also allows the user to turn the automatic measurement OFF. The selections are: CONT (continuous), 1min , 2min , 3min , 4min , 5min , 10min , 15min , 30min , 1HR , 2HRS , 4HRS and OFF .
DISPLAY TIMEOUT	Allows the user to select the interval at which the NIBP measurement will time-out from the display. The selections are: 15min , 30min , 45min , and 1HR . NIBP measurement will time-out from the display when the elapsed time exceeds the chosen interval, except during an NIBP alarm condition. The time-out will be suspended until the alarm condition is resolved and will then resume. When the time-out interval has been exceeded, the NIBP measurement is replaced by dashes.
RESTORE DEFAULTS	Allows the user to restore the NIBP user default configuration.

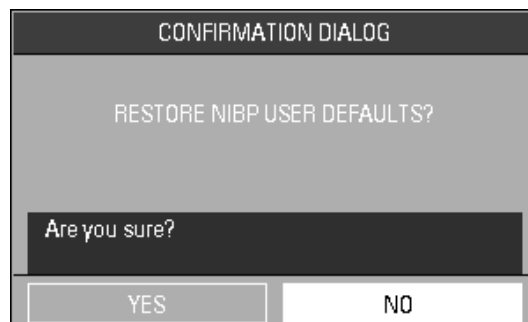

FIGURE 2-39 Confirmation Dialog Box

NIBP Alarm Limits*

PATIENT SIZE	SYS HIGH (mmHg)	SYS LOW (mmHg)	MEAN HIGH (mmHg)	MEAN LOW (mmHg)	DIA HIGH (mmHg)	DIA LOW (mmHg)
Adult (ADU)	70 – 240 [180]	50 – 150 [80]	60 – 200 [100]	40 – 140 [40]	40 – 130 [100]	30 – 120 [50]
Pediatric (PED)	40 – 180 [150]	15 – 130 [70]	50 – 180 [80]	10 – 100 [30]	50 – 100 [80]	10 – 50 [40]

* Factory default values shown in brackets.

Alarms occurring during the process of NIBP measurement include two (2) types: physiological alarms and technical alarms. Physiological alarms occur when the patient's pressure values are equal to or exceed set alarm limits. Technical alarms are any NIBP-related alarms, which are not physiological, such as functional failures.

Indirect BP Measurements and Associated Errors

Place the patient in a supine position to obtain true physiological pressure. If the cuff is not at the patient's heart level, the pressure values obtained will not reflect the true physiological pressure. Instead, the readings will be decreased by 0.75 mmHg (0.10 kPa) for every inch above heart level, and increased by 0.75 mmHg (0.10 kPa) for every inch below heart level. This is due to changes in hydrostatic pressure.

Precautions While Making Automatically Cycled Blood Pressure Measurements

Reports have been made of nerve injury occurring from automatically cycled blood pressure measurements. The following practices are recommended when making automatically cycled blood pressure measurements:

- Position and support the limb in such a way as to minimize stretching of affected nerves, as well as, weight exertion on affected nerves
- Avoid cuff placement that applies pressure on the ulnar nerve. Cuff tubing should not exit the cuff over the course of the ulnar nerve at the elbow
- Select a measurement interval that provides adequate venous drainage during cuff deflation
- Periodically inspect the limb bearing the cuff in order to detect venostasis
- If necessary, move cuff to another limb to relieve single-limb stress

Cuff Size

When applying the NIBP cuffs use the range markings as a guide to ensure proper fit and cuff size. Use of a narrow cuff may give erroneous pressure readings. If a standard cuff is applied to an obese patient or a patient with large biceps, the excess tissue will dissipate the applied pressure, requiring additional attempts to collapse the artery. This may result in high pressure readings. Over-wrapping a slender arm may also give erroneous pressure readings due to excessive force exerted on the arm.

Other Factors

An accurate determination of blood pressure can be difficult to obtain if a patient's cardiac rhythm is irregular. Irregular cardiac rhythm changes the stroke volume from beat to beat. This changing stroke volume may increase the time it takes to complete a measurement cycle.

Newborn NIBP Technique

Newborn patients present unique obstacles to NIBP measurement. Their vital signs can change frequently and their physiological signals are prone to noise interference. The following suggestions will help to obtain the best possible NIBP measurement.

- 1.** Try to measure infants when they are calm. A kicking/crying baby may disturb or dislodge the cuff causing noise within the system and as a result, yielding unstable blood pressure readings. If necessary, hold the cuffed limb steady, but do not impede circulation; do not hold onto the cuff and do not pat the cuffed limb to comfort the child.
- 2.** Try placement on the baby's calf. Irritable newborns will react to cuff pressure on the arm, but may better tolerate placement on the calf. Place the cuff just above the ankle.
- 3.** Use the correct size Newborn and Infant size cuffs. When applying, verify the cuff's Index line falls between the Range lines.
- 4.** Use disposable cuffs. Disposable cuffs are more pliant than the reusable ones. They generally fit smaller infants better.
- 5.** Gently place the cuff on the patient. If the cuff is too snug, it won't work properly. On infants, the cuff should easily move over the limb.

2.4.4.5 NIBP Troubleshooting

MESSAGE/ PROBLEM	REASON	SOLUTION
NS ALM LMT ERR	Functional failure	Notify hospital technician or Customer Support
NM ALM LMT ERR	Functional failure	Notify hospital technician or Customer Support
ND ALM LMT ERR	Functional failure	Notify hospital technician or Customer Support
NIBP SELF TEST ERR	NIBP module hardware failure	Notify hospital technician or Customer Support
NIBP COMM ERR	Communication with NIBP module has failed	Notify hospital technician or Customer Support
LOOSE CUFF	Cuff is not properly wrapped or no cuff exists	Check cuff, reapply if necessary
AIR LEAK	Cuff, hose or connector is damaged Internal Leak	Check cuff and hose connections, replace as necessary. If problem persists, notify hospital technician or Customer Support.
AIR PRESSURE ERROR	Stable pressure value is not available. e.g. hoses are pinched or occluded	Check hoses. If failure persists, notify hospital technician or Customer Support.
WEAK SIGNAL	Cuff is too loose or patient pulse is too weak	Check patient, reapply hose. Notify physician.
RANGE EXCEEDED	NIBP value exceeds the upper measurement limit	Check patient, notify physician
EXCESSIVE MOTION and/or SIGNAL SATURATED	Monitor is detecting too much motion and/or noise to obtain a reading	Instruct patient to remain still during the NIBP cuff reading. If patient is agitated, consider trying to take the pressure at a later time when patient is calm.
OVER PRESSURE	Pressure has exceeded the specified upper safety limit	Try again. If failure persists, notify hospital technician or Customer Support.
PNEUMATIC LEAK	During pneumatic test, leak is detected	Notify hospital technician or Customer Support
NIBP SYSTEM FAILURE	Operation of blood pressure pump system failed	Notify hospital technician or Customer Support
NIBP TIME OUT	Measuring time has exceeded 120 seconds	Check patient, restart NIBP measurement
MEASURE FAIL	The system cannot perform measurement, analysis or calculation	Check patient, restart NIBP measurement
Unable to obtain a BP reading	Patient movement	Wait until patient is calm or gently hold patient's limb
	Cuff or hose not attached or leaking	Check all connections
	HR irregular / arrhythmia present	Check patient, notify physician
	Blood pressure is out of range	Check patient, verify BP with manual method, notify physician
	Incorrect cuff size / brand	Measure patient's limb, verify cuff size. Use only approved accessories.

2.4.5 Temperature Monitoring

The temperature (TEMP) measurement function of the **Trio** is designed to take continuous temperature readings from the YSI 400 series probes. One (1) temperature channel is standard on the **Trio**.

1. If using a disposable temperature probe:
Connect the preferred disposable temperature probe into the reusable temperature cable. Plug the cable into the monitor.
2. If using a reusable temperature probe:
Plug the reusable probe directly into the monitor
3. Follow probe manufacturer's suggested temperature monitoring sites and suggested procedures for site checks, reapplication and moving of the probes.
4. Check the probe site frequently for position, ensuring good contact with the site chosen. For example, check the skin probe frequently to ensure good skin contact.

NOTE: **A self-test of the temperature measurement is performed automatically once per hour during the monitoring period. The test procedure lasts approximately 2 seconds and does not affect the normal measurement of the temperature monitoring.**

2.4.5.1 Temperature Setup

The screenshot shows the 'TEMP SETUP' menu with the following settings:

ALM	OFF	TEMP ALM LO	30.0
ALM PRIORITY	2	TEMP UNIT	°C
ALM PRINT	OFF	RESTORE DEFAULTS	
TEMP ALM HI	40.0	Select to return to normal screen.	

At the bottom of the screen, there is a button labeled 'NORMAL SCREEN'.

FIGURE 2-40 Temperature Setup Menu

Accessing the Temperature Setup Menu

To access the **TEMP SETUP** menu, select **TEMP** from the **TEMP** parameter tile using the Navigator™ Knob. Once in the **TEMP SETUP** menu, use the Navigator Knob to adjust settings. To close the menu, select **NORMAL SCREEN** (from the menu or the Front Panel Keypad).

Temperature Setup Menu Selections

- ALM** Allows the user to turn the **TEMP** alarm **ON** or **OFF**. Choose **ON** to enable the alarm; choose **OFF** to disable the alarm. If the alarm is set to **OFF**, the alarm **OFF** symbol  will display to the right of **TEMP** on the screen. The **TEMP** alarm is activated when the temperature value exceeds set high or low **TEMP** values.
- ALM PRIORITY** Enables priority selection for the **TEMP** alarm. Choices are **1**, **2** and **3**. Priority 1 alarms are considered the most serious.
- ALM PRINT** Enables or disables automatic printing during a **TEMP** alarm condition. Choose **ON** to enable printing upon **TEMP** alarm. Choose **OFF** to disable printing upon **TEMP** alarm.
- TEMP ALM HI** Allows the user to set the upper limit of Temperature 1 alarm. (See “Temperature Alarm Limits” on page 2-54.)
- TEMP ALM LO** Allows the user to set the lower limit of Temperature 1 alarm. (See “Temperature Alarm Limits” on page 2-54.)
- TEMP UNIT** Allows the user to select the unit of measure for temperature. The selections are **degrees Celsius (°C)** or **degrees Fahrenheit (°F)**.
- RESTORE DEFAULTS** Allows the user to restore the TEMP user default configuration.

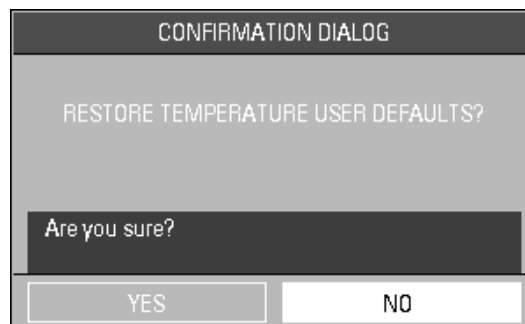

FIGURE 2-41 Confirmation Dialog Box

Temperature Alarm Limits*

	HIGH ALARM (°C)	LOW ALARM (°C)	HIGH ALARM (°F)	LOW ALARM (°F)
Temperature (T1)	35 – 43 [40]	26 – 38 [30]	95 – 109.4 [104]	78.8 – 100.4 [86]

* *Factory default values shown in brackets.*

Alarms occurring during the process of temperature measurement include two (2) types: physiological alarms and technical alarms. Physiological alarms occur when the patient’s temperature values are equal to or exceed set alarm limits. Technical alarms are any temperature-related alarms, which are not physiological, such as functional failures.

2.4.5.2 Temperature Troubleshooting

MESSAGE/ PROBLEM	REASON	SOLUTION
T1 SENSOR OFF	Temperature cable of channel 1 may be disconnected from the monitor	Make sure that the temperature cable is properly connected, check connection between probe and cable
TEMP SENSOR OFF	Temperature cable of channel 1 may be disconnected from the monitor	Make sure that the temperature cable is properly connected, check connection between probe and cable
T1 ALM LMT ERR	Functional failure	Notify hospital technician or Customer Support
TEMP ALM LMT ERR	Functional failure	Notify hospital technician or Customer Support
T1 EXCEED	Temperature value of channel exceeds measurement range	Check patient, notify physician
TEMP EXCEED	Temperature value of channel exceeds measurement range	Check patient, notify physician
Temperature Probes not working	Poor contact from probes to body	Check the body surface contact at the probe tip Reposition or apply thermoconductive gel
Temperature not displayed	Cable not plugged in	Check cable and probe

2.4.6 IBP Monitoring (Optional)

Invasive Blood Pressure (IBP) is a direct measurement of the patient's arterial or venous blood pressure. IBP utilizes a catheter that is inserted directly into a vein or artery and is connected to a transducer for interpretation of Systolic (Sys), Diastolic (Dia) and/or Mean Arterial Pressures (MAP).

The user may label the IBP channel according to the insertion site of the catheter or according to the vessel being monitored. To do this select the IBP label, located in the upper left corner of the IBP waveform tile, using the Navigator™ Knob. The labels are: **ART, PA, CVP, RAP, LAP** and **ICP**. The selection of IBP labels will alter the IBP waveform default scale.

LABEL	DEFINITION	DEFAULT SCALE (mmHg)
ART	Arterial Blood Pressure	0 – 150
PA	Pulmonary Artery Pressure	0 – 100
CVP	Central Venous Pressure	0 – 40
RAP	Right Atrial Pressure	0 – 40
LAP	Left Atrial Pressure	0 – 40
ICP	Intracranial Pressure	0 – 40

NOTE: For CVP, RAP, LAP and ICP only the Mean Arterial Pressure is measured.

NOTE: An arterial pressure catheter should not be used on a limb that is being utilized for any other medical procedure. For example, an IV catheter, NIBP measurement or SpO₂ readings.

NOTE: Please refer to pressure transducer manufacturer's instructions for suggested procedures and maintenance. Follow hospital policy regarding catheter insertion, insertion site checks and cleaning.

NOTE: Pressure transducers are protected against the effects of defibrillation and electrocautery.

NOTE: Please refer to the local hospital policy for requirements for routine zeroing and calibration of invasive pressure lines.

2.4.6.1 IBP Select Menu

The IBP Select menu allows the user to access two sub-menus: **IBP ZERO** or **IBP SETUP** (see FIGURE 2-42).

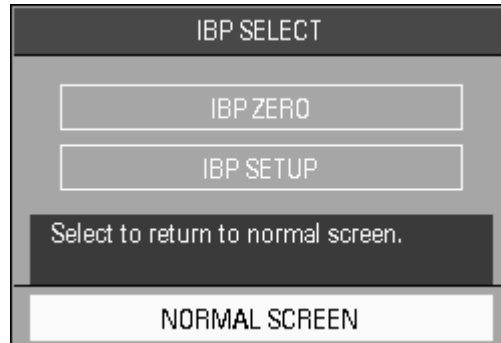

FIGURE 2-42 IBP Select Menu

Accessing the IBP Select Menu

To access the **IBP SELECT** menu, select **IBP** from the **IBP** parameter tile using the Navigator™ Knob. Once in the **IBP SELECT** menu, use the Navigator Knob to open the **IBP ZERO** menu (to zero the invasive pressure) or **IBP SETUP** menu. To close the menu, select **NORMAL SCREEN** (from the menu or the Front Panel Keypad).

Invasive Blood Pressure Monitoring

1. Plug the pressure transducer cable into the IBP connector on the side panel.
2. Connect the catheter line with flushing device to a pressure transducer, making sure the tubing is free of air bubbles.
3. Zero the pressure transducer:
 - Adjust the transducer to the mid-axillary line of the patient's chest (heart level)
 - Turn the transducer stopcock to open the transducer vent to atmosphere
 - Open the **IBP SELECT** menu by using the Navigator™ Knob to select **IBP** on the display
 - Select **IBP ZERO** from the **IBP SELECT** menu
 - Once in the **IBP ZERO** menu, select **IBP ZERO** to zero the invasive line
 - A successful message will be displayed in the **IBP ZERO** menu when the invasive line has been zeroed successfully
 - A failure message will be displayed if the transducer fails to zero



FIGURE 2-43 IBP Zero Menu

4. Label the Invasive Pressure line

- Use the Navigator™ Knob to select the IBP label located in the upper left corner of the IBP waveform tile
- Turn the Navigator Knob to scroll through the various labels. Choices are: **ART, PA, CVP, RAP, LAP,** and **ICP**
- Press the Navigator Knob to select the desired label

2.4.6.2 IBP Setup Menu

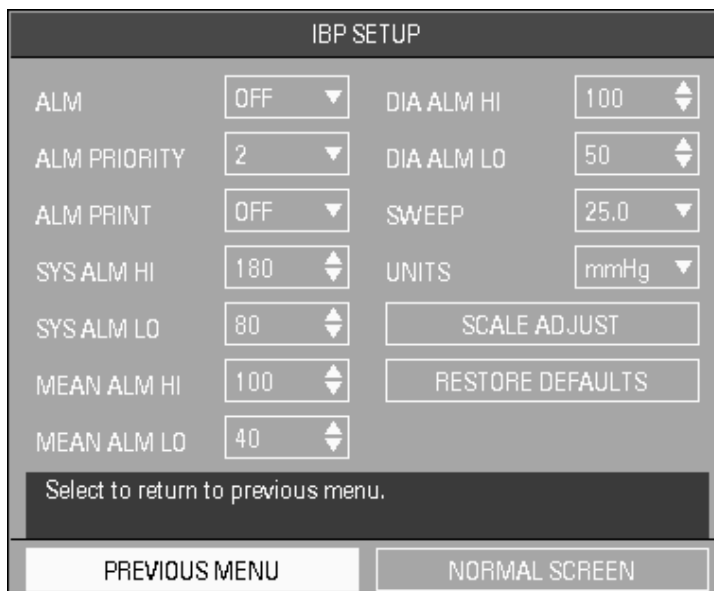



FIGURE 2-44 IBP Setup Menu

Accessing the IBP Setup Menu

To access the **IBP SELECT** menu, select **IBP** from the **IBP** parameter tile using the Navigator™ Knob. Once in the **IBP SELECT** menu, use the Navigator Knob to open the **IBP SETUP** menu. To close the menu, select **NORMAL SCREEN** (from the menu or the Front Panel Keypad).

IBP Setup Menu Selections

ALM	Allows the user to turn the IBP alarm ON or OFF . Choose ON to enable the alarm; choose OFF to disable the alarm. If the alarm is set to OFF , the alarm OFF symbol  will display to the right of IBP on the screen. The IBP alarm is activated when the blood pressure value exceeds set high or low IBP values.
ALM PRIORITY	Enables priority selection for the IBP alarm. Choices are 1 , 2 and 3 . Priority 1 alarms are considered the most serious.
ALM PRINT	Enables or disables automatic printing during an IBP alarm condition. Choose ON to enable report printing upon IBP alarm. Choose OFF to disable printing upon IBP alarm.
SYS ALM HI	Allows the user to set the upper limit of the Systolic IBP alarm. (See "IBP Alarm Limits" on page 2-61.)
SYS ALM LO	Allows the user to set the lower limit of the Systolic IBP alarm. (See "IBP Alarm Limits" on page 2-61.)
MEAN ALM HI	Allows the user to set the upper limit of the Mean Arterial Pressure IBP alarm. (See "IBP Alarm Limits" on page 2-61.)
MEAN ALM LO	Allows the user to set the lower limit of the Mean Arterial Pressure IBP alarm. (See "IBP Alarm Limits" on page 2-61.)
DIA ALM HI	Allows the user to set the upper limit of the Diastolic IBP alarm. (See "IBP Alarm Limits" on page 2-61.)
DIA ALM LO	Allows the user to set the lower limit of the Diastolic IBP alarm. (See "IBP Alarm Limits" on page 2-61.)
SWEEP	Adjusts the speed of the IBP waveform on the display. The selections are 12.5 and 25.0 mm/sec.
UNITS	Allows the user to select the units of measurement for IBP . The selections are mmHg or kPa .

SCALE ADJUST Opens the **IBP SCALE ADJUST** menu and is used to change the scale at which the invasive pressure is displayed. Scale should be adjusted to make the waveform as large as possible on the display without clipping or cutting off any part.

To adjust the scale, use the Navigator™ Knob to scroll to the desired area of the scale and select the desired limit. Three (3) scale choices are available: **HI**, **LO** and **MID**. **MID** allows the user to establish a reference line between the **HI** and **LO** set limits of the scale.

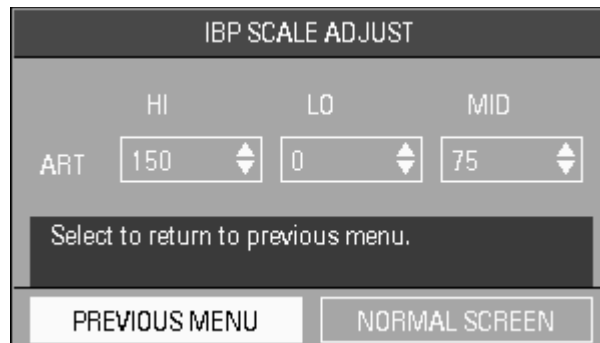

	HI	LO	MID
ART	150	0	75

Select to return to previous menu.

PREVIOUS MENU NORMAL SCREEN

FIGURE 2-45 IBP Scale Adjust Menu

**RESTORE
DEFAULTS**

Allows the user to restore the IBP user default configuration.

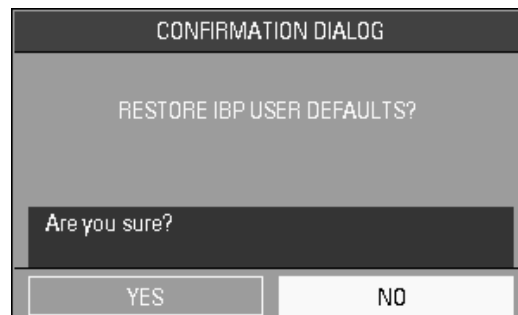

CONFIRMATION DIALOG

RESTORE IBP USER DEFAULTS?

Are you sure?

YES NO

FIGURE 2-46 Confirmation Dialog Box

IBP Alarm Limits*

	IBP LABEL	SYS HIGH (mmHg)	SYS LOW (mmHg)	MEAN HIGH (mmHg)	MEAN LOW (mmHg)	DIA HIGH (mmHg)	DIA LOW (mmHg)
ART	Adult	5 – 300 [180]	0 – 150 [80]	5 – 150 [100]	- 5 – 100 [40]	5 – 140 [100]	0 – 120 [50]
	Ped	5 – 240 [150]	0 – 130 [70]	5 – 100 [80]	- 5 – 50 [30]	5 – 100 [80]	0 – 95 [40]
PA	Adult	5 – 300 [180]	0 – 150 [80]	5 – 150 [100]	- 5 – 100 [40]	5 – 140 [100]	0 – 120 [50]
	Ped	5 – 240 [150]	0 – 130 [70]	5 – 100 [80]	- 5 – 50 [30]	5 – 100 [80]	0 – 98 [40]
CVP	Adult	n/a	n/a	5 – 150 [10]	- 5 – 100 [0]	n/a	n/a
	Ped	n/a	n/a	5 – 100 [10]	- 5 – 50 [0]	n/a	n/a
RAP	Adult	n/a	n/a	5 – 150 [10]	- 5 – 100 [0]	n/a	n/a
	Ped	n/a	n/a	5 – 100 [10]	- 5 – 50 [0]	n/a	n/a
LAP	Adult	n/a	n/a	5 – 150 [10]	- 5 – 100 [0]	n/a	n/a
	Ped	n/a	n/a	5 – 100 [10]	- 5 – 50 [0]	n/a	n/a
ICP	Adult	n/a	n/a	5 – 150 [10]	- 5 – 100 [0]	n/a	n/a
	Ped	n/a	n/a	5 – 100 [10]	- 5 – 50 [0]	n/a	n/a

* *Factory default values shown in brackets.*

Alarms occurring during the process of IBP measurement include two (2) types: physiological alarms and technical alarms. Physiological alarms occur when the patient's pressure values are equal to or exceed set alarm limits. Technical alarms are any IBP-related alarms, which are not physiological, such as functional failures.

2.4.6.3 IBP Troubleshooting

MESSAGE/ PROBLEM	REASON	SOLUTION
SENSOR OFF, FAIL	Transducer may be disconnected during attempt to zero	Check transducer and cables for connection. If problem persists, notify hospital technician or Customer Support
IN DEMO FAIL	Monitor is in DEMO mode during attempt to zero	Turn monitor OFF. Turn ON to return to normal monitoring mode
PRESSURE OVER RANGE, FAIL	Stopcock not open to atmosphere	Turn stopcock to atmosphere prior to zero attempt. If problem persists, notify hospital technician or Customer Support
PULSATILE PRESSURE, FAIL	Stopcock is not open to atmosphere and a pulsatile pressure has been detected	Turn stopcock to atmosphere prior to zero attempt. If problem persists, notify hospital technician or Customer Support
IBP SENSOR OFF	IBP cable may be disconnected from monitor	Make sure that cable is properly connected
IBP INIT ERR1	Module failure	Notify hospital technician or Customer Support
IBP COMM STOP	Module failure or communication failure	Notify hospital technician or Customer Support
IBP COMM ERR	Communication error	Notify hospital technician or Customer Support
IBP ALM LMT ERR	Functional failure	Notify hospital technician or Customer Support
IBP SYS EXCEED	Systolic pressure value exceeds measurement range	Check patient, notify physician
IBP DIA EXCEED	Diastolic pressure value exceeds measurement range	Check patient, notify physician
IBP MAP EXCEED	Mean arterial pressure value exceeds measurement range	Check patient, notify physician
IBP NEED ZERO-CAL	Zero calibration must be performed before measuring IBP	Zero calibration must be performed. Notify hospital technician or Customer Support.
Dampened Invasive Waveform	Air bubbles in tubing	Eliminate air from tubing
	Kinked invasive catheter	Change position of catheter, check patient
	Catheter against wall of blood vessel	Check for leaks at connector, flush catheter
	Blood in tubing	Pump pressure bag up to 300 mmHg
IBP not Displayed / No Waveform	Catheter partially occluded	Consult physician
	Cable not plugged in	Check cable connections
	Transducer not connected	Check transducer connections
	Stopcock turned improperly	Check transducer for proper alignment
Abnormally high or low readings	Transducer not zeroed	Check and zero the transducer
	Transducer too HIGH or too LOW in relation to patient's heart	Check patient, adjust transducer, re-zero

2.5 Alarms

The **Trio** provides audio and visual alarms to indicate:

- The functional status of the monitor
- That the measured parameter values are equal to or exceed the alarm limits

These alarms are divided into three categories: Physiological, Technical and General. Alarms in each category are classified in one of three levels based on their degree of severity. These levels are Priority 1, 2 or 3.

When the **Trio** is turned ON, an audible tone and the alarm light will indicate that the audio and visual alarm functions of the monitor are working properly. If the tone is not heard and/or the alarm light does not flash when the unit is turned ON, contact the hospital biomedical technician or a Customer Service representative.

Technical and General alarm messages will display in the message area located in the upper right portion of the **Trio** display, with the exception of the NIBP technical alarms. NIBP technical alarms will display at the bottom of the NIBP parameter tile.

2.5.1 Alarm Categories

Physiological Alarms

Physiological alarms are alarms prompted by changes in the patient's medical condition. These alarms occur when the patient's vital signs are equal to or exceed set alarm limits.

Alarm limits are available for Heart Rate (HR), Systolic (SYS) blood pressure, Diastolic (DIA) blood pressure, Mean Arterial Pressure (MEAN), Respiration (RESP), SpO₂ and Temperature (TEMP). All of these alarm limits have an **OFF** selection with the exception of SpO₂ alarm low. Each of these parameters has default alarm limits. However, parameter alarm limits can be customized based on the individual patient's needs.

NOTE: In the French configuration, the HR (Heart Rate) alarm is always ON. It cannot be disabled by turning it OFF.

A physiological alarm will occur when the parameter alarm is set to **ON** and the measured value is equal to or exceeds the set alarm limit. Alarms will not activate if the alarm is set to **OFF**.

If **ALARM PRINT** is set to **ON** for a given parameter, a printed record will automatically be generated when the parameter value is equal to or exceeds the set alarm limits.

Technical Alarms

Technical alarms refer to a communication error or functional failure, which require resolution or attention to continue patient monitoring. Technical alarms are also called System Errors.

Upon detecting a system error, the monitor alarms immediately. If more than one (1) technical alarm occurs, each alarm will cycle until the associated error is resolved.

General Alarms

General alarms are alerts that cannot be classified as physiological or technical, but that require attention. General alarms are not related to patient medical condition.

2.5.2 Alarm Priorities

Alarms in each category (Physiological, Technical or General) are classified based on their degree of severity. The priority determines the frequency of audio and visual alerts. There are two (2) visual alerts: the alarm light and the alarm-related message on the display. For an **ECG Lead Off** alarm, the alarm will sound according to the ECG priority setting.

- 1. Priority One (1) Alarm:** This alarm requires an urgent and immediate response from the clinician. The numeric value of the alarming parameter will flash at a constant rate in black text on a red background. The alarm light will flash red with high frequency. The audio alert cycles once every ten (10) seconds.
- 2. Priority Two (2) Alarm:** This alarm requires a serious response and consideration by the clinician. The numeric value of the alarming parameter will flash at a constant rate in black text on a yellow background. The alarm light flashes amber with a slow frequency. The audio alert cycles once every 25 seconds.
- 3. Priority Three (3) Alarm:** This alert should be attended to as soon as possible by the clinician. The numeric value of the alarming parameter displays in black text on a yellow background and does not flash. The alarm light will be amber and does not flash. The audio alert cycles once every 25 seconds.

All physiological alarms can be changed by the clinician. Technical alarm priorities are preset in the system and can not be changed. The alert message for technical alarms displays on a yellow background. To change the parameter alarm priorities, open the individual **PARAMETER SETUP** menus and select the priority desired. Parameter alarm priorities may also be adjusted in the **ALARM SETUP** menu.

NOTE: When alarms of different priorities occur simultaneously, the monitor will display the alarm with the highest priority.

2.5.3 Alarm Setup Menus

The Alarm Setup Menus enable the customization of the **COMMON ALARM SETUP** as well as the **ALARM SETUPs** for the following individual parameters: **HR**, **SPO2**, **NIBP**, **IBP**, **RESP**, and **TEMP**.

2.5.3.1 Accessing the Alarm Setup Menus

- Using the Navigator™ Knob, select **ALARM SETUP** from the **MONITOR SETUP** menu. The default **ALARM SETUP** menu is the **COMMON ALARM SETUP** as shown in FIGURE 2-47.
- Use the **ALM SEL** Drop-Down menu to access the **ALARM SETUP** menu for a specific parameter. The choices are: **HR ALARM SETUP**, **SPO2 ALARM SETUP**, **NIBP ALARM SETUP**, **IBP ALARM SETUP**, **RESP ALARM SETUP**, and **TEMP ALARM SETUP**. The selected **ALARM SETUP** menu will determine the other available menu selections.

NOTE: For more information on parameter alarms and instructions for setting these alarms, refer to the parameter-specific section of this Operator's Manual.

COMMON ALARM SETUP Menu Selections

FIGURE 2-47 Common Alarm Setup Menu

ALM SEL Choose **COMMON ALARM SETUP**.
(Alarm Selection)

ALARM VOL Volume of the audio alert. Selections are: **LOW**, **MED**, and **HIGH**.

ALM PRINT TIME Length of the printed waveform. Selections are: **8s**, **16s**, or **32s**.

ALM MUTE TIME Length of time for the alarm to be silenced. Selections are: **1min**, **2min**, **5min**, **10min**, and **PERMANENT**.

When **ALM MUTE TIME** is set to **PERMANENT** and Alarm Mute is active, the message “Alarms Permanently Muted” displays at a constant rate in the technical alarms area.

- If another technical alarm occurs at the same time, both messages will display alternately.
- If the **ALM MUTE TIME** is changed to something other than **PERMANENT**, the following conditions will exist:
 - The elapsed time is defined as the time from which **ALM MUTE TIME** had been set to **PERMANENT** to the time at which it was changed to something other than **PERMANENT**.
 - If the elapsed time exceeds the newly selected **ALM MUTE TIME**, then the Alarm Mute will immediately deactivate.
Example: Elapsed time = 5min, New **ALM MUTE TIME** = 2min, Alarm Mute immediately deactivates.
 - If the elapsed time is less than the newly selected **ALM MUTE TIME**, then the Alarm Mute will continue to be active for the remainder of the newly selected time period.
Example: Elapsed time = 2min, New **ALM MUTE TIME** = 10min, Alarm Mute continues to be active for 8 minutes and then deactivates.

HR ALARM SETUP Menu Selections

FIGURE 2-48 HR Alarm Setup Menu

ALM SEL
(Alarm Selection)

Choose **HR ALARM SETUP**.

ALM

NOTE: In the French configuration, the HR (Heart Rate) alarm is always **ON**. It cannot be disabled by turning it **OFF**.

Allows the user to turn the HR (Heart Rate) alarm **ON** or **OFF**. Choose **ON** to enable the alarm; choose **OFF** to disable the alarm. If the alarm is set to **OFF**, the alarm **OFF** symbol  will display to the right of **ECG** on the screen. The HR alarm is activated when the heart rate is equal to or exceeds set high or low HR values.

ALM PRIORITY

Allows the user to select the priority of the alarm. Choices are **1**, **2** and **3**. Priority 1 alarms are considered the most serious.

ALM PRINT

Allows the user to enable or disable automatic printing during a physiological alarm condition. Choose **ON** to enable printing upon alarm. Choose **OFF** to disable printing upon alarm. See “Recorder (Optional)” on page 2-82 for details.

HR ALM HI

Allows the user to set the upper limit of the **HR** alarm. (See “Heart Rate Alarm Limits” on page 2-27.)

HR ALM LO

Allows the user to set the lower limit of the **HR** alarm. (See “Heart Rate Alarm Limits” on page 2-27.)

SPO2 ALARM SETUP Menu Selections

FIGURE 2-49 SPO2 Alarm Setup Menu (Masimo® only)

FIGURE 2-50 SPO2 Alarm Setup Menu (Nellcor® only)

NOTE: See the appropriate subsection of the “SpO2 Monitoring” section for the alarm limits

ALM SEL Choose **SPO2 ALARM SETUP**.
(Alarm Selection)

ALM PRIORITY Allows the user to select the priority of the alarm. Choices are **1**, **2** and **3**. Priority 1 alarms are considered the most serious.

ALM PRINT	Allows the user to enable or disable automatic printing during a physiological alarm condition. Choose ON to enable printing upon alarm. Choose OFF to disable printing upon alarm. See “Recorder (Optional)” on page 2-82 for details.
SPO2 ALM HI	Allows the user to set the upper limit of the SPO2 alarm. Choices are 80 – 100% and OFF. Choose OFF to disable the alarm. If the alarm is set to OFF , the alarm OFF symbol  will display within the parameter tile. The alarm is activated when the measurement equals or exceeds the high limit.
SPO2 ALM LO	Allows the user to set the lower limit of SPO2 alarm.
PR ALM HI	Allows the user to set the upper limit of the Pulse Rate alarm.
PR ALM LO	Allows the user to set the lower limit of the Pulse Rate alarm.
SENSOR OFF AUDIO	<p>Controls the onset of the audio beep alarm for the “SpO2 Sensor OFF” condition. The choices are ON and OFF.</p> <p>If ON is selected, then the audio beep alarm will sound when an “SpO2 Sensor OFF” condition occurs. If OFF is selected, then the audio beep alarm will not sound when an “SpO2 Sensor OFF” condition occurs.</p>
SAT SECONDS (Nelcor® only)	<p>Controls pulse oximetry nuisance alarms (see section 2.4.3.2 for details on SatSeconds™ features). The selections are OFF, 10, 25, 50 or 100.</p> <p>When SatSeconds is enabled, the SPO2 Low and High Alarm functions are automatically disabled. As a safety precaution, if three (3) SPO2 alarm violations occur within 60 seconds, a priority 2 alarm will trigger even if the SatSeconds limit has not been reached.</p>

NIBP ALARM SETUP Menu Selections

FIGURE 2-51 NIBP Alarm Setup Menu

ALM SEL

(Alarm Selection)

Choose **NIBP ALARM SETUP**.

ALM

Allows the user to turn the alarm **ON** or **OFF**. Choose **ON** to enable the alarm; choose **OFF** to disable the alarm. If the alarm is set to **OFF**, the alarm **OFF** symbol  will display within the parameter tile. The alarm is activated when the measurement exceeds the high or low limits.

ALM PRIORITY

Allows the user to select the priority of the alarm. Choices are **1**, **2** and **3**. Priority 1 alarms are considered the most serious.

ALM PRINT

Allows the user to enable or disable automatic printing during a physiological alarm condition. Choose **ON** to enable printing upon alarm. Choose **OFF** to disable printing upon alarm. See "Recorder (Optional)" on page 2-82 for details.

SYS ALM HI

Allows the user to set the upper limit of the Systolic **NIBP** alarm. (See "NIBP Alarm Limits" on page 2-50.)

SYS ALM LO

Allows the user to set the lower limit of the Systolic **NIBP** alarm. (See "NIBP Alarm Limits" on page 2-50.)

MEAN ALM HI

Allows the user to set the upper limit of the Mean **NIBP** alarm. (See "NIBP Alarm Limits" on page 2-50.)

- MEAN ALM LO** Allows the user to set the lower limit of the Mean **NIBP** alarm.
(See "NIBP Alarm Limits" on page 2-50.)
- DIA ALM HI** Allows the user to set the upper limit of the Diastolic **NIBP** alarm.
(See "NIBP Alarm Limits" on page 2-50.)
- DIA ALM LO** Allows the user to set the lower limit of the Diastolic **NIBP** alarm.
(See "NIBP Alarm Limits" on page 2-50.)

IBP ALARM SETUP Menu Selections

The screenshot shows the 'IBP ALARM SETUP' menu. At the top, the title 'IBP ALARM SETUP' is displayed. Below it is a dropdown menu labeled 'ALM SEL' with 'IBP ALARM SETUP' selected. The menu contains several settings, each with a dropdown or numeric input field:

- ALM: OFF
- ALM PRIORITY: 2
- ALM PRINT: OFF
- SYS ALM HI: 180
- SYS ALM LO: 80
- MEAN ALM HI: 100
- MEAN ALM LO: 40
- DIA ALM HI: 100
- DIA ALM LO: 50

At the bottom of the menu, there is a dark bar with the text 'Select to return to previous menu.' Below this bar are two buttons: 'PREVIOUS MENU' and 'NORMAL SCREEN'.

FIGURE 2-52 IBP Alarm Setup Menu

ALM SEL

(Alarm Selection)

Choose **IBP ALARM SETUP**.

ALM

Allows the user to turn the alarm **ON** or **OFF**. Choose **ON** to enable the alarm; choose **OFF** to disable the alarm. If the alarm is set to **OFF**, the alarm **OFF** symbol  will display within the parameter tile. The alarm is activated when the measurement exceeds the high or low limits.

ALM PRIORITY

Allows the user to select the priority of the alarm. Choices are **1**, **2** and **3**. Priority 1 alarms are considered the most serious.

ALM PRINT

Allows the user to enable or disable automatic printing during a physiological alarm condition. Choose **ON** to enable printing upon alarm. Choose **OFF** to disable printing upon alarm. See "Recorder (Optional)" on page 2-82 for details.

SYS ALM HI

Allows the user to set the upper limit of the Systolic **IBP** alarm. (See "IBP Alarm Limits" on page 2-61.)

SYS ALM LO

Allows the user to set the lower limit of the Systolic **IBP** alarm. (See "IBP Alarm Limits" on page 2-61.)

MEAN ALM HI

Allows the user to set the upper limit of the Mean **IBP** alarm. (See "IBP Alarm Limits" on page 2-61.)

- MEAN ALM LO** Allows the user to set the lower limit of the Mean **IBP** alarm.
(See "IBP Alarm Limits" on page 2-61.)
- DIA ALM HI** Allows the user to set the upper limit of the Diastolic **IBP** alarm.
(See "IBP Alarm Limits" on page 2-61.)
- DIA ALM LO** Allows the user to set the lower limit of the Diastolic **IBP** alarm.
(See "IBP Alarm Limits" on page 2-61.)

RESP ALARM SETUP Menu Selections

The screenshot shows the 'ALARM SETUP' menu. At the top, the title 'ALARM SETUP' is centered. Below it is a dropdown menu labeled 'ALM SEL' with 'RESP ALARM SETUP' selected. The main area contains five rows of settings, each with a label and a control element: 'ALM' with a dropdown set to 'OFF', 'ALM PRIORITY' with a dropdown set to '2', 'ALM PRINT' with a dropdown set to 'OFF', 'ALM HI' with a numeric keypad set to '30', and 'ALM LO' with a numeric keypad set to '10'. At the bottom, there is a dark bar with the text 'Select to return to previous menu.' and two buttons: 'PREVIOUS MENU' and 'NORMAL SCREEN'.

FIGURE 2-53 RESP Alarm Setup Menu

ALM SEL (Alarm Selection)	Choose RESP ALARM SETUP .
ALM	Allows the user to turn the alarm ON or OFF . Choose ON to enable the alarm; choose OFF to disable the alarm. If the alarm is set to OFF , the alarm OFF symbol  will display within the parameter tile. The alarm is activated when the measurement exceeds the high or low limits.
ALM PRIORITY	Allows the user to select the priority of the alarm. Choices are 1 , 2 , and 3 . Priority 1 alarms are considered the most serious.
ALM PRINT	Allows the user to enable or disable automatic printing during a physiological alarm condition. Choose ON to enable printing upon alarm. Choose OFF to disable printing upon alarm. See "Recorder (Optional)" on page 2-82 for details.
ALM HI	Allows the user to set the upper limit of the RESP alarm. (See "Respiration Rate Alarm Limits" on page 2-30.)
ALM LO	Allows the user to set the lower limit of the RESP alarm. (See "Respiration Rate Alarm Limits" on page 2-30.)

TEMP ALARM SETUP Menu Selections

TEMP ALARM SETUP

ALM SEL TEMP ALARM SETUP ▼

ALM OFF ▼

ALM PRIORITY 2 ▼

ALM PRINT OFF ▼

TEMP ALM HI 40.0 ▲▼

TEMP ALM LO 30.0 ▲▼

Select to return to previous menu.

PREVIOUS MENU NORMAL SCREEN

FIGURE 2-54 TEMP Alarm Setup Menu

ALM SEL
(Alarm Selection)

Choose **TEMP ALARM SETUP**.

ALM

Allows the user to turn the alarm **ON** or **OFF**. Choose **ON** to enable the alarm; choose **OFF** to disable the alarm. If the alarm is set to **OFF**, the alarm **OFF** symbol  will display within the parameter tile. The alarm is activated when the measurement exceeds the high or low limits.

ALM PRIORITY

Allows the user to select the priority of the alarm. Choices are **1**, **2**, and **3**. Priority 1 alarms are considered the most serious.

ALM PRINT

Allows the user to enable or disable automatic printing during a physiological alarm condition. Choose **ON** to enable printing upon alarm. Choose **OFF** to disable printing upon alarm. See “Recorder (Optional)” on page 2-82 for details.

TEMP ALM HI

Allows the user to set the upper limit of the **TEMP** alarm. (See “Temperature Alarm Limits” on page 2-54.)

TEMP ALM LO

Allows the user to set the lower limit of the **TEMP** alarm. (See “Temperature Alarm Limits” on page 2-54.)

Alarm Mute

The **ALARM MUTE** function is used to silence parameter alarms that have been triggered. Press the **ALARM MUTE** key on the Front Panel Keypad to activate the **ALARM MUTE** function. When **ALARM MUTE** is active, press the key a second time to deactivate the function. The amount of time the alarm is silenced is programmable through the **ALARM SETUP** menu. Any new alarms that occur during the silenced period will disable the **ALARM MUTE** function in order for the new alarm to sound.

An **ALARM MUTE** icon  will be displayed in the message bar when the **ALARM MUTE** function is active.

When an Alarm Occurs

Always check the patient to verify the alarm and identify the cause of the alarm. Artifact, patient movement and other non-physiological conditions may cause false alarms. Verify the nature and cause of the alarm, mute the alarm as necessary. Check all patient connections for sensor connections and cable integrity. Change physiological alarm limits if necessary. Notify physician if change in patient condition occurs.

2.5.4

Alarm Troubleshooting

MESSAGE/ PROBLEM	REASON	SOLUTION
REAL CLOCK NEED SET	System displays 2000-1-1, the clock has not been set	Reset system time. After modifying the time, restart the monitor to display correct time
REAL CLOCK NOT EXIST	The system has no battery or the battery is depleted	Notify hospital biomedical technician or Customer Support
KEYBOARD COMM ERR and/or KEYBOARD ERROR and/or KEYBOARD ERR X	The system has detected a keypad error or failure. NOTE: X = 1 or 2.	Restart the system. If alert persists, notify hospital biomedical technician or Customer Support
CELL BAT TOO HIGH	Cell battery is defective or incorrect cell battery is installed	Check the battery, replace if necessary. If the failure still exists, notify hospital technician or Customer Support
CELL BAT TOO LOW	The cell battery has low capacity, the cell battery is not installed or the connection is loose	Check the battery, replace if necessary. If the failure still exists, notify hospital technician or Customer Support

2.6 Trends

2.6.1 Graphic Trend

The Graphic Trend display allows the user to view a graphic summary of stored vital sign data. The most recent 1-hour of graphic trend data can be displayed in intervals of **1** or **5** seconds. The most recent 24-hours of graphic trend data can be displayed in intervals of **1**, **2**, **3** or **4** minutes. Select **GRAPHIC TREND** from the **SYSTEM MENU** to access this menu/display (see FIGURE 2-55).

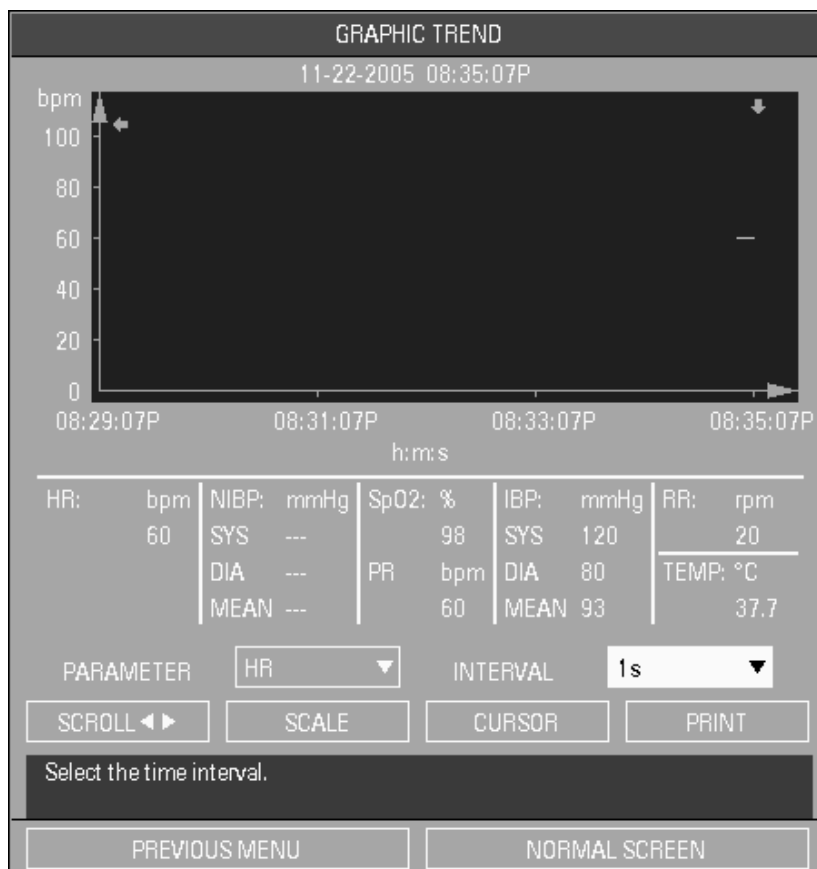

FIGURE 2-55 Graphic Trend Menu/Display

In the Graphic Trend display, time stamps are plotted horizontally along the x-axis, with the most recent data appearing on the far right. The values of the trended parameter, and the corresponding units of measurement are plotted vertically, along the y-axis. The down arrow symbol ▼ indicates that the value of the parameter which it points to, falls below the x-axis. All trends, except NIBP trend, are displayed as continuous waveforms. When viewing the NIBP graphic trend, the ▼ symbol indicates systolic value, the ▲ symbol indicates diastolic value, and * indicates mean value.

NOTE: When the monitor is powered OFF, graphic trend data is maintained for 2 hours. If the monitor remains OFF for more than 2 hours, the graphic trend data is deleted.

Graphic Trend Menu Selections

1. PARAMETER

- To change the parameter of data being displayed, select **PARAMETER** from the **GRAPHIC TREND** menu. Using the Navigator™ Knob, scroll to the desired parameter and press the knob.
- The selections are: **HR**, **NIBP**, **SpO2**, **PR**, **IBP**, **RR**, and **TEMP**.

2. INTERVAL

- To change the displayed **INTERVAL**, select **INTERVAL** from the **GRAPHIC TREND** menu. (The chosen interval can be saved as part of the “**User Default Configuration**” by using the **SAVE CURRENT** function as described in section 2.3.5.9.)
- To view the latest hour of trended data, select either the **1s** or **5s** interval.
- To view the latest 24-hours of trended data, select the **1min**, **2min**, **3min** or **4min** interval.

3. SCROLL ◀▶

- To view other segments of a graphic trend, select **SCROLL** from the **GRAPHIC TREND** menu.
- When the right arrow key ▶ appears on the right side of the menu display, select **SCROLL** ◀▶ and turn the Navigator™ Knob clockwise to view older trend waveform data.
- When the left arrow key ◀ appears on the left side of the menu display, select **SCROLL** ◀▶ and turn the Navigator Knob counterclockwise to view more recent trend data.

4. SCALE

- To modify the scale upon which the graphic trend is displayed, select **SCALE** from the **GRAPHIC TREND** menu. The y-axis scale is adjustable based on the minimum and maximum values for the particular parameter.

5. CURSOR

To view trend data at a specific point in time, select **CURSOR** from the **GRAPHIC TREND** menu:

- Turn the knob to move the cursor to particular data points. The data to which the cursor points will correspond to the time displayed. The parameter data corresponding to the particular point in time is displayed below the x-axis.
- When ▶ appears in the upper right portion of the menu, the user can scroll right to view more recent trend data.
- When ◀ appears in the upper left portion of the menu, the user can scroll left to view older trend data.

6. PRINT

- To print the graphic trend data for the currently selected parameter, select **PRINT** from the **GRAPHIC TREND** menu.
- To stop the print job currently in progress, select **PRINT** on the front panel keypad.

Mark Event

If, during the trended period of time, an event was marked, the corresponding event type (**A**, **B**, **C** or **D**) will display along the x-axis of the graphic trend. The event (**A**, **B**, **C** or **D**) will appear in a box, at the corresponding point in time that the event was marked.

Remove Graphic Trend Display

The **GRAPHIC TREND** menu/display does not automatically time-out. The user must manually exit this menu. To exit the **GRAPHIC TREND** menu/display and return to the **SYSTEM MENU**, select **PREVIOUS MENU**. To exit the **GRAPHIC TREND** menu/display and return to the normal screen, select **NORMAL SCREEN** (from the menu or the Front Panel Keypad).

Delete Graphic Trend Data

To permanently delete all graphic trend data, the user must discharge the currently monitored patient from the monitor. To discharge a patient, open the **SYSTEM MENU**. Once in the **SYSTEM MENU**, select **PATIENT DISCHARGE** from the **PATIENT SETUP** menu. When given the prompt, **Discharge patient from monitor?**, select **YES** to confirm.

Example: View the NIBP Graphic Trend for the Last Hour

1. Select the **MENU** icon in the bottom right corner of the screen.
2. Once in the **SYSTEM MENU**, select **GRAPHIC TREND**.
3. Once in the **GRAPHIC TREND** menu select **PARAMETER** then select **NIBP**.
4. Select **INTERVAL** and select either the **1s** (1 second) or **5s** (5 second) interval.
5. Select **SCROLL** and turn the knob to view different points along the graphic trend (x-axis).
6. Stop scrolling at the desired trend time segment for closer analysis. Select the **SCALE** button to adjust the display scale, on the y-axis, if desired.
7. For a measurement result of a specific point in time, select **CURSOR** to move the cursor to the desired point. The corresponding time and measurement value will display above and below the waveform respectively.
8. To print out the NIBP graphic trend displayed, select **PRINT** from the **GRAPHIC TREND** menu.
9. Select **PREVIOUS MENU** to return to the **SYSTEM MENU**. Select **NORMAL SCREEN** (from the menu or the Front Panel Keypad) to exit the menu and return to the normal screen.

2.6.2 List Trend

The List Trend display allows the user to view a tabular list of stored vital sign data. Select **LIST TREND** from the **SYSTEM MENU** to access this menu/display (see FIGURE 2-56). A maximum of 24 hours of data may be stored. When List Trend reaches the maximum number of data entries, the oldest entry will be deleted from the trend record in order to allow storage of a new entry. The List Trend data can be set to display in **1min, 2min, 3min, 4min, 5min, 10min, 15min, 30min, or 1HR** intervals.

LIST TREND										
TIME	EVENT	HR	NIBP			SpO2	PR	IBP		
(Day) Time		bpm	mmHg			%	bpm	mmHg		
			Sys	Dia	Mean			Sys	Dia	Mean
(22)08:37P		60	---	---	---	98	60	120	80	93
(22)08:36P		60	108	70	84	98	60	120	80	93
(22)08:35P		---	---	---	---	---	---	---	---	---
(22)08:34P		---	---	---	---	---	---	---	---	---
(22)08:33P		---	---	---	---	---	---	---	---	---
(22)08:32P		---	---	---	---	---	---	---	---	---
(22)08:31P		---	---	---	---	---	---	---	---	---
(22)08:30P		---	---	---	---	---	---	---	---	---
(22)08:29P		---	---	---	---	---	---	---	---	---
(22)08:28P		---	---	---	---	---	---	---	---	---
(22)08:27P		---	---	---	---	---	---	---	---	---
(22)08:26P		---	---	---	---	---	---	---	---	---

▼

INTERVAL: 1min ▼ SCROLL ▲▼ SCROLL ◀▶ PRINT

Select to return to previous menu.

PREVIOUS MENU NORMAL SCREEN

FIGURE 2-56 List Trend Menu/Display

In the List Trend display, time stamps are displayed in the far left column, with the most recent data appearing at the top. Any alarm violations appearing in the list trend view are indicated by inverse video. The **LIST TREND** displays several parameters of data at a time. Parameter data displays from left to right, in the following order: **HR, NIBP, SpO2, PR, IBP, RESP** and **TEMP**. Use the **SCROLL** key to view additional parameter data.





NOTE: **When the monitor is powered OFF, list trend data is maintained for 2 hours. If the monitor remains OFF for more than 2 hours, the list trend data is deleted.**

List Trend Menu Selections

1. INTERVAL



- To change the **INTERVAL**, select **INTERVAL** from the **LIST TREND** menu. (The chosen interval can be saved as part of the “**User Default Configuration**” by using the **SAVE CURRENT** function as described in section 2.3.5.9.)
- Select from intervals of in **1min, 2min, 3min, 4min, 5min, 10min, 15min, 30min, or 1HR**.

2. SCROLL

- When an upward facing arrow  appears on the upper portion of the menu, select **SCROLL ** and turn the knob clockwise to view more recent trend data.
- When a downward facing arrow  appears on the lower portion of the menu, select **SCROLL ** and turn the knob counterclockwise to view older trend data.

3. SCROLL

Select **SCROLL ** to select the parameter group for which a view of trend data is desired. Trend data for each parameter is displayed as follows:

- HR (bpm)
- NIBP (Sys/Dia/Mean) (mmHg or kPa)
- SpO2 (%), PR (bpm)
- IBP (Sys/Dia/Mean) (mmHg or kPa)
- RESP (rpm)
- TEMP (°C or °F)
- When a  is displayed in the lower right corner of the menu, the user can scroll right to view additional parameter data.
- When a  is displayed in the lower left corner of the menu, the user can scroll left to view additional parameter data.

4. PRINT

- To print the list trend data for all parameters, select **PRINT** from the **LIST TREND** menu.
- To stop the print job currently in progress, select **PRINT** on the front panel keypad.

Mark Event

The **EVENT** column of the **LIST TREND** menu displays time stamp event markers (**A, B, C, or D**) that have been entered in the trend memory from the **MARK EVENT** menu (see section 2.3.4). The time stamp event markers are displayed in the **EVENT** column at the corresponding trend entry time.



Remove List Trend Display

The **LIST TREND** menu/display does not automatically time-out. The user must manually exit this menu. To exit the **LIST TREND** menu/display and return to the **SYSTEM MENU**, select **PREVIOUS MENU**. To exit the **LIST TREND** menu/display and return to the normal screen, select **NORMAL SCREEN** (from the menu or the Front Panel Keypad).

Delete List Trend Data

To permanently delete all list trend data, the user must discharge the currently monitored patient from the monitor. To discharge a patient, open the **SYSTEM MENU**. Once in the **SYSTEM MENU**, select **PATIENT DISCHARGE** from the **PATIENT SETUP** menu. When given the prompt, **Discharge patient from monitor?**, select **YES** to confirm.

Example: View NIBP List Trend Data

1. Select the **MENU** icon in the lower right corner of the display to access the **SYSTEM MENU**.
2. Select **LIST TREND**.
3. Select **SCROLL**  and select **NIBP** by turning the knob clockwise.
4. Select **INTERVAL** and scroll to the desired time interval.
5. Select  **SCROLL** and turn the knob to view NIBP trend data for a different time segment.
6. Select **PRINT** to initiate a printout of all trend data of this time segment, including NIBP.
7. Select **PREVIOUS MENU** to return to the **SYSTEM** menu. Select **NORMAL SCREEN** (from the menu or the Front Panel Keypad) to exit the menu and return to normal screen.

2.7 Recorder (Optional)

The optional **Trio** Recorder provides a printed record of all patient monitored parameters, including numeric and waveform data. It is a two-trace thermal strip chart recorder. The **Trio** recorder uses plain white thermal paper, 50mm wide (part number 0683-00-0505-02.) See section 4.7 for Paper Replacement Instructions.

2.7.1 Print Functions

The **Trio** performs the following print functions:

- Continuous, real-time print
- 8 second, real-time print
- Interval, real-time print
- Alarm print
- Graphic/List Trend print
- Error log print
- Clear print tasks

Accessing the Printer Setup Menu

1. Select the **MENU** icon from the main screen. The **SYSTEM MENU** is displayed.
2. Select **MONITOR SETUP**. The **MONITOR SETUP** menu is displayed.
3. Select **PRINTER SETUP**. The **PRINTER SETUP** menu (FIGURE 2-57) is displayed.

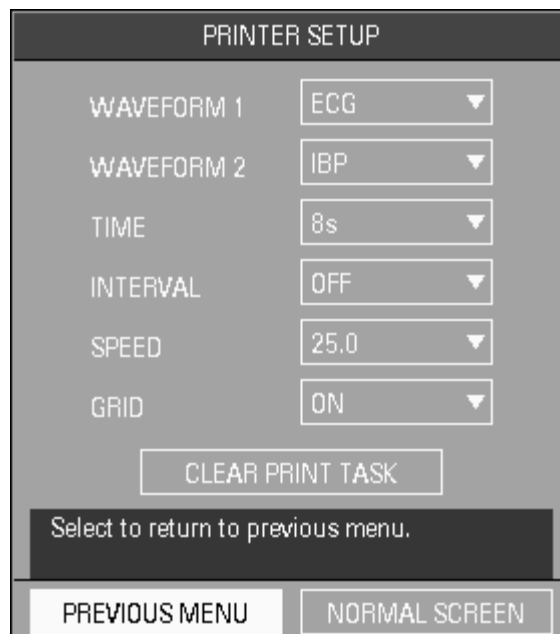

FIGURE 2-57 Printer Setup Menu

Printer Setup Menu Selections

- WAVEFORM 1:** Allows the user to designate the first of two (2) waveforms to print. If the user selects **OFF**, no waveform will print as **WAVEFORM 1**.
Selections are: **Any waveforms currently displayed** and **OFF**.
- WAVEFORM 2:** Allows the user to designate the second of two (2) waveforms to print. If the user selects **OFF**, no waveform will print as **WAVEFORM 2**.
Selections are: **Any waveforms currently displayed** and **OFF**.
- TIME:** Allows the user to select the duration of the waveform print. Selections are: **CONTINUAL** and **8s** (8 second).
- INTERVAL:** Allows the user to select the interval at which real-time printouts will automatically occur. Selections are: **OFF**, **10min**, **20min**, **30min**, **40min**, **50min**, **1HR**, **2HRS**, **3HRS**, and **4HRS**.
- SPEED:** Allows the user to select the speed at which the waveform section of the printout is output. Selections are: **25.0 mm/s** and **50.0 mm/s**.
- GRID:** Allows the user to select a print format either with or without a background grid. Selections are: **OFF** and **ON**.
- CLEAR PRINT TASK:** Allows the user to clear a print task already in progress or to clear multiple print tasks from the system.

Real-Time Print

1. Using the **PRINTER SETUP** menu, select the waveforms to print on the recorder strip. The user can designate a maximum of two (2) waveforms to print, **WAVEFORM 1** and **WAVEFORM 2**. The user may opt to set one (1) waveform to **OFF**, in which case one (1) waveform and the numeric data will print. If both waveforms are set to **OFF**, the monitor will print only the numeric data for available parameters. If no waveforms are displayed on the screen both waveforms will automatically default to **OFF** and only the numeric data for available parameters will print.
2. If the user does not designate which waveforms to print in **Printer Setup**, pressing the **PRINT** key will automatically default to printing the first two (2) waveforms displayed on the screen.
3. Select **TIME** in the **PRINTER SETUP** menu to designate the time length of the waveform printout. Select **CONTINUAL** for a continuous waveform printout. Select **8s** for an 8 second waveform printout.
4. When the print settings have been selected in the **PRINTER SETUP** menu, press the **PRINT** key on the front panel keypad to initiate a real-time printout.
5. Press the **PRINT** key again to stop a printout that is already in progress.

NOTE: **If a printout has started, and a parameter alarm prompts an additional printout, the alarm printout will not begin until the current printout is complete.**

Interval Real-Time Printout

The **Trio** can be set to print automatically at regular intervals, as designated by the user. To activate the interval print feature:

1. Select **INTERVAL** from the **PRINTER SETUP** menu.
2. Use the Navigator™ Knob to choose the interval at which an automatic printout will occur. The following time intervals are available: **10min**, **20min**, **30min**, **40min**, **50min**, **1HR**, **2HRS**, **3HRS**, and **4HRS**.
3. Select **OFF** to disable the automatic print function.

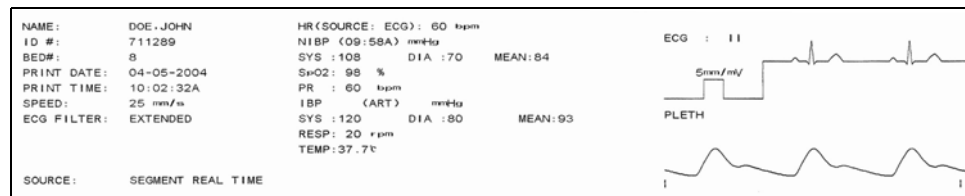

FIGURE 2-58 Example, Interval Real-Time Printout

Alarm Printout

When a parameter alarm is activated, and **ALM PRINT** is set to **ON** for the alarming parameter, a printout is automatically generated for that parameter. In the **ALARM SETUP** menu, the user can designate the length of the waveform on the alarm printout as either **8**, **16** or **32** seconds.

To set the length of the alarm printout:

1. Access the **SYSTEM MENU** using the **MENU** icon on the main display.
2. Select **MONITOR SETUP**.
3. Select **ALARM SETUP**.
4. Scroll to **ALM PRINT TIME** and select a recording time length.

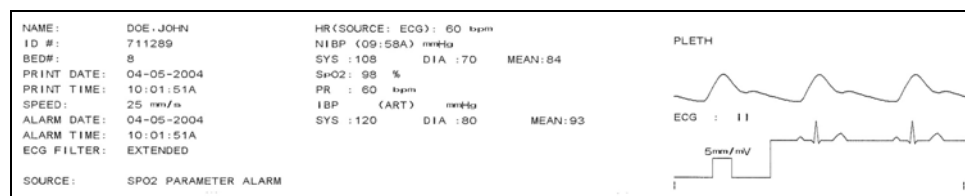

FIGURE 2-59 Example, Alarm Printout

Depending on the alarm print time selected, the print recording will display the waveform, 4, 8, or 16 seconds respectively, prior to and after the alarm event. For example, for an eight (8) second alarm printout four (4) seconds of pre-alarm, and four (4) seconds of post alarm data will appear on the printout. Alarm times of **16** or **32** seconds will print alarm data in a similar manner. All numeric data displayed during the alarm event will also be included on the printout and will print before the waveform data.

When parameter alarms occur, a maximum of two (2) waveforms can print simultaneously. If more than two (2) parameter alarms are activated simultaneously, the recorder will print out those of the highest priority level. If the alarm events are of the same priority level, the most recent alarm event will be printed. If an alarm event occurs when another alarm printout is already in progress, the more recent alarm printout will not begin until the current alarm printout is complete.

Graphic/List Trend Print

To print the graphic trend of the currently selected parameter, select **PRINT** from the **GRAPHIC TREND** menu. To stop the print job currently in progress, select **PRINT** on the front panel keypad.

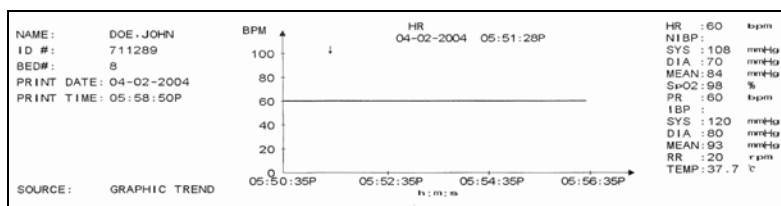

FIGURE 2-60 Example, Graphic Trend Printout

To print the list trend of all parameters, select **PRINT** from the **LIST TREND** menu. To stop the print job currently in progress, select **PRINT** on the front panel keypad.

NAME:	DOE-JOHN	TIME	EVENT	HR (BPM)	NIBP(S/D/M) (mmHg)	SpO2 (%)	PR (BPM)	RR (RPM)	TEMP (°C)
ID #:	711289	(05)10:27A		60	---	98	60	20	37.7
BED#:	8	(05)10:26A		60	108/70/84	98	60	20	37.7
PRINT DATE:	04-05-2004	(05)10:25A		60	---	98	60	20	37.7
PRINT TIME:	10:28:07A	(05)10:24A		60	---	98	60	20	37.7
		(05)10:23A		60	108/70/84	98	60	20	37.7
		(05)10:22A		60	---	98	60	20	37.7
		(05)10:21A		60	---	98	60	20	37.7
		(05)10:20A		60	---	98	60	20	37.7
		(05)10:19A		60	---	98	60	20	37.7
		(05)10:18A		60	108/70/84	98	60	20	37.7
		(05)10:17A		60	---	98	60	20	37.7
		(05)10:16A		60	---	98	60	20	37.7

FIGURE 2-61 Example, List Trend Printout

Error Log Print

To print information displayed in the **ERROR LOG** menu, select **MAINTENANCE** from the **SYSTEM MENU**. From the **MAINTENANCE** menu, select **ERROR LOG**. Select **PRINT** from the **ERROR LOG** menu. To stop the print job currently in progress, select the **PRINT** key on the front panel keypad.

NAME:	DOE-JOHN	STARTUP TIME	01-27-2004	08:59:26A
ID #:	722156	IBP SELFTEST ERROR	01-27-2004	12:14:43P
BED#:	8765-B	IBP COMM ERROR	01-27-2004	12:14:48P
PRINT DATE:	01-27-2004			
PRINT TIME:	03:12:21P			
SOURCE:	ERROR LOG			

FIGURE 2-62 Example, Error Log Printout

Clear Print Tasks

To cancel all printouts in the print queue, select **CLEAR PRINT TASK** from the **PRINTER SETUP** menu.

2.7.2 Recorder Troubleshooting

MESSAGE/ PROBLEM	REASON	SOLUTION
PRINTER HEAD HOT	The thermal terminal is too hot	Discontinue print operation. Notify hospital technician or Customer Support.
PRINT HEAD IN WRONG POS.	The thermal head is not in the proper position	Push down the lever on the left side of the internal recorder
PRINTER OUT OF PAPER	Recorder paper has been consumed or is not installed	Install a new roll of paper
PRINTER COMM ERR	Functional failure	Reset the recorder. Notify hospital technician or Customer Support
PRINTER PAPER JAM	Paper is misaligned or installed incorrectly	Remove the roll of paper and re-install
PRINTER INITIALIZING	The recorder is in the initialization process	Wait for the completion of initialization
TOO MANY PRINT TASKS	Printer has received multiple alarm print requests at one time	Check patient. Verify alarm status. Clear print tasks. Notify hospital technician or Customer Support.
PRINTER PAPER W.P.	The printer paper is in the wrong position	Remove the roll of paper and re-install
PRINTER BUSY	Printer has received multiple print requests at one time	Wait until the printer is not busy
PRINTER NOT AVAILABLE	Printer inoperable or not installed	Check printer. Notify hospital technician or Customer Support.
PRINTER VLT HIGH	The voltage of the recorder is too high	Stop recording until the recorder restores normal status. If message reappears, notify hospital technician or Customer Support.
PRINTER VLT LOW	The voltage of the recorder is too low	Stop recording until the recorder restores normal status. If message reappears, notify hospital technician or Customer Support.
PRINTER S. COMM ERR	Functional failure	Power cycle unit. If message reappears, notify hospital technician or call Customer Support.
PRINTER SELFTEST ERR	Functional failure	Power cycle unit. If message reappears, notify hospital technician or call Customer Support.
PRINTER INIT ERR 1	Functional failure	Power cycle unit. If message reappears, contact hospital technician or Customer Support.

3.1 Default Configurations

Trio has four default configurations.

- **Factory Default Configuration**
- **User Default Configuration**
- **Current Configuration**
- **Non-Volatile Configuration**

3.1.1 Factory Default Configuration

The **Factory Default Configuration** is initially set by the manufacturer. These settings cannot be changed by the user. If the user changes settings to be different from the Factory Default settings, the **Factory Default Configuration** can be restored as follows:

1. Select **RESTORE DEFAULTS** from the **MONITOR SETUP** menu. The **RESTORE DEFAULTS** menu is displayed as shown in FIGURE 3-1.

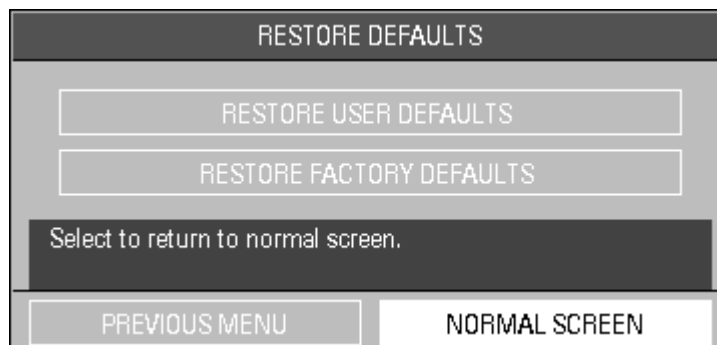

FIGURE 3-1 Restore Defaults Menu

2. Choose **RESTORE FACTORY DEFAULTS**. The confirmation dialog box in FIGURE 3-2 is displayed.
3. Select **YES** to restore the **Factory Default Configuration**. Select **NO** to cancel the task.

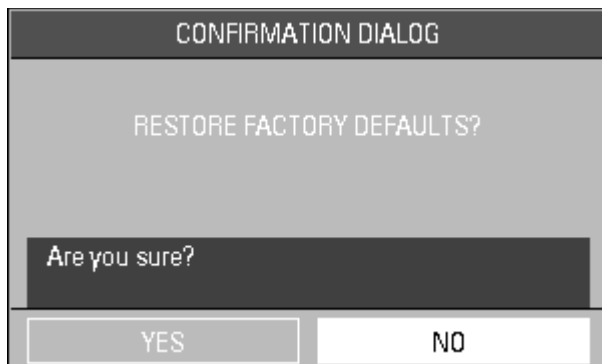

FIGURE 3-2 Confirmation Dialog Box

CAUTION: To ensure continued use of the Factory Defaults when the unit is powered off and on, save the Factory Defaults as the User Default Configuration (see section 3.1.2).

The following table provides the **Factory Default Configuration** for all of the listed items.

NOTE: The Common Factory Defaults column lists items that have the same Factory Default setting for each patient size.

NOTE: The Factory Defaults by Patient Size columns list items that have different Factory Default settings for each patient size.

CONFIGURATION ITEM	FACTORY DEFAULTS ADULT (Patient size)	FACTORY DEFAULTS PEDIATRIC (Patient size)	FACTORY DEFAULTS COMMON
GRAPHIC and LIST TREND			
Interval			1 min
MONITOR SETUP			
COMMON ALARM SETUP			
Alarm Volume			Medium
Alarm Print Time			8 Second
Alarm Mute Time			2 Minutes
PRINTER SETUP			
Print Waveform 1			ECG
Print Waveform 2			IBP (if the IBP module is installed) SpO2 (if no IBP module is installed)
Print Time (waveform length)			8 Seconds
Print Interval			OFF
Print Speed			25 mm/s

CONFIGURATION ITEM	FACTORY DEFAULTS ADULT (Patient size)	FACTORY DEFAULTS PEDIATRIC (Patient size)	FACTORY DEFAULTS COMMON
Print Grid			ON
ANALOG SETUP			
Analog Output Enable			OFF
Analog Wave			ECG
PARAMETER COLORS			
			ECG - green PLETH - blue RESP - yellow NIBP/TEMP - white
MODULE SETUP in MONITOR SETUP			
			Will be the same as MODULE SETUP submenu of the FACTORY menu.
TRACE SETUP			
			ECG, SpO ₂ , RESP, IBP (if IBP is set to display from the MODULE SETUP submenu of the FACTORY menu)
Wave Display			Mode 1
ECG SETUP			
ECG HR alarm Standard configuration French configuration			OFF ON
ECG HR Alarm Print			OFF
ECG HR Alarm Priority			1
HR Source			ECG
HR Cascade			ON
ECG Lead Type			5 Lead
ECG Sweep Speed			25 mm/s
ECG Beep Volume			Medium
ECG Pacer			OFF
ECG Filter Mode			Extended
ECG Ch1 Lead Mode			II
ECG Ch1 Gain			x2
ECG HR Alarm Limit Hi	150	175	
ECG HR Alarm Limit Lo	45	70	
RESP SETUP			
Resp Rate Alarm			OFF
Resp Rate Alarm Print			OFF
Resp Rate Alarm Priority			2
Resp Sweep Speed			12.5 mm/s
Resp Wave Scale			1
Resp Rate Alarm Limit Hi			30
Resp Rate Alarm Limit Lo			6
SPO₂ SETUP			
SpO ₂ Alarm Print			OFF
SpO ₂ Alarm Priority			2

CONFIGURATION ITEM	FACTORY DEFAULTS ADULT (Patient size)	FACTORY DEFAULTS PEDIATRIC (Patient size)	FACTORY DEFAULTS COMMON
SpO2 Sweep Speed			25 mm/s
SpO2 Beep Volume			Medium
SPO2 SENSOR OFF AUDIO			ON
SpO2 Average Time (Masimo only)			8 second
SpO2 Sensitivity Mode			Normal
Sat Seconds (Nellcor only)			OFF
SpO2 Alarm Limit Hi			OFF (for all languages)
SpO2 Alarm Limit Lo			85
Pulse Alarm Limit Hi	150	175	
Pulse Alarm Limit Lo	45	70	
NIBP SETUP			
NIBP Alarm			OFF
NIBP Alarm Print			OFF
NIBP Alarm Priority			2
NIBP Units			mmHg (for all languages)
NIBP Interval			OFF
NIBP Display Time-out			15 minutes
NIBP Sys Alarm Limit Hi	180	150	
NIBP Sys Alarm Limit Lo	80	70	
NIBP Mean Alarm Limit Hi	100	80	
NIBP Mean Alarm Limit Lo	40	30	
NIBP Dia Alarm Limit Hi	100	80	
NIBP Dia Alarm Limit Lo	50	40	
TEMP SETUP			
Temp Alarm			OFF
Temp Alarm Print			OFF
Temp Alarm Level			2
Temp Unit			°C (for all languages)
Temp T1 Alarm Limit Hi			40 °C or 104 °F
Temp T1 Alarm Limit Lo			30 °C or 86 °F
IBP SETUP			
IBP Alarm			OFF
IBP Alarm Print			OFF
IBP Alarm Priority			2
IBP Units			mmHg (for all languages)
IBP Sweep Speed			25 mm/s
IBP SCALE ADJUST			
IBP Scale ART High			150
IBP Scale PA High			100
IBP Scale CVP High			40

CONFIGURATION ITEM	FACTORY DEFAULTS ADULT (Patient size)	FACTORY DEFAULTS PEDIATRIC (Patient size)	FACTORY DEFAULTS COMMON
IBP Scale RAP High			40
IBP Scale LAP High			40
IBP Scale ICP High			40
IBP Scale ART Low			0
IBP Scale PA Low			0
IBP Scale CVP Low			0
IBP Scale RAP Low			0
IBP Scale LAP Low			0
IBP Scale ICP Low			0
IBP Scale ART Value			75
IBP Scale PA Value			50
IBP Scale CVP Value			20
IBP Scale RAP Value			20
IBP Scale LAP Value			20
IBP Scale ICP Value			20
IBP Ch1 Name			ART
IBP ART_Sys Alarm Limit Hi	180	150	
IBP ART_Sys Alarm Limit Lo	80	70	
IBP ART_Mean Alarm Limit Hi	100	80	
IBP ART_Mean Alarm Limit Lo	40	30	
IBP ART_Dia Alarm Limit Hi	100	80	
IBP ART_Dia Alarm Limit Lo	50	40	
IBP PA_Sys Alarm Limit Hi	180	150	
IBP PA_Sys Alarm Limit Lo	80	70	
IBP PA_Mean Alarm Limit Hi	100	80	
IBP PA_Mean Alarm Limit Lo	40	30	
IBP PA_Dia Alarm Limit Hi	100	80	
IBP PA_Dia Alarm Limit Lo	50	40	
IBP CVP_Mean Alarm Limit Hi			10
IBP CVP_Mean Alarm Limit Lo			0
IBP RAP_Mean Alarm Limit Hi			10
IBP RAP_Mean Alarm Limit Lo			0
IBP LAP_Mean Alarm Limit Hi			10
IBP LAP_Mean Alarm Limit Lo			0
IBP ICP_Mean Alarm Limit Hi			10
IBP ICP_Mean Alarm Limit Lo			0

3.1.2 User Default Configuration

All items listed in the preceding table can be customized by the user and saved as a unique **User Default Configuration** as follows:

1. Select **SAVE CURRENT** from the **MONITOR SETUP** menu. The confirmation dialog box in FIGURE 3-3 is displayed.
2. Select **YES** to save the new user-defined configuration, replacing the existing user-defined configuration for the current patient size. Select **NO** to cancel the task.

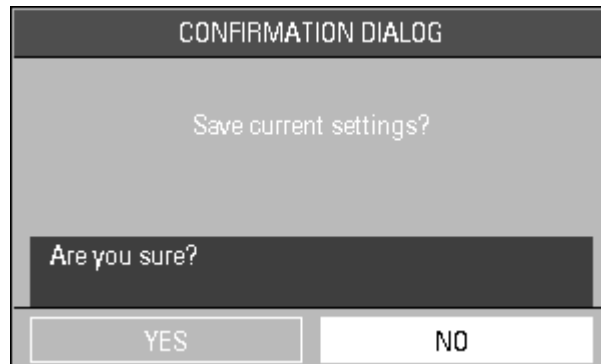

FIGURE 3-3 Confirmation Dialog Box

NOTE: At initial startup of the Trio, the User Default Configuration is identical to the Factory Default Configuration.

NOTE: Selecting a new patient size automatically activates the User Default Configuration for that patient size.

3.1.3 Current Configuration

The **Current Configuration** consists of the current settings of the items listed in the preceding table. When the monitor is powered OFF, these settings (and any trend data) are maintained for 2 hours. When the monitor remains OFF for more than 2 hours (or when a patient is discharged), any trend data is deleted. When the monitor is powered back ON (or after a patient is discharged), the **Current Configuration** is replaced by one of two configurations in the following hierarchical order:

1. The **User Default Configuration** (if it has been saved).
2. The **Factory Default Configuration** (if no **User Default Configuration** has been saved).

3.1.4 Non-Volatile Configuration

The **Non-Volatile Configuration** consists of a group of user-customizable settings that are not controlled by the Factory or User Defaults. (See the following table.) These settings are maintained when the monitor is powered OFF for any duration of time. When a patient is discharged, the items marked with an asterisk (*) in the following table are automatically cleared and will remain blank until the user re-enters information for each.

CONFIGURATION ITEM	FIRST BURN-IN VALUE
* ID #	blank/empty field
BED#	blank/empty field
* FIRST NAME	blank/empty field
* LAST NAME	blank/empty field
* GENDER	blank/empty field
SIZE	Adult
* HT. (Height)	blank/empty field
* WT. (Weight)	blank/empty field
* BIRTH (day, month, year)	blank/empty field
MODULE SETUP submenu in FACTORY menu	ECG/RESP/TEMP/SpO2/IBP/NIBP
System Time	2001-12-31 23:59:59

This page intentionally left blank.

4.1 Introduction

This section of the manual outlines routine maintenance to be performed by the user and/or biomedical technician.

The **Trio** Monitor is designed for stable operation over long periods of time and under normal circumstances should not require technical maintenance beyond circumstances described in this section. In general, routine maintenance, calibration and safety checks are recommended annually, or more often as required by local statutory or hospital administration practice.

General Maintenance Checks

Before using the monitor, do the following:

1. Check if there is any mechanical damage;
2. Check all external cables, inserted modules and accessories for damage;
3. Check all the functions of the monitor to make sure that the monitor is in good working condition.

Scheduled Maintenance Checks

1. Frequently check the device, cables, sensors and wires for damage.
2. Clean the device as needed.
3. Perform safety test annually; or once after each disassembly or repair of unit.
4. Perform all parameter checks and calibration annually or once after each repair of unit.
5. Test overall function of the device annually.

NOTE: If any damage is found on the monitor, contact the biomedical engineer of the hospital or Customer Service immediately.

4.2 Decontamination of the Monitor

WARNING: Perform the decontamination process with the unit powered down and power cord removed.

Decontamination of a unit that has come in contact with a biological material can be performed using LpH SE Germicidal detergent. Apply a small amount of detergent to a disposable wipe (paper based) and wipe down the outside of the unit. Discard the wipe appropriately. After waiting 10 minutes, use a clean dry wipe to dry the unit.

CAUTION: During the decontamination process, do not get the LpH SE Germicidal detergent into any vent openings.

4.3 Care and Cleaning of the Monitor

The monitor housing may be cleaned with a mild soap and water solution or ammoniated window cleaner. Apply cleaning solution to the cloth, not directly onto the monitor. DO NOT apply large amounts of liquid. DO NOT use abrasive cleaning agents or organic solvents.

WARNING: Do not clean the monitor or sensors while it is on and/or connected to AC power.

To prevent scratches on the screen, carefully brush dust and dirt particles with a soft sponge moistened with cleaning solution; or a fine, soft-hair brush. Fingerprints and stains may be removed by using a liquid lens cleaner and a soft cloth. DO NOT wipe a dry screen or use alcohol or a solvent containing chlorinated hydrocarbon.

4.4 Care and Cleaning of Accessories

4.4.1 SpO₂ Sensors

NOTE: Refer to the individual instruction sheets that are packaged with each sensor.

- Check the sensors and cables for signs of damage on a daily basis. Replace as required.
- The reusable sensors should be cleaned before and after each patient's use
- Wipe the patient contact area using a soft cloth with a mild soap and water solution or isopropyl alcohol. Hydrogen peroxide can be used to remove dried blood from all accessible surfaces
- The cable can be cleaned with a 3% hydrogen dioxide solution, isopropanol solution, or other active reagent. However, the connector of the sensor is not to be subjected to such a solution
- Allow the sensor to completely dry before using

CAUTION: When cleaning sensors, do not use an excessive amount of liquid. Wipe the sensor surface with a soft cloth, dampened with a cleaning solution.

CAUTION: Do not subject the sensor to autoclaving.

CAUTION: If the sensor or patient cable are damaged in any way, discontinue use immediately. To prevent damage, do not soak or immerse the sensor in any liquid solution. Do not attempt to sterilize.

CAUTION: Do not use sensors or cables that are damaged or have deteriorated.

4.4.2 Blood Pressure Cuffs

4.4.2.1 Reusable Cuffs with Bladders

Take out the bladder before cleaning and disinfecting the cuff.

Cleaning

The cuff can be hand washed or machine washed in warm water or with mild detergent. The bladder can be cleaned with a damp cloth. Air dry the cuff thoroughly after washing.

NOTE: Machine washing may shorten the service life of the cuff.

Disinfection

The cuff may be disinfected with a damp cloth with 70% ethanol or 70% isopropanol. It may also be disinfected with ultraviolet. The bladder can only be disinfected with ultraviolet.

NOTE: Prolonged use of disinfectant may cause discoloration of the cuff.

Replace the bladder after cleaning and disinfecting the cuff, as follows:

1. Place the bladder on the top of the cuff, as the figure shows.
2. Roll the bladder lengthwise and insert it into the large opening. See the figures below.
3. Hold the hose and the cuff and shake the complete cuff until the bladder is in position.
4. Thread the hose from inside the cuff, and out through the small hole under the internal flap.

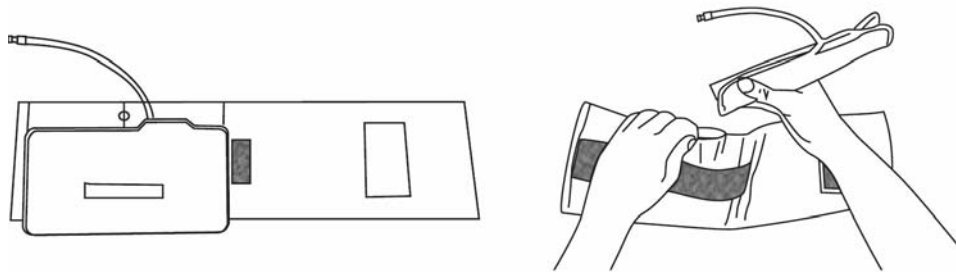

FIGURE 4-1 Cuffs with Bladders

CAUTION: Do not dry clean the cuff.
Do not press the cuff with a hot iron.
Do not use detergent and disinfectant other than fresh water, 70% ethanol or 70% isopropanol.
Clean and disinfect the cuff according to the instructions.

4.4.2.2 Reusable Bladderless Cuffs

Clean cuffs with warm water and a mild detergent. Do not use a detergent containing hard conditioners, softeners, or fragrances.

NIBP cuffs can be sterilized with gamma sterilization without effecting the repeated performance of the cuff. Steam sterilization is not recommended. Use of a washing liquid containing bleach is not recommended because chlorine will chemically break down the urethane on the inside of the cuff.

Antimicrobial Coating

Bladderless cuffs are treated with an antimicrobial coating. Antimicrobial technology effectively controls a broad spectrum of bacteria, fungi, algae and yeasts on a wide variety of treated substrates.

4.4.2.3 Disposable Blood Pressure Cuffs

Disposable cuffs are intended for single patient use only. Once a cuff is used on a patient it should be discarded. Do not use the same cuff on any other patient. Do not sterilize or use an autoclave on disposable cuffs.

NOTE: Disposable cuffs can be cleaned using a mild soap solution and dried with a clean cloth. For cuffs with bladders, remove bladder before cleaning.

4.5 Temperature Sensor Cleaning and Disinfection (Reusable)

- The temperature probe should not be heated above 100 °C (212 °F). It should only be subjected briefly to temperatures between 80 °C (176 °F) and 100 °C (212 °F)
- The probe must not be sterilized in steam
- Only detergents containing no alcohol can be used for disinfectant
- The rectal probes should be used, if possible, in conjunction with a protective rubber cover
- To clean the probe, hold the tip with one hand. With the other hand rub the probe down in the direction of the connector using a moist lint-free cloth

NOTE: Disposable temperature probe must not be re-sterilized or reused.

4.6 Battery Replacement and Maintenance

Battery Replacement

1. Open the battery compartment door located on the left side panel of the monitor by using the finger grip area and sliding the door backward.
2. Lift the release latch in the upper right corner of the battery compartment. This will release the battery. Remove the battery.
3. Insert the replacement battery, contact end first, with the positive (+) contact facing downward. Slide in the replacement battery until it latches.
4. Close battery compartment door by sliding the door forward until it firmly locks into place.

CAUTION: Replace the battery with one of the following part numbers: **0146-00-0043 (for a sealed lead acid battery), 0146-00-0069 (for a Lithium Ion battery).**

Battery Maintenance

The batteries used in the **Trio** monitor are of sealed lead acid construction and Lithium Ion construction. These types of batteries may be subject to local regulations regarding disposal. At the end of battery life, dispose of the batteries in accordance with any local regulations.

CAUTION: Remove the battery if the Trio is not likely to be used for an extended period of time.

CAUTION: Remove the battery prior to shipping the Trio.

4.7 Recorder Maintenance

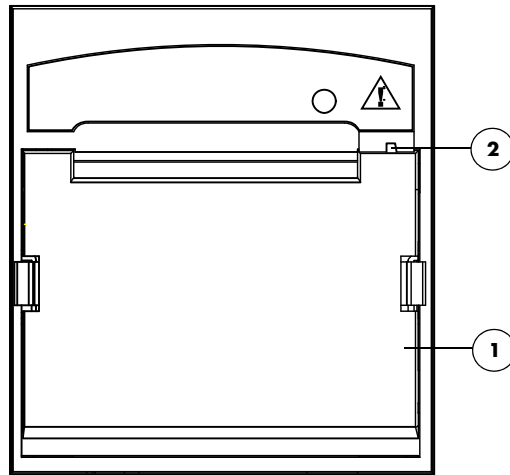

FIGURE 4-2 Two-trace, integral recorder

1. Recorder door

Open this door to access the recorder.

2. Recorder door latch

Gently pull down on this latch to open the recorder door.

4.7.1 Recorder Paper Replacement

The instructions below describe the replacement of recorder paper. Use only recommended recorder paper (Part Number 0683-00-0505-02.) This ensures that the print quality is acceptable and reduces printer head wear.

1. Open the recorder door, located on the left side panel, by pulling down on the recorder door latch, located on the upper right side of the recorder door.

NOTE: If the recorder door does not open completely, carefully pull the door until it is completely open.

2. Remove empty paper spool.
3. Lift the roller lever, located on the left side of the roller head.

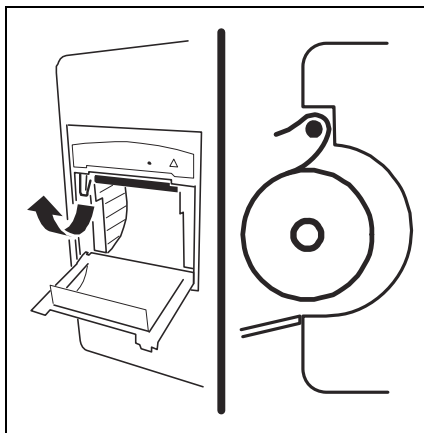

FIGURE 4-3 Paper Loading

4. Place the paper roll in the holder with the sensitive (shiny) side of the paper facing upward.
5. Unroll approximately six (6) inches of paper and fold the end of the paper to make a triangle.
6. Feed the paper behind the roller head, from below, and push paper in until the paper feeds through the roller head.
7. Pull the paper out approximately four (4) inches.
8. Roller lever must be returned to the down position before closing the recorder door. Holding the paper, close the recorder door.

4.8 Care and Storage of Thermal Paper

Thermal chart paper is chemically treated and the permanency of the printout can be affected by storage and handling conditions.

Conditions which may affect the integrity of the paper and printouts are:

- **Ultraviolet Light**
We recommend storing the printouts in a filing cabinet within a few days of printing. Long term exposure to natural or artificial UV sources may be detrimental
- **Storage Temperature and Humidity**
Keep the printouts in a cool and dry area for a longer lasting image. Extreme temperature and humidity (above 80 °F/26 °C and 80% humidity) should be avoided
- **Solvent Reactions**
Do not store the printouts in plastic bags, acetate sheet protectors and similar items made from petroleum products. These products emit a small amount of vapor which will, over a period of time, deteriorate the image on the chart paper
- **Adhesive Tape**
Never place adhesive tape over printouts. The reaction between adhesive compound and the chemical/thermal paper can destroy the image within hours
- **Archives**
We recommend that if long term archives are required, make a photocopy of the printouts as a back-up. Under normal office filing conditions the printouts should retain acceptable image quality for about five (5) years

4.9 Care and Cleaning of ECG Cables and Leadwires

The recommended cleaning method for ECG cables and leadwires is as follows:

- Wipe using a cloth and ordinary alcohol-free hand soap or USP green soap tincture
- When disinfection is required, a cloth wipe using disinfectants such as isopropyl alcohol, chlorine bleach in water (1:10 mixture) or 2% Glutaraldehyde solution (i.e. Cidex) is recommended
- After cleaning, the ECG cables and leadwires should be wiped using a clean, damp cloth. Dry the ECG cables and leadwires using a clean, dry cloth.

CAUTION: To avoid permanent damage, do not expose metal components (pins, sockets, snaps) to disinfectants, soaps or chemicals.

NOTE: ECG cables and leadwires must never be immersed, soaked in any fluids, and they should not be cleaned with harsh chemicals such as acetone or non-diluted bleach.

NOTE: Do not autoclave, radiation or steam sterilize ECG cables or leadwires.

NOTE: Extended exposure to Ethylene Oxide gas may shorten life of the ECG cables and leadwires, leading to poor signal quality.

This page intentionally left blank.

5.1 Optional Accessories

5.1.1 NIBP Accessories

Hoses

DESCRIPTION	PART NUMBERS
NIBP Hose, 5' (1.5 m), Female Rectus/Female Rectus	0683-04-0003
NIBP Hose, 10' (3.5 m), Female Rectus/Female Rectus	0683-04-0004

Color Coded Reusable Bladderless Cuffs - Quick-Connect

DESCRIPTION	PART NUMBERS
Kit, 6 cuffs, (1) small adult, (2) adult, (2) large adult, (1) thigh latex-free	0020-00-0082-33
Kit, 6 cuffs, (1) small child, (2) child, (3) small adult, latex-free	0020-00-0082-32
Large Adult, Burgundy (35.5 – 46 cm arm circumference), latex-free	0998-00-0003-55
Large Adult long, Burgundy (35.5 – 46 cm arm circumference), latex-free	0998-00-0003-58
Adult Long, Navy Blue (27.5 – 36.5 cm arm circumference), latex-free	0998-00-0003-57
Child, Green (13.8 – 21.5 cm arm circumference), latex-free	0998-00-0003-52
Small Child, Orange (9 – 14.8 cm arm circumference), latex-free	0998-00-0003-51 or 0683-15-0001-01

Color Coded Disposable Bladderless Cuffs - Quick-Connect

DESCRIPTION	PART NUMBERS
Adult Thigh, Brown (Print) (box of 5) (45 – 56.5 cm circumference), latex-free	0683-07-0036-01
Large Adult, Burgundy (Print) (box of 10) (35.5 – 46 cm arm circumference), latex-free	0683-07-0035-01
Large Adult Long, Burgundy (Print) (box of 10) (35.5 – 46 cm arm circumference), latex-free	0683-07-0038-01
Adult, Navy Blue (Print) (box of 10) (27.5 – 36.5 cm arm circumference), latex-free	0683-07-0034-01
Adult Long, Navy Blue (Print) (box of 10) (27.5 – 36.5 cm arm circumference), latex-free	0683-07-0037-01
Small Adult, Light Blue (Print) (box of 10) (20.5 – 28.5 cm arm circumference), latex-free	0683-07-0033-01
Child, Green (Print) (box of 10) (13.8 – 21.5 cm arm circumference), latex-free	0683-07-0032-01
Small Child, Orange (Print) (box of 10) (9 – 14.8 cm arm circumference), latex-free	0683-07-0031-01

Reusable Cuffs - Quick-Connect

DESCRIPTION	PART NUMBERS
Starter Kit: (1) child, (1) small adult, (1) adult, (1) large adult, (1) thigh	0020-00-0184-01
Child, 10 – 19 cm (arm circumference), latex free	0683-15-0001-01
Small Adult, 18 – 26 cm (arm circumference), latex free	0683-15-0002-01
Adult, 25 – 35 cm (arm circumference), latex free	0683-15-0003-01
Large Adult, 33 – 47 cm (arm circumference), latex free	0683-15-0004-01
Thigh, 46 – 66 cm (arm circumference), latex free	0683-15-0005-01

Disposable Cuffs - Quick-Connect

DESCRIPTION	PART NUMBERS
Child, 10 – 19 cm (arm circumference), latex free, box of 10	0683-14-0001-01
Small Adult, 18 – 26 cm (arm circumference), latex free, box of 10	0683-14-0002-01
Adult, 25 – 35 cm (arm circumference), latex free, box of 10	0683-14-0003-01
Large Adult, 33 – 47 cm (arm circumference), latex free, box of 10	0683-14-0004-01
Thigh, 46 – 66 cm (arm circumference), latex free, box of 5	0683-14-0005-01

5.1.2 Oximetry Sensors and Accessories

5.1.2.1 Pulse Oximetry-Masimo SET[®] LNOP[®] SpO₂

DESCRIPTION	PART NUMBER
LNOP [®] DCI Adult/Pediatric starter kit (one reusable adult sensor, 2 adult and 1 pediatric single patient adhesive sensors and one 12' cable)	0020-00-0130
LNOP [®] DCI-Adult reusable finger sensor (with added "flaps" for ambient light shielding and 3' cable)	0600-00-0047
LNOP [®] DCIP-Pediatric/slender digit reusable finger sensor	0600-00-0063
LNOP [®] TCI Tip Clip Ear Sensor	0600-00-0110
Ear Clip	0600-00-0086
Ear Hanger (pkg of 5)	0600-00-0087
LNOP [®] YI-Multisite reusable sensor	0600-00-0078
Multisite wrap (box of 100)	0600-00-0081
Multisite wrap, foam (pkg of 12)	0600-00-0083
LNOP [®] DCSC-Adult spot check reusable sensor	0600-00-0077
PC08-SpO ₂ cable (2.44 m./8')	0012-00-1099-01
PC12-SpO ₂ cable (3.66 m./12')	0012-00-1099-02
LNOP [®] Adt-Adult single patient adhesive sensors for patients more than 30 kgs. (pkg of 20)	0600-00-0043-01
LNOP [®] Pdt-Pediatric/slender digit single patient sensors for patients more than 10 kgs. and less than 50 kgs. (pkg of 20)	0600-00-0044-01
LNOP [®] II Inf-L-Infant L single patient adhesive sensors for patients more than 3 kgs. and less than 10 kgs. (pkg of 20)	0600-00-0100
Tape, Infant, L-Series (Package of 100)	0600-00-0108
Adult/Pediatric starter kit (two adult and two pediatric single patient adhesive sensors and one 3.66 m./12' cable)	0020-00-0123-01
Clothing clips (pkg of 5)	0600-00-0084
Adhesive squares (12 cards/12 squares per card)	0600-00-0085

5.1.2.2 Pulse Oximetry-Masimo Set[®] LNCS[®] SpO₂

DESCRIPTION	PART NUMBER
LNCS [®] Adult/Pediatric single patient adhesive sensor starter kit (one adult and one pediatric single patient adhesive sensor, and one 3.04m/10' cable)	0020-00-0156
LNCS [®] Adult/Pediatric reusable/single patient adhesive sensor starter kit (one adult reusable sensor, one adult and one pediatric single patient adhesive sensor, and one 3.04m/10' cable)	0020-00-0154
LNCS [®] DC-I Adult finger reusable sensor	0600-00-0126
LNCS [®] DC-IP Pediatric finger reusable sensor	0600-00-0127
LNCS [®] ADTX Adult single patient adhesive sensors (20/Box)	0600-00-0121
LNCS [®] PDTX Pediatric single patient adhesive sensors (20/Box)	0600-00-0122
LNCS [®] INF-L Infant single patient adhesive sensors (20/Box)	0600-00-0123
LNCS-4 SpO ₂ Patient cable, 4'	0012-00-1652

DESCRIPTION	PART NUMBER
LNC-10 SpO ₂ Patient cable, 10'	0012-00-1599
LNC-14 SpO ₂ Patient cable, 14'	0012-00-1653
LNCS [®] to LNOP [®] PC series adapter	0012-00-1651
Masimo SET MAC-1 LNCS [®] adapter cable	0012-00-1656

5.1.2.3 Nellcor[®] OxiMax[®] Cables and Accessories*

DESCRIPTION	PART NUMBER
Durasensor DS100A Adult Reusable Sensor	0600-00-0051
DOC-10 OxiMax [®] SpO ₂ cable	0012-00-1464

* Sensors must be reordered through Nellcor.

5.1.3 Reusable Temperature Probes

YSI 400

DESCRIPTION	PART NUMBERS
Adult Rectal / Esophageal	0206-02-0001
Pediatric Rectal / Esophageal	0206-02-0002
Skin Surface	0206-02-0003

5.1.4 Disposable Temperature Probes

400 Series Probes (boxes of 20)

DESCRIPTION	PART NUMBERS
Esophageal Stethoscope, 12 Fr, ES 400-12	0206-03-0112-02
Esophageal Stethoscope, 18 Fr, ES 400-18	0206-03-0118-02
Esophageal/Rectal, 9 Fr, ER 400-9	0206-03-0209-02
Esophageal/Rectal, 12 Fr, ER 400-12	0206-03-0212-02
Skin, SK 400	0206-03-0300-02
Instrument Cable, 400 Series	0012-00-0975

5.1.5 ECG Accessories

5.1.5.1 ECG Cables

DESCRIPTION	PART NUMBERS
Straight, 10' (3.1 m)	0012-00-1255-01
Straight, 20' (6.1 m)	0012-00-1255-02

5.1.5.2 ECG Leadwires

ECG Lead Wires - 3 Lead

DESCRIPTION	PART NUMBERS
3 Lead, Snap 18", AAMI (45.7 cm)	0012-00-1261-07
3 Lead, Snap 24", AAMI (61.0 cm)	0012-00-1261-08
3 Lead, Snap 40", AAMI (101.6 cm)	0012-00-1261-09
3 Lead, Pinch Clip 18", AAMI (45.7 cm)	0012-00-1262-07
3 Lead, Pinch Clip 24", AAMI (61.0 cm)	0012-00-1262-08
3 Lead, Pinch Clip 40", AAMI (101.6 cm)	0012-00-1262-09

ECG Lead Wires - 5 Lead

DESCRIPTION	PART NUMBERS
5 Lead, Snap 18", AAMI (45.7 cm)	0012-00-1261-01
5 Lead, Snap 24", AAMI (61.0 cm)	0012-00-1261-02
5 Lead, Snap 40", AAMI (101.6 cm)	0012-00-1261-03
Snap, Extended Leg, 3/40", 2/60", AAMI, (3/101.6 cm, 2/152.4 cm)	0012-00-1261-13
5 Lead, Pinch Clip 18", AAMI (45.7 cm)	0012-00-1262-01
5 Lead, Pinch Clip 24", AAMI (61.0 cm)	0012-00-1262-02
5 Lead, Pinch Clip 40", AAMI (101.6 cm)	0012-00-1262-03

5.1.5.3 Electrodes

DESCRIPTION	PART NUMBERS
Electrodes (1 box of 60)	0681-00-0100-02
Electrodes (case of 600/10 boxes of 60)	0681-00-0100-01

5.1.6 IBP Accessories

IBP

DESCRIPTIONS	PART NUMBERS
P10EZ-1 Miniature (Reusable)	0682-00-0085
P23XL-1 Transducer (Reusable)	0682-00-0084
Cable, Interface, Transducer	0012-00-1245

5.1.7 Miscellaneous Accessories

DESCRIPTIONS	PART NUMBER
DIAP Cable Assembly 10'	0012-00-1275-01
Recorder Chart Paper (12 Rolls)	0683-00-0505-02
Battery, Sealed Lead Acid	0146-00-0043

DESCRIPTIONS	PART NUMBER
Battery, Lithium Ion	0146-00-0069
AC Power Cord, (110 Volt)	0012-25-0001

5.1.8 Mounting Kits and Accessories

DESCRIPTIONS	PART NUMBER
Trio Rolling Stand Kit (includes Rolling Stand and Mounting Bracket)	TRIOROLLSTD
Trio Value Rolling Stand	0436-00-0224-01
Trio Value Rolling Stand Mounting Bracket	0406-00-0856-01
Trio Standard Wall Mount Kit	0040-00-0337-01
Trio VHM (Variable Height Mount) Wall Mount Kit	0040-00-0337-02
Trio Mounting Bracket Kit	0040-00-0338

5.1.9 Replacement Parts, Trio Rolling Stand

DESCRIPTIONS	PART NUMBER
Trio Monitor Mounting Kit	0406-00-0856-01
Casters, Non Locking	0401-00-0045
Casters, Locking	0401-00-0046
Utility Basket	0202-00-0166

6.0 *Appendix*

6.1 Specifications

6.1.1 Safety Standards

IEC 60601-1:1988 (+ A1:1991, A2:1995)/ EN 60601-1:1990 (+ A1:1993, A2:1995, A13:1995)	Medical Electrical Equipment - Part 2, General Requirements for Safety
UL 2601-1:1997	Medical Electrical Equipment - General Requirements for Safety
CSA Standard C22.2 No. 601.1M90	Medical Electrical Equipment - General Requirements for Safety
IEC 60601-1-4:2000/ EN60601-1-4:1996 (+A1:1999)	Collateral Standard: Programmable Electrical Medical Systems
IEC 60601-2-30:1999/ EN 60601-2-30:2000	Particular requirements for the Safety of Automatic Cycling Indirect Blood Pressure Measuring Equipment
IEC 60601-2-34:2000/ EN 60601-2-34:2000	Particular Requirements for the Safety of Direct Blood Pressure Monitoring Equipment
IEC 60601-2-27:1994/ EN 60601-2-27:1994	Particular Requirements for the Safety of Electrocardiograph Monitoring Equipment

EN 12470-4:2000	Clinical thermometers - Part 4: Performance of Electrical Thermometers for Continuous Measurement
EN 1441:1997	Medical Devices - Risk Analysis
EN ISO14971:2000	Medical Devices-Application of Risk Management Analysis to Medical Devices

6.1.2 Safety Designations

Type of protection against electric shock	-Class 1 with internal electric power source. Where the integrity of the external protective earth (ground) in the installation or its conductors is in doubt, the equipment will be operated from its internal electric power source (batteries).
Degree of protection against electric shock:	- ECG and IBP - Type CF defibrillation protected - NIBP - Type BF defibrillation protected - SpO ₂ and Temperature - Type BF - Monitor - Type B
Supply Connection:	100 – 240 Volt 50 or 60 Hz 0.8 – 0.4 Amps 12 VDC Sealed Lead Acid Internal Battery or 11.1 VDC Lithium Ion Internal Battery
Mode of Operation:	Continuous
Protection Against Hazards of Explosion:	Not protected (Ordinary)
Protection Against Ingress of Liquid's	Not protected (Ordinary) - IPX0 per IEC 529
Degree of electrical connection between equipment and patient -	Equipment designed for direct electrical and non-electrical connection to the patient
Degree of Mobility:	Transportable

6.1.3 Performance / Accuracy

EN 865:1997	Pulse Oximeters - Particular Requirements
EN 1060-1:1995	Specification for Non-invasive Sphygmomanometers
EN 1060-3:1997	Non-invasive Sphygmomanometers, Supplementary Requirements for Electromechanical Blood Pressure Measuring Systems
ANSI/AAMI EC13:2002	Cardiac Monitors, Heart rate Meters, and Alarms
ISO 3744:1994	Acoustics - Determination of Sound Power Levels of Noise Sources Using Sound Pressure
ANSI/AAMI/ISO 10993-1:1997	Biological evaluation of medical devices - Part 1: Evaluation and Testing
ANSI/AAMI SP-10:1992	Electronic or Automated Sphygmomanometers
EN475:1995	Medical Devices, Electrically-generated Alarm Signals
EN 1041:1998	Information Supplied by the Manufacturer with Medical Systems
EN 980:1996 + A1:1999 + A2:2001	Graphical Symbols for Use in Labeling of Medical Devices
IEC 878:1998	Graphical Symbols for Electrical Equipment in Medical Practice
ISO 1000:1992 + A1:1998	SI units and recommendations for the use of their multiples and of certain other units

6.1.4 Environmental / EMC

IEC 60601-1-2:2001/	Medical Electrical Equipment - Part 1-2: EN 60601-1-2:2001 General Requirements for Safety: EMC Requirements and Tests
IEC 68-2-6:(1982) and A1(1983) and A2(1985)	Basic Environmental Test Procedures Part 2: Vibration
IEC 68-2-27:1987	Basic Environmental Test Procedures Part 2: Shock
IEC 68-2-37:1973 & A1:1983	Basic Environmental Test Procedures Part 2: Random Vibration - Wide Band
IEC 529:1989	Degrees of Protection Provided by Enclosures (IP Code)
ISTA: 1998 Procedure 1A	Pre-Shipment Test Procedures
ECRI PB-296892:1979 (for Drop and Impact requirements)	Development of Environmental Test Methods for Non-Implantable Devices (Class 3 device)

6.1.5 United States Food and Drug Administration Documents

Reviewer Guidance for Pre-market Notification Submission, November 1993 - draft Guidance

Non-Invasive Blood Pressure (NIBP) Monitor Guidance, March 10, 1997

Non-Invasive Pulse Oximeter General Guidance, draft, September 7, 1992

Cardiac Monitor Guidance (Including Cardiotachometer and Rate Alarm), November 5, 1998

6.2 Patient Parameter Specifications

6.2.1 ECG

6.2.1.1 ECG Safety Requirements

The 3/5 Lead ECG function is in accordance with the applicable requirements of EN 60601-2-27.

6.2.2 ECG Performance Requirements

Lead Definition:

ECG TYPE	ACQUIRED LEADS	DISPLAYABLE LEADS
3-Lead ECG	I, II, III	I, II, III (one vector at a time)
5-Lead ECG	I, II, and V (n)	I, II, III, aVR, aVL, aVF, V (n) (one vector at a time)

Lead Fault: Lead resistances $\leq 51 \text{ k}\Omega$ in parallel with $0.047 \text{ }\mu\text{F}$ capacitance will not cause a lead fault condition.

Differential offsets $\leq 300 \text{ mV}$ will not cause a lead fault condition.

3/5 Lead ECG Cable Selection: Manually Selected.

Gain selection: $\times 0.25, \times 0.5, \times 1, \times 2 \text{ (mm/mV)}$

Sweep Speed: $12.5 \text{ mm/s}, 25 \text{ mm/s}, 50 \text{ mm/s}$

Input Bias Current: $< 1 \text{ }\mu\text{A}$

Frequency Response:

BANDWIDTH (-3 dB)		
MONITOR MODE	EXTENDED MODE	SURGICAL MODE
0.5 to 40 Hz	0.05 to 100 Hz	1 to 20 Hz

Common Mode Rejection:

MONITOR MODE	EXTENDED MODE	SURGICAL MODE
$> 105 \text{ dB}$	$> 90 \text{ dB}$	$> 105 \text{ dB}$

Electrical Surgical Unit (ESU) Use:

Protection:	3 and 5 Lead ECG meets ANSI/AAMI EC13 requirements for functionality following ESU energy exposure. The system is capable of withstanding ESU stress with no permanent damage and regain normal function within 10 seconds after removal of the disturbance.
Withstand:	3 and 5-Lead ECG will withstand ESU stress from a High Frequency Surgical Unit operating at 300 Watts in cut mode and 100 Watts on coagulate mode.
Noise Suppression:	3 and 5-Lead ECG peak noise is less than + 2 mV from ECG baseline when used with AAMI compatible cables.
ECG Filters:	
ESU Interference Filtering:	An ESU Interference filter will provide greater than 90 dB attenuation at 500 kHz. The ESU Filter is turned ON by selecting SURGICAL mode and OFF by selecting either MONITOR or EXTENDED modes.
50/60 Hz Notch Filtering:	A Notch Filter is provided from 50 to 60 Hz. The Notch Filter is ON when in MONITOR or SURGICAL modes and OFF when in EXTENDED mode.
Pacemaker Pulse Display:	
Rejection:	Pacer signals from ± 2 mV to ± 700 mV (RTI) amplitude and 0.1 ms to 2 ms in duration, and a maximum of 100 μ s rise time are rejected from the display when the Pacer Rejection Mode is ON.
Enhancement:	Pacer signals within the range ± 6 mV and ± 700 mV (RTI) amplitude with a maximum rise time of 100 μ s and with duration in the 0.1 ms to 2.0 ms range are enhanced on the display when the Pacer Enhancement Mode is turned ON.

6.2.3 ANSI/AAMI EC13-2002 Compliance

The ECG meets the section 4.2 Performance Requirements of ANSI/AAMI EC13-2002 except for paragraph 4.2.9.13, Synchronizing Pulse for Cardioversion, which is not applicable.

6.2.3.1 Disclosed Performance Specifications

Tall T-Wave Rejection:	When tested in accordance with ANSI/AAMI EC13-2002 section 4.1.2.1 c), the heart rate meter will reject all T-waves with amplitudes less than 120% of a 1 mV, 100 ms QRS, and a T wave duration of 180 ms and a Q-T interval of 350 ms.
Heart Rate Averaging:	ANSI/AAMI EC13-2002 section 4.1.2.1 d). The Heart Rate Averaging computation is as follows: The average of the last 4 R-to-R intervals, when last 3 R-to-R intervals > 1200 ms. Otherwise, the average of the last 12 R-to-R intervals, minus the maximum and minimum values. The update rate of the Heart Rate on the display is once per second.
Heart Rate Meter Accuracy and Response to Irregular Rhythm:	When tested in accordance with ANSI/AAMI EC13-2002 section 4.1.2.1 e), the indicated heart rate after a 20 second stabilization period is: Figure 3a (Ventricular Bigeminy) - 80 bpm Figure 3b (Slow Alternating Ventricular Bigeminy) - 60 bpm Figure 3c (Rapid Alternating Ventricular Bigeminy) - 120 bpm Figure 3d (Bi-directional Systoles) - 90 bpm

Step Change Response Time:	<p>When tested in accordance with ANSI/AAMI EC13-2002 section 4.1.2.1f), the response time of the heart rate meter to changes in heart rate is:</p> <p>Less than 7 sec for step increase from 80 to 120 bpm Less than 8 sec for step decrease from 80 to 40 bpm</p>
Time to Alarm for Tachycardia:	<p>When tested in accordance with ANSI/AAMI EC13-2002 section 4.1.2.1g), the time to alarm is:</p> <p>For Figure 4a - < 8 seconds For Figure 4b - < 8 seconds</p>
Pacer Rejection:	<p>When tested in accordance with ANSI/AAMI EC13-2002 section 4.1.4.1, the heart rate meter will reject all pulses of amplitude ± 2 mV to ± 700 mV and duration 0.1 ms to 2 ms with no tail.</p> <p>When tested in accordance with ANSI/AAMI EC13-2002 section 4.1.4.2, the heart rate meter will reject all pulses of amplitude ± 2 mV to ± 700 mV and duration 0.1 ms to 2 ms with 100 ms time constant tail of less than 2.0 mV, or 4 ms time constant tail of less than 2.0 mV.</p> <p>When tested in accordance with ANSI/AAMI EC13-2002 section 4.1.4.3, the minimum input slew rate that will cause approximately 50% of Figure 5d's pulses to trigger the Trio's pacer pulse detector is 10 V/s RTI.</p>

6.2.4 ECG Systole Detector and Heart Rate Meter

The ECG heart rate meter function is derived from the ECG waveform. It provides a "count" of the number of "R" waves per minute that are detected in the ECG waveform.

6.2.4.1 ECG Derived Heart Rate Meter Performance Requirements

Range:

ECG SOURCE	PEDIATRIC RANGE (bpm)	ADULT RANGE (bpm)
3/5 Lead ECG	15 to 350	15 to 300

Resolution:	1 bpm
Accuracy:	± 1 bpm or $\pm 1\%$ whichever is greater.
Trigger Threshold Level:	200 μ V (Lead II)
Trigger Indication:	There is an audible beep on every beat captured

6.2.5 ECG Respiration Performance Requirements

Sensing Leads:	Lead II
Source:	3-lead or 5-lead ECG Cable.
Range:	Adult: 6 to 120 breaths per minute Pediatric: 6 to 150 breaths per minute
Accuracy:	$\pm 2\%$ or ± 2 breaths per minute, whichever is greater
Excitation:	≤ 300 μ A RMS max.
Bandwidth:	0.2 Hz to 2 Hz (-3 dB) for all patient sizes
Baseline Impedance Range:	200 Ω to 2500 Ω at patient with 1 k Ω resistor in the ECG cable.
Linear Signal Range:	3 Ω -p-p minimum
Noise:	less than 0.05 Ω at 500 Ω patient impedance, using a standard ECG cable
Min. Breath Height Detected:	Function of respiration scale. Waveform needs to be greater than 0.3 Ω in order for breaths to be accurately detected.
Cardiovascular Artifact Rejection:	Detected by algorithm
Sweep speed:	6.25 mm/s, 12.5 mm/s, 25 mm/s

6.2.6 NIBP Sub-System Performance Characteristics

The NIBP function is capable of providing systolic, diastolic, and mean blood pressure measurements in Pediatric and Adult modes non-invasively, using a blood pressure cuff. It operates over the pulse rate range of 40 to 240 bpm.

The NIBP function is in accordance with the requirements of EN 60601-2-30, EN 1060-1, EN 1060-3 and ANSI/AAMI SP-10:1992.

6.2.6.1 Systolic Pressure Measurement

Accuracy*: Mean error is less than ± 5 mmHg, Standard Deviation is less than ± 8 mmHg

Range:	ADULT MODE	PEDIATRIC MODE
	40 to 255 mmHg	40 to 200 mmHg

6.2.6.2 Diastolic Pressure Measurement

Accuracy*: Mean error is less than ± 5 mmHg, Standard Deviation is less than ± 8 mmHg

Range:	ADULT MODE	PEDIATRIC MODE
	10 to 210 mmHg	10 to 150 mmHg

*Adult and Pediatric

Blood pressure measurements determined with this device are equivalent to those obtained by a trained observer using the cuff/stethoscope auscultation method, within the limits prescribed by ANSI/AAMI SP-10:1992, *Electronic or automated sphygmomanometers*.

NOTE: **Mean Arterial Pressure (MAP) is defined as:**
Mean Pressure 1 = Mean Pressure determined from the oscillometric profile
Mean Pressure 2 = (2*diastolic + systolic) / 3
Mean Pressure Displayed = (Mean Pressure 1 + Mean Pressure 2) / 2

6.2.6.3 Static Pressure Measurement

Range: 0 – 325 mmHg

Static Accuracy: ± 3 mmHg over the entire range.

6.2.6.4 Heart Rate from NIBP

Accuracy: ± 2 bpm or 2%, whichever is greater

Resolution: 1 bpm

Range:	ADULT MODE	PEDIATRIC MODE
	40 to 240 bpm	40 to 240 bpm

6.2.6.5 NIBP Sub-System Functional Requirements

Maximum Cuff Pressure

The software controlled over pressure monitor will vent to atmosphere if the following cuff pressures are detected:

ADULT MODE	PEDIATRIC MODE
≥ 300 mmHg	≥ 243 mmHg

Under single-fault conditions, the hardware controlled over pressure mechanism will vent the cuff to atmosphere so that the pressure in the cuff does not exceed the following:

ADULT MODE	PEDIATRIC MODE
300 (+10%) mmHg	300 (+10%) mmHg

Cuff Inflation

The inflation source is capable of supplying sufficient air to bring a volume of 500 cc's to a pressure of 300 mmHg in no more than 20 seconds.

If the cuff is not inflated 5 mmHg within 18 seconds then the cuff is vented and the measurement is stopped.

Maximum Leakage

The maximum allowed pressure drop with the bleed valves closed is 6 mmHg in 60 seconds as measured with a 500 cc volume at differential pressures of 250 mmHg, 150 mmHg and 50 mmHg.

Vent Rate

A volume of 500 cc, when vented, is reduced from a pressure of 260 mmHg to a pressure of 15 mmHg in a maximum of 10 seconds.

Initial Conditions

An NIBP Zero is performed automatically before the NIBP can be initiated.

An NIBP measurement will not initiate until the unit has been powered ON for 5 seconds in order to allow time for the Zero.

NIBP Start Pressure Settings and Ranges

The Start Pressure is automatically adjusted based on the selected patient size and is set to the following defaults:

PATIENT SIZE	PRESSURE INCREMENT (DEPENDING ON ALGORITHM)	DEFAULT START PRESSURE
Adult Mode	30 – 60 mmHg	178 ±5 mmHg
Pediatric Mode	30 – 60 mmHg	133 ±5 mmHg

NIBP Measurement Cycle

There are two different modes of measurement operation: manual and interval modes. The manual mode requires the operator to initiate the measurement cycle. The interval mode follows a configured plan of automatically initiated measurement cycles.

The Maximum Measurement Cycle Duration is 180 seconds for Adult and Pediatric patients.

In interval mode and manual mode, the unit adjusts the inflation pressure according to the previous systolic pressure. After the first successful measurement is made, the subsequent inflation pressure becomes $+50 \pm 10$ mmHg above the previous systolic pressure measurement.

6.2.7 IBP Parameter Sub-System Performance Characteristics

The **Trio** monitor is capable of providing invasive blood pressure (IBP) measurements from a maximum of 1 IBP channel.

The IBP channel will provide three pressure readings: systolic, diastolic, and mean pressures.

6.2.8 IBP Safety Requirements

The IBP function meets the safety requirements of EN 60601-2-34.

6.2.8.1 IBP Performance Requirements

Accuracy:	± 1 mmHg or 2% which ever is greater (excluding transducer error)
Excitation:	5 Volts DC, +/-2% Minimum load resistance is 300 ohms per transducer.
Transfer Function:	Is compatible with 5 μ V/mmHg/Volt nominal excitation transducers. Impedance range 300 – 3000 Ω .
Zero Offset Range:	The transducer zero offset range is ± 200 mmHg.
Zero Accuracy:	The zero accuracy is ± 1 mmHg.
Linear Input Range:	-50 to +300 mmHg, after zeroing.
Noise:	<0.5 mmHg RTI, DC to 15 Hz, 300 Ω source impedance.
Drift:	<0.15 mmHg per degree Celsius. ± 1 mmHg over 24 hours.
Frequency Response:	DC to 16 Hz +/- 1 Hz, -3 dB
Resolution:	1 mmHg

6.2.9 Temperature Parameter Performance Characteristics

The **Trio** monitor is capable of providing temperature measurements from a single temperature channel as measured from a YSI 400 probe and meets the requirements of EN12470-4:2000.

6.2.9.1 Temperature Performance Requirements

Scale:	selectable Celsius or Fahrenheit
Range:	0 °C to 50 °C 32 °F to 122 °F
Resolution:	0.1 °C 0.1 °F
Accuracy:	± 0.1 °C (0 °C to 50 °C), exclusive of probe errors ± 0.2 °F (32 °F to 122 °F), exclusive of probe errors
Accuracy inclusive of 400 Series probes:	± 0.2 °C (32 °C – 42 °C) ± 0.3 °C (otherwise) ± 0.4 °F (90 °F – 108 °F) ± 0.6 °F (otherwise)
Probe Excitation: 400 Series:	<100 µA, tip to sleeve.

6.2.10 SpO₂ Performance Requirements

The **Trio** monitor is capable of providing SpO₂ functional saturation level measurements via a Masimo SET[®] MS-7 pulse oximeter, a Nellcor[®] MP506 or a Nellcor[®] Nell-3 pulse oximeter.

6.2.10.1 Agency Requirements:

The SpO₂ function is in accordance with the requirements of EN 865: 1997.

6.2.10.2 Masimo SET[®] SpO₂ Performance Requirements

The Masimo SET MS-7 pulse-oximeter with SET technology is implemented.

Sensor Compatibility: LNOP[®] or LNCS[®] Series

SpO₂ Display Range: 1 – 100%

SpO₂ Resolution: 1%

SpO₂ Accuracy

No motion conditions^{1,4}:

PATIENT SIZE	SATURATION RANGE	
	70% to 100%	0 – 69%
Adult Mode	± 2 digits	unspecified
Pediatric Mode	± 2 digits	unspecified

During motion conditions^{2,5}:

PATIENT SIZE	SATURATION RANGE	
	70% to 100%	0 – 69%
Adult Mode	± 3 digits	unspecified
Pediatric Mode	± 3 digits	unspecified

SpO₂ Response Time

20 seconds maximum to 95% of final step change of % SpO₂ value from 60 to 95% at 75 bpm. Post averaging time is set at 8 seconds

Low Perfusion Performance³

LOW PERFUSION CONDITIONS			
PULSE AMPLITUDE	% TRANSMISSION	SATURATION ACCURACY	PULSE RATE ACCURACY
> 0.02%	> 5%	± 2 DIGITS	± 3 DIGITS
LNOP TC-I		± 4 digits	± 3 digits
LNOP Y-I		N/A	N/A

Masimo SET SpO₂ Pulse Rate Performance Requirements

Pulse Rate Resolution: 1 bpm

Pulse Rate Range and Accuracy

PATIENT SIZE	PULSE RATE RANGE	ACCURACY	
		NO MOTION CONDITIONS ¹	DURING MOTION CONDITIONS ²
Adult/Pediatric	25 to 240 bpm	± 3 digits	± 5 digits

Update Rate

Update rate is 1 Hz.

Masimo SET[®] Reference Footnotes

¹The Masimo SET MS-7 pulse oximeter with LNOP or LNCS sensors has been validated for no motion accuracy in human blood studies on healthy adult volunteers in induced hypoxia studies in the range of 70% to 100% SpO₂ against a laboratory co-oximeter and ECG monitor. This variation equals plus or minus one standard deviation. Plus or minus one standard deviation encompasses 68% of the population.

²The Masimo SET MS-7 pulse oximeter with LNOP or LNCS sensors has been validated for motion accuracy in human blood studies on healthy adult volunteers in induced hypoxia studies while performing rubbing and tapping motions at 2 to 4 Hz. At an amplitude of 1 to 2 cm and non-repetitive motion between 1 to 5 Hz. At an amplitude of 2 to 3 cm in induced hypoxia studies in the range of 70% to 100% SpO₂ against a laboratory co-oximeter and ECG monitor. This variation equals plus or minus one standard deviation. Plus or minus one standard deviation encompasses 68% of the population.

³The Masimo SET MS-7 pulse oximeter has been validated for low perfusion accuracy in bench top testing against a Biotek Index 2 simulator and Masimo's simulator with signal strengths of greater than 0.02% and a % transmission of greater than 5% for saturations ranging from 70 to 100%. This variation equals plus or minus one standard deviation. Plus or minus one standard deviation encompasses 68% of the population.

⁴The LNOP Ear sensor has an SpO₂ accuracy (including low perfusion) of 70% to 100% ±3.5% for adults during no motion conditions, however, since the monitor can not display 1/2 digits, the accuracy is rounded to ±4 digits.

⁵The SpO₂ accuracy during motion conditions is not specified for the LNOP Ear sensor.

NOTE: **The sensor measurement wavelengths are nominally 660 nm for the red LED and 940 nm for the infrared LED. Maximum optical power output for LED is 4 mW.**

6.2.10.3 Nellcor[®] SpO₂ Performance Requirements

Sensor Compatibility: OxiMax series MAX-A, MAX-AL, MAX-N, MAX-P, MAX-I, MAX-FAST, MAX-R, OxiCliq A, OxiCliq N, OxiCliq P, OxiCliq I, D-YS, D-YSE, D-YSPD, DS-100A, OXI-A/N and OXI-P/I.

SpO₂ Display Range: 1 – 100%

SpO₂ Resolution: 1%

Saturation Accuracy

SENSOR	ACCURACY
MAX-A, MAX-AL, MAX-N, MAX-P, MAX-I and MAX-FAST	70% to 100% ± 2 digits Below 70% unspecified
OxiCliq A, OxiCliq N, OxiCliq P and OxiCliq I	70% to 100% ± 2.5 digits Below 70% unspecified
D-YS, DS-100A, OXI-A/N and OXI-P/I	70% to 100% ± 3 digits Below 70% unspecified
MAX-R, D-YSE and D-YSPD	70% to 100% ± 3.5 digits Below 70% unspecified

Nellcor[®] SpO₂ Pulse Rate Performance Requirements

Pulse Rate Range and Accuracy

RANGE	ACCURACY
20 to 250 bpm	±3 bpm
251 to 300 bpm	Unspecified

Update Rate

Update rate is 1 Hz.

NOTE: The sensor measurement wavelengths are nominally 660 nm for the red LED and 890 nm for the infrared LED. Maximum optical power output for LED is 4 mW.

6.3 Physical Specifications

6.3.1 Information Display and Control

6.3.1.1 Front Panel Display

DISPLAY TYPE	SIZE	MINIMUM RESOLUTION
Color active matrix TFT liquid crystal	8.4-inch diagonal	800 x 600 pixels

6.3.1.2 Rotary Knob (Navigator™)

The rotary knob is a 16-position per revolution encoder with an integral push button switch

6.3.2 LED Indicators

6.3.2.1 Alarm Indicators

Visual alarm indicators are in accordance with EN475: 1995

The Alarm Indicator is a top mounted, bi-color LED with a clear, frosted lens.

A red LED will flash at 1.4 – 2.8 Hz (84 times/minute) at 50% duty cycle during a warning alarm (high priority).

A yellow LED will flash at a rate of 0.4 – 0.8 Hz at a 50% duty cycle during a caution alarm (medium priority).

If a warning and caution alarm are in force simultaneously, only the red LED is activated.

Power Indicators

A green "AC Mains" LED is illuminated whenever the unit is connected to AC Power.

A green "Battery Charging" LED that is illuminated when AC power is present and the battery is installed and charging. When the monitor is running on battery power, this LED does not illuminate. When a "low battery" condition exists, this LED flashes at a constant rate.

6.3.2.2 Keypad

A micro-switch keypad with provisions for 5 keys is provided. Key functions include: power ON/standby key, NIBP start/stop key, PRINT start/stop key, ALARM MUTE key and NORMAL SCREEN key.

6.3.2.3 Audio Indicators

An audio speaker is provided to annunciate alarms, message tones and systole beep tones. Audio alarms are in accordance with EN475: 1995

6.3.3 Real Time Clock

The Display Resolution for the Real Time Clock is: 1 second

The Accuracy of the Real Time Clock is: ± 1 minute/month (30 days) @ 21 °C ± 3 °C

Clock display format: 12 hr or 24 hr (user selectable)

The Real Time Clock has a dedicated independent power source that allows it to keep time whether or not the **Trio** monitor has power provided.

6.3.4 Input/Output Communications

6.3.4.1 Analog Output

Meets the requirements of EN60601-1 for short-circuit protection and leakage current.

6.3.4.2 ECG Analog Output Specification

Bandwidth (-3 dB referenced to 10 Hz): Same as ECG Filter Setting

Maximum Propagation Delay (Delay of QRS complex): 25 ms

Sensitivity (referenced to 10 Hz): 1 V/mV of input, $\pm 10\%$

Pacer Rejection/Enhancement: There is no pacer rejection or enhancement in the ECG analog output.

Arterial Blood Pressure Analog Output Specification

Bandwidth (-3 dB referenced to 10 Hz): DC to 15 Hz minimum

Maximum Propagation Delay: 25 ms (without sensor, measured using a simulator as the input)

Sensitivity: 1 V/100 mmHg, $\pm 10\%$

6.3.4.3 DIAP Communication Protocol (model number 0998-00-0600-4XXXX)

Trio Monitors bearing a model number of 0998-00-0600-4XXXX support the proprietary communication protocol DIAP (0070-00-0307) with the following exceptions:

1. The NIBP elapsed time is set to “—” when the elapsed time is greater than 999 minutes.
2. Though not specified in the protocol, the alarm limit values are at the same resolution as the parameter value. Example, temperature is 10X; therefore, the alarm limit values are also 10X.

6.3.4.4 VGA Output (model numbers 0998-00-0600-0XXXX and 0998-00-0600-2XXXX)

Trio Monitors bearing model numbers 0998-00-0600-0XXXX or 0998-00-0600-2XXXX are equipped with a 15-position D-Shell VGA output connector. The VGA output connector provides connectivity to a medical grade remote repeater display. Connection to this port shall be made with the monitor power OFF. The monitor shall be powered ON after powering ON the remote display.

Working mode: 640X480 resolution, 16-color, APA mode

Signal: Analog RGB - 0.7 Vpp/750 ohm, Horizontal/Vertical - TTL Positive/Negative

Connector type: 15-position D-subminiature receptacle

6.3.4.5 Ethernet

The **Trio** monitor has a standard Ethernet port for downloading software upgrades.

Connector type: RJ-45

6.3.5 Power Supply

6.3.5.1 Power Source

The **Trio** monitor will auto-select its power source from those available. The monitor uses the following priority in choosing the power source:

1. AC Mains Power
2. Internal battery power

The monitor will operate from AC Mains power with or without the internal battery installed.

6.3.6 AC Mains Power Source

Input Voltage: 100 – 240 VAC (+/-10%)

Line Frequency: 50 or 60 Hz (+/-3 Hz)

Current: 0.8 – 0.4 Amps

6.3.7 Battery Power

The maximum number of installed batteries: 1

Time to Shutdown from Low Battery: >10 minutes but < 20 minutes after indication, with 1 new, fully charged battery.

6.3.7.1 Sealed Lead Acid Battery: P/N 0146-00-0043

The minimum Battery Run Time is: 75 minutes from one fully charged new battery at 25 °C for the following conditions, which represent the most likely transportable configuration: ECG, SpO₂, and NIBP running at the 15 minute interval.

The Battery Recharge Time is: 8 hours maximum

6.3.7.2 Lithium Ion Battery: P/N 0146-00-0069

The minimum Battery Run Time is: 3.25 hours from one fully charged new battery at 25 °C for the following conditions, which represent the most likely transportable configuration: ECG, SpO₂, and NIBP running at the 15 minute interval.

The Battery Recharge Time is: 6.5 hours maximum

6.3.8 Data Storage

6.3.8.1 Monitor Configuration Data Storage

The monitor has the ability to store, in non-volatile memory, the user selectable configuration. In addition to the factory default configuration for each patient size, there is 1 user configurable configuration available for each patient size and the following information is saved:

- Alarm Values
- Display Configurations
- NIBP Interval
- Parameter Settings, scaling
- Trace Speed
- Printer Settings
- Trend Configurations

6.3.8.2 Patient Data Storage

The current patient information and demographics are stored in non-volatile memory.

6.3.8.3 Patient Trend Data

The monitor is capable of storing a maximum of 24 hours of list and/or graphic trend values for each active parameter. The minimum time interval for list trends is one minute. The minimum interval for graphic trends is 1 second. When the monitor is powered OFF, the list and graphic trend data is maintained for 2 hours. If the monitor remains OFF for more than 2 hours, the list and graphic trend data is deleted.

6.3.9 Printers

6.3.9.1 Integrated Thermal Printer

The integrated printer is a maximum 2- trace thermal array strip chart printer.

The printer uses plain white thermal paper 50.0 ± 0.1 mm wide.

The printer supports 2 paper speeds: 25 and 50 mm/sec.

The printer scaling is ± 5% of the scale set on the display for a single trace, and 50% of scale set on the display for dual trace, ± 5%.

The printer has 6 modes: manual, on alarm, on interval, frozen waveforms, List Trend and Graphic Trend.

6.3.10 Physical Characteristics

6.3.10.1 Mounting

The monitor has the capability to be carried as a portable unit, placed on a tabletop, or mounted to a wall mount, rolling stand, or 1.61" (41 mm) maximum diameter bed rail.

6.3.10.2 Maximum Size

241 mm (9.49 inches) wide (including printer)

228 mm (8.98 inches) high (including handle)

174 mm (6.85 inches) deep (including knob & folded handle)

6.3.10.3 Maximum Weight

4 kg (8.8 lbs), without optional accessories

4.81 kg (10.61 lbs), with 1 Sealed lead acid battery, without optional accessories

4.33 kg (9.52 lbs), with 1 Lithium Ion battery, without optional accessories

6.3.10.4 Cooling Fan

Fan Control

When the unit is powered from an external source (AC), the cooling fan is ON.

The cooling fan is OFF when the unit is powered from the internal battery.

6.3.10.5 Normal Operating Noise

The SPL produced by the unit during normal operating conditions is less than 60 dBA maximum at 1 meter when measured in accordance with ISO 3744. Maximum SPL is measured with no alarms sounding, but all internal mechanical devices (i.e. pumps, fans) running.

6.3.11 Environmental and Safety Characteristics

Storage Temperature	-20 °C to +60 °C
Operating Temperature	+5 °C to +40 °C
Storage Humidity	10% to 95%, non-condensing
Operating Humidity	15% to 95%, non-condensing
Storage Altitude	(-1000 to 20,000 feet ASL) 1050 hPa to 466 hPa (788 mmHg to 349 mmHg)
Operating Altitude	(-1000 to 9,889 feet ASL) 1050 hPa to 700 hPa (788 mmHg to 525 mmHg)
Shipping:	The monitor meets the requirements of ISTA shipping procedure 1A for containerized product, when packed in designated packaging. The shipping carton is marked with the permissible storage conditions for temperature, altitude, and humidity.
Shock:	Remains operational within specification after exposure to 100 g, 6 ms, half sine, shock pulse tested per IEC 68-2-27.
Vibration:	Remains operational within specification after exposure to the following Sinusoidal and Random Vibration Sinusoidal Vibration Per IEC 68-2-6 1 g or 0.07 mm, 57 – 62 Hz crossover frequency 10 to 500 Hz, 10 sweep cycles in each axis Random Vibration Per IEC 68-2-34 0.02 g ² /Hz 20 – 500 Hz Low degree of reproducibility 9 minutes per axis

Drop:	Meets the requirements specified by ECRI PB-296 892 section AIII 3.3 for Class 3 devices.
Impact	Meets the requirements specified by ECRI PB-296 892, section AIII 3.2 for Class 3 devices.

Electromagnetic Compatibility

The **Trio** meets the requirements of IEC 60601-1-2:2001/EN 60601-1-2:2001.

NOTE: **The Trio needs special precautions regarding EMC and needs to be installed and put into service according to the EMC information provided below.**

NOTE: **Portable and mobile RF communications equipment can affect the Trio. See tables 6-1 through 6-4 that follow.**

TABLE 6-1

GUIDANCE AND DECLARATION - ELECTROMAGNETIC EMISSIONS

The **Trio** is intended for use in the electromagnetic environment specified below. The customer or the user of the **Trio** should assure that it is used in such an environment.

EMISSIONS TEST	COMPLIANCE	ELECTROMAGNETIC ENVIRONMENT - GUIDANCE
RF emissions CISPR 11	Group 1	The Trio uses RF energy only for its internal function. Therefore, its RF emissions are very low and are not likely to cause any interference in nearby electronic equipment.
RF emissions CISPR 11	Class A	The Trio is suitable for use in all establishments other than domestic establishments and those directly connected to the public low-voltage power supply network that supplies buildings used for domestic purposes
Harmonic emissions IEC 61000-3-2	Class A	
Voltage fluctuations/ Flicker emissions IEC 61000-3-3	Complies	

TABLE 6-2

GUIDANCE AND DECLARATION - ELECTROMAGNETIC IMMUNITY

The **Trio** is intended for use in the electromagnetic environment specified below. The customer or the user of the **Trio** should assure that it is used in such an environment.

IMMUNITY TEST	IEC 60601 TEST LEVEL	COMPLIANCE LEVEL	ELECTROMAGNETIC ENVIRONMENT - GUIDANCE
Electrostatic discharge (ESD) IEC 61000-4-2	±6 kV contact ±8 kV air	±6 kV contact ±8 kV air	Floors should be wood, concrete or ceramic tile. If floors are covered with synthetic material, the relative humidity should be at least 30%.
Electrical fast transient/burst IEC 61000-4-4	±2 kV for power supply lines ±1 kV for input/output lines	±2 kV for power supply lines ±1 kV for input/output lines	Mains power quality should be that of a typical commercial or hospital environment.
Surge IEC 61000-4-5	±1 kV differential mode ±2 kV common mode	±1 kV differential mode ±2 kV common mode	Mains power quality should be that of a typical commercial or hospital environment.
Voltage dips, short interruptions and voltage variations on power supply input lines IEC 61000-4-11	<5% U_T (>95% dip in U_T) for 0.5 cycle	<5% U_T (>95% dip in U_T) for 0.5 cycle	Mains power quality should be that of a typical commercial or hospital environment. If the user of the Trio requires continued operation during power mains interruptions, it is recommended that the Trio be powered from an uninterruptible power supply or a battery.
	40% U_T (60% dip in U_T) for 5 cycles	40% U_T (60% dip in U_T) for 5 cycles	
	70% U_T (30% dip in U_T) for 25 cycles	70% U_T (30% dip in U_T) for 25 cycles	
	<5% U_T (>95% dip in U_T) for 5 sec	<5% U_T (>95% dip in U_T) for 5 sec	
Power frequency (50/60 Hz) magnetic field IEC 61000-4-8	3 A/m	3 A/m	Power frequency magnetic fields should be at levels characteristic of a typical location in a typical commercial or hospital environment.

U_T is the A.C. mains voltage prior to application of the test level.

TABLE 6-3

GUIDANCE AND DECLARATION - ELECTROMAGNETIC IMMUNITY

The **Trio** is intended for use in the electromagnetic environment specified below. The customer or the user of the **Trio** should assure that it is used in such an environment.

IMMUNITY TEST	IEC 60601 TEST LEVEL	COMPLIANCE LEVEL	ELECTROMAGNETIC ENVIRONMENT - GUIDANCE
			Portable and mobile RF communications equipment should be used no closer to any part of the Trio , including cables, than the recommended separation distance calculated from the equation applicable to the frequency of the transmitter.
			Recommended separation distance
Conducted RF IEC 61000-4-6	3 Vrms 150 kHz to 80 MHz	3 Vrms	$d = 1.2 \times \sqrt{P}$
Radiated RF IEC 61000-4-3	3 V/m 80 MHz to 2.5 GHz	3 V/m	$d = 1.2 \times \sqrt{P}$ 80 MHz to 800 MHz $d = 2.3 \times \sqrt{P}$ 800 MHz to 2.5 GHz
			where P is the maximum output power rating of the transmitter in watts (W) according to the transmitter manufacturer and d is the recommended separation distance in meters (m).
			Field strengths from fixed RF transmitters, as determined by an electromagnetic site survey, ^a should be less than the compliance level in each frequency range. ^b
			Interference may occur in the vicinity of equipment marked with the following symbol: 

NOTE: At 80 MHz and 800 MHz, the higher frequency range applies.

NOTE: These guidelines may not apply in all situations. Electromagnetic propagation is affected by absorption and reflection from structures, objects and people.

^a Field strengths from fixed transmitters, such as base stations for radio (cellular/cordless) telephones and land mobile radios, amateur radio, AM and FM radio broadcast and TV broadcast cannot be predicted theoretically with accuracy. To assess the electromagnetic environment due to fixed RF transmitters, an electromagnetic site survey should be considered. If the measured field strength in the location in which the Trio is used exceeds the applicable RF compliance level above, the Trio should be observed to verify normal operation. If abnormal performance is observed, additional measures may be necessary, such as reorienting or relocating the Trio.

^b Over the frequency range 150 kHz to 80 MHz, field strengths should be less than 3 V/m.

TABLE 6-4**RECOMMENDED SEPARATION DISTANCES BETWEEN PORTABLE AND MOBILE RF COMMUNICATIONS EQUIPMENT AND THE TRIO**

The **Trio** is intended for use in an electromagnetic environment in which radiated RF disturbances are controlled. The customer or the user of the **Trio** can help prevent electromagnetic interference by maintaining a minimum distance between portable and mobile RF communications equipment (transmitters) and the **Trio** as recommended below, according to the maximum output power of the communications equipment.

RATED MAXIMUM OUTPUT POWER (P) OF TRANSMITTER IN WATTS (W)	SEPARATION DISTANCE ACCORDING TO FREQUENCY OF TRANSMITTER M (METERS)		
	150 kHz to 80 MHz $d = 1.2 \times \sqrt{P}$	80 MHz to 800 MHz $d = 1.2 \times \sqrt{P}$	800 MHz to 2.5 GHz $d = 1.2 \times \sqrt{P}$
0.01	0.12	0.12	0.23
0.1	0.38	0.38	0.73
1	1.2	1.2	2.3
10	3.8	3.8	7.3
100	12	12	23

For transmitters rated at a maximum output power not listed above, the recommended separation distance d in meters (m) can be determined using the equation applicable to the frequency of the transmitter, where P is the maximum output power rating of the transmitter in watts (W) according to the transmitter manufacturer.

NOTE: At 80 MHz and 800 MHz, the separation distance for the higher frequency range applies.

NOTE: These guidelines may not apply in all situations. Electromagnetic propagation is affected by absorption and reflection from structures, objects and people.

NOTE: The **Trio** is intended for use in the electromagnetic environment specified below. The customer or the user of the **Trio** should assure that it is used in such an environment.

The **Trio** meets the additional FDA electromagnetic compatibility requirements of the FDA Reviewer Guidance for Premarket Notification Submission (November 1993) listed below:

AC Voltage Dropout: < 10 ms

NOTE: Mains power quality should be that of a typical commercial or hospital environment. If the user of the **Trio** requires continued operation during power mains interruptions, it is recommended that the **Trio** be powered from an uninterruptible power supply or a battery.

AC Slow Sags and Surge: 90 V to 150 V for 500 ms

AC Steady State Voltage: 95 – 132 V, AC/battery switching below 95 V

Quasi-static Fields: 500 – 2000 V/m sweep at 0.5 Hz sine

Magnetic Emissions: MIL-STD-461D, RE101, 30 Hz to 100 kHz @ 7 cm

Isolation:	Risk (Leakage) Currents: Meets the requirements of IEC 60601-1/ EN 60601-1
Enclosure Risk Current:	
Normal operating conditions	$\leq 100 \mu\text{A}$
Single fault condition	$\leq 300 \mu\text{A}$ for 120 VAC
Single fault condition	$\leq 500 \mu\text{A}$ for 230 VAC
Patient Source Current:	
Normal operating conditions	$\leq 10 \mu\text{A}$
Single fault condition	$\leq 50 \mu\text{A}$
Patient Sink Current:	
Normal operating conditions	not applicable
Single fault condition	$\leq 50 \mu\text{A}$
Dielectric Withstand	Per IEC 60601-1/EN 60601-1

6.4 Warranty Statements

Mindray DS USA, Inc. warrants that components within the monitor unit will be free from defects in workmanship and materials for the number of years shown on the invoice. Under this extended warranty, Mindray DS USA, Inc. will repair or replace any defective component at no charge for labor and/or materials. This extended warranty does not cover consumable items such as, but not limited to batteries, displays, external cables and sensors.

Recommended preventative maintenance, as prescribed in the Service Manual, is the responsibility of the user, and is not covered by this warranty.

Except as otherwise provided herein, the terms, conditions and limitations of Mindray DS USA, Inc.'s standard warranty will remain in effect.

USA, Canada, Mexico, and Puerto Rico

Mindray DS USA, Inc. warrants that its products will be free from defects in workmanship and materials for a period of one (1) year from the date of purchase except that disposable or one-time use products are warranted to be free from defects in workmanship and materials up to a date one year from the date of purchase or the date of first use, whichever is sooner. This warranty does not cover consumable items such as, but not limited to, batteries, external cables, sensors, cuffs, hoses, or mounts.

Mindray DS USA, Inc. will not be liable for any incidental, special, or consequential loss, damage, or expense directly or indirectly arising from the use of its products, liability under this warranty and the buyer's exclusive remedy under this warranty is limited to servicing or replacing at Mindray DS USA, Inc.'s option at the factory or at an authorized Distributor, any product which will under normal use and service appear to the Company to have been defective in material or workmanship.

No agent, employee, or representative of Mindray DS USA, Inc. has any authority to bind Mindray DS USA, Inc. to any affirmation, representation, or warranty concerning its products, and any affirmation, representation or warranty made by any agent, employee, or representative will not be enforceable by buyer.

This warranty is expressly in lieu of any other express or implied warranties, including any implied warranty or merchantability or fitness, and of any other obligation on the part of the seller.

Damage to any product or parts through misuse, neglect, accident, or by affixing any non-standard accessory attachments or by any customer modification voids this warranty. Mindray DS USA, Inc. makes no warranty whatever in regard to trade accessories, such being subject to the warranty of their respective manufacturers.

A condition of this warranty is that this equipment or any accessories which are claimed to be defective be returned when authorized by Mindray DS USA, Inc., freight prepaid to Mindray DS USA, Inc., Mahwah, New Jersey 07430. Mindray DS USA, Inc. will not have any responsibility in the event of loss or damage in transit.

Calibration may be performed without the need to disassemble the instrument. It is the responsibility of the purchaser to perform calibration as necessary, in accordance with the instructions provided in this manual.

6.5 Phone Numbers and How To Get Assistance

Mindray DS USA, Inc. maintains a network of service representative and factory-trained distributors. Prior to requesting service, perform a complete operational check of the instrument to verify proper control settings. If operational problems continue to exist, contact the Customer Service Department at (201) 995-8116 for assistance.

Please include the instrument model number, the serial number, and a description of the problem with all requests for service.

Any questions regarding the warranty should be directed to the closest Mindray DS USA, Inc. location. A list of international offices, along with their phone numbers, is provided at the end of this manual.

6.6 Manufacturer's Responsibility

Mindray DS USA, Inc. is responsible for the effects on safety, reliability and performance of the equipment only if:

- a.** assembly operations, extensions, readjustments, modifications or repairs are carried out by persons authorized by Mindray DS USA, Inc.; and
- b.** the electrical installation of the relevant room complies with the appropriate requirements; and
- c.** the equipment is used in accordance with the instructions for use.

*Mindray DS USA, Inc. • 800 MacArthur Boulevard • Mahwah, NJ 07430 • USA •
Dom. Customer Service: 1.800.288.2121 • Intl. Customer Service: +1.201.995.8000 •
Dom. Fax: 1.800.926.4275 • Intl. Fax: +1.201.995.8680 • www.mindray.com*

*Mindray Medical Netherlands B.V. • P.O. Box 26 • 3870 CA Hoevelaken • The Netherlands •
Tel: +31 33 25 44 911 • Fax: +31 33 25 37 621*

*Mindray (UK) Limited • 3 Percy Road • St. John's Park • Huntingdon • Cambridgeshire PE29 6SZ •
United Kingdom • Tel: 01480 416840 • Fax: 01480 436588*

*Mindray Medical France SARL • Europarc Créteil • 123, Chemin des Bassins •
94035 Créteil Cedex • France • Tel: (0)1.45.13.91.50 • Fax: (0)1.45.13.91.51*

*Mindray Medical German GmbH • Zwischen den Bächen 4 • 64625 Bensheim • Germany •
Tel: +49.6251.17524-0 • Fax: +49.6251.17524-20*

*Mindray Medical International Ltd. • 2813 Office Tower, Convention Plaza • No 1 Harbour Road •
Wanchai • Hong Kong • Tel: +852 2793 5596 • Fax: +852 2344 8824*