

# Operating Instructions

**A7**<sup>™</sup>

Anesthesia System

**mindray**

# Operating Instructions

**A7**<sup>™</sup>

Anesthesia System

**mindray**

*A7™ is an U.S. trademarks of Mindray DS USA, Inc.*

*OPTIMIZER® is a registered trademark of Mindray DS USA, Inc.*

*Selectatec® is a registered trademark of Ohmeda.*



# Table of Contents

Foreword .....	ix
Indications For Use .....	ix
Responsibilities of Operators .....	ix
Warnings, Cautions, and Notes .....	ix
Warnings.....	x
Cautions .....	xvi
Notes.....	xix
Warranty Statements .....	xxi
Disclaimers.....	xxi
Phone Numbers and How To Get Assistance.....	xxii
Manufacturer’s Responsibility .....	xxii
Manufacturer and Address .....	xxii
Symbols.....	xxii
<b>Product Description.....</b>	<b>1 - 1</b>
General System Overview .....	1 - 2
General Description.....	1 - 2
Key Features .....	1 - 3
Fresh Gas Dosing .....	1 - 4
Flow Control.....	1 - 4
Flow/Pressure Sensing .....	1 - 4
Vaporizer Mounting.....	1 - 4
Anesthesia Ventilator .....	1 - 5
Breathing System .....	1 - 5
Active Anesthetic Gas Scavenging System (AGSS) .....	1 - 6
Passive Anesthetic Gas Scavenging System (AGSS) .....	1 - 6
Negative Pressure Device.....	1 - 6
Power Management / Battery Supply.....	1 - 6
Workplace Ergonomics.....	1 - 8
Hook.....	1 - 8
Physical Views.....	1 - 9
Main Unit (Front View).....	1 - 9
Main Unit (Rear View).....	1 - 12
Main Unit (Left View).....	1 - 14
Main Unit (Right View).....	1 - 15
Main Unit (Top View).....	1 - 16
Breathing System (Top View) .....	1 - 17
Breathing System (Left View) .....	1 - 18
Active Anesthetic Gas Scavenging System (AGSS) (Top, Right, and Rear Views).....	1 - 20
Passive Anesthetic Gas Scavenging System (AGSS) (Right View) .....	1 - 21
Negative Pressure Suction Device.....	1 - 22
<b>Installation .....</b>	<b>2 - 1</b>
Unpacking.....	2 - 3
Initial Setup.....	2 - 4
Install the Vaporizer.....	2 - 5
Filling and Draining the Vaporizer .....	2 - 7
Install the Suction Canister .....	2 - 8
Turn On the Vacuum Regulator .....	2 - 9
Turn Off the Negative Pressure Suction Device .....	2 - 9
<b>System Interface .....</b>	<b>3 - 1</b>
Main Screen Components.....	3 - 2

System Information Header .....	3 - 4
Elapsed / Countdown Timer .....	3 - 4
Patient Size .....	3 - 5
Alarm and Prompt Messages .....	3 - 5
Alarm Silence Icon.....	3 - 6
Date and Time .....	3 - 7
Battery Status .....	3 - 8
Fresh Gas Flow Display.....	3 - 9
Electronic Flow Control System .....	3 - 9
Total Flow Control Mode .....	3 - 9
Direct Flow Control Mode .....	3 - 10
Fresh Gas Flow Optimizer® (software bundle version 02.09.00 and later) .....	3 - 11
Flow Pause (software bundle version 02.09.00 and later) .....	3 - 14
Backup Flow Control System.....	3 - 15
Waveforms Tab .....	3 - 16
Waveforms Autoscaling .....	3 - 16
Waveforms Manual Scaling .....	3 - 17
Spirometry Tab.....	3 - 18
Loop Type.....	3 - 20
Show Reference .....	3 - 21
Save Loop .....	3 - 21
Review Loops Button .....	3 - 22
Demographics Tab.....	3 - 24
Ventilation Mode Tabs.....	3 - 25
Measured Values Area .....	3 - 27
System Softkeys.....	3 - 28
Setup Softkey .....	3 - 28
Alarms Softkey.....	3 - 28
Silence Softkey .....	3 - 28
Capture Event Softkey .....	3 - 28
History Softkey .....	3 - 28
List Trends .....	3 - 28
Graphic Trends .....	3 - 31
Event Log .....	3 - 34
General Tab .....	3 - 36
Display Tab .....	3 - 38
System Tab.....	3 - 42
Network Configuration.....	3 - 47
Service Tab.....	3 - 49
<b>Preoperative Tests.....</b>	<b>4 - 1</b>
Preoperative Test Schedules .....	4 - 2
Test Intervals .....	4 - 2
Inspect the System.....	4 - 3
Pre-Operative Checkout List.....	4 - 4
Introduction.....	4 - 4
Suggested Pre-Operative Checkout List .....	4 - 4
System Self-Test.....	4 - 6
Leak and Compliance Tests .....	4 - 8
Automatic Circuit Leak and Compliance Test .....	4 - 8
Manual Circuit Leak Test.....	4 - 13
Automatic Backup Flow Control Test.....	4 - 16
Preoperative Check List (software bundle version 02.09.00 and later).....	4 - 18

Power Failure Alarm Test .....	4 - 19
Pipeline Tests .....	4 - 19
O <sub>2</sub> Pipeline Test .....	4 - 19
N <sub>2</sub> O Pipeline Test .....	4 - 19
Air Pipeline Test .....	4 - 20
Basic Ventilation Testing .....	4 - 20
Cylinder Tests .....	4 - 21
Check the Cylinder Pressure .....	4 - 21
O <sub>2</sub> Cylinder High Pressure Leak Test .....	4 - 21
N <sub>2</sub> O Cylinder High Pressure Leak Test .....	4 - 21
Air Cylinder High Pressure Leak Test .....	4 - 21
Flow Control System Test .....	4 - 22
Vaporizer Tests .....	4 - 23
Vaporizer Back Pressure Test .....	4 - 23
Manual Leak Test .....	4 - 24
Vaporizer Leak Test .....	4 - 24
Breathing System Tests .....	4 - 25
Bellows Test .....	4 - 25
Breathing System Leak Test in Manual Ventilation Status .....	4 - 25
APL Valve Test .....	4 - 26
Alarm Tests .....	4 - 27
Prepare for Alarm Tests .....	4 - 27
Test the O <sub>2</sub> Concentration Monitoring and Alarms .....	4 - 28
Test the Low Minute Volume (MV) Alarm .....	4 - 28
Test the Apnea Alarm .....	4 - 28
Test the Continuous Airway Pressure Alarm .....	4 - 29
Test the High Paw Alarm .....	4 - 29
Test the Low Paw Alarm .....	4 - 29
Preoperative Preparations .....	4 - 29
Inspect the Active AGSS .....	4 - 30
Inspect the Negative Pressure Suction Device .....	4 - 30
<b>Operations .....</b>	<b>5 - 1</b>
Powering On the A7 Anesthesia System .....	5 - 2
Powering Off the A7 Anesthesia System .....	5 - 2
Patient Setup .....	5 - 3
End Case / Standby Mode .....	5 - 3
Select the Patient Size (Adult, Pediatric, Infant) .....	5 - 5
Input Fresh Gas .....	5 - 5
Set O <sub>2</sub> , N <sub>2</sub> O and Air Inputs .....	5 - 5
Set Anesthetic Agent .....	5 - 6
Select the Desired Anesthetic Agent .....	5 - 6
Adjust the Concentration of Anesthetic Agent .....	5 - 6
Ventilation Modes .....	5 - 7
Monitored Parameters .....	5 - 7
Ventilation Modes .....	5 - 7
Change Ventilation Mode .....	5 - 7
Set Manual Ventilation Mode .....	5 - 8
Make Settings before Starting Mechanical Ventilation Mode .....	5 - 10
Volume Control Ventilation (VCV) .....	5 - 10
To Set VCV Mode .....	5 - 11
Pressure Control Ventilation (PCV) .....	5 - 11
To Set PCV Mode .....	5 - 12

Synchronized Intermittent Mandatory Ventilation (SIMV).....	5 - 12
Pressure Support in Synchronized Intermittent Mandatory Ventilation (SIMV) .....	5 - 13
Synchronized Intermittent Mandatory Ventilation–Volume Control (SIMV-VC) .....	5 - 13
Synchronized Intermittent Mandatory Ventilation–Pressure Control (SIMV-PC) .....	5 - 13
To Set SIMV-VC or SIMV-PC Mode .....	5 - 14
Pressure Support Ventilation (PS).....	5 - 15
To Set PS Mode .....	5 - 15
Auxiliary Common Gas Outlet (ACGO) Mode.....	5 - 16
Monitor Mode.....	5 - 16
Start Mechanical Ventilation .....	5 - 18
Stop Mechanical Ventilation .....	5 - 18
Relationships of Ventilation Parameters.....	5 - 18
Parameter Monitoring (Numerics) .....	5 - 18
Pressure.....	5 - 18
Volume .....	5 - 19
Gas .....	5 - 19
Parameter Monitoring (Waveforms).....	5 - 20
Pressure Waveform .....	5 - 20
Auto-zeroing the Pressure Sensors .....	5 - 20
Flow Waveform .....	5 - 20
Volume Waveform .....	5 - 21
Gas Waveform.....	5 - 21
Waveform Autoscaling .....	5 - 23
Parameter Monitoring (Spirometry).....	5 - 23
<b>Alarms and Messages .....</b>	<b>6 - 1</b>
Introduction .....	6 - 2
Alarm System Self-Test.....	6 - 2
Types of Alarms and Messages.....	6 - 3
Alarm Indicators.....	6 - 4
Displaying Alarms .....	6 - 5
Displayed Order of Alarm Messages.....	6 - 6
Setting Alarm Volume .....	6 - 7
Silencing Alarms .....	6 - 8
Alarm Limits.....	6 - 9
Setting Alarm Limits .....	6 - 9
Loading Alarm Defaults.....	6 - 12
Auto Alarm Limits.....	6 - 13
Setting CO2 Apnea Delay Time (software bundle version 02.09.00 and later) .....	6 - 14
Alarm and Prompt Messages .....	6 - 14
Physiological Alarm Messages.....	6 - 15
Technical Alarm Messages .....	6 - 17
Startup Alarm Messages .....	6 - 17
CPU Board Runtime Alarm .....	6 - 20
Power Board Runtime Alarm .....	6 - 21
Flow Control System Runtime Alarm .....	6 - 22
Ventilator Control Board Runtime Alarm .....	6 - 23
Anesthetic Gas (AG) Module Alarm Messages .....	6 - 25
Prompt Messages .....	6 - 28
Prompt Messages Displayed in Alarm Area .....	6 - 28
Prompt Messages Displayed in Pop-up Area .....	6 - 29
<b>Maintenance .....</b>	<b>7 - 1</b>
Theory of Operation.....	7 - 3



Block Diagram.....	7 - 3
Maintenance Schedule.....	7 - 4
Breathing System Maintenance.....	7 - 4
Flow Sensor Calibration.....	7 - 5
Water Build-up in the Flow Sensor.....	7 - 6
Prevent Water Build-up.....	7 - 6
Clear Water Build-up.....	7 - 6
AGSS Transfer Tube Maintenance.....	7 - 7
Electrical Safety Inspection.....	7 - 7
Cleaning and Disinfection.....	7 - 8
General Guidelines.....	7 - 8
Cleaning and Disinfecting Agents / Autoclaving.....	7 - 8
External Surfaces.....	7 - 10
Bellows Assembly.....	7 - 10
Inspiration and Expiration Valves.....	7 - 13
APL Valve.....	7 - 16
PAW Gauge.....	7 - 17
Bag Arm.....	7 - 18
Absorber Canister.....	7 - 19
Breathing System Block.....	7 - 22
Active AGSS (Anesthetic Gas Scavenging System) and AGSS Transfer Hose.....	7 - 25
Regular Maintenance.....	7 - 26
<b>AG and O2 Concentration Monitoring.....</b>	<b>8 - 1</b>
Introduction.....	8 - 2
Understand MAC Values.....	8 - 3
Agent Usage Calculation.....	8 - 4
Agent Consumption Speed (Software Bundle Version 02.11.00 or later).....	8 - 5
Identify External AG Modules.....	8 - 5
Prepare to Measure AG.....	8 - 6
Make AG Settings.....	8 - 7
Set CO2 Unit.....	8 - 7
Set CO2 Placement.....	8 - 7
Set CO2 Scale.....	8 - 7
Gas Bench Flow Rate.....	8 - 7
Set Alarm Limits.....	8 - 8
Measurement Limitations.....	8 - 9
Troubleshooting.....	8 - 9
Sample Gas Recirculation.....	8 - 10
Calibrate the AG Module.....	8 - 11
<b>Product Specifications.....</b>	<b>9 - 1</b>
Standards Compliance.....	9 - 2
Safety Designations.....	9 - 3
Oxygen Enriched Environments.....	9 - 4
Wiring and PC Board Materials.....	9 - 4
Physical Specifications.....	9 - 5
Stability Configurations and Conditions.....	9 - 5
Environmental Specifications.....	9 - 6
Electrical Specifications.....	9 - 6
Main Electrical Power Specifications.....	9 - 6
Battery Power Specifications.....	9 - 6
Auxiliary Electrical Outlets.....	9 - 7
Communication Ports.....	9 - 7

Pneumatic Specifications .....	9 - 7
Pipeline Supply.....	9 - 7
Cylinder Supply .....	9 - 8
Auxiliary Common Gas Outlet (ACGO) .....	9 - 8
Vaporizer Connections .....	9 - 8
Drive Gas.....	9 - 8
O <sub>2</sub> Controls .....	9 - 8
Breathing System Specifications .....	9 - 9
Breathing System Volume.....	9 - 9
CO <sub>2</sub> Absorber Assembly.....	9 - 9
Water Collection Cup .....	9 - 9
Breathing System Connections.....	9 - 9
APL Valve .....	9 - 9
Resistance.....	9 - 11
Breathing System Temperature Controller.....	9 - 13
Breathing Circuit Parameters .....	9 - 13
Materials .....	9 - 13
Anesthetic Gas Scavenging System (AGSS) .....	9 - 13
Suction device .....	9 - 13
Monitor Module.....	9 - 14
AG Module .....	9 - 14
Alarms .....	9 - 16
Effect of Interfering Gas on AG Measured Value.....	9 - 17
Monitor Mode.....	9 - 18
Agent Consumption Calculation and Agent Consumption Speed.....	9 - 18
Ventilator Specifications .....	9 - 18
Displays and Controls Specifications .....	9 - 20
Electronic Controls.....	9 - 20
Pneumatic Controls .....	9 - 21
Alarms.....	9 - 22
Safety Specifications .....	9 - 22
ASTM F 1208 – 89 (2005) Disclosures.....	9 - 23
Leakage of Breathing System.....	9 - 23
Resistance of Breathing Systems .....	9 - 24
CO <sub>2</sub> Absorber Resistance.....	9 - 24
CO <sub>2</sub> Absorber Capacity.....	9 - 24
Unidirectional Valve Opening Pressure.....	9 - 24
Data Storage (Non-Volatile) and Recording .....	9 - 24
Response Time of the A7 to an Increase in O <sub>2</sub> Concentration (From 21% to 90%/100%) .....	9 - 25
Electromagnetic Compatibility .....	9 - 26
<b>Accessories .....</b>	<b>A - 1</b>
Accessory Kits .....	A - 2
AG Accessories .....	A - 2
CO <sub>2</sub> Absorbent .....	A - 2
Gas Cylinder Accessories .....	A - 2
Gas Supply Hoses .....	A - 3
Manuals and Reference Cards .....	A - 3
Mounting Accessories .....	A - 3
Networking and USB Storage .....	A - 4
Vaporizers.....	A - 4
Scavenging Accessories.....	A - 5

<b>User Accessible Spare Parts .....</b>	<b>B - 1</b>
Active AGSS .....	B - 2
Breathing System .....	B - 2
CO <sub>2</sub> Absorbent Canister.....	B - 2
Flow Sensor .....	B - 2
Gas Cylinder Accessories .....	B - 3
Negative Pressure Suction Device.....	B - 3
Battery .....	B - 3
<b>Parameters and Factory Defaults .....</b>	<b>C - 1</b>
Waveform/Spirometry Tabs .....	C - 2
Alarm Limits.....	C - 2
Setup Menu .....	C - 4
Alarm Volume.....	C - 6
History .....	C - 6
Date and Time .....	C - 6
Demographics .....	C - 7
Ventilation Modes.....	C - 7
Linked Ventilation Parameter .....	C - 11
Ventilation Parameter Relationships.....	C - 13
<b>Pneumatic Diagram .....</b>	<b>D - 1</b>
Pneumatic Diagram of the A7 System .....	D - 2
<b>Abbreviations, Symbols, and Units of Measure .....</b>	<b>E - 1</b>
Abbreviations .....	E - 2
Symbols.....	E - 4
Units of Measure.....	E - 5
Attention Symbols .....	E - 6
<b>Preparation for Malignant Hyperthermia Susceptible Patients .....</b>	<b>F - 1</b>
Malignant Hyperthermia Causes, Effects and Treatment .....	F - 2
Malignant Hyperthermia Washout .....	F - 2
Washout Procedure for Malignant Hyperthermia Susceptible Patients with A7 Anesthesia Delivery Systems.....	F - 2
References.....	F - 4

**This page intentionally left blank.**

## Foreword

**WARNING:** Do not operate the A7 Anesthesia System before reading this manual.

The operating instructions for the A7 Anesthesia Delivery System (hereinafter referred to as A7 Anesthesia System, A7 System, A7) is intended to provide information for proper installation, operation, and general maintenance of the A7 System to the user.

General knowledge and understanding of the features and functions of the A7 System are prerequisites for its proper use.

For servicing information or assistance, please contact an authorized representative in your area.

**Rx only:** U.S. Federal Law restricts this device to sale by or on the order of a physician or other practitioner licensed by state law to use or order the use of this device.

**NOTE:** Figures in this manual are provided for reference purposes only. Screens may differ based on the system configuration and selected parameters.

## Indications For Use

The A7 Anesthesia System is a device used to administer to a patient, continuously or intermittently, a general inhalation anesthetic, and to maintain a patient's ventilation.

The A7 is intended for use by licensed clinicians, for patients requiring anesthesia within a health care facility, and can be used for adult, pediatric, and infant populations.

**WARNING:** The A7 is intended to be operated only by licensed clinicians and qualified anesthesia personnel who have received adequate training in its use. Anyone unauthorized or untrained must not perform any operation on the A7.

**WARNING:** The A7 is not suitable for use in an MRI environment.

## Responsibilities of Operators

The proper function of the A7 System can only be guaranteed if it is operated and serviced in accordance with the information provided in this manual and by an authorized Mindray service representative. Non-compliance with this information voids all guarantee claims.

The A7 System must be operated by qualified and trained personnel only. All operators must fully observe these operating instructions and relevant additional documentation. They must also comply with the WARNINGS, CAUTIONS, and NOTES detailed in this manual.

## Warnings, Cautions, and Notes

Please adhere to all warnings, cautions, and notes that are listed throughout this manual. They are summarized here for your reference.

**WARNING** — Indicates a potential hazard or unsafe practice that, if not avoided, could result in death or serious injury to the patient or user.

**CAUTION** — Indicates a potential hazard or unsafe practice that, if not avoided, could result in product/property damage or minor personal injury to the patient or user.

**NOTE** — Provides application tips or other useful information to ensure that you get the most from your product.

---

## Warnings

- WARNING:** Do not operate the A7 Anesthesia System before reading this manual.
- WARNING:** All analog or digital products connected to this system must be certified passing the specified IEC standards (such as IEC 60950 for data processing equipment and ANSI/AAMI ES60601-1 for medical electrical equipment). All configurations comply with the valid version of ANSI/AAMI ES60601-1. The personnel who are responsible for connecting the optional equipment to the I/O signal port are responsible for medical system configuration and system compliance with ANSI/AAMI ES60601-1.
- WARNING:** This machine must only be operated by trained, skilled medical staff.
- WARNING:** Before putting the system into operation, the operator must verify that the equipment, connecting cables, and accessories are in correct working order and operating condition.
- WARNING:** The equipment must be connected to a properly installed power outlet with protective earth contacts only. If the installation does not provide for a protective earth conductor, disconnect it from the power line or operate from the equipment's internal battery supply.
- WARNING:** Multiple AC power outlets are provided on the rear of the A7. These outlets are intended to supply power to additional equipment that form a part of the anesthesia system (i.e. vaporizers, gas analyzers, etc.). Do not connect other equipment to these outlets, as patient leakage current may be affected. Each outlet is rated 3 A; the total current that may be drawn through all outlets is 10A on the A7 System; do not attempt to exceed these load ratings. Do not connect additional Multiple Portable Socket Outlets (i.e. Multiple outlet extension cords) (MPSOs) or extension cords to these outlets.
- WARNING:** Do not put MPSOs on the floor.
- WARNING:** Connect the A7 Anesthesia System to an AC power source before depleting the internal battery power source.
- WARNING:** Do not open the equipment housings. Only trained and authorized Mindray personnel may service and perform upgrades.
- WARNING:** Do not rely exclusively on the audible alarm system for patient monitoring.
- WARNING:** Adjustment of alarm volume to a low level may result in a hazard to the patient.
- WARNING:** Customize the alarm settings according to patient's condition and situation. Keeping the patient under constant and close surveillance is the most reliable way for safe patient monitoring.
- WARNING:** The physiological parameters and alarm messages displayed on the equipment screen are for the caregiver's reference only and cannot be directly used as the basis for clinical treatment.
- WARNING:** Dispose of the packaging material, observing the applicable waste control regulations and keeping it out of children's reach.

- WARNING:** To avoid the possibility of explosion, do not use the equipment in the presence of flammable anesthetic agents, vapors or liquids. Do not use flammable anesthetic agents such as ether and cyclopropane for this equipment. Use only non-flammable anesthetic agents that meet the requirements specified in ISO 80601-2-13. Use the A7 Anesthesia System with halothane, enflurane, isoflurane, sevoflurane, and desflurane. Only use one anesthetic agent at a time.
- WARNING:** Fresh gas flow must never be switched off before the vaporizer is switched off. The vaporizer must never be left switched on without a fresh-gas flow. Anesthetic agent vapor at a high concentration can get into the machine lines and ambient air, causing harm to people and materials.
- WARNING:** To avoid the risk of electric shock, this equipment must only be connected to a supply mains with protective earth.
- WARNING:** The use of anti-static or electrically conductive breathing tubes, when utilizing high frequency electric surgery equipment, may cause burns, and is therefore not recommended in any application of this machine.
- WARNING:** Possible electric shock hazard. Only authorized service personnel may open the machine.
- WARNING:** Qualified personnel should visually monitor the patient. Life-threatening circumstances may occur that may not trigger an alarm.
- WARNING:** Always set the alarm limits so that the alarm is triggered before a hazardous situation occurs. Incorrectly set alarm limits may result in operating personnel not being aware of drastic changes in the patient's condition.
- WARNING:** Connection of both medical and non-medical equipment to the auxiliary mains socket outlet(s) may increase the leakage currents to values exceeding the allowable limits.
- WARNING:** Electric shock and fire hazard: Do not clean the machine while it is powered on and/or plugged into an outlet.
- WARNING:** Disconnect the power plug from the mains supply before removing the rear panels or servicing the A7 unit.
- WARNING:** Malfunction of the central gas supply system may cause more than one or even all devices connected to it to stop their operation simultaneously.
- WARNING:** The anesthesia system will cease to deliver gas at pressures below the minimum specified gas pipeline supply pressure.
- WARNING:** Use a cleaning and disinfection schedule that conforms to your institution's disinfection and risk-management policies.
- Refer to the material safety data sheet as applicable.
  - Refer to the operation and maintenance manuals of all disinfection equipment.
  - Do not inhale fumes that may result from any disinfection process.
- WARNING:** Use extreme care while handling the absorbent as it contains a caustic irritant.

- 
- WARNING:** Use care in lifting and manipulating vaporizers during the mounting process as their weight may be greater than expected, based on their size and shape.
- WARNING:** Do not use talc, zinc stearate, calcium carbonate, corn starch, or similar material to prevent sticking of the bellows, as these materials may enter the patient's lungs or airway, causing irritation or injury.
- WARNING:** All gas supplies should be of medical grade.
- WARNING:** Single use respiratory hoses, face masks, sensors, sodalime, water traps, sampling lines, airway adapters, and other single use items may be considered potential biologically hazardous items and should not be reused. Dispose of these items in accordance with hospital policy and local regulations for contaminated and biologically hazardous items.
- WARNING:** Check water build-up inside the flow sensor before every system use. Pooled water in the flow sensor causes erroneous readings.
- WARNING:** Ensure that all breathing system parts are completely dried after the breathing system is cleaned and disinfected.
- WARNING:** To avoid endangering a patient, do not perform testing or maintenance when the machine is in use.
- WARNING:** To ensure compatibility, review the performance specifications of the disposal system by which the transfer and receiving systems are intended to be used.
- WARNING:** Ensure that the current alarm presets are appropriate before use on each patient.
- WARNING:** A hazard can exist if different alarm presets are used for the same or similar equipment in any single area.
- WARNING:** Due to the size and weight of the A7, it should only be moved by qualified personnel.
- WARNING:** Overloading the machine may cause tipping. Equipment attached to the side of the machine should fall within the rated weights to prevent machine tipping.
- WARNING:** Excess load may cause a tip hazard while moving the A7. Before moving, remove all equipment from the top shelf and all monitoring equipment mounted on the side of the A7. Use care when moving the A7 up or down inclines, around corners, and across thresholds. Do not attempt to roll the A7 over hoses, cords, or other obstacles.
- WARNING:** Leaks or internal venting of sampled gas may affect accuracy. Perform the proper preoperative tests to ensure that the device is performing properly. Do not use leaky circuits.
- WARNING:** Connection of the A7 exhaust port to the hospital's waste gas scavenging system is strongly recommended to prevent exposure of hospital personnel to the A7 exhaust gases.
- WARNING:** Operation of the A7 below the minimum flow values may cause inaccurate results.
- WARNING:** Ensure that an independent means of ventilation (e.g. a self-inflating manually powered resuscitator with mask) is available whenever the A7 is in use.



- 
- WARNING:** Usage of accessories found with damaged packaging may cause biocontamination or failure. The operator should check accessory packaging integrity before use.
- WARNING:** Before using the A7 System (after cleaning or disinfecting), power up the system and follow the on-screen prompts to perform the leak test and the compliance test. See section 4.5 (page 4-8) "Leak and Compliance Tests".
- WARNING:** Improperly cleaned materials may result in biocontamination. Use a cleaning and disinfection schedule that conforms to your institution's disinfection and risk-management policies.
- Refer to the material safety data as applicable.
  - Refer to the operation and maintenance manuals of all disinfection equipment.
- The user should follow the recommended disinfection routine for this machine and any reusable accessories.
- WARNING:** If the A7 is damaged in any way that compromises the safety of the patient or user, discontinue use and attach a visible tag that marks the A7 as unusable. Call Mindray Technical Support.
- WARNING:** Oxygen, when present in high concentrations, can significantly increase the chance of fire or an explosion. Oil and grease may spontaneously ignite and as such should not be used where oxygen enrichment may occur.
- WARNING:** Use of lubricants not recommended by Mindray may increase the danger of fire or explosion. Use lubricants approved by Mindray.
- WARNING:** Low-pressure regulators and flow-meters are susceptible to high pressure, and may burst if improperly maintained or disassembled while under pressure. Only qualified personnel should change connectors or disassemble.
- WARNING:** Do not disassemble the low-pressure regulator, flow-metering device, or connector while under pressure. The release of sudden pressure may cause injury.
- WARNING:** Review the specifications of the AGSS transfer and receiving systems and the specifications of the A7 System to ensure compatibility and to prevent a mismatched receiving system.
- WARNING:** Avoid connecting two or more hose assemblies in series as this may cause a loss of pressure and flow.
- WARNING:** A hazard may exist due to the use of improper connectors. Ensure all assemblies use the proper connectors.
- WARNING:** Avoid replacing a high-pressure flexible connection with one of lower nominal inlet pressure.
- WARNING:** Reusing breathing circuits or reusable accessories that are not disinfected may cause cross-contamination. Disinfect the breathing circuits and reusable accessories before use.
- WARNING:** Inspect all breathing system components carefully before each use. Ensure all components do not contain any obstructions or debris that can cause a potential hazard to the patient.
- WARNING:** Use breathing circuits and manual bags in accordance with ASTM F1208 and compatible with standard 22mm male conical fittings per ASTM specifications F 1054.

- WARNING:** The mains plug is used to isolate the Anesthesia System circuits electrically from the SUPPLY MAINS. Do not position the Anesthesia System so that it is difficult to operate the plug.
- WARNING:** Do not touch the patient when connecting the peripheral equipment via the I/O signal ports to prevent patient leakage current from exceeding the requirements specified by the standard.
- WARNING:** If the Drive Gas Pressure Low alarm occurs when the gas supply pressure is greater than 200 kPa, contact your service personnel or us.
- WARNING:** Do not use the OPTIMIZER<sup>®</sup> when higher flows are required such as during induction, emergency, or other times when rapid changes to the concentration of gases in the circuit are desired, or when the chemical pharmacology of the agent being used indicates otherwise. If the OPTIMIZER<sup>®</sup> is used incorrectly, the reaction time of fresh gas concentration changes could increase, also increasing the risk of undesirable soda lime compounds.
- WARNING:** To ensure proper machine operation, user safety, and patient safety, follow all checkout procedures established by the facility before administering anesthesia to the patient.
- WARNING:** Do not use a malfunctioning A7 Anesthesia System. Have all repairs and service done by an authorized service representative.
- WARNING:** Use a cleaning and disinfection schedule that conforms to your institution's disinfection and risk-management policies.
- Refer to the material safety data as applicable.
  - Refer to the operation and maintenance manuals of all disinfection equipment.
  - Do not inhale fumes that may result from any disinfection process.
- WARNING:** Do not use talc, zinc stearate, calcium carbonate, corn starch, or similar material to prevent sticking of the bellows, as these materials may enter the patient's lungs or airway, causing irritation or injury.
- WARNING:** Only use lubricants approved for anesthesia or O2 equipment.
- WARNING:** Do not use lubricants that contain oil or grease. They can burn or explode in the presence of high O2 concentrations.
- WARNING:** Obey infection control and safety procedures. Used equipment may contain blood and body fluids.
- WARNING:** Movable parts and removable components may present a pinch or a crush hazard. Use care when moving or replacing system parts and components.
- WARNING:** Before using the A7 System after cleaning or disinfecting, power up the system and follow the on-screen prompts to perform the leak test and the compliance test. See section 4.5 (page 4-8) "Leak and Compliance Tests".
- WARNING:** Do not perform calibration while the unit is connected to a patient.
- WARNING:** Do not apply high volume watertraps to Infant sized patients. Otherwise, patient injury could result.

- 
- WARNING:** Make sure that all connections are reliable. Any leak in the system can result in erroneous readings due to patient breathing gas mixed with ambient air.
- WARNING:** When using the AG module to perform AG measurements on the patients who are receiving or have recently received anesthetic agents, connect the outlet to the sample gas return port to prevent the medical staff from breathing in the anesthetic agents.
- WARNING:** The operation of the A7 below the minimum amplitude or value provided in technical specifications may cause inaccurate results.
- WARNING:** Using accessories, sensors and cables other than those specified may result in increased electromagnetic emission or decreased electromagnetic immunity of the equipment.
- WARNING:** The A7 or its components should not be used adjacent to or stacked with other equipment. If adjacent or stacked use is necessary, the A7 or its components should be observed to verify normal operation in the configuration in which it will be used.
- WARNING:** Other devices may interfere with this equipment even though they meet the requirements of CISPR.
- WARNING:** Use only accessories specified in this manual. Using other accessories may cause incorrect measured values or equipment damage.
- WARNING:** Disposable accessories cannot be reused. Reuse may degrade performance or cause cross-contamination.
- WARNING:** Check the accessories and their packages for damage. Do not use them if any sign of damage is detected.
- WARNING:** At the end of its service life, the equipment, as well as its accessories, must be disposed of in compliance with the guidelines regulating the disposal of such products, and in accordance with local regulations for contaminated and biologically hazardous items.
- WARNING:** Ensure that the correct anesthetic agent is used. The vaporizer is designed with the specific anesthetic agent named on it and further indicated by color coded labelling. The concentration of the anesthetic agent actually output will vary if the vaporizer is filled with the wrong agent.
- WARNING:** Do not reuse the agent drained from the vaporizer. Treat as a hazardous chemical and follow local regulations for proper disposal.
- WARNING:** The suction shall be used with a suction catheter.
- WARNING:** Do not modify this equipment without authorization of the manufacturer.
- WARNING:** Connecting electrical equipment to MSO(multiple socket-outlets) effectively leads to create an ME(medical electrical) system, and can result in a reduced level of safety.
- WARNING:** The anesthesia system shall not be serviced or maintained while being connected on a patient.
- WARNING:** Additional MULTIPLE SOCKET- OUTLET or extension cord shall not be connected to the ME SYSTEM.

---

## Cautions

- CAUTION:** To ensure patient safety, use only parts and accessories specified in this manual.
- CAUTION:** At the end of its service life, dispose of the equipment, and its accessories in compliance with the guidelines regulating the disposal of such products, and in accordance with local regulations for contaminated and biologically hazardous items.
- CAUTION:** Magnetic and electrical fields are capable of interfering with the proper performance of the equipment. Ensure that all external devices operating in the vicinity of the equipment comply with the relevant EMC requirements. Mobile phones, x-ray equipment, and MRI devices are possible sources of interference as they may emit higher levels of electromagnetic radiation.
- CAUTION:** This system operates correctly at the electrical interference levels identified in this manual. Higher levels can cause nuisance alarms that may stop mechanical ventilation. Be aware of false alarms caused by high-intensity electrical fields.
- CAUTION:** The A7 Anesthesia System may become unstable if the unit is tilted beyond 10 degrees. Use extreme caution when moving or resting the unit on surfaces exceeding a 10 degree slope. Do not hang articles on the sides of the unit that would cause an excessive imbalance.
- CAUTION:** Perform the daily checks specified on the checklist. In case of a system fault, do not operate the system until the fault has been corrected.
- CAUTION:** Before starting the machine, users must be familiar with the information contained in these operating instructions and must have been trained by an authorized representative.
- CAUTION:** If the machine does not function as described, it must be examined and repaired as necessary by qualified service personnel before being returned to use.
- CAUTION:** Handle the machine with care to prevent damage or functional faults.
- CAUTION:** Ensure that the gas supply of the machine always complies with the technical specifications.
- CAUTION:** Before clinical use, the machine must be correctly calibrated and/or the respective tests must be performed, as described in these operating instructions.
- CAUTION:** Do not operate the machine if system faults occur during the initial calibration or testing or until correcting the faults by qualified service personnel.
- CAUTION:** After servicing, functional, sensor, and system tests must be performed before clinical use.
- CAUTION:** Only vaporizers with Selectatec Interlock-Systems may be used with the A7 unit.
- CAUTION:** After each exchange of a vaporizer, perform a vaporizer leak test.
- CAUTION:** Use cleaning agents sparingly. Excess fluid could enter the machine, causing damage.

- CAUTION:** Do not autoclave any parts of the A7 unless specifically identified as autoclavable in this manual. Clean the A7 only as specified in this manual.
- CAUTION:** To prevent system damage:
- Refer to the literature supplied by the manufacturer of the cleaning agent.
  - Never use organic, halogenated or petroleum-based solvents, anesthetics, glass cleaning agents, acetone or other irritant agents.
  - Never use abrasive agents (i.e. steel wool or silver polish) to clean components.
  - Keep all liquids away from electronic components.
  - Prevent liquid from entering the equipment.
  - All cleaning solutions used must have a pH between 7.0 and 10.5.
- CAUTION:** Do not use acetic hydroperoxide or formaldehyde steaming.
- CAUTION:** The valve disc in each of the inhalation and exhalation valve assemblies on the breathing system is fragile and must be handled with care while removing the valve cage from the valve assembly.
- CAUTION:** If moisture remains in the bellows after cleaning, the bellows surface folds may become tacky and prevent the bellows from properly expanding. Ensure all moisture is removed from the bellows after cleaning.
- CAUTION:** Only connect Mindray approved equipment to the A7 communication ports. Equipment connected to the A7 ethernet ports must comply with IEC 60950.
- CAUTION:** Do not connect any non-isolated devices to the DB9/RS232C interface of the A7.
- CAUTION:** Do not connect any devices to the SB ports other than Mindray approved USB storage devices and a supported USB mouse(See "Networking and USB Storage" on page A-4.).
- CAUTION:** Do not autoclave the following components: Paw gauge, flow sensor, and bellows. These components cannot withstand immersion or the heat and pressure of autoclaving.
- CAUTION:** Users should monitor oxygen percentage (FiO<sub>2</sub>%) when using the Auxiliary O<sub>2</sub>/Air Flow Meters. Unknown oxygen concentrations may be delivered to the patient unless oxygen monitoring is used.
- CAUTION:** The A7 is NOT suitable for use in a magnetic resonance imaging (MRI) environment.
- CAUTION:** To ensure measurement accuracy and to avoid possible damage to the A7, use only Mindray-approved cables and accessories.
- CAUTION:** Use the power cord provided with the product. If a substitute is necessary, use only hospital grade power cords.
- CAUTION:** Do not use a damaged or broken unit or accessory. Periodically check all cables (e.g., AC line cord and patient connection cables) for damage that may occur through normal use. Replace cables if damaged in any way.

- 
- CAUTION:** Use of other oxygen sensors may cause improper oximeter performance.
- CAUTION:** Unintended movement may occur if the casters are not locked. The operator should lock casters during use of the machine.
- CAUTION:** Unsecured devices may slide off the top shelf. Devices should be securely attached to the top shelf.
- CAUTION:** The voltage on the auxiliary outlets is the same voltage as the outlet into which the A7 machine is plugged. Ensure that devices plugged into the auxiliary outlets are rated for the same supply voltage as the A7.
- CAUTION:** During the transport and storage of the vaporizer, block the gas inlet and outlet of the vaporizer with plugs to prevent foreign substances from entering the vaporizer.
- CAUTION:** Do not use any flow outlets as handles for moving the A7. The flow outlets may become damaged. Use the metal side bars on the main body when moving the A7.
- CAUTION:** Do not push down on the bag arm forcefully or hang heavy objects onto it. Excessive weight may bend and damage the bag arm.
- CAUTION:** Use caution when disconnecting "quick connectors", as the sudden release of pressure may cause injury.
- CAUTION:** Avoid factors that can contribute to deterioration of the hose assemblies. Factors include excessive bending, crushing, abrasion, system pressures and temperatures that exceed hose ratings, and improper installation.
- CAUTION:** Use care in lifting and manipulating the breathing system block during removal from its mounting arm as handling may be awkward due to its weight and shape.
- CAUTION:** When the electronic mixer is disabled, the backup flow control valve can work. The initial flow is 1 L/min of O<sub>2</sub>. The backup flow display only has a total flowmeter which range is up to 10 L/min.
- CAUTION:** Turn the backup flow controls slowly. To avoid damaging the control valves, do not turn further when the flowmeter reading is outside the range. When turning a flow control knob clockwise to decrease flow, the flowmeter should reach 1 L/min before the knob reaches its most clockwise mechanical stop (off) position. Do not turn any further when the knob has reached the off position. Turning a flow control knob counterclockwise increases flow.
- CAUTION:** Position the airway adapter properly so that the part connecting to the gas sampling tube is pointing upwards. This prevents condensed water from entering the gas sampling tube and causing an occlusion as a result.
- CAUTION:** The watertrap collects water drops condensed in the sampling tube and therefore prevents them from entering the module. If the collected water reaches a certain amount, you should drain it to avoid airway blockage.
- CAUTION:** The watertrap has a filter preventing bacterium, vapor and patient secretions from entering the module. After a long-term use, dust or other substances may compromise the performance of the filter or even block the airway. In this case, replace the watertrap. Replacing the watertrap once a month is recommended.

**CAUTION:** The AGSS three ways connector provides an inlet to the AGSS when the ACGO circuit is used. Keep the inlet port cover closed when the ACGO circuit is not used.

## Notes

- NOTE:** Figures in this manual are provided for reference purposes only. Screens may differ based on the system configuration and selected parameters.
- NOTE:** Put the equipment in a location where you can easily see the screen and access the operating controls.
- NOTE:** Keep this manual close to the equipment so that it can be obtained conveniently when needed.
- NOTE:** The software was developed in compliance with ANSI/ AAMI ES60601-1. The possibility of hazards arising from software errors is minimized.
- NOTE:** This manual describes all features and options. Your equipment may not have all of them.
- NOTE:** The A7 is intended to be operated with its integral Breathing Pressure monitoring in use.
- NOTE:** The A7 is intended to be operated with its integral Breathing Pressure limitation devices in use.
- NOTE:** The A7 is intended to be operated with its integral Exhaled Volume monitoring in use.
- NOTE:** The A7 is intended to be operated with its integral Breathing System integrity Alarm System in use.
- NOTE:** The A7 is intended to be operated with its integral Continuing Pressure Alarm in use.
- NOTE:** The A7 is intended to be operated with its integral O<sub>2</sub> monitoring in use.
- NOTE:** The A7 is intended to be operated with an external CO<sub>2</sub> monitor complying with ISO 80601-2-55. Connection to the CO<sub>2</sub> monitor should be via a sample line from the patient circuit.
- NOTE:** An Anesthesia Vapor Delivery Device is to be used with an Anesthetic Agent Monitor complying with ISO 80601-2-55. Connection to the Agent monitor should be via a sample line from the Patient Circuit.
- NOTE:** Continuously monitor the anesthetic agent concentration when using the Anesthesia System to ensure accurate output of the anesthetic agent.
- NOTE:** Check the liquid level of the anesthetic agent before and during all operations. When the liquid level is below the warning line, more anesthetic agent needs to be added. Refer to the vaporizer Instructions For Use for filling the vaporizer and other information.
- NOTE:** The A7 System is designed to be equipped with an anesthetic vapor delivery device that complies with ISO 80601-2-13.

- 
- NOTE:** The A7 battery supply is not a user serviceable component. Only an authorized service representative can replace the battery supply. If the system is not used for an extended period, contact a service representative to have the battery supply disconnected. The batteries may be subject to local regulations regarding disposal. At the end of the battery life, dispose of the battery supply in accordance with local regulations.
- NOTE:** Areas designated for the servicing of oxygen equipment shall be clean, free of oil and grease, and not used for the repair of other equipment.
- NOTE:** Opening the cylinder valve quickly may cause unexpected pressure differentials and create a potential for fire or explosion arising from oxygen pressure shocks. Open and shut the cylinder valve slowly.
- NOTE:** Accuracy of the flowrate may be affected by varying inlet pressure, varying outlet resistance, or varying ambient temperature.
- NOTE:** The power device, terminal units and pipeline system can be supplied by one or several different manufacturers.
- NOTE:** Regional or national regulations that apply to manufacturers of medical devices can exist.
- NOTE:** The measured values displayed on the screen are measured under BTPS conditions.
- NOTE:** For the method of connecting A7 to external monitor or other devices, please see Anesthesia Machine Bracket Installation Instructions.
- NOTE:** No repair should ever be attempted by anyone not having experience in the repair of devices of this nature. Replace damaged parts with components manufactured or sold by Mindray. Then test the unit to ensure that it complies with the manufacturer's published specifications.
- NOTE:** The A7 can be equipped with one scavenger system to provide the best match with the hospital's waste-gas disposal system. The scavenger system shall comply with ISO 80601-2-13.
- NOTE:** The A7 can be compatible with O<sub>2</sub>, N<sub>2</sub>O, air, halothane, enflurane, isoflurane, sevoflurane and desflurane.
- NOTE:** Any patches will be deployed by trained engineering personnel at the customer site.
- NOTE:** The Anesthesia System is compatible with gases (O<sub>2</sub>, N<sub>2</sub>O, and Air) and anaesthetic agents (Halothane, Enflurane, Isoflurane, Sevoflurane, and Desflurane).
- NOTE:** The leakage of AGSS is measured by the method recommended in ISO 80601-2-13.



## Warranty Statements

Mindray DS USA, Inc. warrants that components within the anesthesia system will be free from defects in workmanship and materials for the number of years shown on the invoice. Under this extended warranty, Mindray DS USA, Inc. will repair or replace any defective component at no charge for labor and/or materials. This extended warranty does not cover consumable items such as (but not limited to) batteries and external cables.

Calibration may be performed without the need to disassemble the instrument. It is the responsibility of the purchaser to perform calibration as necessary, in accordance with the instructions provided in this manual.

Recommended preventative maintenance, as prescribed in the Maintenance section of this manual, is the responsibility of the user, and is not covered by this warranty.

Except as otherwise provided herein, the terms, conditions, and limitations of Mindray DS USA, Inc.'s standard warranty will remain in effect.

Mindray DS USA, Inc. warrants that its products will be free from defects in workmanship and materials for a period of one (1) year from the date of purchase except that disposable or one-time use products are warranted to be free from defects in workmanship and materials up to a date one year from the date of purchase or the date of first use, whichever is sooner. This warranty does not cover consumable items such as, but not limited to, batteries, external cables, CO<sub>2</sub> absorbents, breathing circuits, hoses, or mounts.

Mindray DS USA, Inc. will not be liable for any incidental, special, or consequential loss, damage, or expense directly or indirectly arising from the use of its products, liability under this warranty and the buyer's exclusive remedy under this warranty is limited to servicing or replacing at Mindray DS USA, Inc.'s option at the factory or at an authorized distributor, any product which shall under normal use and service appear to the Company to have been defective in material or workmanship.

No agent, employee, or representative of Mindray DS USA, Inc. has any authority to bind Mindray DS USA, Inc. to any affirmation, representation, or warranty concerning its products, and any affirmation, representation or warranty made by any agent, employee, or representative shall not be enforceable by buyer.

This warranty is expressly in lieu of any other express or implied warranties, including any implied warranty or merchantability or fitness, and of any other obligation on the part of the seller.

Damage to any product or parts through misuse, neglect, accident, or by affixing any non-standard accessory attachments or by any customer modification voids this warranty. Mindray DS USA, Inc. makes no warranty whatsoever in regard to trade accessories, such being subject to the warranty of their respective manufacturers.

A condition of this warranty is that this equipment or any accessories which are claimed to be defective be returned when authorized, freight prepaid to Mindray DS USA, Inc., Mahwah, New Jersey 07430. Mindray DS USA, Inc. shall not have any responsibility in the event of loss or damage in transit.

## Disclaimers

Product Improvements — Mindray DS USA, Inc. retains the right to modify the machine and/or operating instructions without prior notification. These operating instructions explain all features of the A7 System and are correct at time of manufacture. Instructions and models produced at a later stage, may contain improvements or modifications that were not included in previous models.

## Phone Numbers and How To Get Assistance

A network of service representatives and factory-trained distributors is available. Prior to requesting service, perform a complete operational check of the instrument to verify proper control settings. If operational problems continue to exist, contact the Service Department at (800) 288-2121, ext: 8116 for Technical Support or (201) 995-7875 for assistance in determining the nearest field service location.

Please include the instrument model number, the serial number (located on the back of the A7), and a description of the problem with all requests for service.

Warranty questions should be directed to a local representative. A list of offices, along with their phone numbers, is provided at the end of this manual.

**NOTE:**        **Upon request, calibration instructions or other information will be provided to assist the user's appropriately qualified technical personnel in repairing those parts of the A7 which are designated as repairable.**

## Manufacturer's Responsibility

The effects on safety, reliability, and performance of the equipment are the manufacturer's responsibility only if:

- a. assembly operations, extensions, readjustments, modifications or repairs are carried out by authorized personnel; and
- b. the electrical installation of the relevant room complies with the appropriate requirements; and
- c. the equipment is used in accordance with the instructions for use









## Manufacturer and Address

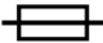
















Manufacturer:                    Shenzhen Mindray Bio-Medical Electronics Co., Ltd.

Address:                            Mindray Building, Keji 12th Road South, High-tech industrial park, Nanshan, Shenzhen 518057, P.R. China

## Symbols

The following table provides descriptions of symbols that are used on the device and/or within this manual.

SYMBOL	DESCRIPTION	SYMBOL	DESCRIPTION
	Caution		Environment: Temperature Range
	Defibrillator proof type BF equipment		Environment: Humidity Range
	Electrical: Alternating Current (AC)		Environment: Pressure Range
	Electrical: Equipotentiality		Gas Cylinder

	Electrical: Fuse or circuit breaker		Gas Inlet
	Electrical: Input Output		Gas Outlet
	Electrical: Internal Battery		Gas Flow: Flow Control
	Electrical: Light	<b>MAX</b>	Gas Flow: Maximum
	Electrical: Power On	<b>MIN</b>	Gas Flow: Minimum
	Electrical: Power Standby		Gas Flow Total
	Electrical: Protective Earth (Ground)	<b>O<sub>2</sub>+</b>	Gas: O <sub>2</sub> Flush
	Electrical: WEEE (Waste of Electrical and Electronic Equipment) Marking. Separate treatment from general waste at end of life.	<b>O<sub>2</sub>%</b>	O <sub>2</sub> Sensor Connector
	Identifier: Manufacturer		Gas Pipeline Connection
<b>REF</b>	Identifier: Manufacturer's Reference/Catalog Number	<b>&gt;PPSU&lt;</b>	Material: Polyphenyl-sulfone
<b>SN</b>	Identifier: Serial Number Indicator	<b>&gt;PSU&lt;</b>	Material: Polysulfone
	Lock/Unlock: Direction		Touchpad
	Lock/Unlock: Lock		Manual ventilation via Breathing Bag
	Lock/Unlock: Unlock		Automatic Ventilation



No Heavy Objects  
Do Not Crush



Water Trap

134°C

Autoclavable



Do Not Oil



Not Autoclavable



Filter Access



Caution: Hot



Direction of flow



Water Drain



5 kg MAX  
11 lbs MAX

Drawer weight limit



MR Unsafe - do not  
subject to magnetic  
resonance imaging  
(MRI)



Conforms to AAMI Std. ES  
60601-1, IEC Std.60601- 1-  
8, ISO Std. 80601-2-13, ISO  
Std. 80601-2-55.  
Certified to CSA Std. C22.2  
No. 60601-1, CSA Std. C22.2  
No.60601-1-8, ISO Std.  
80601-2-13, ISO Std.  
80601-2-55.



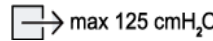
Canister opened



Canister closed



Refer to instruction  
manual/booklet



Maximum pressure of  
ACGO separate outlet



Warning

IPX1

Protection against  
vertically falling water  
drops



VGA port



Battery supply fully charged. AC power connected and is powering the system.



Alarm Icon



Battery supply partially charged. AC power connected, charging battery supply, and power system.



Alarm Silence Icon



Battery supply fully charged and is powering the system. AC power not connected.



Low priority message



Battery supply partially charged and is powering the system. AC power not connected.



Medium priority message



Battery supply has a low charge and is powering the system. Recharging recommended. AC power not connected.



High priority message



Battery supply not installed.



Breathing System Warmer Off

---

**This page intentionally left blank.**

---

1.0

# ***Product Description***

---

General System Overview .....	1-2
Physical Views .....	1-9

# 1.1 General System Overview

## 1.1.1 General Description

The A7 Anesthesia System is a device intended to administer, continuously or intermittently, a general inhalation anesthetic to a patient, and to maintain a patient's ventilation. The A7 also provides for ventilatory monitoring of the patient. The anesthesia system is intended to be used in the patient environment.

The A7 Anesthesia System consists of a main unit (includes an anesthetic ventilator, electronic flow control system, and backup flow control system) and a detachable breathing system. The applied parts of the anesthesia system are breathing tubes and masks. Connect the patient to the anesthesia system via breathing tubes and masks.

The A7 Anesthesia System provides the following ventilation modes:

- Volume Control Ventilation (VCV), which includes the Pressure Limit Ventilation (PLV) function
- Pressure Control Ventilation (PCV) with/without Volume Guarantee (VG) ventilation mode
- Synchronized Intermittent Mandatory Ventilation (SIMV) with VC mode (with/without PS option)
- Synchronized Intermittent Mandatory Ventilation (SIMV) with PC mode (with/without PS option)
- Pressure Support (PS) ventilation mode
- Spontaneous ventilation in Manual mode with APL fully open.
- Manual Ventilation through the use of a breathing bag.
- Cardiac Bypass mode
- Monitor Mode
- ACGO Mode

Electronic PEEP is available in all automatic ventilation modes. User control of the inspiratory flow rise (Tslope) is possible in PCV, SIMV, and PS modes. Automatic fresh gas compensation limits the effect on the patient ventilation from changes in fresh gas flow rate by the operator. The traditional bellows system is driven by oxygen and makes patient disconnections clearly visible.

The A7 Anesthesia System provides the following common functions:

- Automatic leak detection
- Circuit gas leakage compensation and automatic compliance compensation
- Cylinder and central pipeline gas supply connections available for gas input
- Electronically adjustable PEEP
- Electronic timer to display the duration between the start and end of an operation
- Top light available
- External connect on to a patient monitor
- Network upgrade
- Flow trigger mode available for PS and SIMV
- Auxiliary O<sub>2</sub> and air supply
- Active AGSS or optional Passive scavenging
- N<sub>2</sub>O cutoff
- Cardiac Bypass alarm mode



- DEMO
- Agent consumption meter
- Integrated gas bench with 5 agents, O<sub>2</sub>, CO<sub>2</sub> and N<sub>2</sub>O monitoring
- ACGO (Auxiliary Common Gas Outlet)
- Electronic mixer
- Access to the Standby mode when manual ventilation state is activated.
- Integrating based on HL7/IHE-PCD via Ethernet; and connectivity to EMR system and Mindray Monitors via USB and/or RS-232
- Integrated suction
- APL Valve with quick release
- Monitor mode
- Fresh Gas Flow Optimizer®
- Flow Pause

## 1.1.2 Key Features

FEATURE	DESCRIPTION
Display	15 inch color LCD with touchscreen.
Navigation	Graphical user interface for easy navigation.
Ventilation	Manual and automatic ventilation modes and monitoring: VCV, SIMV-VC, PCV, SIMV-PC, PS, and Manual.
Fresh Gas Delivery	Continuous and intermittent anesthesia flow, gas cylinders, pipeline gas supplies, flow control systems (electronic flow control system and backup flow control system) and flow display (total flowmeter and electronic flowmeter).
Breathing System	Heated, adjustable swivel, side hose ports, single turn APL valve with quick release.
Ergonomics	Large stainless steel work surface. Adjustable breathing system block via swivel up to 50 degrees.
Electronic PEEP	Positive End Expiratory Pressure (PEEP) is set and controlled electronically.
Clear Data Display	Four large waveforms for pressure, flow, volume, and CO <sub>2</sub> or Spirometry Loops.
USB Mouse Support	The A7 System supports a wired USB mouse, which can be plugged into one of the two SB ports at the rear of the unit. A cursor appears when the mouse is plugged. The cursor disappears if the user touches the screen or after 15 seconds of mouse inactivity.  The USB mouse can serve as a backup to both the touchscreen and touchpad.

### 1.1.3 Fresh Gas Dosing

The A7 fresh gas dosing subsystem offers the following features:

- Virtual on-screen dual flow tube and numerical readouts to display the flows or concentrations (for electronic flow control system)
- A knob guard to prevent inadvertent movement of the flow control knobs
- Gas supply gauges to indicate the gas pipeline supply pressures and gas cylinder pressures
- Mechanical total flowmeter to display the combined flow of O<sub>2</sub> and Air (for backup flow control system)
- An O<sub>2</sub> flush button
- A single auxiliary combined output with O<sub>2</sub> and Air flowmeters

Safety systems within the A7 work to prevent hypoxic mixtures from being delivered to the patient. Nitrous oxide will not be delivered unless oxygen flow is present. A pneumatic safety system assures that at least 21% O<sub>2</sub> is present when setting mixtures of O<sub>2</sub> and N<sub>2</sub>O. Additionally, if the A7 is placed in the Standby mode, O<sub>2</sub> fresh gas flow is not available.

**WARNING:** When backup flow control system is in use, ensure that both O<sub>2</sub> and air flow controllers are turned OFF fully at the start and at the end of each case.

All A7 units are designed to maintain a safe O<sub>2</sub> : N<sub>2</sub>O ratio by allowing nitrous oxide to be set to a flow rate that is proportional to a previously adjusted flow of oxygen. The N<sub>2</sub>O flow is limited by the flow of O<sub>2</sub> so that a safe ratio of no less than 21% oxygen can be maintained. The A7 is designed to maintain oxygen flow at its previously set level when N<sub>2</sub>O is decreased.

### 1.1.4 Flow Control

#### Flow Control System and Knob:

The fresh gas flow is electronically controlled by the Electronic Flow Control System (hereinafter referred to as EFCS). You can set the flow value or O<sub>2</sub> concentration value via soft keyboard or knobs. When the A7 System detects a failure related to the EFCS, the Backup Flow Control System (hereinafter referred to as BFCS) will be automatically deployed. Two independent flow control knobs allow setting the input flow rates of Air and O<sub>2</sub>.

#### O<sub>2</sub> Pressure Loss Alarm:

An O<sub>2</sub> pressure loss alarm announces when oxygen pressure is less than 220 kPa (32 psi).

#### 1.1.4.1 Flow/Pressure Sensing

The breathing system block contains patient flow and pressure sensors to measure inspiratory flow, expiratory flow, and inspiratory pressure. These sensors enable spirometry and standard pressure and flow monitoring.

### 1.1.5 Vaporizer Mounting

The A7 contains a 2-position Selectatec-type vaporizer mounting system to enable anesthetic agents to be introduced into the fresh gas flow. The mounting system adapts vaporizers with interlock, which permits only one agent at a time to be administered. Lighting above the vaporizers enables them to be seen in a dim light environment. Maximum three vaporizers can be mounted at any one time. The A7 comes standard with a two vaporizer mount. Third vaporizer mount is optional. Halothane, Enflurane, Isoflurane, Desflurane, and Sevoflurane vaporizers can be used.

Additional, non-functional vaporizer parking spot on the side of the unit is provided as part of the standard configuration.

## 1.1.6 Anesthesia Ventilator

The A7 ventilator offers multiple ventilation modes: Volume Control Ventilation (VCV), Synchronized Intermittent Mandatory Ventilation-Volume Control (SIMV-VC), Pressure Control Ventilation (PCV), Pressure Support (PS) ventilation, Pressure Control Ventilation (PCV) with and without Volume Guarantee (VG), Synchronized Intermittent Mandatory Ventilation-Pressure Control (SIMV-PC), and Manual ventilation.

## 1.1.7 Breathing System

A portion of the patient circuit is integrated into an assembly block called the breathing system. The system contains a temperature controller, which warms the block to a temperature of 35°C typical at 20°C ambient temperature to limit the formation of water condensate. The breathing system can be swiveled horizontally up to 50 degrees for user convenience.

The breathing system provides access to the APL valve and breathing bag along with a view of the airway pressure gauge. The APL valve has a single turn knob with quick release that provides a clear view of the manual breathing pressure setting. The absorber assembly incorporates a cam-lock device that opens and closes to provide access to the absorber canister. Either a Pre-Pak or loose fill CO<sub>2</sub> absorbent can be used. Two water traps that can be drained are located on the CO<sub>2</sub> absorber assembly and on the breathing system block.

**NOTE: Operating the A7 with a full water trap in the breathing system block does not allow the water to condense appropriately. The trap should be removed and emptied when filled with water.**

Two (2) flow sensors in the breathing system measure inspired and expired gases for control and monitoring. Breathing pressure is monitored with both a PAW gauge (mechanical) and electronic gauge. The breathing system can be swiveled for ease of positioning. A leak test port is provided to allow for leak testing during startup.

The main pneumatic components of the breathing system are as follows:

- Inspiratory Valve (passive)
- Expiratory Valve (passive)
- Airway Pressure Limiting Valve (APL)
- CO<sub>2</sub> Absorber Assembly
- Bellows Assembly
- Auto/Manual ventilation switch
- Bag arm
- PAW Gauge

The breathing system connects to the A7 main unit through the following ports:

- Drive gas port, designed for use with oxygen as the drive gas
- Fresh gas port
- Exhaust gas port
- Flow sensor pressure transmission pipeline port

The breathing system contains the following ports for end-user connections:

- Inspiratory port for Inspiratory hose of patient breathing circuit
- Expiratory port for Expiratory hose of patient breathing circuit
- Manual Breathing Bag Arm
- Water trap
- Leak test port for sealing the breathing circuit during leak testing

### 1.1.8 Active Anesthetic Gas Scavenging System (AGSS)

The A7 includes a waste gas scavenger that attaches to the side rail mount on the system. The A7 provides a port for the connection of the waste line from an anesthetic gas monitor.

### 1.1.9 Passive Anesthetic Gas Scavenging System (AGSS)

The A7 includes a passive waste gas scavenger. The inlet port of the scavenger connects with the AGSS port and the exhaust port connects with the hospital's waste gas scavenging system.

### 1.1.10 Negative Pressure Device

The negative pressure device is mainly composed of negative pressure regulator. It is used for collecting medical waste liquid and provides overflow protection to prevent fully collected waste liquid from flowing backward so as to ensure the tubing safety.

### 1.1.11 Power Management / Battery Supply

The advanced power management system of the A7 provides AC power for main system functions while charging the system's internal battery supply. During AC power failure, the A7 will operate on battery power for a minimum of 90 minutes with two (2) new batteries installed. See "Battery Power Specifications" on page 9-6.

A recessed main switch is provided to power the system ON and to put the system in the **Standby** mode where the battery supply continues to charge as necessary when the A7 is plugged into an external power source. The main switch also stops the O<sub>2</sub> fresh gas supply when the A7 is placed in the **Standby** mode.

Auxiliary AC outlets on the rear of the machine operate independently of the main switch position. The A7 provides four (4) auxiliary AC outlets. The auxiliary AC outlets are not powered when operating the A7 on the internal battery supply.

**NOTE: Use the battery supply in the A7 at least once every month to extend battery life. Charge the battery supply before its power capacity is depleted.**

**NOTE: Inspect and replace the battery supply at regular service intervals. Long-term battery life depends on how frequent and how long the battery supply is used. For a properly maintained and stored lithium-ion battery, its long-term life expectancy is approximately three (3) years. In more aggressive usage, life expectancy can be shortened. Replacing lithium-ion batteries every three (3) years is recommended.**

**NOTE:** The operating time of a battery depends on equipment configuration and operation.



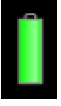
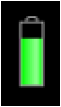

**NOTE:** In case of battery failure, contact Mindray service personnel for battery supply replacement.

**CAUTION:** Please replace your battery when it reaches the end of its service life. Failure to replace the battery may cause serious damage to your device from battery overheating.


The A7 Anesthesia System is designed to operate on battery power whenever AC power is interrupted. When the A7 is connected to an AC power source, the battery supply is charged whether or not the A7 is turned on. In case of power failure, the A7 will automatically switch to run from the internal battery supply. When AC power source is restored within the specified time, the battery supply begins recharging, and power is switched from battery to AC automatically to ensure continuous system use.

When power is lost for less than or equal to 60 s, the alarm settings prior to the power loss will be restored automatically.

The on-screen battery symbol indicates the battery status (see FIGURE 1-1).

PART(S)	DESCRIPTION
	Battery supply is fully charged. AC power is connected. The A7 is being powered by AC power.
	Battery supply is partially charged. AC power is connected and charging battery supply. The A7 is being powered by AC power. The solid portion represents the current charge level of the batteries in proportion to its maximum charge level.
	Battery supply is fully charged. AC power is not connected. The A7 is being powered by internal battery supply.
	Battery supply is partially charged. AC power is not connected. The A7 is being powered by internal battery supply.
	Battery supply has a low charge. Batteries need to be charged immediately to operate as a safe power backup. AC power is not connected. The A7 is being powered by internal battery supply.

---

PART(S)	DESCRIPTION
	Battery supply is not installed.

---

**FIGURE 1-1** Battery Status

If the battery capacity is too low, power supply failure will result. A high-level alarm will be triggered and the message **Low Battery Voltage!** will be displayed in the technical alarm area. In this case, apply AC power to the A7 Anesthesia System to resume operation and charge the battery supply.

### 1.1.12 Workplace Ergonomics

The A7 is a full-featured anesthesia delivery work station. The raised perimeter of its stainless steel work surface retains items that might otherwise roll or slide off its edge. The work surface light has high and low brightness settings. The wrap-around handle enables fine positioning of the machine. Three (3) large drawers are available for storage. All drawers can be locked with a key. Rail mounts on both sides of the machine enable mounting of patient monitors and most standard attachment arms for other devices. Non-slip footrest and central brake are provided. The top shelf can be used to mount additional equipment. An auxiliary work surface can be pulled out by depressing it inward when the drawer is closed.

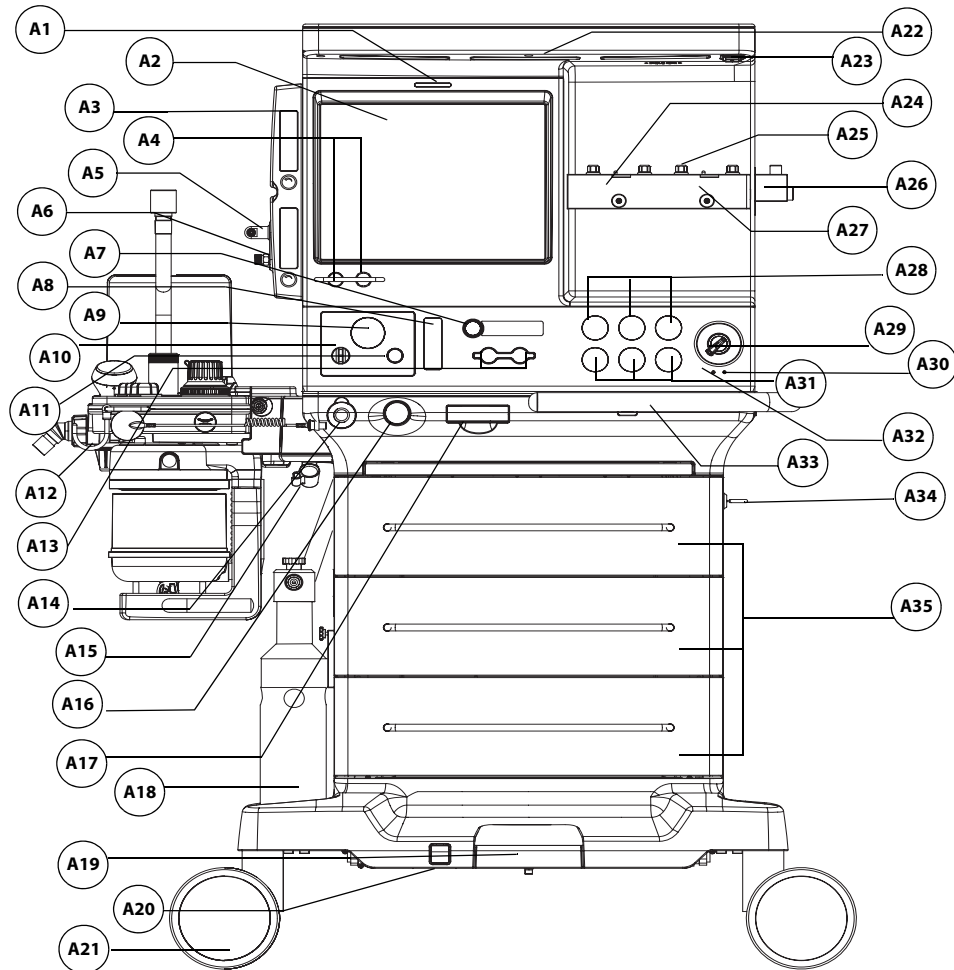
The operator of the A7 should be positioned in front of the monitor at a comfortable distance to view all displayed waveforms, text, and controls.

### 1.1.13 Hook

There is a hook located on the front of the breathing system that can be used to hang the tubes of the breathing circuit.

## 1.2 Physical Views

### 1.2.1 Main Unit (Front View)



**FIGURE 1-2** Main Unit (Front View)

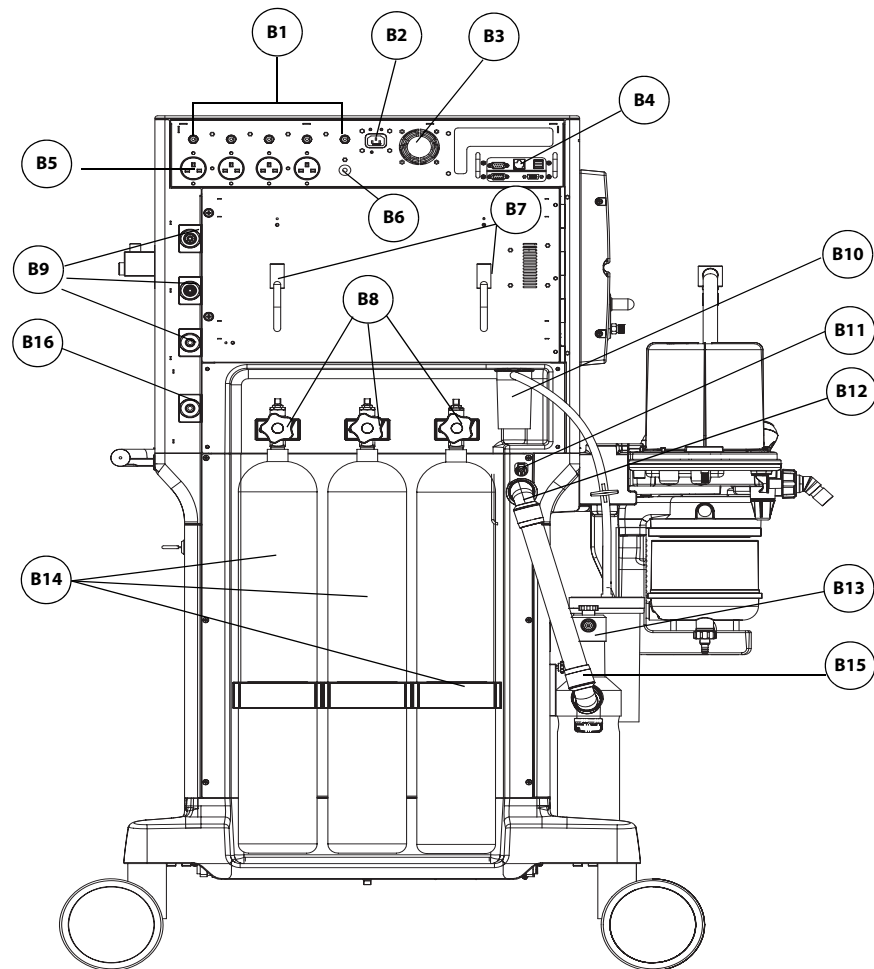
PART(S)	DESCRIPTION
<b>A1 Alarm Light</b>	Illuminates red, yellow, or cyan during an alarm condition to indicate the alarm priority. Red = high priority, Yellow = medium priority, Cyan = low priority, Off = no alarm condition.
<b>A2 LCD Touchscreen Display / System Interface</b>	See section "System Interface" on page 3-1
<b>A3 Auxiliary O<sub>2</sub>/Air Flowmeters</b>	Auxiliary O <sub>2</sub> /Air Flowmeters for auxiliary O <sub>2</sub> /Air output

<b>PART(S)</b>	<b>DESCRIPTION</b>
<b>A4 Electronic Flow Control System (EFCS) Flow or O<sub>2</sub> Concentration Control Knobs</b>	Turn the knob to adjust the flow or O <sub>2</sub> concentration.
<b>A5 Auxiliary O<sub>2</sub>/Air Gas Outlet</b>	Nozzle (barbed connector) for auxiliary O <sub>2</sub> /Air output. Combines the auxiliary O <sub>2</sub> /Air flowmeters into a single output of O <sub>2</sub> only, Air only, or O <sub>2</sub> /Air blend, depending upon the O <sub>2</sub> and Air flow adjustments.
<b>A6 Auxiliary O<sub>2</sub> Gas Power Outlet</b>	High pressure O <sub>2</sub> outlet for connecting external devices such as a jet ventilator.
<b>A7 Backup Flow Control System (BFCS) Button</b>	Push the button to deploy the BFCS.
<b>A8 Total Flow Meter</b>	Displays the combined flow rate of O <sub>2</sub> and Air.
<b>A9 Negative pressure gauge</b>	Indicates negative pressure value.
<b>A10 Selector switch</b>	Switches over between the working modes of the negative pressure suction device. It can be set to FULL, OFF, or REG. FULL indicates that the negative pressure suction device is working with the maximum pressure continuously and the adjustment knob does not function. OFF indicates that the negative pressure suction device is turned off and is not working. REG indicates that the negative pressure suction device works with the pressure adjusted through the negative pressure adjustment knob. Turn the knob counterclockwise to increase negative pressure and clockwise to decrease the negative pressure.
<b>A11 Negative pressure adjustment knob</b>	Adjusts the pressure of negative pressure suction device.
<b>A12 Hook</b>	Hang the tubes of the breathing system.
<b>A13 Backup Flow Control System (BFCS) Flow Control Knobs</b>	Air and O <sub>2</sub> gas dosing. Turn each knob counterclockwise to increase flow.
<b>A14 ACGO separate outlet</b>	Outputs the fresh gas.
<b>A15 Vacuum suction fixing clip</b>	Holds the tubes of the negative pressure suction device.
<b>A16 O<sub>2</sub> Flush Button</b>	Provides high flow O <sub>2</sub> to the inspiratory limb of the breathing system.
<b>A17 Touchpad</b>	Allows alternative control of the touch screen. Pull out to use.
<b>A18 AGSS</b>	Anesthetic Gas Scavenging System
<b>A19 Wheel Lock</b>	Locks or releases the brakes for all wheels when depressed.
<b>A20 Wheel Lock Indicator</b>	Displays a lock symbol in red background to indicate the wheels are locked, or an unlock symbol in green background to indicate the wheels are unlocked.
<b>A21 Wheels</b>	Casters to enable the A7 System to be moved. Casters on the A7 lock via a central brake.
<b>A22 Work Light</b>	Located under the top shelf to illuminate the work level shelf and allow the user to read the vaporizer dial setting in a dim light room.
<b>A23 Work Light Switch</b>	Turns on/off the work light. Three settings: Off, Low, and High. The user can turn on the work light only when the system switch is turned on.



<b>PART(S)</b>	<b>DESCRIPTION</b>
<b>A24 Vaporizer Mounting Manifold / Mounting Bar</b>	An interface for two/three Selectatec-type vaporizers to mount in this location. Bar holds two/three (optional) vaporizers. An interlock within the vaporizers provides for use of one vaporizer to deliver one agent at a time.
<b>A25 Vaporizer Mount Valve Cartridge</b>	Vaporizer index and outlet ports.
<b>A26 Vaporizer Parking Spot</b>	Holds a non-functional vaporizer for user convenience.
<b>A27 Vaporizer Locking Device</b>	Vaporizer locking mechanism to secure against accidental disconnection
<b>A28 Pressure Gauges (pipeline)</b>	Indicate the pressure at pipeline inlets for O <sub>2</sub> , Air, and N <sub>2</sub> O.
<b>A29 System Switch</b>	Switch to turn the system On or off.
<b>A30 AC Status LED</b>	Illuminated when the system is connected to an AC power source.
<b>A31 Pressure Gauges (cylinder)</b>	Indicate the pressure at cylinder inlets for O <sub>2</sub> , Air, and N <sub>2</sub> O.
<b>A32 Battery Charging LED</b>	Illuminated when the battery supply is charging.
<b>A33 Handle</b>	Metal bar used to assist moving the A7
<b>A34 Key lock</b>	Key and lock for securing the drawers
<b>A35 Storage Drawers</b>	Drawers (3) for storage (lockable)

## 1.2.2 Main Unit (Rear View)

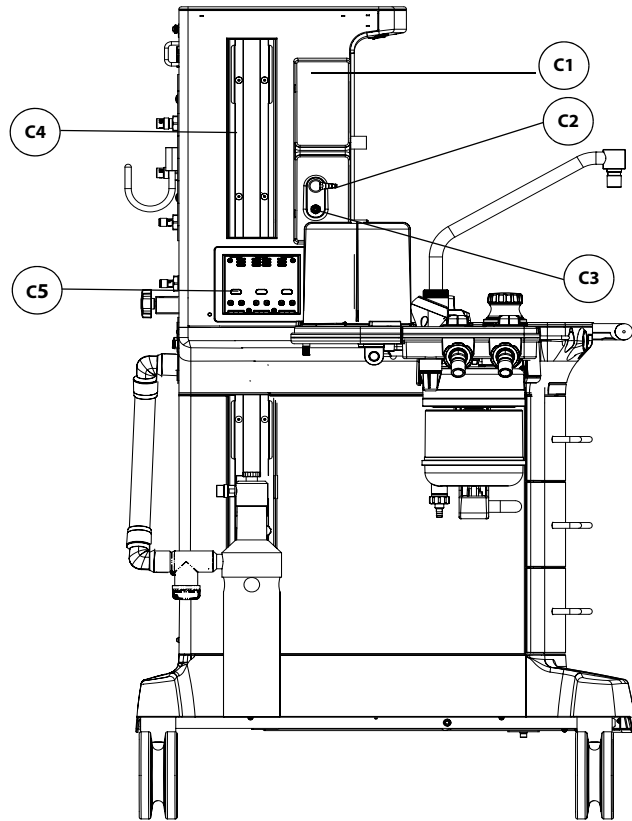


**FIGURE 1-3** Main Unit (Rear View of Standard Cylinder)

PART(S)	DESCRIPTION
<b>B1</b> <b>Circuit Breakers</b>	Breakers for each auxiliary outlet 3 A each (quantity 4), 10 A total (quantity 1)
<b>B2</b> <b>Mains Inlet</b>	Connects the mains power cord
<b>B3</b> <b>Exhaust Fan</b>	Forces air to cool electronics and prevent buildup of O <sub>2</sub> concentration. Do not block.

PART(S)	DESCRIPTION
<b>B4 Communication Ports</b>	SP1, DP1, CS1, SB1, SB2, VGA Port (see section 9.6.4 (page 9-7) "Communication Ports").  <b>CAUTION: Do not connect any devices to the SB ports other than Mindray approved USB storage devices and a supported USB mouse(See "Networking and USB Storage" on page A-4.).</b>
<b>B5 Auxiliary AC Outlets</b>	Additional devices up to a total maximum power of 10 amps can be connected to four (4) outlets. The A7 outlets are covered with two (2) metal plates, and require a tool to access. Only authorized personnel can access these outlets.
<b>B6 Equipotential stud / lug</b>	Provides a ground point. Eliminates the ground potential difference between different devices to ensure safety.
<b>B7 Hooks</b>	Allows user to hang or wrap cords
<b>B8 Cylinder Supply Connections</b>	Interface connectors to high pressure supply tanks (O <sub>2</sub> , Air, and N <sub>2</sub> O)
<b>B9 Gas Pipeline Supply Connections</b>	Connections for O <sub>2</sub> , Air, and N <sub>2</sub> O from a pipeline gas supply
<b>B10 Overfill Protection</b>	Prevents the fully collected waste liquid from flowing backward to ensure the tubing safety.
<b>B11 Sample Line Exhaust Gas Inlet</b>	Inlet for exhaust gas from gas module. The exhaust gas will be fed back into the breathing system.
<b>B12 AGSS Connector</b>	Connects the AGSS or waste gas disposal system
<b>B13 AGSS</b>	Anesthetic Gas Scavenging System
<b>B14 Cylinders</b>	Supply tanks (E-size) containing high pressure O <sub>2</sub> , Air, and N <sub>2</sub> O to act as backup supply if the pipeline pressure is removed.  <b>NOTE: Tanks not supplied by Mindray.</b>
<b>B15 AGSS Transfer Hose</b>	Routes exhaust gases from main unit to scavenger.
<b>B16 Negative pressure supply connection</b>	Connects to the negative pressure supply on the hospital's walls.

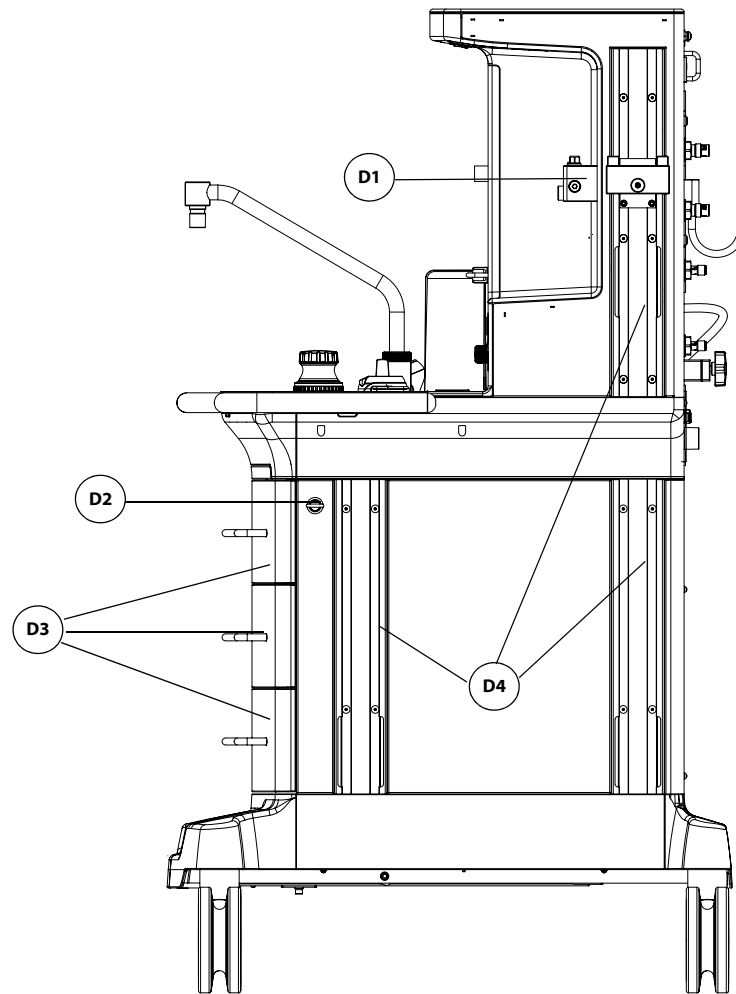
### 1.2.3 Main Unit (Left View)



**FIGURE 1-4** Main Unit (Left View)

PART(S)	DESCRIPTION
<b>C1 Auxiliary O<sub>2</sub>/Air Flowmeters</b>	Auxiliary O <sub>2</sub> /Air Flowmeters for auxiliary O <sub>2</sub> /Air output
<b>C2 Auxiliary O<sub>2</sub>/Air Gas Outlet</b>	Nozzle (barbed connector) for auxiliary O <sub>2</sub> /Air output. Combines the auxiliary O <sub>2</sub> /Air flowmeters into a single output.
<b>C3 Auxiliary O<sub>2</sub> Gas Power Outlet</b>	High pressure O <sub>2</sub> outlet (DISS connector) for connecting external devices such as a jet ventilator.
<b>C4 Rail Mount</b>	Enables mounting of patient monitors and most standard attachment arms for other devices. Rail mounts are on both left and right sides of the A7.
<b>C5 Module slot</b>	AG module mentioned in this manual can be inserted into the slot and identified.

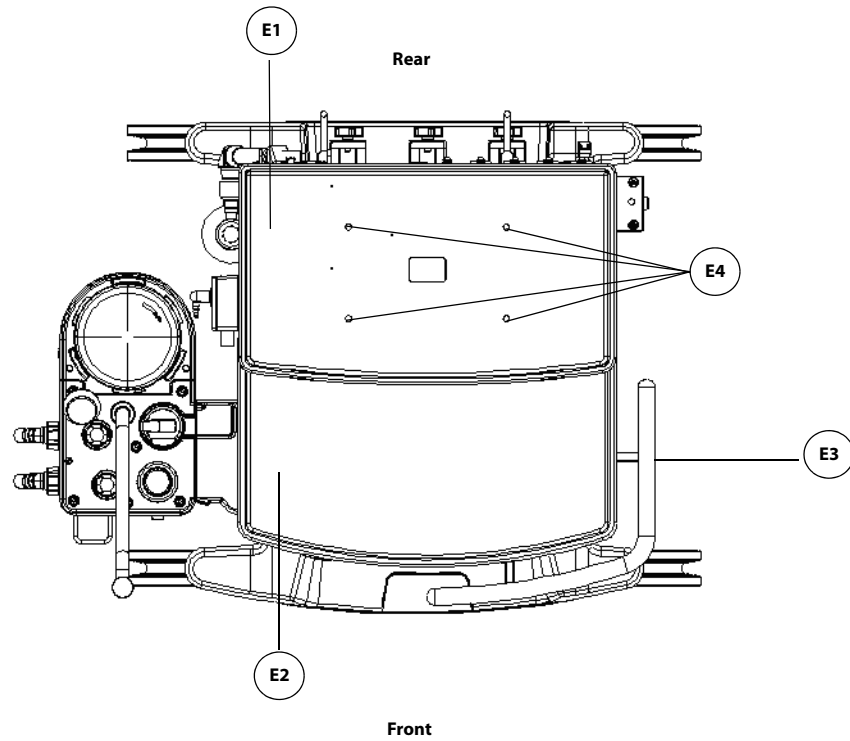
## 1.2.4 Main Unit (Right View)



**FIGURE 1-5** Main Unit (Right View)

PART(S)	DESCRIPTION
<b>D1 Vaporizer Mounting Manifold / Mounting Bar</b>	An interface for two/three Selectatec-type vaporizers to mount in this location. Bar holds two/three (optional) vaporizers. An interlock within the vaporizers provides for use of one vaporizer to deliver one agent at a time.
<b>D2 Key Lock</b>	Key and lock for securing the drawers
<b>D3 Storage Drawers</b>	Drawers (3) for storage (lockable)
<b>D4 Rail Mount</b>	Enables mounting of patient monitors and most standard attachment arms for other devices. Rail mounts are on both left and right sides of the A7.

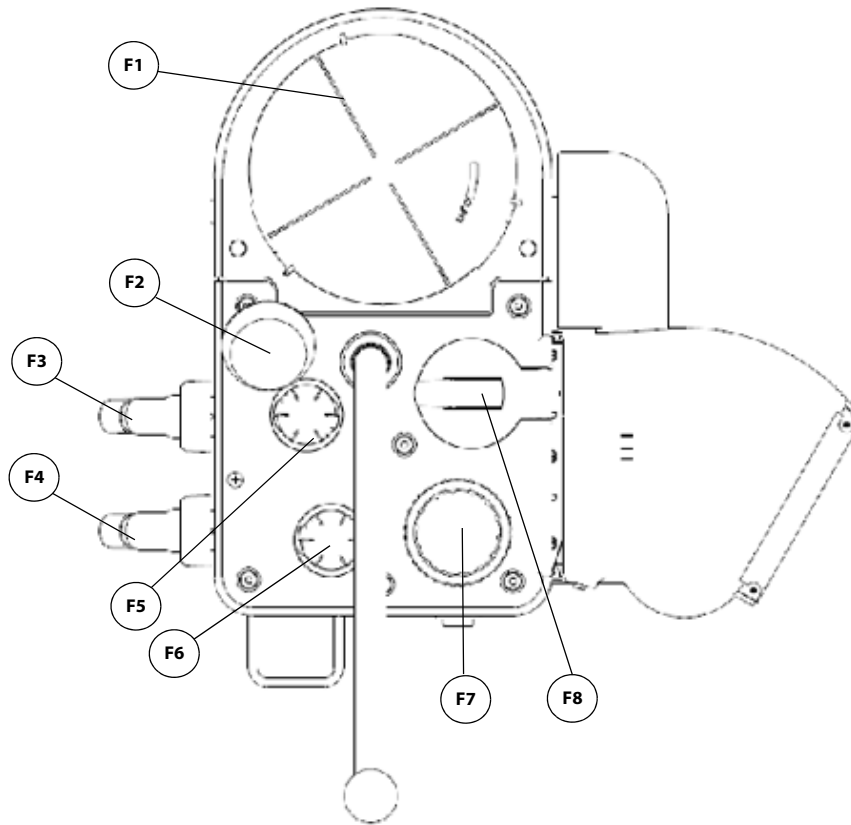
## 1.2.5 Main Unit (Top View)



**FIGURE 1-6** Main Unit (Top View)

PART(S)	DESCRIPTION
<b>E1</b> <b>Top Shelf</b>	Top level surface
<b>E2</b> <b>Work Level Shelf</b>	Work Level surface (stainless steel)
<b>E3</b> <b>Handle</b>	Wrap-around metal bar used to assist moving the A7 device
<b>E4</b> <b>Mounting Holes</b>	Allows mounting of optional equipment to the top shelf (i.e., DPM6 and DPM7 mounting plates and kits (see section A.7 (page A-3) "Mounting Accessories").

## 1.2.6 Breathing System (Top View)



**FIGURE 1-7** Breathing System (Top View)

PART(S)	DESCRIPTION
<b>F1</b> <b>Bellows (including bellows dome)</b> <sup>1</sup>	Bellows that separates the breathing system gases from the oxygen drive gas
<b>F2</b> <b>PAW Gauge</b> <sup>2</sup>	Indicates the patient airway pressure
<b>F3</b> <b>Expiratory Limb</b>	Exhaled breathing circuit connection
<b>F4</b> <b>Inspiratory Limb/ACGO common outlet</b>	Inhaled breathing circuit connection
<b>F5</b> <b>Expiration Check Valve</b>	Allows flow of expiratory gas from the patient to the re-breathing system, and prevents reverse flow.
<b>F6</b> <b>Inspiration Check Valve</b>	Allows flow of inspiratory gas to the patient, and prevents reverse flow.

<sup>1</sup> The bellows dome is a transparent cover with graduation marks from 300 to 1500 ml. These marks are for reference only. Tidal volume (V<sub>t</sub>) should be read exclusively from the display of the user interface. Delivered V<sub>t</sub> is a combination of bellows displacement and fresh gas flow.

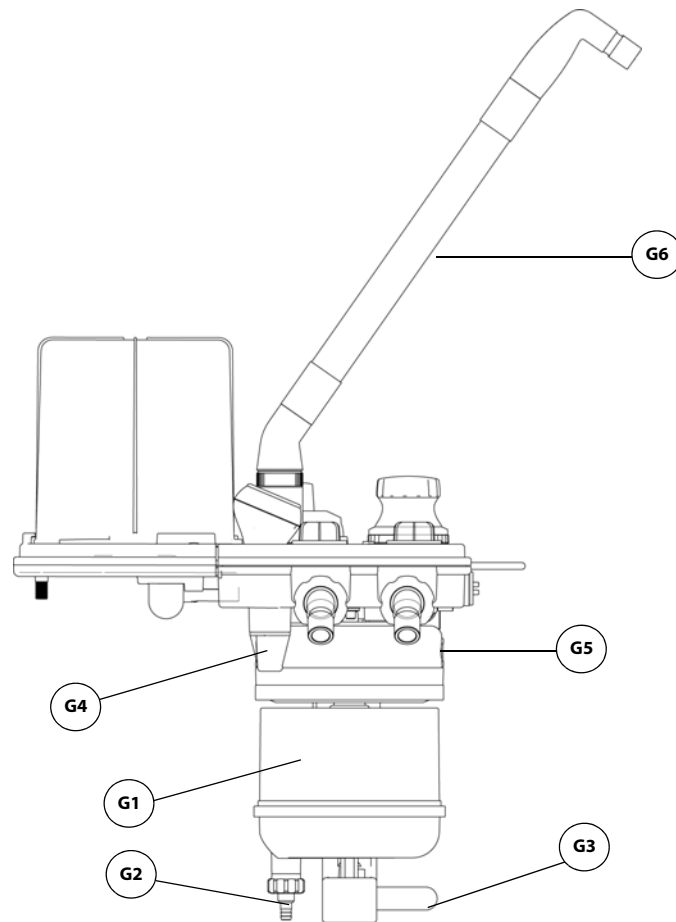
<sup>2</sup> The APL valve and PAW gauge numerics are for reference only. Calibrated patient airway pressure is displayed on the user interface.

PART(S)	DESCRIPTION
<b>F7 Quick Release APL Valve<sup>2</sup></b>	Rotary regulator for setting the breathing system pressure limit during manual ventilation. Its scale shows approximate pressure. Set to SP during Spontaneous breathing. When necessary, lift the APL valve upward to release pressure quickly.
<b>F8 Auto/Manual ventilation Switch</b>	Enables switching between Automatic and Manual ventilation modes

<sup>1</sup> The bellows dome is a transparent cover with graduation marks from 300 to 1500 ml. These marks are for reference only. Tidal volume (Vt) should be read exclusively from the display of the user interface. Delivered Vt is a combination of bellows displacement and fresh gas flow.

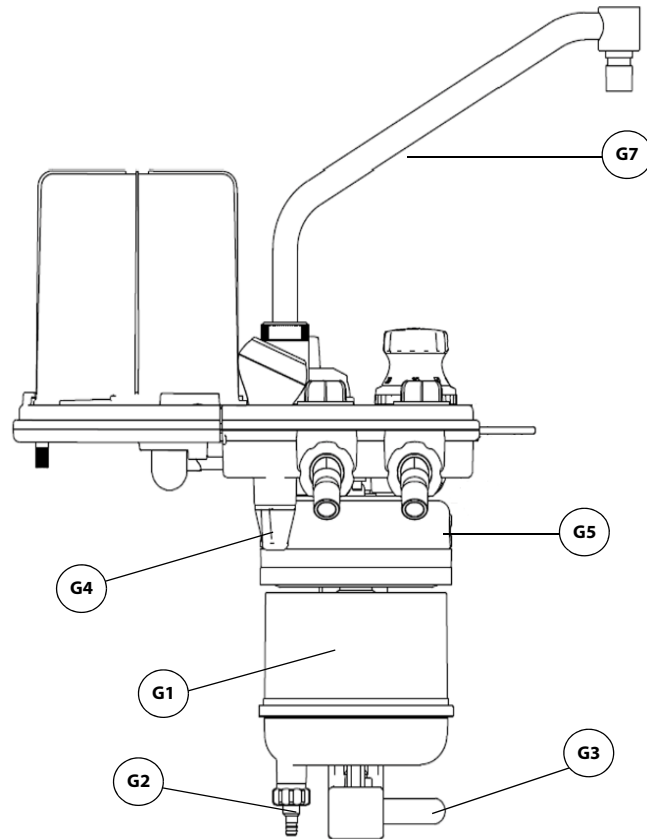
<sup>2</sup> The APL valve and PAW gauge numerics are for reference only. Calibrated patient airway pressure is displayed on the user interface.

## 1.2.7 Breathing System (Left View)



**FIGURE 1-8** Breathing System (Left View, the Flexible Bag Arm (optional))

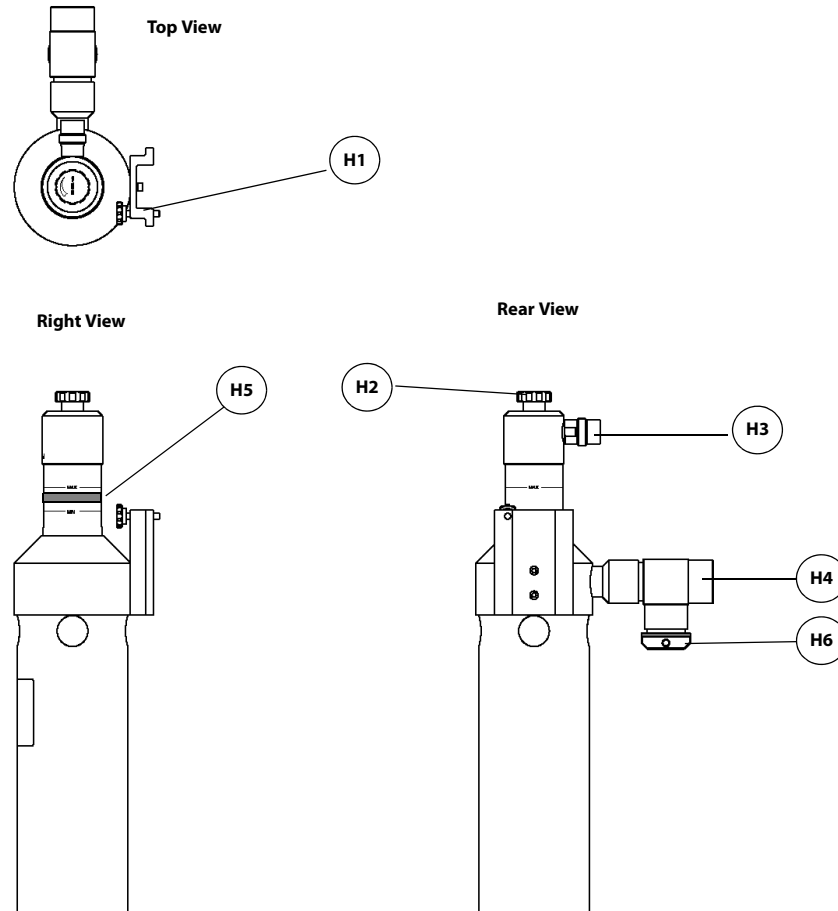




**FIGURE 1-9** Breathing System (Left View, the Fixed Height Bag Arm (standard))

PART(S)	DESCRIPTION
<b>G1</b> <b>CO<sub>2</sub> Absorber Canister</b>	Container for CO <sub>2</sub> absorbent material loose fill or Pre-Paks)
<b>G2</b> <b>Condensate Drain Valve</b>	Turn counter-clockwise (looking from bottom) to drain water collected in the absorber canister.
<b>G3</b> <b>Absorber Canister Lock</b>	Lever-type locking mechanism to lock (horizontal position) or unlock (vertical position) the absorber canister from the canister assembly.
<b>G4</b> <b>Water Trap</b>	Accumulates condensate from the breathing system. Must be removed and emptied periodically. To remove, turn clockwise (looking from top).
<b>G5</b> <b>Absorber Bypass Assembly</b>	Maintains pressure in the breathing circuit when changing the soda lime contents in the CO <sub>2</sub> absorber canister.
<b>G6</b> <b>Flexible Bag Arm</b>	Provides the interface with the manual ventilation bag. The flexible bag arm can be adjusted to desired height and the bag port can be rotated 360°.
<b>G7</b> <b>Fixed Height Bag Arm</b>	Provides the interface for the manual ventilation bag. The height of fixed bag arm cannot be adjusted and the bag port is in a fixed direction.

## 1.2.8 Active Anesthetic Gas Scavenging System (AGSS) (Top, Right, and Rear Views)

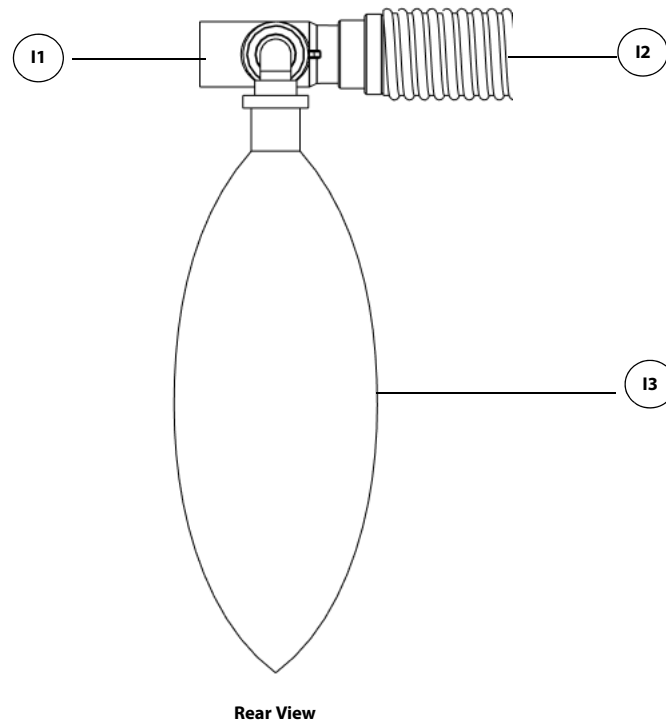


**FIGURE 1-10** Active AGSS (Top, Right, and Rear Views)

PART(S)	DESCRIPTION
<b>H1 Mounting Rail Attachment</b>	Allows the AGSS to be mounted on the side rail. Contains a thumbscrew that must be tightened against the mounting rail.
<b>H2 Flow Adjust Knob</b>	Turn clockwise or counter-clockwise to adjust the flow in the AGSS until the float is between Min and Max marks.
<b>H3 Exhaust Port</b>	Exhaust port to the hospital's waste gas scavenging system
<b>H4 Inlet Port</b>	Intake for exhaust gases from the breathing system. An AGSS transfer hose connects the Inlet and AGSS ports (see FIGURE 1-3) to transfer the exhaust gases.

PART(S)	DESCRIPTION
<b>H5 Float</b>	Indicates exhaust flow. Adjusted by turning the Flow Adjust Knob (H2) until the float is between the Min and Max marks.
<b>H6 Inlet Port Cover</b>	The inlet port is used to connect ACGO circuits that require gas scavenging to the AGSS.
<b>CAUTION: Keep the inlet port cover closed when the ACGO circuit is not used.</b>	

### 1.2.9 Passive Anesthetic Gas Scavenging System (AGSS) (Right View)



**FIGURE 1-11** Passive AGSS (Right View)

PART(S)	DESCRIPTION
<b>I1 Inlet Port</b>	Intake for exhaust gases from the breathing system connecting with the AGSS ports.
<b>I2 Exhaust Port</b>	Exhaust port to the hospital's waste gas scavenging system.
<b>I3 Manual Bag</b>	When the manual bag is inflated, it indicates that the passive AGSS is blocked.

## 1.2.10 Negative Pressure Suction Device



**FIGURE 1-12** Negative Pressure Suction Device

PART(S)	DESCRIPTION
J1 <b>Overfill Protection</b>	Prevents the fully collected waste liquid from flowing backward to ensure the tubing safety.
J2 <b>Negative pressure gauge</b>	Indicates negative pressure value.
J3 <b>Negative pressure adjustment knob</b>	Adjusts the pressure of negative pressure suction device.
J4 <b>Selector switch</b>	Switches over between the working modes of the negative pressure suction device. It can be set to FULL, OFF, or REG. FULL indicates that the negative pressure suction device is working with the maximum pressure continuously that is taken from the wall and the adjustment knob does not function. OFF indicates that the negative pressure suction device is turned off and is not working. REG indicates that the negative pressure suction device works with the pressure adjusted through the negative pressure adjustment knob. Turn the knob counterclockwise to increase negative pressure and clockwise to decrease the negative pressure.

# **Installation**

---

Unpacking.....	2-3
Initial Setup.....	2-4
Install the Vaporizer.....	2-5
Install the Suction Canister.....	2-8

- WARNING:** This equipment must be installed by a factory authorized representative.
- WARNING:** Continuous use of desiccated soda lime may endanger patient safety. Adequate precautions should be taken to ensure that the soda lime in the CO<sub>2</sub> absorbent canister does not become desiccated. Turn off all gases when finished using the system.
- WARNING:** When electrosurgical equipment is used, keep the electrosurgical leads away from the breathing system, and other parts of the A7 Anesthesia System. Keep available backup manual ventilation and a respirator with mask in case the electrosurgical equipment prevents safe use of the ventilator. Ensure the correct operations of all life support and monitoring equipment.
- WARNING:** Do not use masks or breathing tubes that are antistatic or conductive. They can cause burns if they are used near high frequency electrosurgical equipment.
- WARNING:** This A7 Anesthesia System has waste gas exhaust ports. The operator of the machine should pay attention to the disposal of the residual breathing gas scavenged.
- CAUTION:** The operational environment and the power source of the equipment must comply with the requirements as specified in the A7 "Product Specifications" on page 9-1.

## 2.1 Unpacking

When the A7 Anesthesia System is delivered, IMMEDIATELY inspect the box for any damage.

- a.** If there is NO damage and ALL tip indicators on the box exterior are intact, then sign and date the bill of lading or airway bill to indicate safe receipt of the A7.
- b.** If there is DAMAGE or ANY of the tip indicators on the box exterior have been activated, then conditionally accept the delivery and clearly describe the damages on the bill of lading or airway bill. BOTH the carrier and recipient must sign and date the bill of lading or airway bill. Save all damaged factory packaging until further instructed by Mindray. The receiver should immediately contact Mindray Customer Service at (800) 288-2121 or (201) 995-8000.

## 2.2 Initial Setup

The initial setup of the A7 Anesthesia System must be performed by an authorized Mindray service representative. Please contact Mindray Technical Support for any additional assistance.

**NOTE:**        **The A7 is intended to be operated with an external CO2 monitor complying with ISO 80601-2-55. Connection to the CO2 monitor should be via a sample line from the patient circuit.**



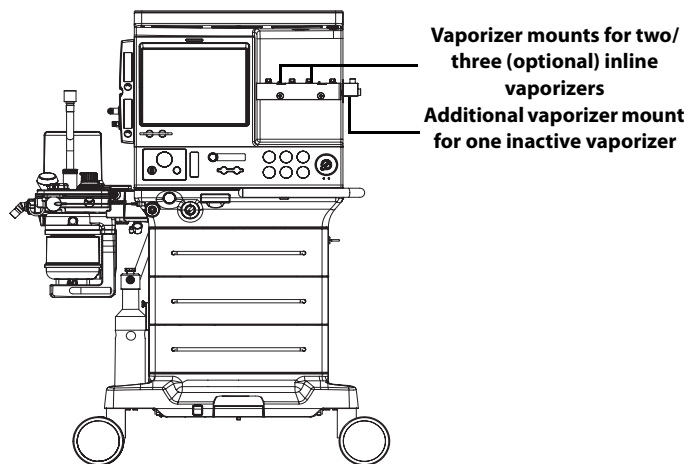
## 2.3 Install the Vaporizer

**CAUTION:** Only use vaporizers with Selectatec Interlock Systems with the A7 unit.

**WARNING:** Use vaporizers compliant to ISO 80601-2-13. See section A.9 (page A-4) "Vaporizers". Refer to the vaporizer manufacturer's Instructions For Use for mounting, filling, or draining the vaporizer and other information.

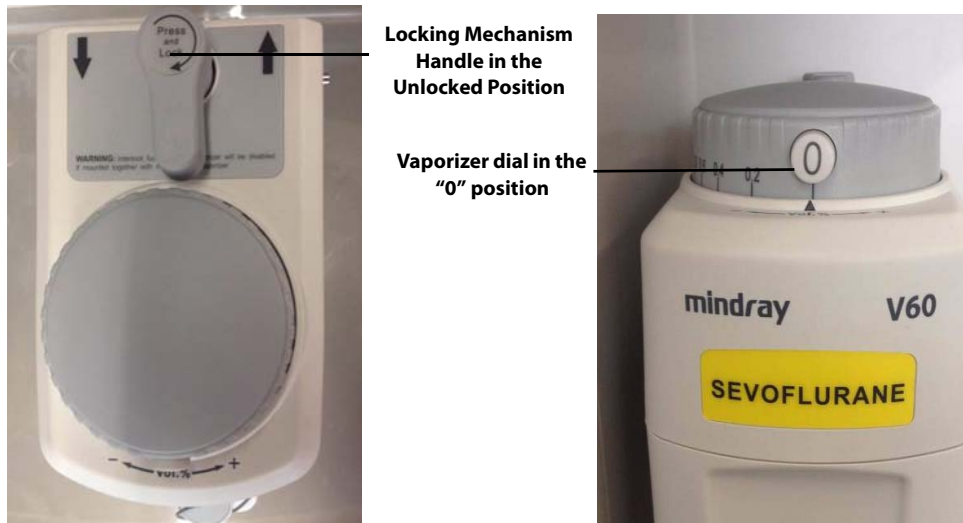
**WARNING:** Use care in lifting and manipulating vaporizers during the mounting process as their weight may be greater than expected, based on their size and shape.

**NOTE:** The barometric pressure may differ from the calibration pressure of the anesthetic vaporizer. This may cause an inaccurate output of the anesthetic agent. The operator should continuously monitor the concentration of anesthetic agent during system use to determine if the output concentration is accurate.



**FIGURE 2-1** Location of Vaporizer Mounting System

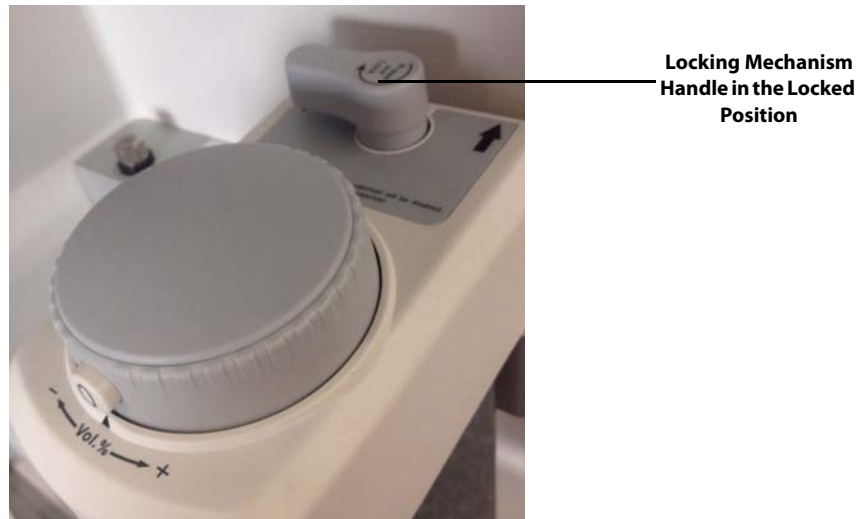
1. If replacing and removing the vaporizer, lift each vaporizer straight up off the manifold. Do not pull the vaporizer forward. Do not rotate the vaporizer on the manifold.
2. Align the new vaporizer over the valve cartridges of the mounting bar, slightly tilting back the vaporizer. Hang the vaporizer on the mounting bar (see FIGURE 2-2). Ensure that the locking mechanism handle is in the unlocked position. Ensure that the dial is in the "0" (Transport) position or equivalent, depending upon the vaporizer manufacturer's Instructions For Use.



**FIGURE 2-2** Vaporizer, Unlocked

3. Rotate the locking mechanism handle clockwise into the locked position (see FIGURE 2-3).

**NOTE:** If installing a desflurane vaporizer, refer to the manufacturer's Instructions For Use on installation and use of the vaporizer.



**FIGURE 2-3** Vaporizer, Locked

4. Final check:
  - a. Ensure that the top of the vaporizer is horizontal. If not, remove and reinstall the vaporizer.
  - b. If a vaporizer lifts off the manifold, repeat steps 1 through 3 to reinstall the vaporizer. If the vaporizer lifts off a second time, do not use the system.

**WARNING:** For the A7 Anesthesia System, using or turning on more than one vaporizer simultaneously is prohibited and prevented by a mechanical interlock. Do not attempt to override this safety mechanism.

### 2.3.1 Filling and Draining the Vaporizer

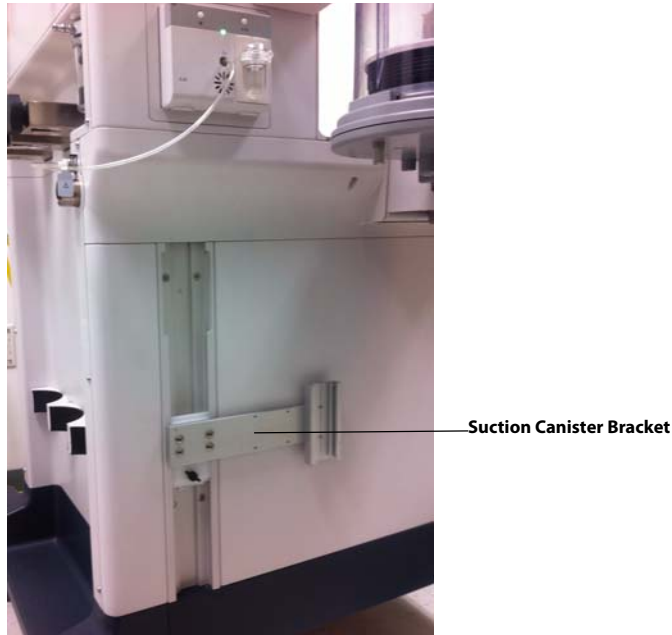
Install the vaporizers with a Selectatec interlock system that are compliant to ISO 80601-2-13 on the A7 unit. See section A.9 (page A-4) "Vaporizers". Refer to the vaporizer manufacturer's Instructions For Use for filling or draining the vaporizer and other information.

**WARNING:** Ensure that the correct anesthetic agent is used. The vaporizer is designed with the specific anesthetic agent named on it and further indicated by color coded labelling. The concentration of the anesthetic agent actually output will vary if the vaporizer is filled with the wrong agent.

**WARNING:** Do not reuse the agent drained from the vaporizer. Treat as a hazardous chemical and follow local regulations for proper disposal.

## 2.4 Install the Suction Canister

1. Place the liquid collection bottles into the suction canister bracket. Install the suction tube and the filter based on the printed illustration on the liquid collection bottle.
2. Insert the suction tube onto the overfill protection connector.



**FIGURE 2-4** Install the Suction Canister

**WARNING:** When turning the Vacuum Regulator to "REG" from "FULL" or "OFF", the vacuum level will return to its previously regulated setting. Vacuum may be set at improper level for procedure.

**WARNING:** ALWAYS confirm vacuum setting prior to performing procedure.

**WARNING:** The vacuum CANNOT be regulated when the selector knob is set to the "FULL" position.

**WARNING:** When the selector knob is set to the "FULL" position, the vacuum pressure is the same as the external vacuum applied.

**WARNING:** The suction shall be used with a suction catheter.

**NOTE:** When installing the filter onto the suction tube, note to allow the filter side with printed "IN" to face the liquid collection bottle.

### REGULATE MODE

Turn selector knob fully clockwise to the regulator mode and confirm vacuum setting before use.

### FULL MODE

Turn selector knob fully counterclockwise to the full mode and confirm vacuum setting before use.

### 2.4.1 Turn On the Vacuum Regulator

1. Assemble the negative pressure suction device.
2. Occlude the suction tube inlet at the patient end.
3. Turn on the negative pressure pipeline supply.
4. Set the negative pressure suction selector switch to **REG**.
5. Adjust the negative pressure adjustment knob to cause the reading on the pressure gauge to be greater than -40 kPa.

### 2.4.2 Turn Off the Negative Pressure Suction Device

Switch the negative pressure suction selector to **OFF** to turn off the negative pressure suction device.

**WARNING:** Keep the negative pressure suction switch in **OFF** status when not in use.

**This page intentionally left blank.**

# System Interface

---

Main Screen Components .....	3-2
System Information Header .....	3-4
Fresh Gas Flow Display .....	3-9
Waveforms Tab .....	3-16
Spirometry Tab .....	3-18
Demographics Tab.....	3-24
Ventilation Mode Tabs .....	3-25
Measured Values Area.....	3-27
System Softkeys.....	3-28
List Trends.....	3-28
General Tab.....	3-36
Display Tab.....	3-38
System Tab.....	3-42
Service Tab.....	3-49

## 3.1 Main Screen Components

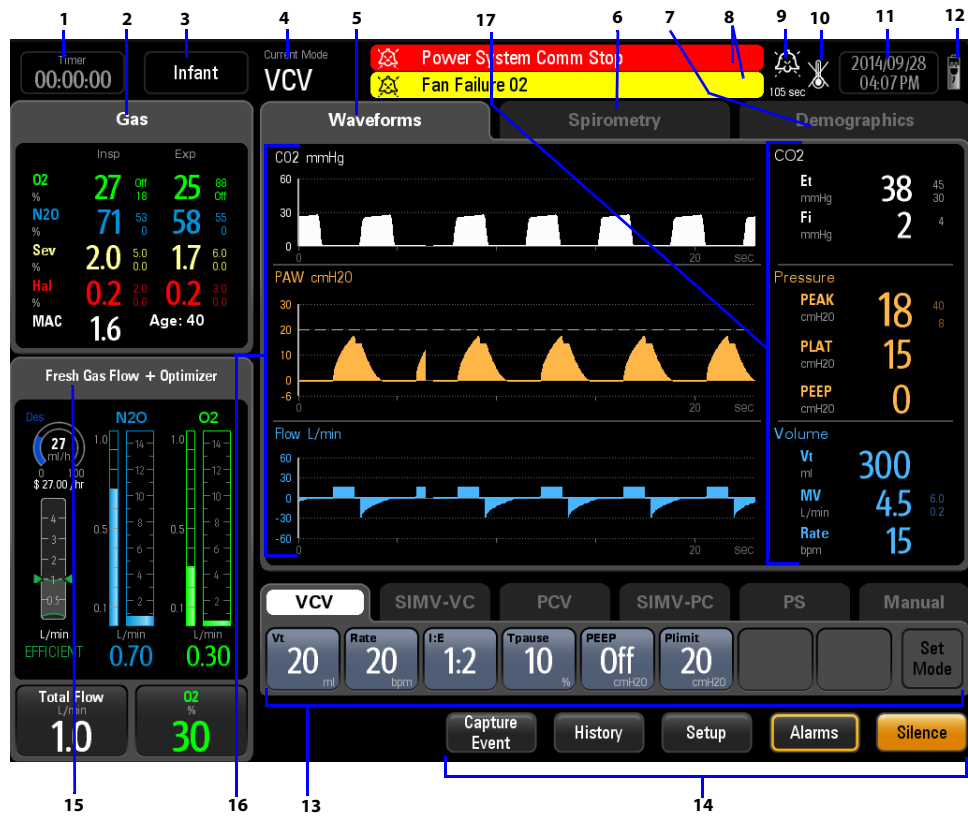


FIGURE 3-1 A7 Main Screen Components

NUMBER	MAIN SCREEN COMPONENT	DESCRIPTION
1	Elapsed / Countdown Timer	Displays elapsed time or countdown time. Select to start, stop, or reset the timer.
2	Gas Area	Displayed when AG module is connected. Displays realtime inspiratory and expiratory levels of gas.
3	Patient Size	Displays the currently selected patient size (Adult, Pediatric, or Infant). Select to change the patient size when the A7 is in the Standby mode, Manual mode or Monitor* mode.
4	Current Ventilation Mode	Displays the current ventilation mode (VCV, SIMV-VC, PCV, SIMV-PC, PS, Manual, Bypass, ACGO, Monitor, or Standby.)
5	Waveforms Tab	See "Waveforms Tab" on page 3-16.
6	Spirometry Tab	See "Spirometry Tab" on page 3-18.
7	Demographics Tab	See "Demographics Tab" on page 3-24.

\* Monitor mode is only available with the AG module.



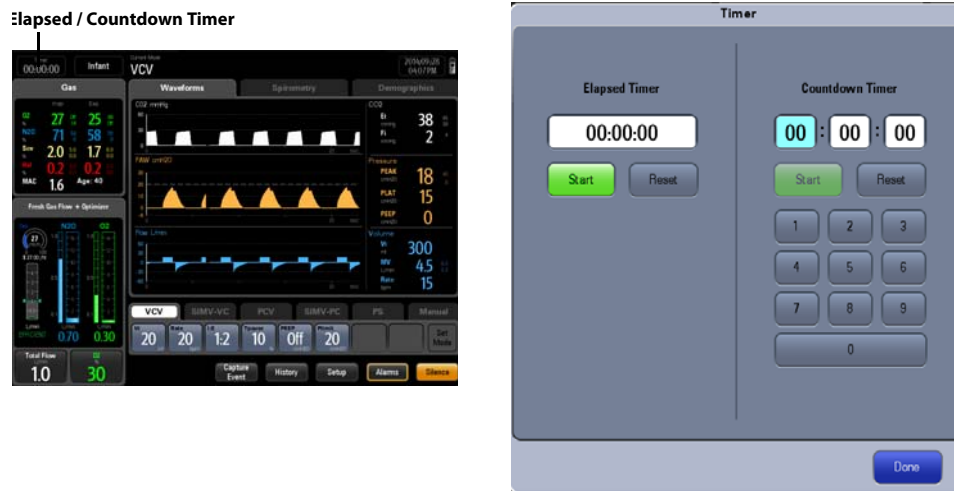
NUMBER	MAIN SCREEN COMPONENT	DESCRIPTION
8	Alarm / Prompt Message Area	<p>Displays physiological alarms, technical alarms, and prompt messages. The most recent highest priority alarm is displayed at the top.</p> <p>The remaining alarms are displayed in the lower area and grouped by priority. The most recent of these alarms is displayed first. Select this area to display a list of all Active Alarms.</p> <p>See "Alarms and Messages" on page 6-1 for tables that list the individual messages and their associated priority levels. High priority messages are red. Medium priority messages are yellow. Low priority messages are cyan. Prompt messages are white.</p>
9	Alarm Silence Icon	Displays the alarm silence icon and Alarm Silence countdown timer for 120 seconds when the Silence softkey is selected.
10	Breathing System Warmer Icon	Indicates the warmer is not active.
11	System Date and Time	Displays the current system date and time. Select to adjust the date and time. See "Date and Time" on page 3-7.
12	Main Power Supply and Battery Status Icon	Displays the main power supply and battery state. See "Power Management / Battery Supply" on page 1-6.
13	Ventilations Mode and Setting Parameters Area	Displays tabs for all ventilation modes (VCV, SIMV-VC, PCV, SIMV-PC, PS, and Manual). Each tab displays the ventilation mode and its parameters. Select a tab and the "Set Mode" softkey to change the ventilation mode. Select a parameter button to change the parameter setting. See "Ventilation Modes" on page 5-7.
14	System Softkeys	<p><b>History</b> - Select to open the History menu. The History menu contains the List Trends and Event log.</p> <p><b>Capture Event</b> - Select to capture an event and record it in the event log.</p> <p><b>Setup</b> - Select to open the Setup menu. The Setup menu contains the General tab, Display tab, System tab, and Service tab.</p> <p><b>Alarms</b> - Select to open the Alarms menu to set alarm limits, set alarm volume, and view all active alarms.</p> <p><b>Silence</b> - Select to silence all currently sounding alarm tones for 120 seconds. The alarm silence icon and 120 second countdown time appear at the top of the screen. Select again to clear the alarm silence. Note, however, that a new alarm will sound if that alarm occurs while the system is in a silenced state. If this occurs, you can select the Silence softkey again to silence the new alarm and reset the silence countdown timer to 120 seconds.</p>
15	Fresh Gas Flow + Optimizer® Area	Displays real-time agent usage per hour, cost per hour, flowmeter levels for O <sub>2</sub> and balance gas.
16	Waveforms/Spirometry Area	Displays waveforms or spirometry.
17	Monitored Parameter Area	Displays monitored parameters.

\* Monitor mode is only available with the AG module.

## 3.2 System Information Header

### 3.2.1 Elapsed / Countdown Timer

Displays the elapsed time, countdown time, or both. Located at the top left of the main screen. Select the timer icon to open the **timer** menu (see FIGURE 3-2).



**FIGURE 3-2** Elapsed / Countdown Timer

#### Elapsed Timer

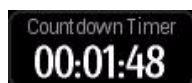
Select the **Start** button to turn on the elapsed timer (see FIGURE 3-3). Select the **Stop** button to pause the elapsed timer and the timer will flash. Select the **Reset** button to turn off the elapsed timer.



**FIGURE 3-3** Only Elapsed Timer Screen

#### Countdown Timer

Input the time with the keypad and select the **Start** button to turn on the countdown timer (see FIGURE 3-4). Select the **Stop** button to pause the countdown timer and the timer will flash. Select the **Reset** button to turn off the countdown timer.



**FIGURE 3-4** Only Countdown Timer Screen

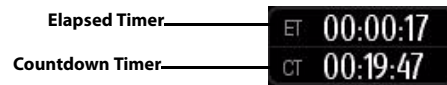
When the countdown timer is expired, the system will pop-up a warning dialog (see FIGURE 3-5) and provide a notification sound at the same time. The sound will repeat until the **Done** button is pressed.



**FIGURE 3-5** Countdown Timer Expired

### Elapsed and Countdown Timer

Turn on both the elapsed and countdown timer, the figure below displays on the screen (see FIGURE 3-6).



**FIGURE 3-6** Elapsed and Countdown Timer Screen

## 3.2.2 Patient Size

Displays the currently selected patient size (Adult, Pediatric, or Infant). Select to change the patient size when the A7 is in **Standby** mode, **Manual** mode or **Monitor** mode (available with the AG module) (see FIGURE 3-7).



**FIGURE 3-7** Patient Size Menu

## 3.2.3 Alarm and Prompt Messages

Displays physiological alarms, technical alarms, and prompt messages. The most recent highest priority alarm is displayed at the top.

The remaining alarms are displayed in the lower area and grouped by priority. The most recent of these alarms are displayed first.

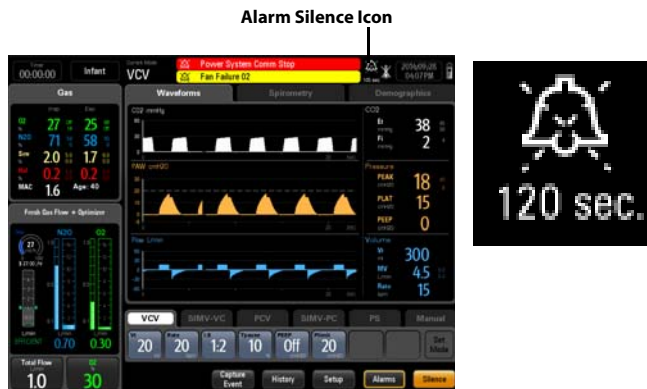
Select this area to display a list of all Active Alarms. See "Alarms and Messages" on page 6-1 for tables that list the individual messages and their associated priority levels. High priority messages are red. Medium priority messages are yellow. Low priority messages are cyan. Prompt messages are white (see FIGURE 3-8).



**FIGURE 3-8** Alarm and Prompt Messages

### 3.2.4 Alarm Silence Icon

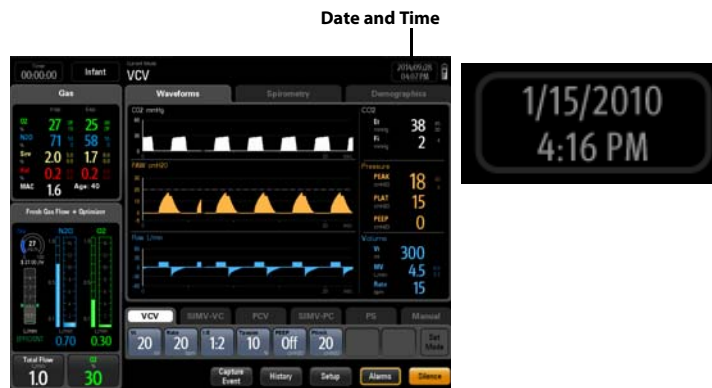
The Alarm Silence icon and Alarm Silence countdown timer are displayed after selecting the **Silence** softkey, which indicates that all currently sounding alarms are silenced for 120 seconds (see FIGURE 3-9).



**FIGURE 3-9** Alarm Silence Icon

### 3.2.5 Date and Time

Displays the current system date and time (see FIGURE 3-10).



**FIGURE 3-10** Date and Time Icon

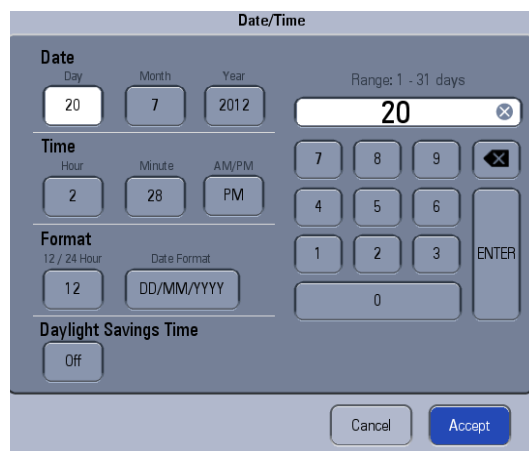
To adjust the date and time:

1. Select the Date and Time icon. The Date/Time dialog is displayed (see FIGURE 3-11).
2. Use the dialog keypad and softkeys to adjust the date, time, 12/24 hour format, date format, and daylight savings time.

**NOTE:** If applicable, select **Daylight Savings Time** first before all other settings.

**NOTE:** If the **Daylight Savings Time On/Off** button in the **Date/Time** dialog (see FIGURE 3-11) is disabled and cannot be selected, it is because the **Daylight Savings** setting has been set to **Auto** in the **System settings** (see TABLE 3-10 on page 3-42).

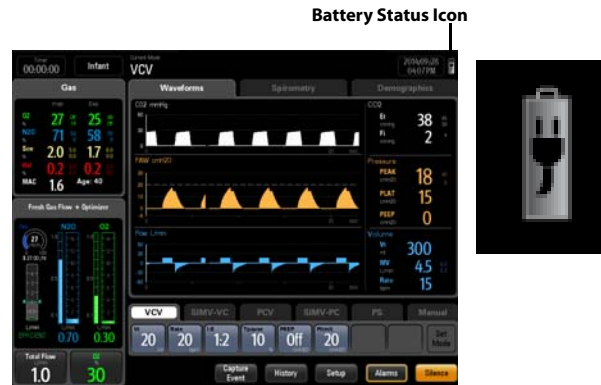
3. Select **Accept** to finalize your changes.



**FIGURE 3-11** Date and Time Menu

### 3.2.6 Battery Status

Displays the main power supply and battery state (see FIGURE 3-12). For more information on the A7 advanced power management system, see “Power Management / Battery Supply” on page 1-6.



**FIGURE 3-12** Battery Status Icon

PART(S)	DESCRIPTION
	Battery supply is fully charged. AC power is connected. The A7 is being powered by AC power.
	Battery supply is partially charged. AC power is connected and charging batteries. The A7 is being powered by AC power. The solid portion represents the current charge level of the batteries in proportion to its maximum charge level.
	Battery supply is fully charged. AC power is not connected. The A7 is being powered by internal batteries.
	Battery supply is partially charged. AC power is not connected. The A7 is being powered by internal batteries.
	Battery supply has a low charged. Batteries need to be charged immediately to operate as a safe power backup. AC power is not connected. The A7 is being powered by internal batteries.
	Battery supply is not installed.

**FIGURE 3-13** Battery Status

## 3.3 Fresh Gas Flow Display

### 3.3.1 Electronic Flow Control System

The A7 System flowmeter displays real-time flowmeter levels for O<sub>2</sub> and balance gas (see FIGURE 3-14). Balance gas can be set to either AIR or N<sub>2</sub>O.

The flowmeter numerics display a precision to two decimal digits for flows < 1 L/min and one decimal digit for flows ≥ 1 L/min.

The A7 System flowmeter is electronically controlled by the Electronic Flow Control System (hereinafter referred to as EFCS).

EFCS has two control modes: Total Flow and Direct Flow. To set the control mode,

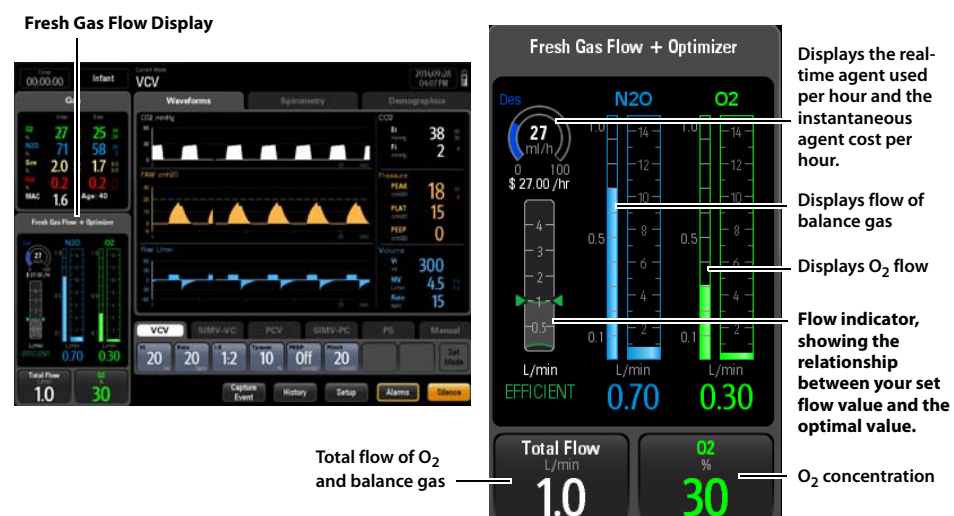
1. Select **Setup** softkey > **General** tab on the main screen.
2. Set the **Fresh Gas Control** to **Total Flow** or **Direct Flow**.
3. Select the **Accept** button to confirm the change, or select the **Cancel** button to discard the change.

Or (software bundle version 02.09.00 and later)

1. Select the button in the **Fresh Gas Flow** area to open the **Total Flow Control** menu or the **Direct Flow Control** menu.
2. Set the **Fresh Gas Control** to **Total Flow** or **Direct Flow**.
3. Select the **Accept** button to confirm the change, or select the **Cancel** button to discard the change.

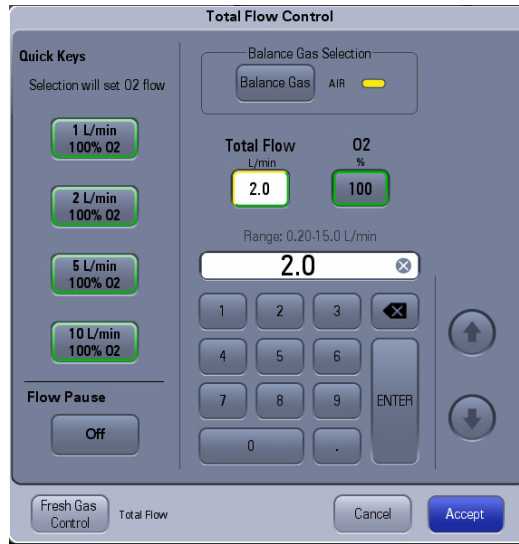
#### 3.3.1.1 Total Flow Control Mode

FIGURE 3-14 shows the electronic flow control system in total flow control mode.



**FIGURE 3-14** Electronic Flow Control System in Total Flow Control Mode

Select O<sub>2</sub> concentration or Total Flow to open Total Flow Control menu (see FIGURE 3-15).



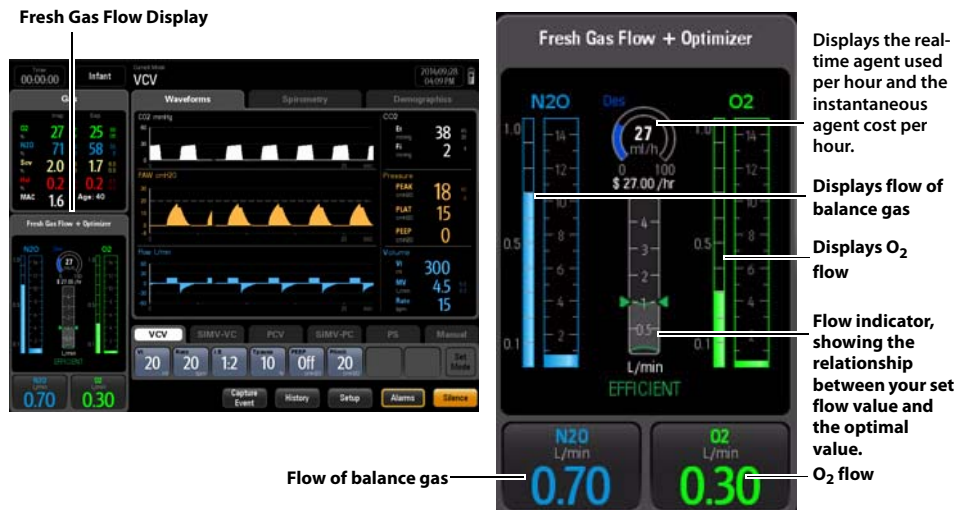
**FIGURE 3-15** Total Flow Control Menu

You can make the following settings in Total Flow Control menu:

- Set O<sub>2</sub> flow of 100% O<sub>2</sub> using the Quick Keys.
- Set **Balance Gas** to **AIR**, **N<sub>2</sub>O** or **None**.
- Set the flow value of Total Flow via soft keyboard.
- Set the O<sub>2</sub> concentration value via soft keyboard.
- Set the **Fresh Gas Control** to **Direct Flow** (software bundle version 02.09.00 and later).
- Set the **Flow Pause** to **On** (software bundle version 02.09.00 and later).

### 3.3.1.2 Direct Flow Control Mode

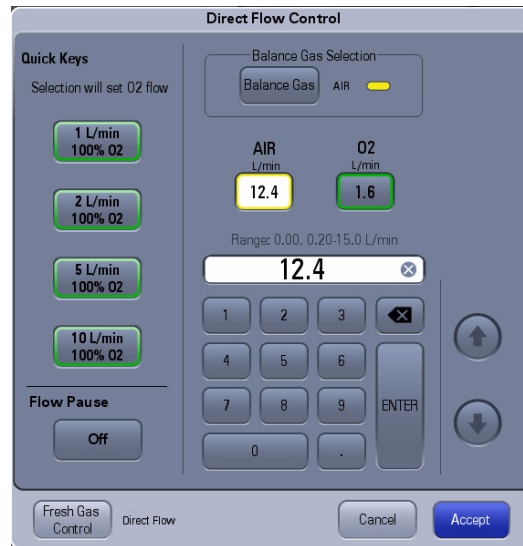
FIGURE 3-16 shows the electronic flow control system in direct flow control mode.



**FIGURE 3-16** Electronic Flow Control System in Direct Flow Control Mode



Select an O<sub>2</sub> flow button or the balance gas flow button to open Direct Flow Control menu (see FIGURE 3-17).



**FIGURE 3-17** Direct Flow Control Menu

You can make the following settings in Direct Flow Control menu:

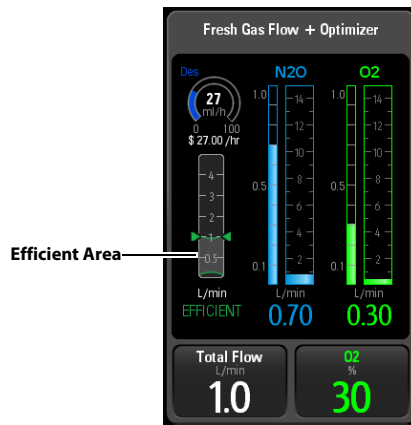
- Set O<sub>2</sub> flow of 100% O<sub>2</sub> using the Quick Keys.
- Set **Balance Gas** to **AIR**, **N<sub>2</sub>O** or **None**.
- Set the flow value of balance gas via soft keyboard.
- Set the O<sub>2</sub> flow value via soft keyboard.
- Set the **Fresh Gas Control** to **Total Flow** (software bundle version 02.09.00 and later).
- Set the **Flow Pause** to **On** (software bundle version 02.09.00 and later).

### 3.3.1.3 Fresh Gas Flow Optimizer® (software bundle version 02.09.00 and later)

The **OPTIMIZER**® indicates an efficient range of fresh gas delivered to the patient, and the efficient area is defined as a range with a lower bound of "Fresh Gas Consumption" and an upper bound of "Fresh Gas Consumption + 1 L/min".

Fresh gas consumption of the subject A7 depends on:

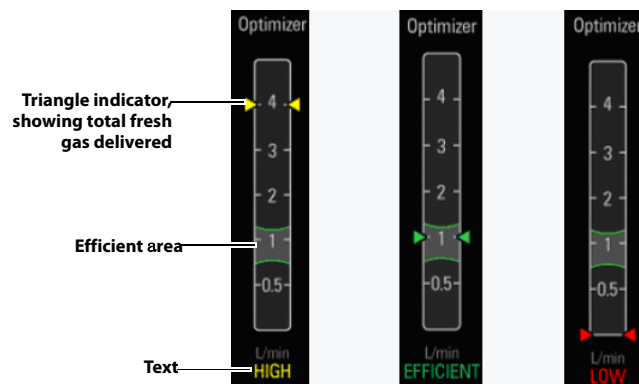
- the uptake by the patient,
- leakage,
- the CO<sub>2</sub> volume converted in the absorber.



**FIGURE 3-18** OPTIMIZER®

The triangle indicator on the **OPTIMIZER®** display shows the real-time total fresh gas flow delivery. The "efficient" range (1 L/min wide) is also shown (FIGURE 3-18).

If the indicator is above the efficient area, the **OPTIMIZER®** will indicate a **HIGH** with text and indicator in yellow. If the indicator is located at the efficient area, the **OPTIMIZER®** will indicate an **EFFICIENT** with text and indicator in green. If the indicator is under the efficient area, the **OPTIMIZER®** will indicate a **LOW** with text and indicator in red.

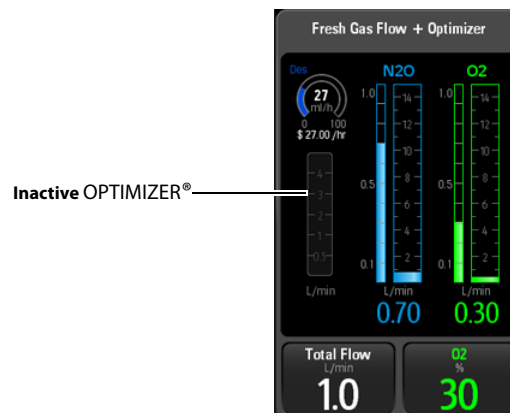


**FIGURE 3-19** OPTIMIZER® Indication States

INDICATION	INDICATION COLOR	MEANING
HIGH	Yellow	Total fresh gas delivery is more than 1 L/min above the gas consumption (leak+uptake).
EFFICIENT	Green	Total fresh gas delivery is efficient.
		<b>NOTE: EFFICIENT does not imply clinical efficiency.</b>
LOW	Red	Total fresh gas delivery is less than the gas consumption (leak+uptake).

**TABLE 3-1** Indication

- NOTE:** OPTIMIZER® is active only when all the following conditions are met.
- EFCS is active.
  - External AG module is active.
  - The anesthesia system is in mechanical ventilation mode.
- NOTE:** OPTIMIZER® is disabled if automatic circuit leak test is skipped or failed.
- NOTE:** OPTIMIZER® is disabled if the measurement value of Vt, MV, EtCO2, FICO2, or Rate is invalid.
- NOTE:** If fresh gas data is unavailable, the OPTIMIZER® will be ineffective.
- NOTE:** OPTIMIZER® is disabled if any of the following alarms appears:
- Apnea
  - Apnea > 2 min
  - Apnea CO2
  - Flow Sensor Failure
  - Check Flow Sensors
  - PInsp Not Achieved
  - Vt Not Achieved
  - Patient Circuit Leak
  - CO2 Absorber Canister not Locked
  - Ventilator Comm Stop
  - Drive Gas Pressure Low
  - AG Hardware Error
  - External AG Self Test Error
  - AG Hardware Malfunction
  - AG Init Error
  - AG No Watertrap
  - AG Change Watertrap
  - AG Comm Stop
  - AG Airway Occluded
  - AG Zero Failed
  - External AG Module Disconnected
  - Incompatible AG Software Version



**FIGURE 3-20** Inactive OPTIMIZER®

- NOTE:** If fresh gas data is unavailable, the OPTIMIZER® will be ineffective.

**NOTE:** It is recommended to connect the AG outlet to the sample gas return port when the OPTIMIZER® is in use.

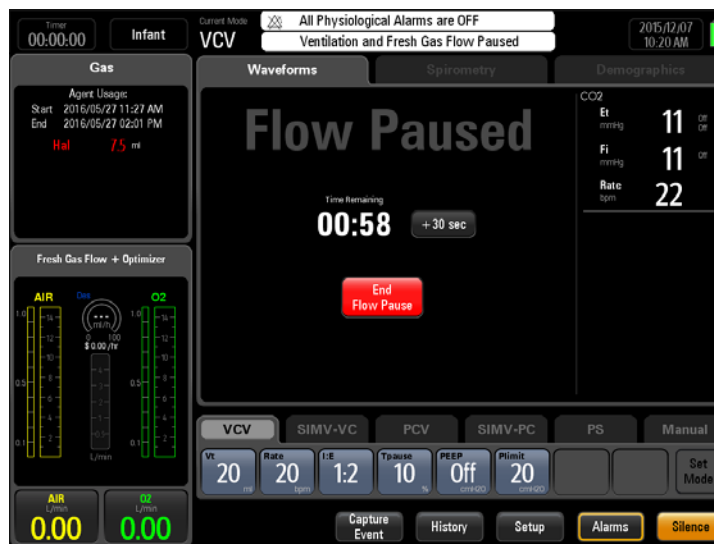
### 3.3.2 Flow Pause (software bundle version 02.09.00 and later)

Use **Flow Pause** to temporarily suspend the flow of gas during a case. Using **Flow Pause** while the breathing system is disconnected prevents the flow of gas into the room. **Flow Pause** is available during both mechanical ventilation and manual ventilation.

To enter **Flow Pause** state:

1. Select the button in the **Fresh Gas Flow** area to open the **Total Flow Control** menu or the **Direct Flow Control** menu.
2. Set the **Flow Pause** to **On**.
3. Select the **Accept** button to confirm the change. The system will enter the **Flow Pause** state.

The **Flow Pause** screen is displayed in the FIGURE 3-21.



**FIGURE 3-21** Flow Pause

When the system is in the **Flow Pause** state:

- The fresh gas flow is turned off.
- The mechanical ventilation is suspended.
- All physiological alarms are disabled.
- The countdown timer is enabled. The default countdown time is 60 seconds. You can select **+30 sec** button to add 30 seconds to the current countdown time. The maximum countdown time is 2 minutes.

To exit the **Flow Pause** state:

- The system exits the **Flow Pause** state automatically when the countdown time is 00:00.
- Select **End Flow Pause** button to exit the **Flow Pause** state.
- The system exits the **Flow Pause** state automatically when the system enters **Standby** mode or the BFCS is enabled.

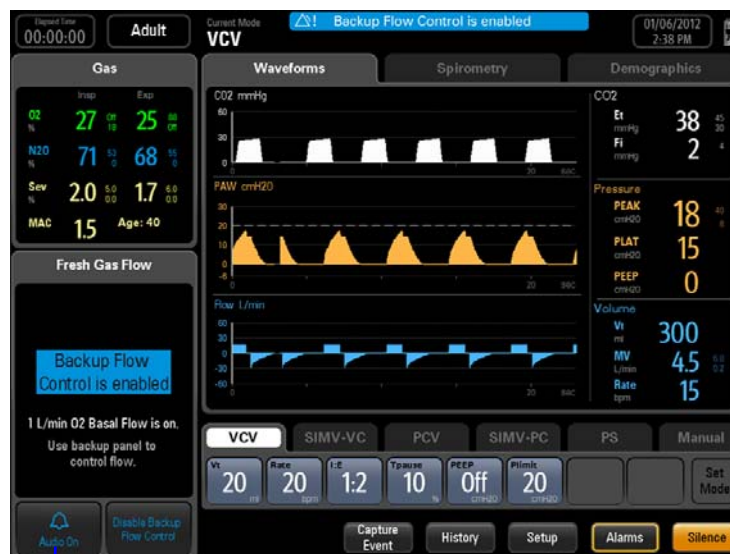
After the system exits the **Flow Pause** state:

- The fresh gas flow resumes at the settings from before entering the **Flow Pause** state.
- Ventilation resumes in the same ventilation mode and with the same parameter settings as before entering the **Flow Pause** state.
- All physiological alarms are enabled.

### 3.3.3 Backup Flow Control System


When the A7 System detects a failure related to the EFCS, then the backup flow control system (hereinafter referred to as BFCS) automatically deploys and the total flow rotameter illuminates. If the BFCS is deployed due to a failure, contact a service personnel to disable the BFCS.

FIGURE 3-22 shows BFCS display screen.



Audio On/Off button

**FIGURE 3-22** Backup Flow Control System

There is 1 L/min of O<sub>2</sub> flow automatically when the BFCS is deployed and turning the flow control knobs will only increase the flow from 1 L/min. When BFCS is in use, you can adjust flow via flow control knobs. The total flow rotameter indicates the total flow. Approximate the O<sub>2</sub> flow and air flow based on the O<sub>2</sub> concentration displayed on the screen. You can turn on or off the audio of Alarm **Backup Flow Control is enabled** by selecting the **Audio On** or **Audio Off** toggle button. When the alarm is audio off, the  icon displays in the right of the alarm display area. This Audio off button can only turn off the Backup Flow Control technical alarm and the Electronic Flow Control Fail alarm.

When EFCS is active, you can deploy BFCS by pushing the BFCS button. To disable BFCS, close the flow knobs first and then select the **Disable Backup Flow Control** button on the main screen. Next, you select **Yes** from the pop-up dialog box to disable BFCS.

When the alarm **Low Battery Voltage!** occurs, the system automatically deploys the BFCS inactivating the **Disable Backup Flow Control** button. Connect to the AC power supply as soon as possible. After connecting to the AC power supply, the **Disable Backup Flow Control** button is enabled. Press this button and select **Yes** from the pop-up dialog box to disable the BFCS.

## 3.4 Waveforms Tab

Displays PAW, Flow, Volume, CO<sub>2</sub>, O<sub>2</sub>, N<sub>2</sub>O and AA (AA stands for anesthetic agent) waveforms (see FIGURE 3-23).



**FIGURE 3-23** Main Screen Waveforms Tab

### 3.4.1 Waveforms Autoscaling

If the measured value of Paw, Flow, or Volume is larger than the boundary at the end of breath cycle, the system auto scales the waveform at the beginning of the next breath cycle.

If the measured value of Paw, Flow, or Volume is less than the boundary minus a margin at the end of two continuous breath cycles, the A7 System auto scales the waveform at the beginning of the next breath cycle.

#### Paw scale:

- The margin is 3 cmH<sub>2</sub>O if Paw < 30 cmH<sub>2</sub>O
- The margin is 10 cmH<sub>2</sub>O if Paw ≥ 30 cmH<sub>2</sub>O

#### Flow scale:

- The margin is 10 L/min if Flow ≤ 30 L/min
- The margin is 15 L/min if Flow > 30 L/min

**Volume scale:**

- The margin is 25 ml if Volume  $\leq$  100 ml
- The margin is 100 ml if Volume  $>$  100 ml

### 3.4.2 Waveforms Manual Scaling

The scale of CO<sub>2</sub>, O<sub>2</sub>, N<sub>2</sub>O, and AA (AA stands for anesthetic agent) waveforms can be set manually through the menu:


1. Select **Setup** softkey  $>$  **Display** tab.
2. Select the **Gas Scales** button.

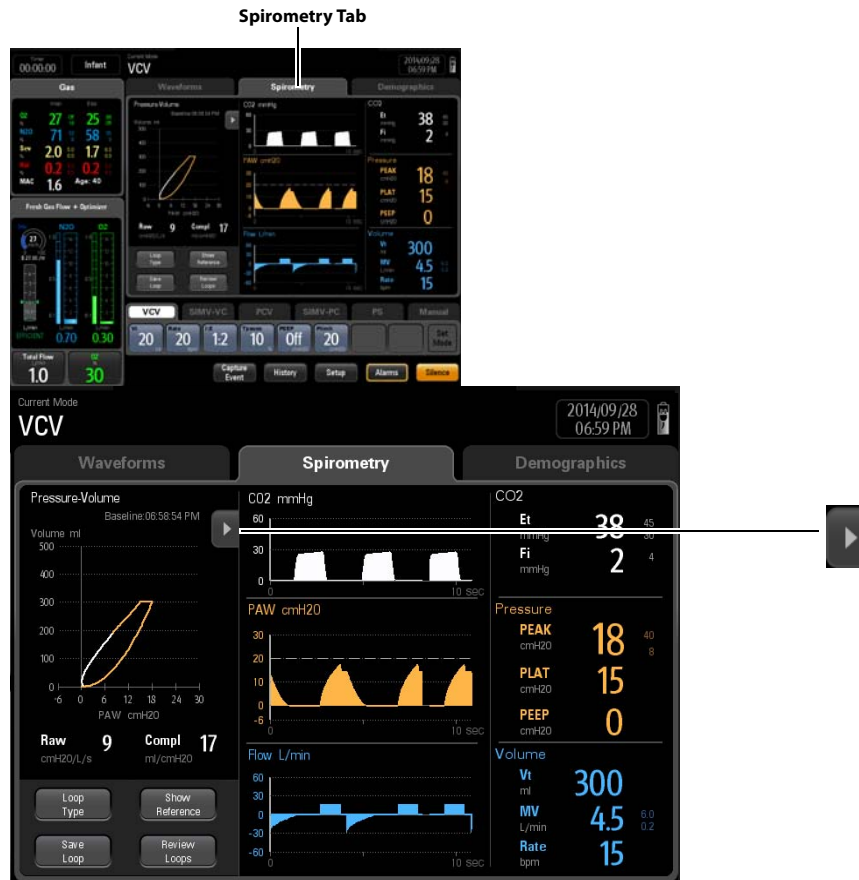
GAS SCALES	UNIT OF MEASURE	SCALE		
	mmHg	0-40	0-60	0-80
CO <sub>2</sub> Scale	kPa	0.0-5.0	0.0-8.0	0.0-10.0
	%	0.0-5.0	0.0-8.0	0.0-10.0
O <sub>2</sub> Scale	%	0-35	0-50	0-100
N <sub>2</sub> O Scale	%	0-35	0-50	0-100
Des Scale	%	0.0-6.0	0.0-9.0	0.0-18.0
Sev Scale	%	0.0-2.0	0.0-4.0	0.0-8.0
Iso Scale	%	0.0-1.2	0.0-2.5	0.0-5.0
Hal Scale	%	0.0-1.2	0.0-2.5	0.0-5.0
Enf Scale	%	0.0-1.2	0.0-2.5	0.0-5.0

**TABLE 3-2** Gas Scales

### 3.5 Spirometry Tab


Displays separate looped graphs and waveforms (See FIGURE 3-24).

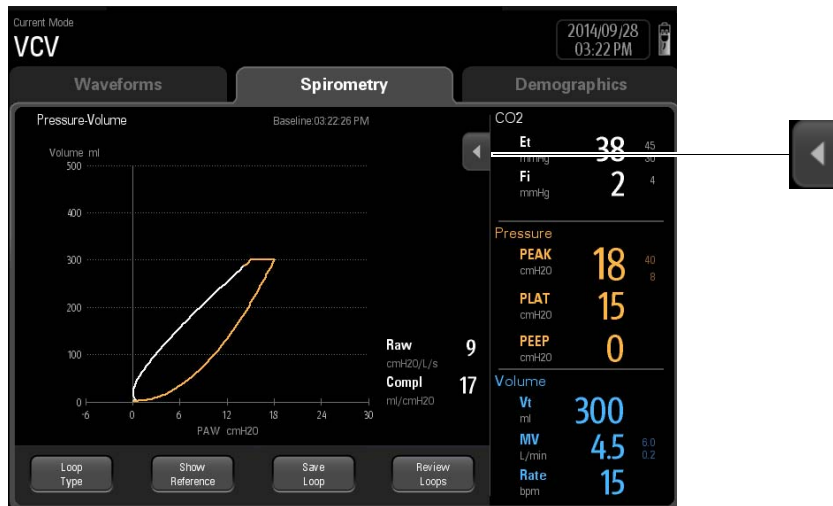
You can press the  button (see FIGURE 3-24) to only view the spirometry loop (see FIGURE 3-25).



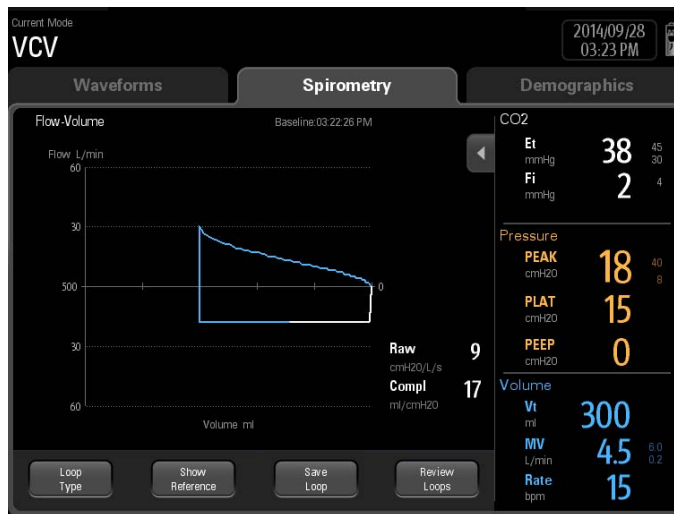
**FIGURE 3-24** Spirometry and Waveforms



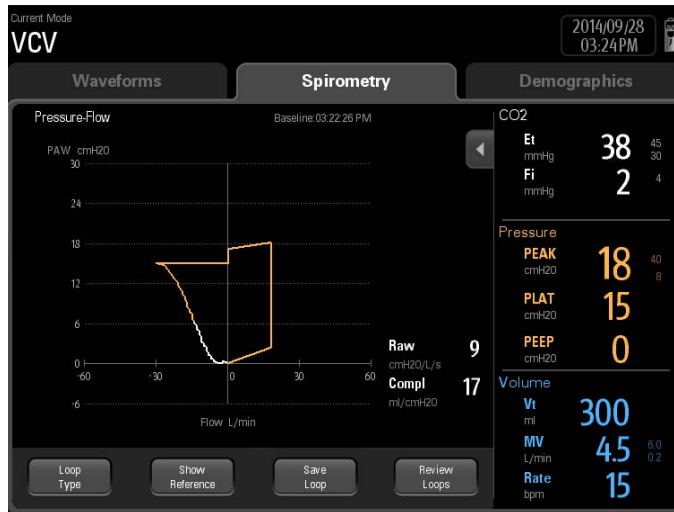
You can press the  button (see FIGURE 3-25) to see the spirometry loop and waveforms (see FIGURE 3-24).



**FIGURE 3-25** Spirometry: Pressure-Volume Loop



**FIGURE 3-26** Spirometry: Flow-Volume Loop



**FIGURE 3-27** Spirometry: Pressure-Flow Loop

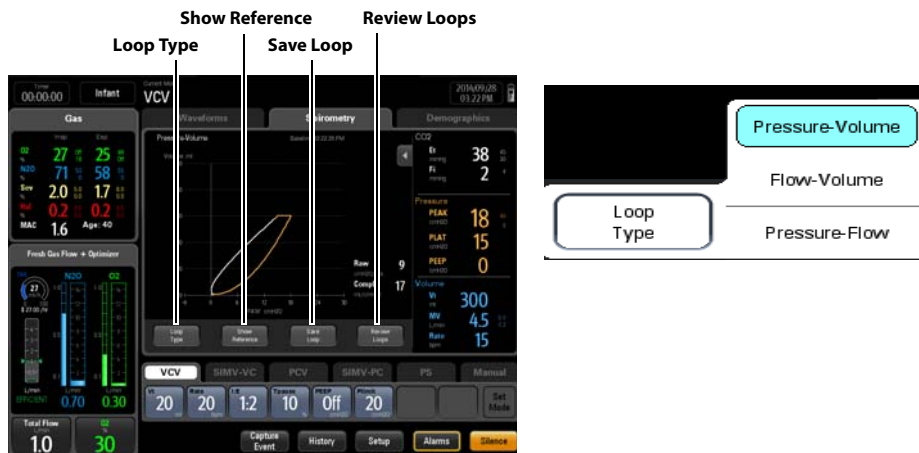
Spirometry loops reflect patient lung function and ventilation. They also indicate other related parameters such as compliance, over-inflation, breathing system leak, and airway blockage.

The system provides three types of spirometry loops: pressure - volume loop (see FIGURE 3-25), flow - volume loop (see FIGURE 3-26) and pressure - flow loop (see FIGURE 3-27). Loops data comes from pressure and flow data. Only one loop displays at a time.

The **Spirometry** tab displays four softkeys: **Loop Type**, **Show Reference**, **Save Loop**, and **Review Loops**.

### 3.5.1 Loop Type

Select **Loop Type** to display pressure - volume loop, flow - volume loop or pressure-flow loop on the Spirometry screen. Default loop type is pressure - volume loop.



**FIGURE 3-28** Spirometry Softkeys: Loop Type, Show Reference, Save Loop, and Review Loops

## 3.5.2 Show Reference

Select **Show Reference** softkey only after saving a baseline via the **Save Loop** softkey.

Select **Show Reference** softkey (see FIGURE 3-28) to display a saved baseline loop, reference loop, or no loop (Off) in the spirometry loop window, overlapped with the currently plotting loop. Only the four most recently saved reference loops are listed chronologically.

When a reference loop or baseline loop is selected to display in the spirometry loop window, the time stamp will also display.

## 3.5.3 Save Loop

Select the **Save Loop** softkey (see FIGURE 3-28) to save the currently plotting loop (including its numeric data) as either a baseline loop or reference loop. Only one baseline loop and up to four reference loops can be saved. Save additional plotting loops to replace the baseline loop or reference loops. Only the four most recent reference loops are saved.

Review the saved baseline or reference loop with its numeric data (via **Review Loops** softkey) or displayed with the currently plotting loop on the same graph for comparison (via **Show Reference** softkey).

**NOTE:**        **A reference loop can-not be saved without first saving a baseline loop. The A7 System always makes the first saved loop as the baseline loop if no previous loops have been saved. Afterward, additional loops can be saved either as a baseline replacement or as a new reference loop.**

**To save a baseline loop :**

1. From the main screen, select **Spirometry** tab > **Save Loop** softkey.  
If there is no baseline loop saved in memory, the currently plotting loop will be saved automatically as the baseline loop.
2. If a baseline loop is already saved in memory, a dialog box displays with the choices of **Baseline** and **Reference**. Select **Baseline**. A confirmation dialog will be displayed with the text **Selecting Yes will replace the currently saved Baseline loop. Do you want to proceed?** If **Yes** is selected, the currently saved baseline loop will be replaced. If **No** is selected, the save will be canceled.

**To save a reference loop:**

1. From the main screen, select **Spirometry** tab > **Save Loop** softkey. If a baseline loop is already saved in memory, a dialog box displays with the choices of **Baseline** and **Reference**. Select **Reference**.

A maximum of four (4) sets of reference loops plus one (1) Baseline loop and corresponding numeric data can be saved.

When the maximum of four (4) loops is reached, and the user attempts another save, a confirmation dialog will be displayed with the following text, **Selecting Yes will replace the oldest reference loop. Do you want to proceed?** If **Yes** is selected, the oldest data will be removed as the new data is added. If **No** is selected, the save will be canceled.

### 3.5.4 Review Loops Button

Selecting the **Review Loops** softkey (see FIGURE 3-28) displays the **Review Loops** screen (see FIGURE 3-29). The following areas and selections display:

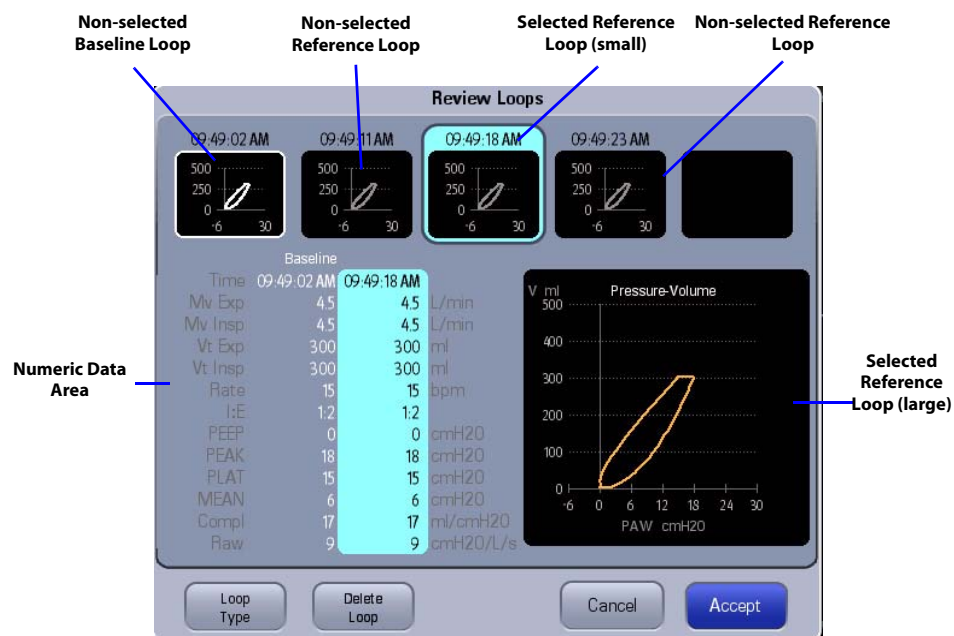
**Small Loop Window:** These small graphic windows show the baseline and reference loops. The baseline loop (only one) is always located on the left and has a white border around its graph. The reference loops (up to four) are located to the right of the baseline loop. The reference loops are displayed from oldest (left) to newest (right).

The baseline loop information is displayed below the small baseline loop window. The reference loop information is displayed in **cyan** highlight for the reference loop that is selected.

**Large Loop Window:** This graphic window shows an enlarged view of the selected reference loop overlapped with the baseline loop.

**Loop Type:** Use the **Loop Type** softkey to choose the type of loop to review. The choices are: **Pressure - Volume**, **Flow - Volume** and **Pressure - Flow**. Default loop type is **Pressure - Volume** loop.

**Delete Loop:** Use the **Delete Loop** softkey to delete a selected reference loop. When a reference loop is deleted, the newer reference loops will shift to the left. The **Delete Loop** softkey will be disabled (grayed out) if no reference loops have been saved. The baseline loop cannot be deleted. It can only be replaced by another baseline loop.



**FIGURE 3-29** Review Loops window

**Numeric Data Area:** Displays the numerical data associated with a saved baseline loop and saved reference loops.

The parameters listed in column form include:

- Time
- Expiratory Minute Volume (Mv Exp)
- Inspiratory Minute Volume (Mv Insp)
- Expiratory Tidal Volume (Vt Exp)
- Inspiratory Tidal Volume (Vt Insp)
- Ratio of Inspiratory time to Expiratory time (I:E)
- Positive End Expiratory Pressure (PEEP)
- Rate
- Peak Inspiratory Pressure (PEAK)
- Plateau Pressure (PLAT)
- Mean Pressure (MEAN)
- Dynamic Airway Compliance (Compl)
- Airway Resistance (Raw)

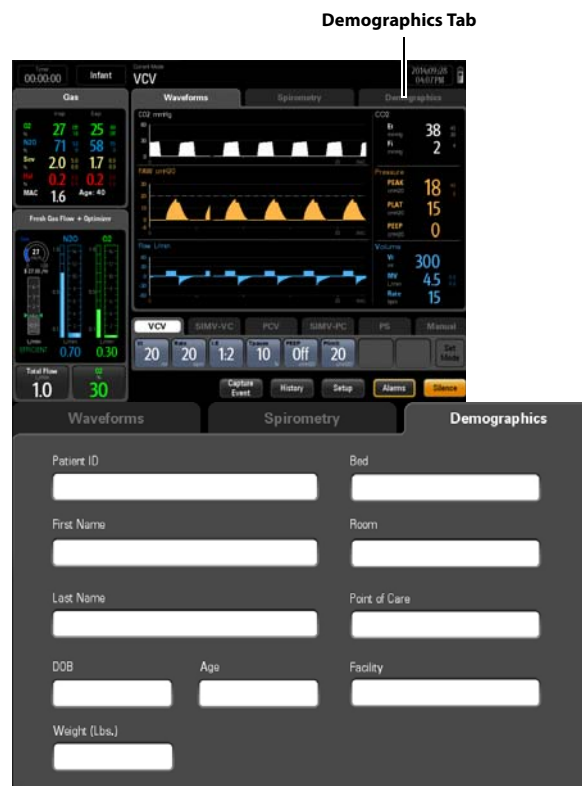
## 3.6 Demographics Tab

The **Demographics** tab contains editable fields to enter patient and hospital data (see TABLE 3-3).

**NOTE:** Enter facility data when first setting up the system. After entering facility data, go to the System tab > Manage Defaults > Save as O.R. Defaults so that the data is not erased in case of power cycle or end of case.

EDITABLE FIELD	COMMENT
<b>Patient ID</b>	Enter up to 30 characters per field. These fields are cleared when the case has ended or if the A7 is power cycled.
<b>First Name</b>	
<b>Last Name</b>	
<b>DOB (Date Of Birth)</b>	Enter the information from the virtual keypad. If the input is outside the accepted range, a prompt message is displayed. If the age of the patient is less than 1, the <b>Age</b> will display < 1. These fields are cleared when the case has ended or if the A7 is power cycled.
<b>Age</b>	
<b>Weight (lbs/kg)</b>	
<b>Bed</b>	Enter up to 20 characters per field. When the Restore default settings checkbox is selected, these fields are NOT cleared when the case has ended.
<b>Room</b>	
<b>Point of Care</b>	
<b>Facility</b>	

**TABLE 3-3** Demographic Tab Fields for Patient and Hospital Data



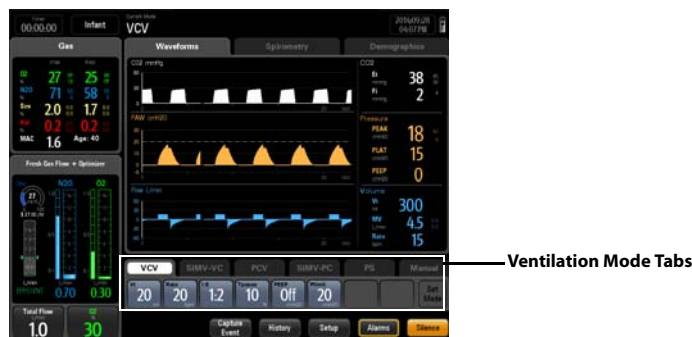
**FIGURE 3-30** Demographics Tab

## 3.7 Ventilation Mode Tabs

Displays tabs for all ventilation modes. Each tab displays the ventilation mode and its parameters. (FIGURE 3-31 to FIGURE 3-37)

A7 ventilation modes:

- Volume Control Ventilation (VCV)
- Synchronized Intermittent Mandatory Ventilation with VC mode (SIMV-VC)
- Pressure Control Ventilation (PCV)
- Synchronized Intermittent Mandatory Ventilation with PC mode (SIMV-PC)
- Pressure Support ventilation (PS)
- Manual
- Bypass
- Monitor (with AG module)



**FIGURE 3-31** Ventilation Mode Tabs

To change the ventilation mode:

1. Select a desired ventilation mode tab. The **Set Mode** softkey begins to blink green.
2. Optionally, select one or more parameter buttons to change the parameter settings of the desired ventilation mode. Select the **Accept** button to save each parameter change.
3. Select the **Set Mode** softkey to finalize and change the ventilation mode.

**NOTE:** If the **Set Mode** softkey is not selected after several seconds, an audible reminder is sounded, and then the desired ventilation mode is cancelled.



**FIGURE 3-32** Ventilation Mode: VCV



**FIGURE 3-33** Ventilation Mode: SIMV-VC



**FIGURE 3-34** Ventilation Mode: PCV



**FIGURE 3-35** Ventilation Mode: SIMV-PC



**FIGURE 3-36** Ventilation Mode: PS



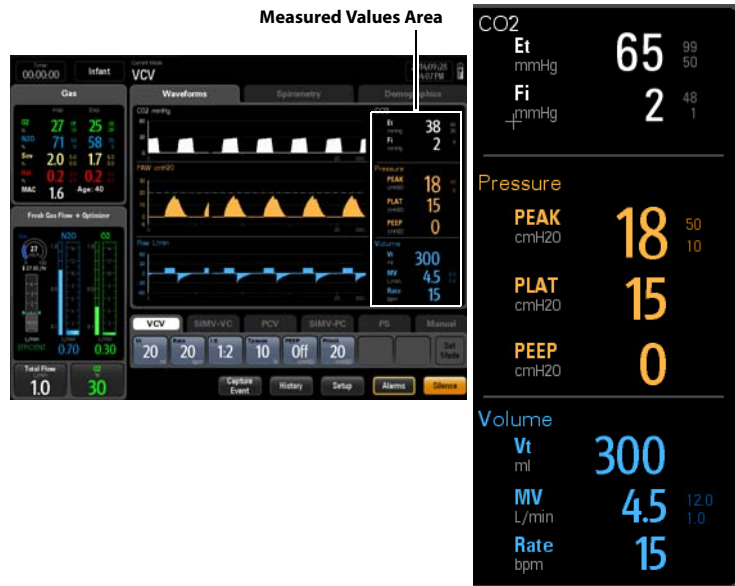
**FIGURE 3-37** Ventilation Mode: Manual

**NOTE:** Monitor mode available when external AG module connected.



## 3.8 Measured Values Area

The Measured Values area is used to display the numerical data. (FIGURE 3-38)



**FIGURE 3-38** Measured Values Area

## 3.9 System Softkeys

The A7 System provides system softkeys at the bottom right of the main screen for direct access to the history menu, system setup and alarms menu, and for capturing events and silencing alarms (see FIGURE 3-39).



**FIGURE 3-39** System Softkeys

### 3.9.1 Setup Softkey

Select the **Setup** softkey (FIGURE 3-39) to open the **Setup** menu .

The **Setup** menu contains the **General** tab, **Display** tab, **System** tab, and **Service** tab. See section 3.10 (page 3-36) "General Tab".

**NOTE:**        **The System tab is only available in the Standby mode.**

**NOTE:**        **The Service tab is for use only by Mindray Technical Service. Please contact Mindray Technical Support for details.**

Many of these functions are only available if the A7 is in **Standby** mode.

### 3.9.2 Alarms Softkey

Select the **Alarms** softkey on the main screen to open the **Alarms** menu to set alarm limits, set alarm volume, and view all active alarms. See "Alarms and Messages" on page 6-1.

### 3.9.3 Silence Softkey

Select the **Silence** softkey on the main screen to silence all currently sounding alarm tones for 120 seconds. The alarm silence icon and 120 second countdown time appear at the top of the screen. Select again to clear the alarm silence. Note, however, the alarm will sound if a new alarm occurs while the system is in a silenced state. If this occurs, you can select the Silence softkey again to silence the new alarm and reset the silence countdown timer to 120 seconds.

### 3.9.4 Capture Event Softkey

Select the **Capture Event** softkey on the main screen to capture parameters and log it in the **Event Log** (see FIGURE 3-42). The **Capture Event** softkey is disabled when the machine is in **Standby**.

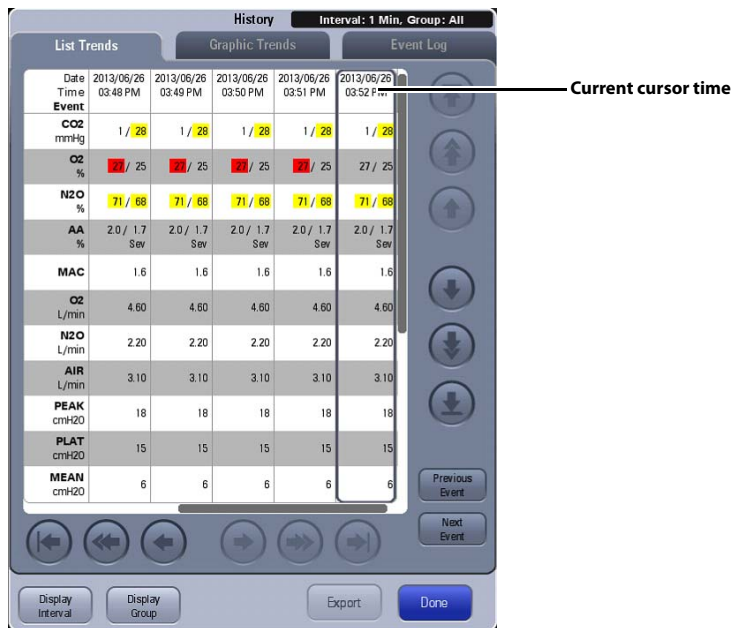
### 3.9.5 History Softkey

Select the **History** button on the main screen to access a patient's historical physiological parameters. The History dialog contains **List Trends**, **Graphic Trends** and an **Event Log** tab. There is an interactive link among the three history tabs. When switching between tabs, the cursor will automatically position itself on the corresponding record that was selected in the previous tab.

#### 3.9.5.1 List Trends

Select the **History** button on the main screen to access the **List Trends**. The **History** dialog displays (see FIGURE 3-40) with the **List Trends** tab selected.

The List Trends displays a tabular list of the physiological parameters. Trend data automatically displays in one minute intervals unless an alternate interval is selected.



**FIGURE 3-40** List Trends



### 3.9.5.1.1 About List Trends

- List Trends displays the time and date on the horizontal axis and it is always visible.
- List Trends displays the parameter name on the vertical axis and it is always visible.
- List Trends displays the trend records in descending order beginning with the most recent on the right side of the grid.
- List Trends are not stored when the machine is in the standby mode.
- The display period of data is a rolling 48 hours of continuous data.
- List Trends highlights the parameter data in the corresponding alarm color if an alarm condition existed for the parameter at the time of trend record storage.

### 3.9.5.1.2 Navigating in List Trends

The dialog navigation buttons are described in TABLE 3-4.

**NOTE:** Disabled navigation buttons indicate that there is no more data available or the end of the data range was reached.

BUTTON	FUNCTION
	Moves the cursor one record back from its current position.
	Moves the cursor one record forward from its current position.

BUTTON	FUNCTION
	Moves the cursor up one parameter from its current position.
	Moves the cursor down one parameter from its current position.
	Moves the cursor one page back from its current position.
	Moves the cursor one page forward from its current position.
	Moves the cursor up one page from its current position.
	Moves the cursor down one page from its current position.
	Moves the cursor to the oldest record from its current position.
	Moves the cursor to the newest record from its current position.
	Moves the scroll to the top most parameter from its current position.
	Moves the scroll to the bottom most parameter from its current position.
Previous Event	Moves the cursor to the previous event from its current position.
Next Event	Moves the cursor to the next event from its current position.

**TABLE 3-4**

### 3.9.5.1.3 Display Interval

Display Interval displays the trends in a specified time interval between two neighboring columns.

Set **Display Interval** to **1 Min, 5 Min, 10 Min, 15 Min, 30 Min, 1 Hour, or 2 Hour**.

### 3.9.5.1.4 Display Groups

Display Group displays the trends in a specified parameter group.

Set **Display Group** to **Gas, Fresh Gas, Ventilation, or All**.

### 3.9.5.1.5 List Trend Export

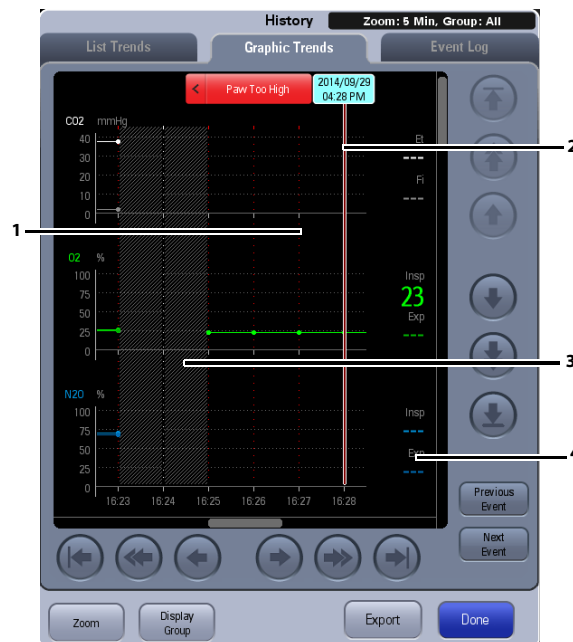
The **Export** button on the **List Trend** tab will allow the contents of the history to be exported to a USB mass storage device. The format of the data exported is a .html file which can be opened using Internet Explorer version 6.0, 7.0 and 8.0. The **Export** button on the **List Trend** tab is only available when the system is in **Standby** mode.

**NOTE: If Internet Explorer greater than version 8.0 is used to view the exported file, set it to compatibility mode.**

## 3.9.5.2 Graphic Trends

Select the **History** button on the main screen and then select the **Graphic Trends** tab to access the **Graphic Trends**. The History dialog displays (see FIGURE 3-41) with the Graphic Trends tab selected.

Graphic trends display allows the user to observe the trend of the physiological parameters. The trend is reflected through a curve. Every point on the curve corresponds to the parameter value at a specific time point. **Graphic Trends** tab displays end case event, captured event and parameter alarm event. Graphic trend data automatically displays in one minute intervals unless the zoom is selected.



**FIGURE 3-41** Graphic Trends

NUMBER	DESCRIPTION
1	Event marker. The dotted, colored line indicates an event occurred at that time. Events could be any of the following: end case, capture an event or a physiological alarm occurrence. For end case or capture an event, the dotted line is white. For physiological alarm occurrence, the dotted line is in the same color as alarm. If multiple events occurred, dotted line is in same color as the event of the highest alarm level. The event level can be specified as: high alarm level event > medium alarm level event > low alarm level event > capture event > end case event.
2	Current cursor. The corresponding time displays above the cursor. If alarms or events occurred at that time, the corresponding alarm information or events will also display above the cursor (hereinafter referred to as event bubble). Clicking on the event bubble will cause the event log tab (see FIGURE 3-42) to open on that specific event.
3	An end case event occurred during this period.
4	The parameter data of the time indicated by cursor.

**TABLE 3-5**

**NOTE:** The Graphic Trends will be cleared after the anesthesia machine undergoes power failure or is turned off.









### 3.9.5.2.1 About Graphic Trends

- Graphic Trends store the data with the interval in 1 minute.
- Graphic Trends displays the trend records in descending order beginning with the most recent on the right side of the grid.
- Graphic Trends are not stored when the machine is in standby.
- The display period of data is a rolling 48 hours of continuous data.
- Graphic Trends highlights the parameter data in the corresponding alarm color if an alarm condition existed for the parameter at the time of trend record storage.

### 3.9.5.2.2 Navigating in Graphic Trends

The dialog navigation buttons are described in TABLE 3-6.

**NOTE:** When a navigation button becomes disabled, this indicates that there is no more data available or the end of the data range was reached.

BUTTON	FUNCTION
	Moves the cursor to the oldest record from its current position.
	Moves the cursor one page back from its current position.
	Moves the cursor one record back from its current position.
	Moves the cursor one record forward from its current position.
	Moves the cursor one page forward from its current position.
	Moves the cursor to the newest record from its current position.
Previous Event	Moves the cursor to the previous event from its current position.
Next Event	Moves the cursor to the next event from its current position.
	Moves the cursor up one parameter from its current position.
	Moves the cursor down one parameter from its current position.

**TABLE 3-6**

### 3.9.5.2.3 Zoom

Zoom allows the trends to be displayed in one page in a specified time interval.

Set **Zoom** to **5Min**, **10Min**, **15Min**, **30Min**, **1Hour**, or **2Hour**.

### 3.9.5.2.4 Display Groups

Display Group allows for the trends to be displayed in a specified parameter group.

Set **Display Group** to **Gas, Fresh Gas, Ventilation, or All**.

### 3.9.5.2.5 Graphic Trends Export

The **Export** button on the **Graphic Trends** tab will allow the contents of the history to be exported to a USB mass storage device. The format of the data exported is a .html file which can be opened using Internet Explorer version 6.0, 7.0 and 8.0. The **Export** button on the **Graphic Trends** tab is only available when the system is in **Standby** mode.

**NOTE:** If Internet Explorer greater than version 8.0 is used to view the exported file, set it to compatibility mode.

### 3.9.5.3 Event Log

Select the **History** button on the main screen and then select the **Event Log** tab to access the **Event Log**. The History dialog displays (see FIGURE 3-42) with the **Event Log** tab selected.



**FIGURE 3-42** Event Log

The **Event Log** tab logs such events as technical alarms, physiological alarms, capture events, delay power off, end case, delay power off canceled and system time change. Events can be physiological indicating that a patient's physiological alarm thresholds have been violated or technical indicating that a specific technical issue has occurred.

An alarm entry and captured events in the Event Log displays the time, date, event, priority and additional information which includes the ventilation mode, patient size, and monitored parameters.







**NOTE:** The Event log will be cleared after the anesthesia machine undergoes a power failure or is turned off. To view event log, contact Mindray Customer Service.

#### 3.9.5.3.1 Navigating in Event Log

The dialog navigation buttons are described in TABLE 3-7.



**NOTE:** Disabled navigation buttons indicate that there is no more data available or the end of the data range was reached.

BUTTON	FUNCTION
	Moves the cursor up one record from its current position.
	Moves the cursor down one record from its current position.
	Moves the cursor up one page from its current position.
	Moves the cursor down one page from its current position.
	Moves the scroll to the top most record from its current position.
	Moves the scroll to the bottom most record from its current position.

**TABLE 3-7**

### 3.9.5.3.2 Event Log Filter

The **Filter** button displays the Event Log Entries trends similarly to the Event type.

Set **Filter** to **High, Medium, Low, Informational** or **All**. The A7 displays the corresponding event based on your setting.

### 3.9.5.3.3 Event Log Export

The **Export** button on the **Event Log** tab exports the contents of the event log to a USB mass storage device. The format of the data exported is an .html file which can be opened using Internet Explorer version 6.0, 7.0 and 8.0. The **Export** button on the **Event Log** tab is only available when the system is in **Standby** mode.

**NOTE:** If Internet Explorer greater than version 8.0 is used to view the exported file, set it to compatibility mode.

## 3.10 General Tab

The **General** tab provides access to flow sensor calibration, system leak performance and compliance tests, breathing system warmer activation, and zero flow meters. The **General** tab also displays information for the most recent calibrations and leak test results, whether they were passed, failed, or skipped. (See FIGURE 3-43)



**FIGURE 3-43** General Tab

### Calibrate Flow Sensor

To calibrate the flow sensor, select the **Calibrate Flow Sensor** button. Follow the on-screen instructions and prompts. See “Flow Sensor Calibration” on page 7-5 for more information. Note that information for the last flow sensor calibration is displayed beside the button.

### Leak Test / Compliance

The **Test Leak / Compliance** button enables the A7 System to perform an automatic leak test and manual leak test, and calculates the compliance for the A7.

To perform a leak test, select the **Test Leak/Compliance** button. Follow the on-screen instructions and prompts. See “Leak and Compliance Tests” on page 4-8 for more information. Note that information for the last Leak Test / Compliance is displayed beside the button.

### Breathing System Warmer

To set the breathing system warmer, select **Warmer On** (default) or **Warmer Off**. If the warmer is off or if AC power is not connected, the system displays an icon to indicate that the warmer is not active (see FIGURE 3-44).



**FIGURE 3-44** Warmer Inactive Icon

After cycling power, the breathing system warmer will return to the default state.

**NOTE:**        **The breathing system warmer is inactive when the A7 is powered by the battery supply.**

## Zero Flow Meters

To zero the flow meters, select the **Zero Flow Meters** button. Follow the on-screen instructions and prompts. Note that information for the last zeroing of the flow meters is displayed beside the button.

**NOTE:**        **Before zeroing the flow meters, make sure to disconnect the gas supply (O<sub>2</sub>, N<sub>2</sub>O, Air).**

## Gas Bench Flow Rate

Set Gas Bench Flow Rate to High, Med or Low (default).

## Balance Gas

Set Balance Gas to None, N<sub>2</sub>O or AIR (default).

## Fresh Gas Control

Set Fresh Gas Control to Direct Flow or Total Flow (default).

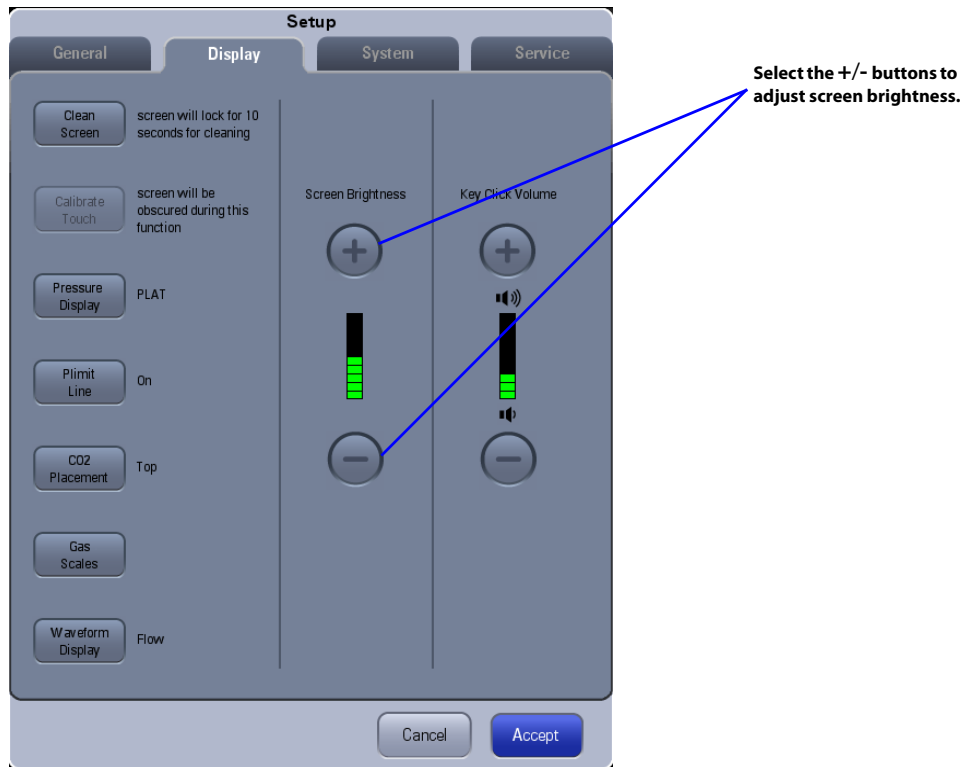
## 3.11 Display Tab

The **Display** tab provides access to screen cleaning, screen calibration, pressure parameter display, CO2 waveform placement, gas scales, waveform display, screen brightness and key click volume (see FIGURE 3-45).

### Screen Brightness

To adjust the screen brightness:

1. Select **Setup** softkey > **Display** tab (See FIGURE 3-45).
2. In the **Screen Brightness** area, select the +/- buttons to adjust the screen brightness.
3. Select the **Accept** button to confirm the change, or select **Cancel** to discard the change.

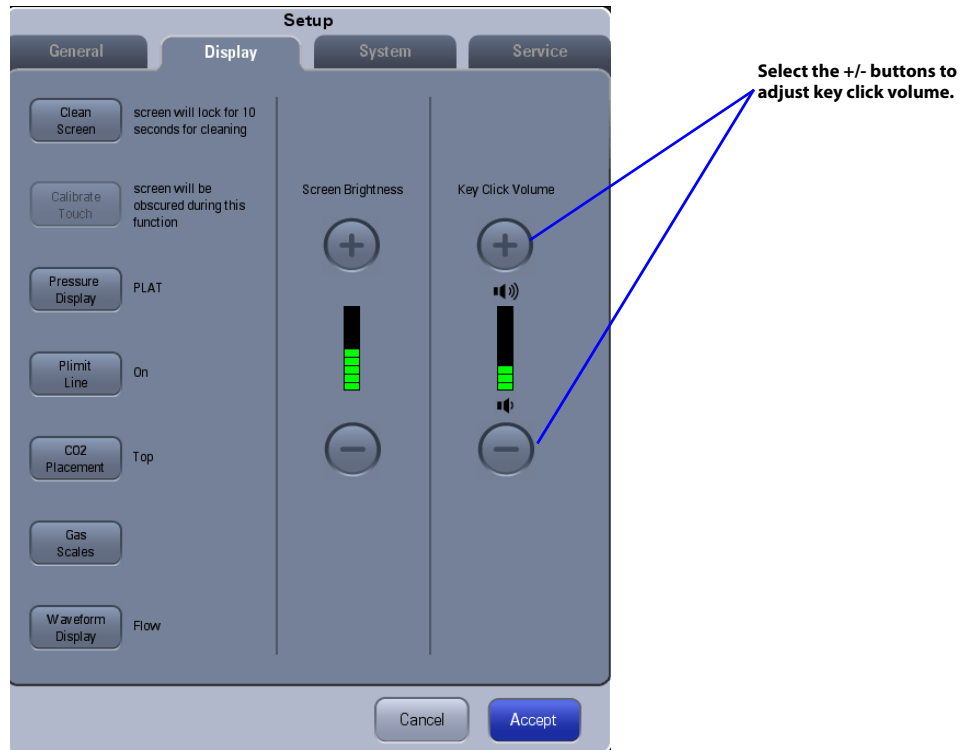


**FIGURE 3-45** Display Tab > Screen Brightness Area

## Key Click Volume

To adjust the key click volume:

1. Select **Setup** softkey > **Display** tab.
2. In the **Key Click Volume** area, select the +/- buttons to adjust the key click volume.
3. Select the **Accept** button to confirm the change, or select **Cancel** to discard the change.



**FIGURE 3-46** Display Tab > Key Click Volume Area

## Clean Screen

To clean the LCD touch screen:

1. Select **Setup** softkey > **Display** tab.
2. Select the **Clean Screen** button.  
The screen locks for 10 seconds for cleaning.

## Calibrate Touch

To calibrate the LCD touch screen:

1. Select **Setup** softkey > **Display** tab.
2. Select the **Calibrate Touch** button.
3. Follow the on-screen instructions.

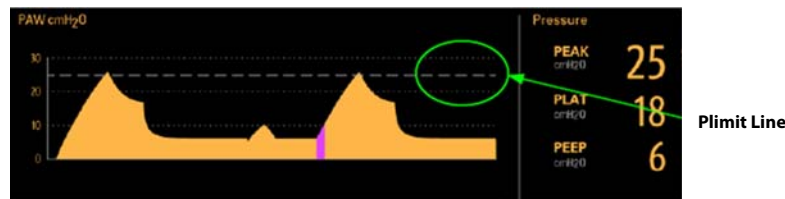
## Pressure Display

To change the pressure display:

1. Select **Setup** softkey > **Display** tab.
2. Select the **Pressure Display** button.
3. Choose between **MEAN** and **PLAT**.
4. Select the **Accept** button to confirm the change, or select the **Cancel** button to discard the change.

## Plimit Line

The Plimit line function displays a dashed line in the Pressure waveform area to indicate the Plimit position. The Plimit line can be displayed in VCV, SIMV-VC, and PCV with VG on mode. The user may turn the Plimit line On or Off. The default value for Plimit Line is On.



**FIGURE 3-47** Plimit Line

**NOTE:** The Plimit line does not affect the auto-scaling algorithm. If the Plimit line is turned on but not visible, it may be because the line is positioned off the waveform scale.

To set the Plimit Line to ON or OFF:

1. Select **Setup** softkey > **Display** tab.
2. Select the **Plimit Line** button to ON or OFF.
3. Select the **Accept** button to confirm the change, or select the **Cancel** button to discard the change.

## CO<sub>2</sub> Placement

The CO<sub>2</sub> waveform/data can be positioned at the top or bottom of the Waveform area.

To set the CO<sub>2</sub> Placement:

1. Select **Setup** softkey > **Display** tab.
2. Select the **CO<sub>2</sub> Placement** button.
3. Choose between **TOP** and **Bottom**.
4. Select the **Accept** button to confirm the change, or select the **Cancel** button to discard the change.

## Gas Scales

To set the Gas scales:

1. Select **Setup** softkey > **Display** tab.
2. Select the **Gas Scales** button.

3. Select the **CO<sub>2</sub> Scale**, **AA Scale**, **O<sub>2</sub> Scale** or **N<sub>2</sub>O Scale** button. If an aesthetic agent, such as sevoflurane, is detected, the system displays **Sev Scale** instead of **AA Scale**.
4. Select the desired scale setting according to the table below:

GAS SCALES	UNIT OF MEASURE	SCALE		
CO <sub>2</sub> Scale	mmHg	0-40	0-60	0-80
	kPa	0.0-5.0	0.0-8.0	0.0-10.0
	%	0.0-5.0	0.0-8.0	0.0-10.0
O <sub>2</sub> Scale	%	0-35	0-50	0-100
N <sub>2</sub> O Scale	%	0-35	0-50	0-100
Des Scale	%	0.0-6.0	0.0-9.0	0.0-18.0
Sev Scale	%	0.0-2.0	0.0-4.0	0.0-8.0
Iso Scale	%	0.0-1.2	0.0-2.5	0.0-5.0
Hal Scale	%	0.0-1.2	0.0-2.5	0.0-5.0
Enf Scale	%	0.0-1.2	0.0-2.5	0.0-5.0

**TABLE 3-8** Gas Scales

5. If needed, select the **Load Scales Defaults** button and then select the **Yes** button to restore the factory default configurations. Select the **Accept** button to confirm the change, or select the **Cancel** button to discard the change.

GAS SCALE	FACTORY DEFAULT SCALE		
CO <sub>2</sub> Scale	0-60 mmHg	0.0-8.0 kPa	0.0-8.0 %
O <sub>2</sub> Scale	0-100 %		
N <sub>2</sub> O Scale	0-100 %		
Des Scale	0-9.0 %		
Sev Scale	0-4.0 %		
Iso Scale	0-2.5 %		
Hal Scale	0-2.5 %		
Enf Scale	0-2.5 %		

**TABLE 3-9** Factory default scale

## Waveform Display

To set the waveform display:

1. Select **Setup** softkey > **Display** tab.
2. Select the **Waveform Display** button.
3. Select the desired waveform.
4. Select the **Accept** button to confirm the change, or select the **Cancel** button to discard the change.

## 3.12 System Tab

The **System** tab is accessible only by authorized administrative service personnel with password access. The system tab can only be accessed in **Standby** mode.

**NOTE:** The default System tab password is: 1234. The authorized administrator should change the default password immediately after the system is installed to prevent unauthorized access to the System tab. The password can be maximum of 6 digits in length containing numerals 0 to 9.



**FIGURE 3-48** Setup Menu > System Tab

SYSTEM TAB BUTTON	CHOICES	DESCRIPTION
<b>Calibrate</b>	<b>External AG Module</b> <b>Internal AG Module</b>	Select to calibrate the External AG Module or Internal AG Module. Follow the screen instructions.
<b>Language</b>	<b>ENGLISH</b> (default) <b>CHINESE</b> <b>FRENCH</b> <b>SPANISH</b>	Select to set the user interface text language.

**TABLE 3-10** System Tab Settings





SYSTEM TAB BUTTON	CHOICES	DESCRIPTION
<b>Default Settings</b>	<b>Default Patient Size</b> (default= <b>Infant, Adult, Pediatric</b> )	Select to set the default patient size.
	<b>Default Vent Mode</b> (default= <b>VCV, SIMV-VC, PCV, SIMV-PC, PS</b> )  <b>NOTE: Default changes take effect after next case or when O.R. defaults are loaded.</b>	Select to set the default mechanical ventilation mode. For default changes to take effect: 1. Press Accept. 2. Start next case. 3. End case.
<b>Manage Defaults</b>	<b>Save Defaults</b> <b>Save as O.R. Defaults</b>	Select <b>Save Defaults</b> or <b>Save as O.R. Defaults</b> to save the current configuration as the user default configuration.
	<b>Load User Defaults</b> <b>Load O.R. Defaults</b>	Select <b>Load User Defaults</b> or <b>Load O.R. Defaults</b> to load the user default configuration.
	<b>Restore Partial Defaults</b>	Select <b>Restore Partial Defaults</b> to overwrite the user defaults and system settings with the factory default settings. Note that network settings will not be restored.
	<b>Import Defaults</b>	Select <b>Import Defaults</b> to import a copy of the defaults from the USB mass storage device if one has been inserted into an SB port at the rear of the A7 unit.
	<b>Export Defaults</b>	Select <b>Export Defaults</b> to export a copy of the defaults to the USB mass storage device if one has been inserted into an SB port at the rear of the A7 unit.

**TABLE 3-10** System Tab Settings

SYSTEM TAB BUTTON	CHOICES	DESCRIPTION
<b>Time Settings</b>	<b>Time Zone</b> (Default = <b>UTC-05:00</b> )	Select to set the UTC time zone offset.
	<b>Daylight Savings</b> (Default = <b>Manual, Auto</b> )	Select to set the Daylight Savings Time (DST) to be adjusted automatically by the A7 System, or manually by the authorized administrator. If the region or country of installation does not observe DST, change this setting to Manual. If Daylight Savings is set to Auto, the Daylight Savings Time On/Off button in the Date/Time dialog becomes inactive and cannot be selected (see FIGURE 3-11)
	<b>DST Start</b> (Default = <b>First Sunday in April at 2:00 AM</b> )	Select to set the START of Daylight Savings Time. This setting is not available if DST is set to Manual.
	<b>DST End</b> (Default = <b>Last Sunday in October at 3:00 AM</b> )	Select to set the END of Daylight Savings Time. This setting is not available if DST is set to Manual.
<b>Network</b>	See section 3.12.1 (page 3-47) "Network Configuration".	
<b>Change Password</b>	<b>1234</b> (default)	Select to change the <b>System</b> tab password. The authorized administrator should change the default password immediately after the system is installed to prevent unauthorized access to the <b>System</b> tab. The password can be up to 6 digits in length containing numerals 0 to 9.
<b>Units</b>	<b>Pressure</b> (default= <b>cmH<sub>2</sub>O, hPa, mbar</b> )	Select to set the Pressure unit of measure.
	<b>CO<sub>2</sub></b> (default= <b>mmHg, kPa, %</b> )	Select to set the CO <sub>2</sub> unit.
		<b>NOTE: The Set CO<sub>2</sub> Unit button only displays if an external AG module is connected to the A7.</b>

**TABLE 3-10** System Tab Settings

SYSTEM TAB BUTTON	CHOICES	DESCRIPTION
<b>Configuration Information</b>	—	Select to display the machine ID and the status of system functions. 
<b>Export Data</b>	—	Select to export patient data via mass storage device.
<b>Clear History</b>	<b>On</b> <b>Off</b> (default)	Select to configure the Clear History setting at the end of the case. When turned on, event logs and all trends will be deleted at the start of the case. When turned off, event logs and all trends will not be deleted at the start of the case. 

**TABLE 3-10** System Tab Settings

SYSTEM TAB BUTTON	CHOICES	DESCRIPTION
<b>Optimizer®</b> (software bundle version 02.09.00 and later)	<b>On</b> (default) <b>Off</b>	Select to turn on or off the OPTIMIZER® .
<b>Optimizer®</b> (software bundle version 02.11.00 and later)	<b>Optimizer®</b> (default= <b>On, Off</b> )  <b>Cost/ml of Liquid Agent</b>	Select to turn on or off the fresh gas flow OPTIMIZER® and the agent usage/ cost meter.  Select to set the cost of the agent per ml.

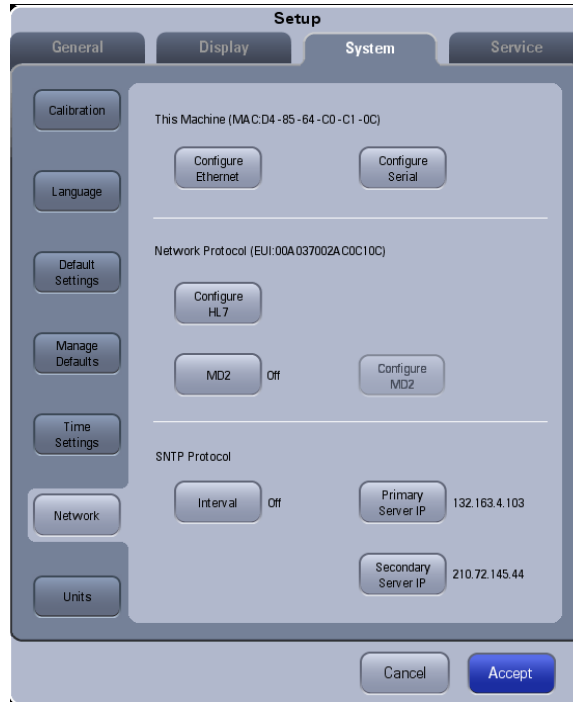


**NOTE:** If cost is set to zero then the cost of the agent per ml will not be displayed.

**TABLE 3-10** System Tab Settings

### 3.12.1 Network Configuration

Network configuration settings can be set via the **Network** button (see FIGURE 3-49):  
 Select main screen > **Setup** button > **System** tab > **Network** button.



**FIGURE 3-49** Network Configuration Screen

TABLE 3-11 lists the network settings and parameters.

SETTINGS	PARAMETERS
<b>This Machine</b>	
Configure Ethernet	Enter: • IP Address (default = <b>192.168.23.250</b> ) • Subnet (default = <b>255.255.255.0</b> ) • Default Gateway (default = <b>[blank]</b> )

**SETTINGS**

Configure Serial

**PARAMETERS**

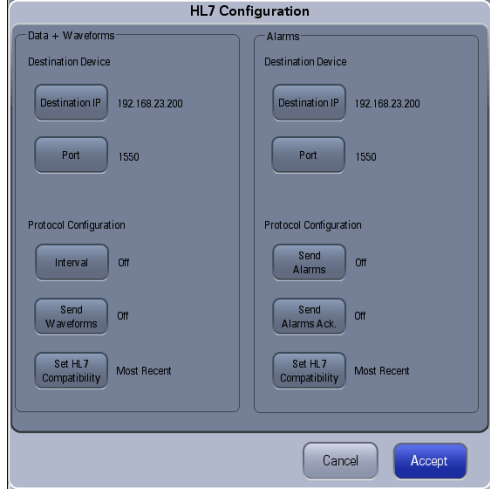
Select:

- Protocol (**None** (default), HL7, MR-WATO, Philips (software bundle version 02.09.00 and later))
- Baud Rate (57600, **11520** (default))
- Data Bits (**8** (default), 7, 6, 5)
- Stop Bits (**1** (default), 2)
- Parity (Odd, Even, **None** (default))
- Interval:
  - Enabled when Protocol=None: **Off** (default);
  - Enabled when Protocol=HL7: 10 Sec, 30 Sec, **1 Min** (default), 5 Min, 30 Min, 1 Hour, 2 Hour, 6 Hour, 12 Hour, 24 Hour.

**NOTE:** When Protocol is set to MR-WATO, the A7 can communicate with the patient monitor of Mindray through Benelink module of Mindray.

**NOTE:** When Protocol is set to Philips, the A7 can communicate with the patient monitor of Philips through IntelliBridge or VueLink module of Philips.

**Network Protocol**

SETTINGS	PARAMETERS
Configure HL7	Interval(10 sec, 30 sec, 1 min (default), 5 min, 30 min, 1 hour, 2 hour, 6 hour, 12 hour, 24 hour) Destination IP (default = 192.168.23.200) Port (default = 1550) Set HL7 Compatibility(Most Recent (Default), 02.02.01 to 02.10.00, 02.00.00, 01.05.02, 01.00.00 to 01.05.01, None) Send Waveforms(Off(Default), On) Send Alarms(Off(Default), On) Send Alarm Ack.(Off(Default), On)
	
MD2 (software bundle version 02.09.00 and later)	Select: On, Off (default)
	<b>NOTE: MD2 is a communication protocol. The A7 can connect to the eGateway through MD2, and communicates with the devices connected to the eGateway.</b>
Configure MD2 (enabled when MD2 = On)	Destination IP (default = 192.168.23.99) Port (default = 6678)
SNTP Protocol	
Interval	Select: <b>Off</b> (default), 10 sec, 30 sec, 1 min, 5 min, 30 min, 1 hour, 2 hour, 6 hour, 12 hour, 24 hour
Primary Server IP	Enter: Primary Server IP (default = <b>132.163.4.103</b> )
Secondary Server IP	Enter: Secondary Server IP (default = <b>210.72.145.44</b> )

**TABLE 3-11** Network Configuration Settings and Parameters

## 3.13 Service Tab

Accessible only by Mindray-authorized service personnel. Please contact Mindray Technical Support for assistance.

**This page intentionally left blank.**



# **Preoperative Tests**

---

Preoperative Test Schedules .....	4-2
Inspect the System .....	4-3
Pre-Operative Checkout List.....	4-4
System Self-Test .....	4-6
Leak and Compliance Tests .....	4-8
Automatic Backup Flow Control Test.....	4-16
Preoperative Check List (software bundle version 02.09.00 and later).....	4-18
Pipeline Tests .....	4-19
Basic Ventilation Testing .....	4-20
Cylinder Tests.....	4-21
Flow Control System Test.....	4-22
Vaporizer Tests .....	4-23
Breathing System Tests .....	4-25
Alarm Tests.....	4-27
Preoperative Preparations .....	4-29
Inspect the Active AGSS .....	4-30
Inspect the Negative Pressure Suction Device .....	4-30

## 4.1 Preoperative Test Schedules

Preoperative tests on the A7 follow the ASA guidelines and should be performed according to the test intervals listed below. Refer to special procedures or precautions in this manual.

**NOTE:** This is a guideline which can be modified to accommodate variations in local clinical practice. Such local modifications should have appropriate peer review.

**NOTE:** Ensure that the N<sub>2</sub>O cutoff and O<sub>2</sub>/N<sub>2</sub>O ratio are normal before use. Use an O<sub>2</sub> concentration tester to monitor the O<sub>2</sub> concentration in the gas output.

### 4.1.1 Test Intervals

Perform the preoperative tests listed below at these events:

- **When required after a maintenance or service procedure**
- **Every day before the first patient:**
  - System Self-Test (Section 4.4)
  - Leak and Compliance Tests (Section 4.5)
  - Pipeline Tests (Section 4.9)
  - Basic Ventilation Testing (Section 4.10)
  - Cylinder Tests (Section 4.11)
  - Flow Control System Test (Section 4.12)
  - Vaporizer Tests (Section 4.13)
- **Before each patient:**
  - Inspect the System (Section 4.2)
  - Pre-Operative Checkout List (Section 4.3)
  - Perform the Leak/Compliance Test (Section 4.5)
  - Automatic Backup Flow Control Test (Section 4.6)
  - Preoperative Check List (software bundle version 02.09.00 and later) (Section 4.7)
  - Breathing System Tests (Section 4.14)
  - Alarm Tests (Section 4.15)
  - Preoperative Preparations (Section 4.16)
  - Inspect the Active AGSS (Section 4.17)
  - Inspect the Negative Pressure Suction Device (Section 4.18)

**NOTE:** Read and understand the operation and maintenance of each component before using the A7 anesthesia machine.

**NOTE:** Do not use the A7 anesthesia machine if a test failure occurs. Contact Mindray Technical Support for assistance.

**NOTE:** Provide a checklist of the anesthetic system, including anesthetic gas delivery system, monitoring device, alarm system, and protective device, which are intended to be used for the anesthetic system, whether they are used alone or assembled together.

## 4.2 Inspect the System

**NOTE:** Ensure that the breathing system is correctly connected and not damaged.

Perform the following inspection checklist before operating the A7 unit:

1. The A7 anesthesia machine is correctly connected and undamaged.
2. Inspect the system for:
  - a. Damage to flowmeters, vaporizers, gauges, supply hoses
  - b. Complete breathing system with adequate CO<sub>2</sub> absorbent Pre-Pak or loose fill
  - c. Correct mounting of cylinders in yokes
  - d. Presence of cylinder wrench
  - e. Auxiliary O<sub>2</sub> supply, available and functioning
3. Check that:
  - a. Gas cylinders are turned off until needed to prevent the unintended use of gases
  - b. Vaporizers are off
  - c. Vaporizers are filled (not overfilled)
  - d. Filler caps are sealed tightly
  - e. Only one vaporizer can be turned on at the same time
4. All components are correctly attached.
5. The breathing system is correctly connected, the breathing tubes are undamaged, and the self-inflating manual ventilation device is available and functioning.
6. The gas supplies are connected and the pressures are correct.
7. Cylinder valves are closed on models with cylinder supplies (Verify that the cylinder wrench is attached).
8. The necessary emergency equipment is available and in good condition.
9. Equipment for airway maintenance and tracheal intubation is available and in good condition.
10. Inspect the color of the soda lime in the canister. Replace the soda lime immediately if obvious color change is detected. The soda lime is white when new. If it is purple, it must be changed.

**WARNING:** Check if the gasket is properly installed in place while installing the absorber canister. If the gasket is not properly installed (for example, gasket is not evenly seated and centered) it may cause breathing system leakage.

11. Applicable anesthetic and emergency drugs are available.
12. The casters are not damaged or loose, and the brake(s) is set and prevents movement.
13. Ensure the breathing system is in proper position.
14. The AC mains indicator and the battery indicator are displayed when the power cord is connected to the AC power source. If the indicators are not displayed, the system does not have electrical power.
15. The A7 anesthesia machine is switched on or off normally.

## 4.3 Pre-Operative Checkout List

### 4.3.1 Introduction

The purpose of the pre-operative checkout is to detect potential system problems before use.

An effective method for detecting pneumatic circuit occlusions, leaks, and other system problems can be found in the A7 pre-operative checkout procedures. In addition, it is recommended that the breathing circuit be tested for the ability to effectively deliver positive pressure ventilation before beginning each case. Testing the ability to properly ventilate a test lung can quickly identify an occluded circuit limb and other breathing circuit problems.

Before starting each case, test the machine's ability to ventilate the patient by removing the breathing bag from the bag arm and connecting it to the patient connection (elbow or Y-piece on the disposable circuit). Set the ventilator to deliver a specific tidal volume to the test lung and verify the exhaled tidal volume monitor. Observe that the test lung (breathing bag) inflates as the bellows descends, and that the test lung deflates during the exhalation phase. Observe that the measured exhaled volume matches the tidal volume set on the ventilator. With the ventilator running, lower the fresh gas flow to zero and observe if the bellows rapidly falls with each exhalation. If this occurs, then a leak should be suspected, identified, and repaired.

This test should be performed before starting each case. By verifying that a test lung (breathing bag) can be manually and mechanically ventilated, this indicates that the A7 is capable of ventilating a patient with the attached breathing circuit.

### 4.3.2 Suggested Pre-Operative Checkout List

Below is a suggested checkout list that should be conducted before administering anesthesia. This is a guideline which users are encouraged to modify according to their local clinical practice. Such local modifications should have appropriate peer review. Users should refer to the A7 operating instructions for special procedures, precautions, and step-by-step instructions.

**WARNING:** To ensure proper machine operation, user safety, and patient safety, follow all checkout procedures established by the facility before administering anesthesia to the patient.

**WARNING:** Refer to the procedure "Preparation for Malignant Hyperthermia Susceptible Patients" on page F-1 before applying A7 to malignant hyperthermia susceptible patients.

**Each day before administering anesthesia, the following should be done:**

1. With the anesthesia machine connected to AC Power, turn the Mains switch to ON and verify that the unit is operating on AC. Follow the on-screen prompts to perform and complete the automatic machine start-up tests.
2. a. Check the O<sub>2</sub> Supply fail-safe message and alarm.  
(See "O<sub>2</sub> Pipeline Test" on page 4-19.)  
b. Test low O<sub>2</sub> concentration alarm.  
(See "Test the O<sub>2</sub> Concentration Monitoring and Alarms" on page 4-28.)  
c. Test high and low airway pressure alarms.  
(See "Test the High Paw Alarm" on page 4-29.)  
(See "Test the Low Paw Alarm" on page 4-29.)  
d. Test low minute volume and apnea alarms.  
(See "Test the Low Minute Volume (MV) Alarm" on page 4-28.)  
(See "Test the Apnea Alarm" on page 4-28.)

3. Check that the vaporizers are properly installed and sufficiently filled and that filler ports are tightly closed. Verify that only one vaporizer turns ON at a time (see "Install the Vaporizer" on page 2-5).
4. Perform a 40 cmH<sub>2</sub>O manual leak test. If present, set the left vaporizer to ON and perform a 40 cmH<sub>2</sub>O manual leak test. Set the vaporizer to OFF. Repeat for the right vaporizer if installed (see "Manual Leak Test" on page 4-24).
5. Perform a vaporizer leak test for each vaporizer installed on the A7 System (see "Vaporizer Leak Test" on page 4-24).
6. Check that AGSS float moves freely. Set the vacuum flow so that the float position is between the Min and Max lines (see "Inspect the Active AGSS" on page 4-30).
7. Drain any moisture from the breathing system water trap and the condensation drain valve at the bottom of the absorber canister assembly.

**Prior to each patient, before administering anesthesia, the following should be done:**

1. Inspect the A7 for damage or hazardous conditions; check all necessary equipment and supplies are present, e.g., drugs, CO<sub>2</sub> absorbent (not exhausted), breathing circuits and tank wrench.
2. Check that central supply O<sub>2</sub>, N<sub>2</sub>O and Air pressures are each within the pipeline input range specifications (i.e., 40 to 87 psi).
3. Perform the flow control system test (see "Flow Control System Test" on page 4-22).
4. Perform a vaporizer leak test for each vaporizer installed on the A7 System (see "Vaporizer Leak Test" on page 4-24).
5. Verify that Auxiliary O<sub>2</sub> and Air are available and functioning.
6. Verify that a Self-inflating Manual Ventilation device is available and functioning.
7. Check that the O<sub>2</sub>, N<sub>2</sub>O and Air cylinders (if present) are mounted on the A7, have adequate pressure, and no high pressure leaks are present (see "Cylinder Tests" on page 4-21).
8. Check that valves on the O<sub>2</sub>, N<sub>2</sub>O, and Air cylinders (if present) are closed until needed to prevent unintentional use of gas.
9. With a breathing circuit and reservoir bag attached, check that the unidirectional valves operate by visual inspection.
10. Check ventilation capability in Standby, Manual, VCV and PCV ventilator modes.
11. Check that patient suction is adequate to clear the airway.
12. Verify ability of required monitors and check alarms.

**The following step is recommended to be performed weekly, whenever a new vaporizer is installed or when CO<sub>2</sub> absorbent is replaced:**

- Perform a vaporizer leak test (see "Vaporizer Leak Test" on page 4-24).

## 4.4 System Self-Test

When the A7 is powered on, it performs a self-test to ensure its alarm system (alarm LED, speaker, and buzzer) and hardware (flowmeter board, ventilator board, assistant ventilator board, power board, and CPU board) are properly functioning.

### Perform a System Self-test:

#### Self-test passed

1. Turn the system switch on the front panel to the **ON** position. The A7 powers up and begins its system self-test. See TABLE 4-1 for the system self-test sequence.

After completing the system self-test, the test results display on the screen. Startup alarm messages may also display.


See TABLE 4-2 for a list of possible test result conditions.

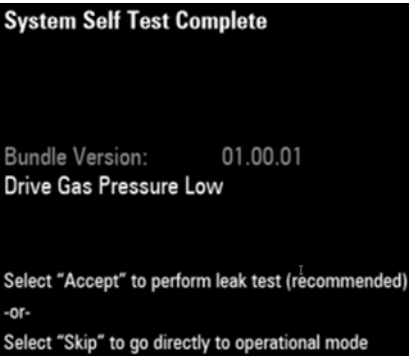
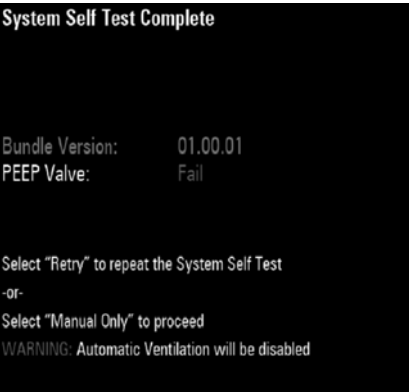
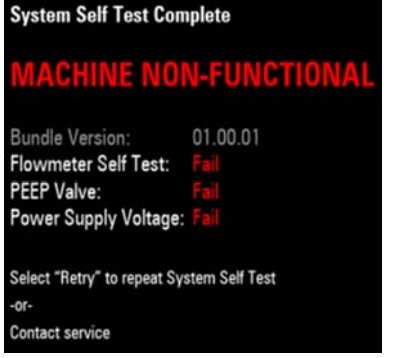
See "Startup Alarm Messages" on page 6-17 for a list of startup alarm messages.

2. Proceed to operate or troubleshoot the A7 based on the self-test results.

SYSTEM SELF-TEST SEQUENCE	COMMENTS
1. A high-pitched beep sounds.	Alarm self-test
2. The A7 startup screen displays.	
3. The LED above the touchscreen illuminates in sequence: red, yellow, and blue .	Alarm self-test
4. A test low priority alarm sounds.	Alarm self-test
5. The System Self-Test progress bar displays.	
6. The System Self-Test automatically starts.	Hardware self-test
7. The results of the System Self-Test displays.	

**TABLE 4-1** A7 System Self-Test Sequence

RESULT	COMMENTS/OPTIONS
<p><b>Pass</b> condition</p> <p>Example:</p> 	<p>The <b>Pass</b> condition indicates that the A7 passed the System Self-Test. No errors have been detected. Alarms and hardware are functioning properly.</p> <p>Select <b>Continue</b> to enter the Automatic Circuit Leak and Compliance Test screen.</p> <p>or</p> <p>Select <b>Skip</b> to enter the <b>Standby</b> mode with automatic ventilation enabled.</p>

RESULT	COMMENTS/OPTIONS
<p><b>All-Functional</b> error condition Example:</p> 	<p>The <b>All-Functional</b> error condition indicates that errors have been detected. However, all automatic ventilation, manual, and bypass modes are still enabled.</p> <p>Select <b>Accept</b> to enter the Automatic Circuit Leak and Compliance Test screen. or Select <b>Skip</b> to enter the main screen with automatic ventilation enabled,</p>
<p><b>Manual Only</b> error condition Example:</p> 	<p>The <b>Manual Only</b> error condition indicates that the A7 can be used in manual mode only.</p> <p>Select <b>Retry</b> to repeat the System Self-Test. or Select <b>Manual Only</b> to place the device in manual ventilation mode only. The following low priority alarm displays on the main screen: <b>Automatic Ventilation Disabled.</b></p> <p><b>WARNING: Selecting the Manual Only button will disable automatic ventilation.</b></p>
<p><b>Machine Non-Functional</b> error condition Example:</p> 	<p>The <b>Machine Non-Functional</b> error condition indicates that the A7 cannot be used.</p> <p>Select <b>Retry</b> to repeat the System Self-Test. or Contact service if this error condition persists.</p> <p><b>NOTE: Service Access button: The Service Access button is only available to Mindray-authorized service personnel and requires a service password.</b></p>

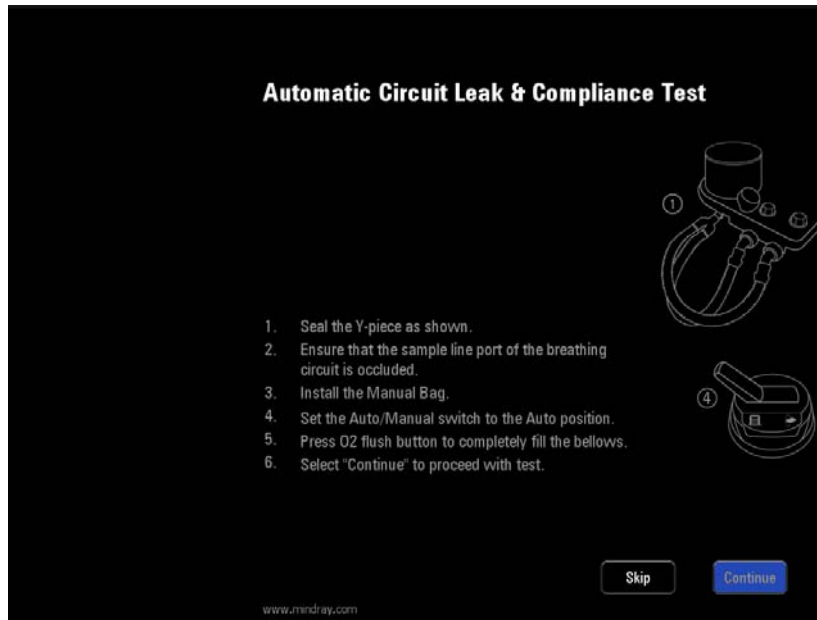
**TABLE 4-2** Types of System Self-Test Results

**Bundle Version** – The Bundle Version is displayed in all System Self-Test results. The Bundle Version is the version number of the package of software that is installed in the A7. If the Bundle Version displays a fail status, contact Mindray Technical Support.

## 4.5 Leak and Compliance Tests

### 4.5.1 Automatic Circuit Leak and Compliance Test

The Automatic Circuit Leak Test screen is displayed in FIGURE 4-1.



**FIGURE 4-1** Automatic Circuit Leak Test

### To Perform an Automatic Circuit Leak Test:

**NOTE:** The A7 System records the result of the last Automatic Circuit Leak Test in the General tab, including if the test had passed, failed, or was skipped. To access this information, from the main screen, select the Setup softkey > General tab.

**NOTE:** If the system detects fresh gas before proceeding with the Automatic Circuit Leak & Compliance Test, a message is displayed on the screen to adjust all flowmeters to zero.

1. *From power up:*  
While powering on the A7, the system automatically initiates a self-test and enters the **Preoperative Check List** screen. Select **Continue** to enter the **Automatic Circuit Leak Test** screen, followed by the **Manual Circuit Leak Test** screen. If the **Skip** button is selected, the system bypasses the **Automatic Circuit Leak Test** and the **Manual Circuit Leak Test** and enters the Standby mode.

or

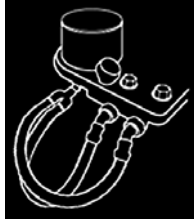
*From the main screen:*

Select the **Setup** softkey > **General** tab > **Test Leak/Compliance** button.



**2.** Follow the instructions on the screen:

## 1. Seal the Y-piece:



## 2. Ensure that the sample line port of the breathing circuit is occluded.

## 3. Install the manual bag.

4. Set the **Auto/Manual** switch to the **Auto** position:5. Press the **O<sub>2</sub>** flush button to completely fill the bellows.6. Select **Continue** to proceed with the **Automatic Circuit Leak Test**.

**NOTE:** The **Continue** button can be selected only when the **Auto/Manual** switch is set to the **Auto** position and when no fresh gas is detected.

**3.** Compare the test results with the information in TABLE 4-3, "Automatic Circuit Leak and Compliance Test Results," on page 4-10, and proceed accordingly.

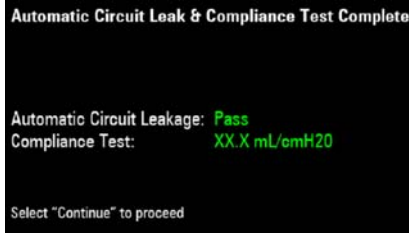
4.

**RESULTS**

**COMMENTS/OPTIONS**

Automatic Circuit Leakage: **Pass**  
 Compliance Test: **XX.X mL/cmH<sub>2</sub>O**  
 Example:

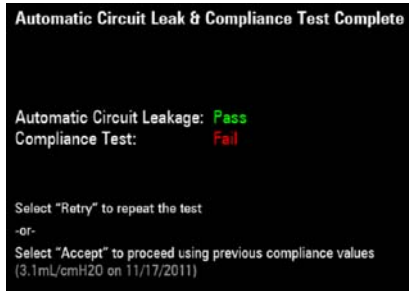
Leak rate ≤200 ml/min  
 Compliance test results display in green.



Select **Continue** to proceed to the **Manual Circuit Leak Test** screen.

Automatic Circuit Leakage: **Pass**  
 Compliance Test: **Fail**  
 Example:

Leak rate ≤200 ml/min  
 Compliance test failed.

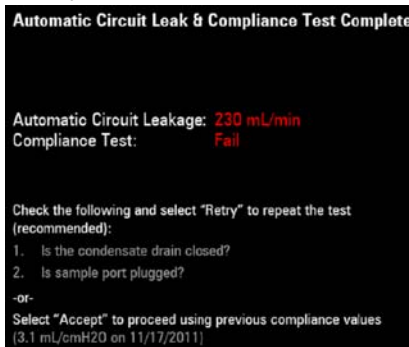


The results screen displays the compliance values and time of the last successful compliance test. Unsuccessful compliance tests display compliance values and test time as "----".

Select **Accept** to proceed to the **Manual Circuit Leak Test** screen and use the previous compliance values.  
 or  
 Select **Retry** to repeat the Automatic Circuit Leak Test & Compliance test.

Automatic Circuit Leakage: **XXX ml/min**  
 Compliance Test: **Fail**  
 Example:

Leak rate >200 ml/min and ≤1000 ml/min



The results screen displays the compliance values and time of the last successful compliance test. Unsuccessful compliance tests display compliance values and test time as "----".

Select **Accept** to proceed to the **Manual Circuit Leak Test** screen and use the previous compliance values.  
 or  
 Select **Retry** to repeat the Automatic Circuit Leak Test & Compliance test.

**TABLE 4-3** Automatic Circuit Leak and Compliance Test Results

**RESULTS****COMMENTS/OPTIONS**

Automatic Circuit Leakage: **Fail: Fresh gas flow detected**

Compliance Test: **Fail**

Example:



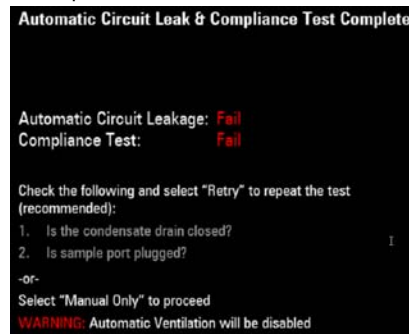
Fresh gas is detected. Approximate threshold for fresh gas detection is 0.15 L/min of gas flow.

Adjust all flowmeters to zero.  
Select **Retry** to repeat the test.

Automatic Circuit Leakage: **Fail**

Compliance Test: **Fail**

Example:



Leak rate >1000 ml/min.  
Fresh gas is not detected.

Follow on-screen instructions to troubleshoot the problem.  
or  
Select **Manual Only** to place the device in manual ventilation mode only. The following low priority alarm will be displayed on the main screen: **Auto Ventilation Disabled – Leak Test Failed:**

**WARNING:** Selecting the **Manual Only** button will disable automatic ventilation.

**MACHINE NON-FUNCTIONAL**

Safety valve control test or pressure verification test failed.

Automatic Circuit Leakage: **Pass**

Compliance Test: **XX.X mL/cmH<sub>2</sub>O**

Safety Valve Control: **Fail**

Example:

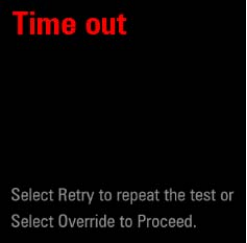
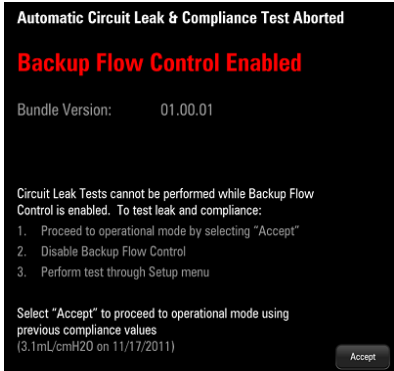


Select **Retry** to repeat the Automatic Circuit Leak Test & Compliance test.

or  
Contact service if this error condition persists.

**NOTE:** The **Service Access** button is only available to Mindray-authorized service personnel and requires a service password.

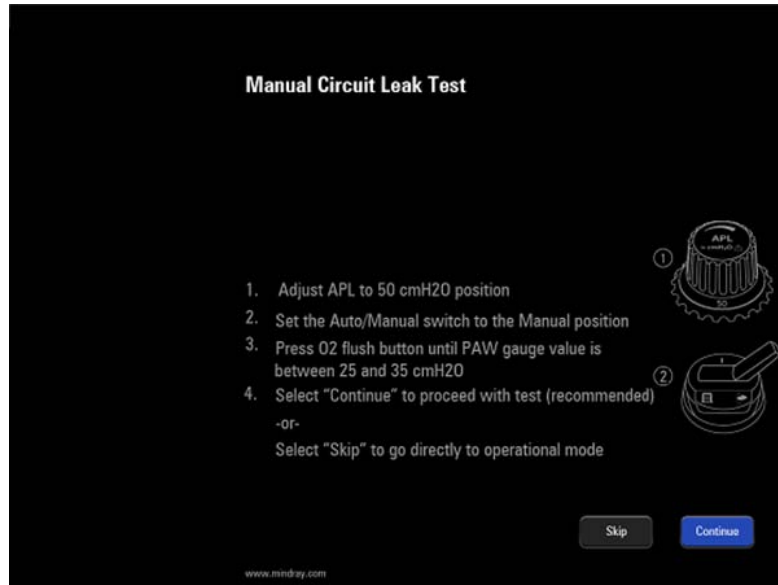
**TABLE 4-3** Automatic Circuit Leak and Compliance Test Results

RESULTS	COMMENTS/OPTIONS
<p><b>Time out</b> Example:</p> 	<p>Test results cannot be shown due to an internal communication error.</p> <p>Select <b>Retry</b> to repeat the Automatic Circuit Leak Test &amp; Compliance test. or Select <b>Override</b> to skip the test.</p>
<p><b>Backup Flow Control Enabled</b> Example</p> 	<p>For the A7 System, the backup flow control is active.</p> <p>Follow on-screen instructions to troubleshoot the problem. or Select <b>Accept</b> to proceed to operational mode using previous compliance values.</p>

**TABLE 4-3** Automatic Circuit Leak and Compliance Test Results

## 4.5.2 Manual Circuit Leak Test

The Manual Circuit Leak Test screen is displayed in FIGURE 4-2:



**FIGURE 4-2** Manual Circuit Leak Test screen

### To Perform a Manual Circuit Leak Test:

**NOTE:** If the system detects fresh gas before proceeding with the Manual Circuit Leak Test, a message is displayed on the screen to adjust all flowmeters to zero.

1. *From power up:*  
While powering on A7, the system automatically initiates a self-test and enters the **Preoperative Check List** screen. Select **Continue** to enter the **Automatic Circuit Leak and Compliance Test** and the **Manual Circuit Leak Test**. If the **Skip** button is selected, the system bypasses these tests and enters the Standby mode.

or

*From the main screen:*

Select the **Setup** softkey > **General** tab > **Test Leak/Compliance** button.


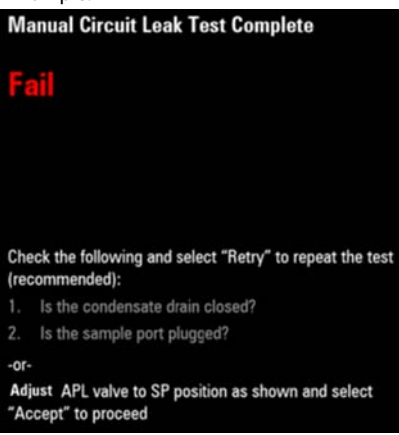
2. Follow the instructions on the screen:
  1. Adjust the **APL** to the 50 cmH<sub>2</sub>O position.
  2. Set the **Auto/Manual** switch to the **Manual** position.
  3. Press the **O<sub>2</sub>** flush button until the PAW gauge value is between 25 and 35 cmH<sub>2</sub>O.
  4. Select **Continue** to proceed with the **Manual Circuit Leak Test**.

or

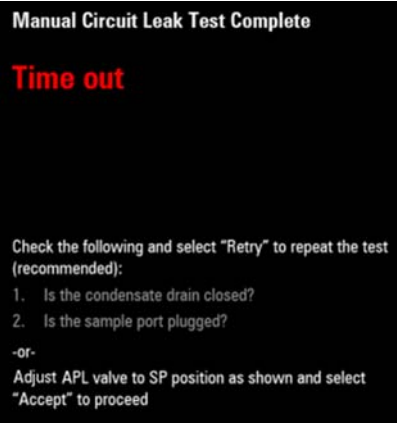
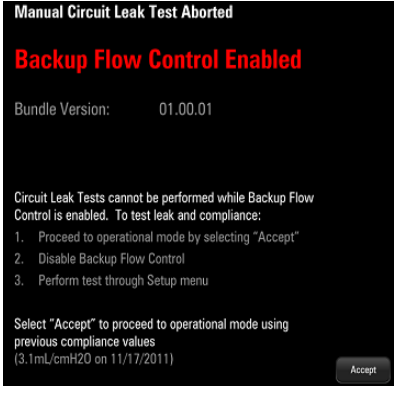
Select **Skip** to go directly to operational mode.

**NOTE:** The **Continue** button can be selected only when the Auto/Manual switch is set to the Manual position and when no fresh gas is detected.

3. Compare the test results with the information in TABLE 4-4, "Manual Circuit Leak Test Results," on page 4-14, and proceed accordingly.

RESULTS	COMMENTS/OPTIONS
<p><b>Pass</b> Example:</p>  <p>Adjust APL valve to SP position as shown and select "Continue" to proceed</p>	<p>Manual Circuit Leak Test passed.</p> <p>Adjust the APL valve to the SP position. Select <b>Continue</b> to proceed to the main screen.</p>
<p><b>Fail: Fresh gas flow detected</b> Example:</p>  <p>1. Adjust all flowmeters to zero 2. Select "Retry" to repeat the test</p>	<p>Manual Circuit Leak Test failed. Fresh gas is detected.</p> <p>Adjust all flowmeters to zero. Select <b>Retry</b> to repeat the test.</p>
<p><b>Fail</b> Example:</p>  <p>Check the following and select "Retry" to repeat the test (recommended):</p> <ol style="list-style-type: none"> <li>1. Is the condensate drain closed?</li> <li>2. Is the sample port plugged?</li> </ol> <p>-or-</p> <p>Adjust APL valve to SP position as shown and select "Accept" to proceed</p>	<p>Manual Circuit Leak Test failed. Fresh gas is not detected.</p> <p>Follow on-screen instructions to troubleshoot the issue. or Adjust APL valve to the SP position and select <b>Accept</b> to proceed to the main screen.</p>

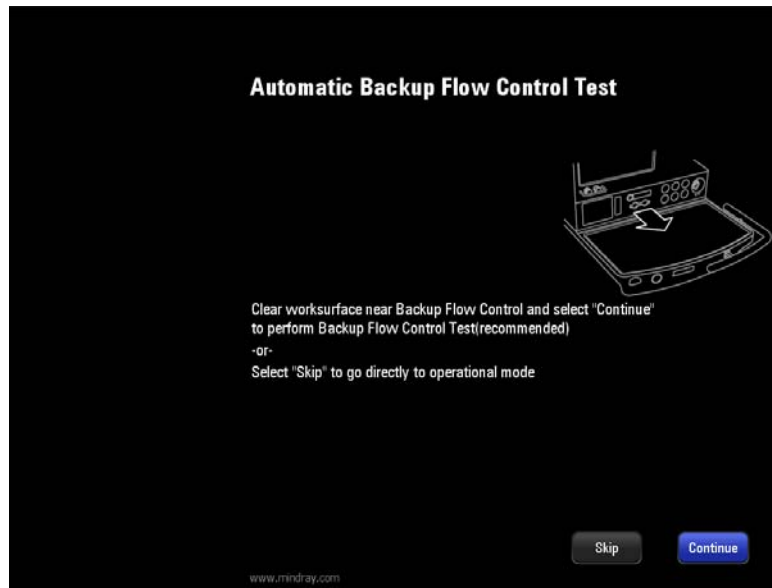
**TABLE 4-4** Manual Circuit Leak Test Results

RESULTS	COMMENTS/OPTIONS
<p><b>Time out</b> Example:</p> 	<p>Test result cannot be shown due to an internal communication error.</p> <p>Select <b>Retry</b> to repeat the Automatic Circuit Leak Test &amp; Compliance test. In certain rare instances, after pressing "Retry" the manual circuit leak test will be performed, but the progress bar will be blank and will not show that the manual leak test was completed. If this anomaly occurs, press the Cancel button on the screen to continue.</p> <p>or</p> <p>Select <b>Accept</b> to proceed.</p>
<p><b>Backup Flow Control Enabled</b> Example</p> 	<p>For the A7 System, the backup flow control is active.</p> <p>Follow on-screen instructions to troubleshoot the problem.</p> <p>or</p> <p>Select <b>Accept</b> to proceed to operational mode using previous compliance values.</p>

**TABLE 4-4** Manual Circuit Leak Test Results

## 4.6 Automatic Backup Flow Control Test

The Automatic Backup Flow Control Test screen is displayed in FIGURE 4-3:



**FIGURE 4-3** Automatic Backup Flow Control Test

### To Perform an Automatic Backup Flow Control Test:

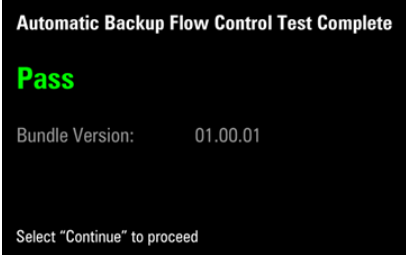
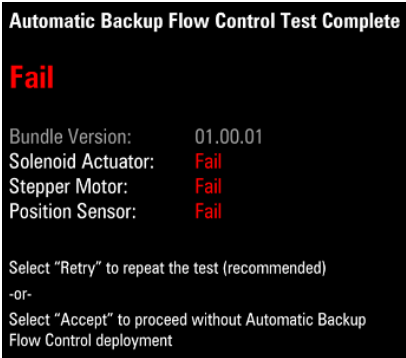
1. While powering on the A7, the system calculates the time between the last successful Automatic Backup Flow Control Test time and current time. If the difference between the two is greater than 168 hours, the manual circuit test screen is entered from startup and BFCS knob is not deployed, the system enters first Automatic Backup Flow Control Test screen when manual circuit test is completed.
2. Follow the instructions on the screen:  
Clear work surface near Backup Flow Control and select **Continue** to perform Backup Flow Control Test (recommended)

or

Select **Skip** to go directly to operational mode.



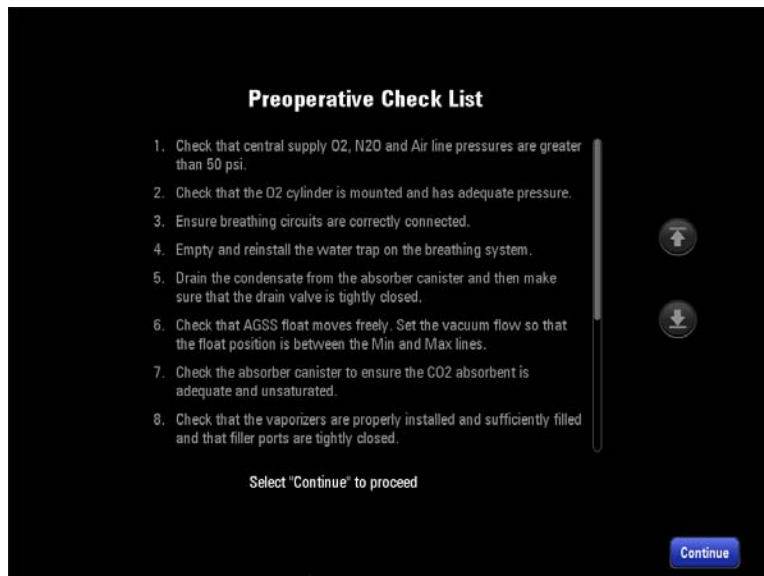
3. Compare the test results with the information in TABLE 4-5, "Automatic Backup Flow Control Test," on page 4-17, and proceed accordingly.

RESULTS	COMMENTS/OPTIONS
<p><b>Pass</b> Example:</p> 	<p>Automatic Backup Flow Control Test passed. Select <b>Continue</b> to proceed to the main screen.</p>
<p><b>Fail</b> Example:</p> 	<p>Automatic Backup Flow Control Test failed. Select <b>Retry</b> to repeat the test. or Select <b>Accept</b> to proceed without Automatic Backup Flow Control deployment.</p>

**TABLE 4-5** Automatic Backup Flow Control Test

## 4.7 Preoperative Check List (software bundle version 02.09.00 and later)

While powering on the A7, the system automatically initiates a self-test and enters the **Preoperative Check List** screen. Select **Continue** to proceed to Standby mode. The **Preoperative Check List** screen is displayed in FIGURE 4-4.



**FIGURE 4-4** Preoperative Check List

## 4.8 Power Failure Alarm Test

1. Set the system switch to the **ON** position.
2. Disconnect the AC mains.
3. Ensure that the AC mains indicator and battery charge indicator are extinguished. An audible alarm should sound and the prompt message **Battery in Use** should display on the main screen.
4. Reconnect the AC mains.
5. Ensure that an audible alarm sounds and the AC mains indicator and battery charge indicator illuminate. The prompt message **Battery in Use** should not be displayed on the main screen.
6. Set the system switch to the **OFF** position.

## 4.9 Pipeline Tests

**NOTE:** If the pipeline supply is unavailable, please use the cylinder.

### 4.9.1 O<sub>2</sub> Pipeline Test

1. Connect the O<sub>2</sub> pipeline supply.
2. Close all cylinder valves if the A7 anesthesia machine is equipped with cylinders.
3. Set the system switch to the **ON** position.
4. Set the O<sub>2</sub> flow to 6 L/min.
5. Ensure that the O<sub>2</sub> pipeline pressure gauges show 280 to 600 kPa (40 to 87 psi).
6. Disconnect the O<sub>2</sub> pipeline supply.
7. As O<sub>2</sub> pressure decreases, alarms for **O<sub>2</sub> Supply Failure** and **Drive Gas Pressure Low** should occur.
8. Ensure that the O<sub>2</sub> gauge decreases to zero.

### 4.9.2 N<sub>2</sub>O Pipeline Test

**NOTE:** When doing the N<sub>2</sub>O pipeline test, connect the O<sub>2</sub> supply first to enable N<sub>2</sub>O flow control.

**NOTE:** Different from O<sub>2</sub> pipeline supply, when N<sub>2</sub>O supply is disconnected, no alarms related to N<sub>2</sub>O pressure occur as N<sub>2</sub>O pressure decreases.

1. Connect the O<sub>2</sub> and N<sub>2</sub>O pipeline supplies.
2. Close all cylinder valves if the A7 anesthesia machine is equipped with cylinders.
3. Set the system switch to the **ON** position.
4. Select **Setup** softkey > **General** tab and set the **Fresh Gas Control** to **Direct Flow**.
5. Set the **Balance Gas** to **N<sub>2</sub>O**.
6. Set the N<sub>2</sub>O flow to 6 L/min.
7. Check that the N<sub>2</sub>O pipeline pressure gauges show 280 to 600 kPa (40 to 87 psi).
8. Disconnect the N<sub>2</sub>O pipeline supply.
9. As N<sub>2</sub>O pressure decreases, the alarm for "N<sub>2</sub>O Supply Failure" should occur. At the same time, the N<sub>2</sub>O flow is zero and the O<sub>2</sub> flow is not changed.

10. Ensure that the N<sub>2</sub>O gauge decreases to zero.

### 4.9.3 Air Pipeline Test

**NOTE:** Different from the O<sub>2</sub> pipeline supply, when the air pipeline supply is disconnected, no alarms related to air pressure occur as air pressure decreases.

1. Connect the Air pipeline supply.
2. Close all cylinder valves if the A7 anesthesia machine is equipped with cylinders.
3. Set the system switch to the **ON** position.
4. Select **Setup** softkey > **General** tab and set the **Fresh Gas Control** to **Direct Flow**.
5. Set the **Balance Gas** to **Air**.
6. Set the Air flow to 6 L/min.
7. Check that the Air pipeline pressure gauges show 280 to 600 kPa (40 to 87 psi).
8. Disconnect the Air pipeline supply.
9. As Air pressure decreases, the alarm for "Air Supply Failure" should occur.
10. Ensure that the Air gauge decreases to zero.

## 4.10 Basic Ventilation Testing

- a. Attach a breathing circuit and breathing bag.
- b. Attach an adult test lung or breathing bag to the patient end of the Y-fitting of the breathing circuit.
- c. Set the O<sub>2</sub> flow to 3 L/min and set the N<sub>2</sub>O and AIR flow rates to zero flow.
- d. Set the ventilator controls to:

VENTILATOR CONTROLS	VENTILATOR SETTINGS
Patient Type	Adult
Ventilation Mode	PCV
Tidal Volume Guarantee - <b>VtG</b>	Off
Target Pressure - <b>P<sub>INSP</sub></b>	20
Breath Rate - <b>freq</b>	8
I:E Ratio - <b>I:E</b>	1:2
PEEP - <b>PEEP</b>	Off
Inspiratory Slope - <b>T<sub>slope</sub></b>	0.5

- e. Select **PCV** and begin ventilation.
- f. Ensure that the breathing bag at the patient end of the Y-fitting of the breathing circuit inflates and deflates and that the PLAT on the display and the PAW gauge are consistent with the P<sub>target</sub> setting.

## 4.11 Cylinder Tests

**NOTE:** You do not need to perform cylinder tests if the A7 anesthesia machine is not equipped with cylinders.

### 4.11.1 Check the Cylinder Pressure

1. Set the system switch to the **OFF** position and connect the cylinders to be checked.
2. Open each cylinder valve using the supplied wrench.
3. Ensure that each cylinder has sufficient pressure. If not, close the applicable cylinder valve and install a full cylinder.  
O<sub>2</sub> cylinder input range: 6.9 to 15.5 MPa (1000 to 2250 psi)  
N<sub>2</sub>O cylinder input range: 4.2 to 6 MPa (600 to 870 psi)  
Air cylinder input range: 6.9 to 15.5 MPa (1000 to 2250 psi)
4. Close all cylinder valves.

### 4.11.2 O<sub>2</sub> Cylinder High Pressure Leak Test

1. Set the system switch to the **OFF** position and disconnect the O<sub>2</sub> pipeline supply.
2. Set the O<sub>2</sub> flow to zero.
3. Open the O<sub>2</sub> cylinder valve.
4. Record the current cylinder pressure.
5. Close the O<sub>2</sub> cylinder valve.
6. Record the cylinder pressure after one minute.  
If the cylinder pressure decreases more than 1.25 MPa (181 psi), install a new cylinder gasket. Repeat steps 1 through 6. If the leak continues, do not use the cylinder supply system.

### 4.11.3 N<sub>2</sub>O Cylinder High Pressure Leak Test

1. Set the system switch to the **OFF** position and disconnect the N<sub>2</sub>O pipeline supply.
2. Set the N<sub>2</sub>O flow to zero.
3. Open the N<sub>2</sub>O cylinder valve.
4. Record the current cylinder pressure.
5. Close the N<sub>2</sub>O cylinder valve.
6. Record the cylinder pressure after one minute.  
If the cylinder pressure decreases more than 0.5 MPa (73 psi), install a new cylinder gasket. Repeat steps 1 through 6. If the leak continues, do not use the cylinder supply system.

### 4.11.4 Air Cylinder High Pressure Leak Test

1. Set the system switch to the **OFF** position and disconnect the Air pipeline supply.
2. Set the Air flow to zero.
3. Open the Air cylinder valve.
4. Record the current cylinder pressure.
5. Close the Air cylinder valve.
6. Record the cylinder pressure after one minute.  
If the cylinder pressure decreases more than 1.25 MPa (181 psi), install a new cylinder gasket. Repeat steps 1 through 6. If the leak continues, do not use the cylinder supply system.

## 4.12 Flow Control System Test

- WARNING:** If N<sub>2</sub>O is available and flows through the system during this test, use a safe and approved procedure to collect and remove N<sub>2</sub>O gas.
- WARNING:** Incorrect gas mixtures can cause patient injury. If the O<sub>2</sub>:N<sub>2</sub>O ratio system does not supply O<sub>2</sub> and N<sub>2</sub>O in the correct proportions, do not use the system.
- CAUTION:** Slowly open the cylinder valves to avoid damage. Do not use excessive force on the flow controls. After performing the cylinder tests, close all cylinder valves if cylinder supplies are not used.
- CAUTION:** When the electronic mixer is disabled, the backup flow control valve can work. The initial flow is 1 L/min of O<sub>2</sub>. The backup flow display only has a total flowmeter which range is up to 10 L/min.
- CAUTION:** Turn the backup flow controls slowly. To avoid damaging the control valves, do not turn further when the flowmeter reading is outside the range. When turning a flow control knob clockwise to decrease flow, the flowmeter should reach 1 L/min before the knob reaches its most clockwise mechanical stop (off) position. Do not turn any further when the knob has reached the off position. Turning a flow control knob counterclockwise increases flow.

The flow control system includes Electronic Flow Control System (hereinafter referred to as EFCS) and Backup Flow Control System (hereinafter referred to as BFCS). Normally, EFCS is used. Perform EFCS and BFCS tests before any case:

1. Connect the pipeline supplies or slowly open the cylinder valves.
2. Set the system switch to the **ON** position.
3. Select **Setup** softkey > **General** tab and set the **Fresh Gas Control** to **Direct Flow**.
4. Set the **Balance Gas** to **Air**.
5. Adjust the Air flow. Ensure that the displayed reading of electronic flowmeter is consistent with the setting.
6. Set the **Balance Gas** to **N<sub>2</sub>O**.
7. Adjust the N<sub>2</sub>O flow gradually. Ensure that the O<sub>2</sub> flow increases with the increase of N<sub>2</sub>O flow and that the O<sub>2</sub> and N<sub>2</sub>O flows are in the proportion of 1 to 3.
8. Set both O<sub>2</sub> flow and N<sub>2</sub>O flow to 5 L/min.
9. Turn off the O<sub>2</sub> pipeline supply.
10. Push the O<sub>2</sub> flush button to release the pressure inside the machine.
11. Check that the technical alarm **O<sub>2</sub> Supply Failure** appears, N<sub>2</sub>O flow is zero, and O<sub>2</sub> flow stays at 5 L/min.
12. Check that N<sub>2</sub>O flow is available and is finally stabilized at 5 L/min after the O<sub>2</sub> pipeline supply is turned on.
13. Push the BFCS button and check that the BFCS is deployed normally. Check that the BFCS is automatically deployed in position and the prompt message **Backup Flow Control is enabled** displays.
14. After checking that the BFCS is deployed, visually check the total flowmeter for basal flow of approximately 1 L/min.
15. Adjust the Air needle valve. Increase Air flow gradually and check that the total flow continues to rise to more than 10 L/min. Close the Air needle valve.

16. Adjust the O<sub>2</sub> needle valve. Increase O<sub>2</sub> flow gradually and check that the total flow continues to rise to more than 10 L/min.
17. Turn the O<sub>2</sub> needle valve for half a turn.
18. Select **Disable Backup Flow Control** and check that the prompt message **Close manual valves prior to disabling Backup Flow Control** displays.
19. Close the O<sub>2</sub> needle valve. Check that the prompt message **Close manual valves prior to disabling Backup Flow Control** disappears.
20. Select **Disable Backup Flow Control** and check that the BFCS is retracted normally.
21. Push the BFCS button and make sure that the BFCS is deployed normally.
22. Turn the Air needle valve for half a circle.
23. Select **Disable Backup Flow Control** and make sure that the prompt message **Close manual valves prior to disabling Backup Flow Control** appears.
24. Close the Air needle valve. Make sure that the prompt message **Close manual valves prior to disabling Backup Flow Control** disappears.
25. Select **Disable Backup Flow Control** and check that the BFCS is retracted normally.

**NOTE:** If the needle valve for BFCS is not fully closed when selecting **Disable Backup Flow Control**, the message **Close manual valves prior to disabling Backup Flow Control** displays. In this case, check if all the needle valves are fully closed. When the needle valves are fully closed, select "Disable Backup Flow Control" to undeploy the BFCS.

**NOTE:** When viewing the readings on the total flowmeter, keep your visual angle at the same level of the float. The scale reading may vary when viewed at a different angle.

## 4.13 Vaporizer Tests

**WARNING:** During the vaporizer tests, the anesthetic agent exits from the fresh gas outlet. Use a safe and approved procedure to remove and collect the agent.

**WARNING:** To prevent damage, turn the flow controls fully clockwise (flow OFF) before using the system.

Before the test, ensure that the vaporizers are correctly installed. For details about vaporizer installation, see "Install the Vaporizer" on page 2-5.

### 4.13.1 Vaporizer Back Pressure Test

1. Connect the O<sub>2</sub> pipeline supply or open the O<sub>2</sub> cylinder valve.
2. Set the O<sub>2</sub> flow to 6 L/min.
3. Ensure that the O<sub>2</sub> flow stays constant.
4. Adjust the vaporizer concentration from 0 to 1%. Ensure that the O<sub>2</sub> flow must not decrease more than 1 L/min through the full range. Otherwise, install a different vaporizer and repeat this step. If the problem persists, the malfunction is in the anesthesia system. Do not use this system.
5. Test each vaporizer as per the steps above.

**NOTE:** Do not perform this test on the vaporizer when the concentration control is between "OFF" and the first graduation above "0" (zero) as the amount of anesthetic drug outputted is very small within this range.

### 4.13.2 Manual Leak Test

1. Set the **Auto/Manual** ventilation switch to **Manual**.
2. Connect a breathing circuit to the inspiratory and expiratory ports. Connect a ventilation bag to the bag arm.
3. Set APL Valve to 75 cmH<sub>2</sub>O.
4. Close the breathing system at the patient connection by connecting the Y-piece on the breathing circuit to the leak test port.
5. Inflate the ventilation bag with O<sub>2</sub> flush to 40 cmH<sub>2</sub>O.
6. Verify that circuit holds pressure for greater than 10 seconds.
7. Set the APL valve to SP.

### 4.13.3 Vaporizer Leak Test

1. Set the **Auto/Manual** ventilation switch to **Manual**.
2. Set the APL valve to the **SP** position.
3. Connect one end of the breathing circuit to the bag arm, one end to the inspiratory port and the Y-piece to the test port:



4. Mount and lock the vaporizer onto the vaporizer mount. (Certain vaporizers need to be set to at least 1% for correct testing. See the vaporizer manufacturer's manual for details.)
5. Set the fresh gas flow to 0.2 L/min.
6. Set the APL valve to 75 and verify that the pressure on the airway pressure gauge increases above 30 cmH<sub>2</sub>O within 2 minutes.
7. Turn off the vaporizer.
8. Repeat steps 4, 5, 6, and 7 for the other vaporizer.



## 4.14 Breathing System Tests

**WARNING:** Objects in the breathing system can stop gas flow to the patient. This can cause injury or death. Ensure that there are no test plugs or other objects in the breathing system.

**WARNING:** Do not use a test plug that is small enough to fall into the breathing system.

1. Ensure that the breathing system is correctly connected and not damaged.
2. Ensure that the check valves in the breathing system work correctly:
  - a. The inspiratory check valve opens during inspiration and closes at the start of expiration.
  - b. The expiratory check valve opens during expiration and closes at the start of inspiration.

### 4.14.1 Bellows Test

1. Select the **End Case** button in the **Manual** tab.
2. Follow the screen prompts to end the case and enter **Standby** mode.
3. Set the **Auto/Manual** ventilation switch to **Auto**.
4. Set all flow to zero.
5. Close the breathing system at the patient connection by connecting the Y-piece on the breathing circuit to the leak test port.
6. Push the O<sub>2</sub> flush button to expand the bellows to the top of the bellows enclosure.
7. Ensure that the pressure does not increase to more than 15 cmH<sub>2</sub>O on the airway pressure gauge.
8. The bellows should not fall faster than a rate of approximately 300 ml/min. If the leak rate is greater, troubleshoot the source of the leak. If the source of the leak is the bellows, then replace the bellows.

### 4.14.2 Breathing System Leak Test in Manual Ventilation Status

1. Set the **Auto/Manual** ventilation switch to **Manual**.
2. Adjust all flowmeters to zero.
3. Select the **End Case** button in the **Manual** tab.
4. Follow the screen prompts to end the case and enter **Standby** mode.
5. Connect the manual bag to the manual bag port.
6. Adjust the APL to 50 cmH<sub>2</sub>O position.
7. Connect the Y-piece on the breathing circuit to the leak test port.
8. Push the O<sub>2</sub> flush button until the airway pressure gauge value is between 25 and 35 cmH<sub>2</sub>O.
9. Release the O<sub>2</sub> flush button. A pressure decrease on the airway pressure gauge indicates a leak. Contact your service personnel.

### 4.14.3 APL Valve Test

- 1.** Select the **End Case** button in the **Manual** tab.
- 2.** Follow the screen prompts to end the case and enter **Standby** mode.
- 3.** Set the Auto/Manual switch to Manual.
- 4.** Connect the manual bag to the manual bag port.
- 5.** Connect the Y-piece on the breathing circuit to the leak test port.
- 6.** Turn the APL valve control to 30 cmH<sub>2</sub>O.
- 7.** Set the O<sub>2</sub> flow to 10 L/min. Turn any other gases off.
- 8.** Press the flush button until the manual bag is inflated and then release the button. Ensure that the reading on the airway pressure gauge is with the range of 25 cmH<sub>2</sub>O to 40 cmH<sub>2</sub>O after it is steady.
- 9.** Turn the APL valve control to the fully open position.
- 10.** Set the O<sub>2</sub> flow to 3 L/min. Turn any other gases off.
- 11.** Ensure that the reading on the airway pressure gauge is less than 5 cmH<sub>2</sub>O.
- 12.** Push the O<sub>2</sub> flush button continuously. Ensure that the reading on the airway pressure gauge does not exceed 10 cmH<sub>2</sub>O.
- 13.** Turn the O<sub>2</sub> flow to zero. Ensure that the reading on the airway pressure gauge does not decrease below 0 cmH<sub>2</sub>O.

## 4.15 Alarm Tests

Test alarms by creating an alarm condition on the A7 and verifying the corresponding alarm indicators are present on the monitor.

### 4.15.1 Prepare for Alarm Tests

1. Connect a test lung or manual bag to the Y-piece of the breathing circuit.
2. Set the Auto/Manual switch to Auto.
3. Set the system switch to the **ON** position.
4. Set the system to the **Standby** mode.
5. Set the Patient Size to Adult.
6. Set the ventilator controls as follows:
  - Ventilation mode: select VCV
  - Vt: 500 ml
  - Rate: 12 bpm
  - I:E: 1:2
  - Tpause: 10%
  - PEEP: OFF
  - Plimit: 30 cmH<sub>2</sub>O
7. Set the Auto/Manual switch to Manual.
8. Set the O<sub>2</sub> flow to 0.5 to 1 L/min.
9. Set the Auto/Manual switch to Auto.
10. Push the O<sub>2</sub> flush button to expand the bellows to the top of the bellow enclosure.
11. Ensure that:
  - The main screen displays the correctly set data. The measured values should be within the tolerances specified in the specifications (see TABLE 9-31, "Control and Monitoring Accuracy," on page 9-19).
  - The bellows inflates and deflates normally during mechanical ventilation.

## 4.15.2 Test the O<sub>2</sub> Concentration Monitoring and Alarms

**NOTE:** For A7s with an installed gas module, disconnect the sample tube from the Y-piece and breathe into it until you see a CO<sub>2</sub> reading on the screen. Then reconnect the sample tube to the Y-piece. This will activate the gas module alarms.

1. Set the Auto/Manual switch to Manual and exit the **Standby** mode.
2. Make sure that the external AG module is installed and its warm-up is completed. Let the sampling port on the AG module watertrap open to the air directly. Ensure that the sensor measures approximately 21 % O<sub>2</sub> in room air by verifying the FiO<sub>2</sub> value on the main screen.
3. Select the **Alarms** softkey and then the **Limits** tab. Set the FiO<sub>2</sub> low alarm limit to 50 %.
4. Ensure that a **FiO<sub>2</sub> Too Low** alarm occurs.
5. Set the FiO<sub>2</sub> low alarm limit back to a value less than the measured O<sub>2</sub> value and check that the alarm cancels.
6. Connect the sampling port on the AG module watertrap to the breathing system.
7. Select the **Alarms** softkey and then the **Limits** tab. Set the FiO<sub>2</sub> high alarm limit to 50 %.
8. Connect the manual bag to the manual bag port. Push the O<sub>2</sub> flush button to fill the manual bag. Ensure that the sensor measures at least 90 % O<sub>2</sub>.
9. Ensure that a **FiO<sub>2</sub> Too High** alarm occurs.
10. Set the FiO<sub>2</sub> high alarm limit to 100 % and check that the alarm cancels.

## 4.15.3 Test the Low Minute Volume (MV) Alarm

1. Set the **Auto/Manual** ventilation switch to **Auto**.
2. Set the ventilator controls as follows:
  - Ventilation mode: select VCV
  - Vt: 500 ml
  - Rate: 12 bpm
  - I:E: 1:2
  - Tpause: 10%
  - PEEP: OFF
  - Plimit: 30 cmH<sub>2</sub>O
3. Select the **Alarms** softkey and then the **Limits** tab. Set the MV low alarm limit to 8.0 L/min.
4. Ensure that a low MV alarm occurs after approximately 60 seconds.
5. Select the **Alarms** softkey and then the **Limits** tab. Set the MV low alarm limit back to a value less than the measured MV value and check that the alarm cancels.

## 4.15.4 Test the Apnea Alarm

1. Connect the manual bag to the manual bag port
2. Set the **Auto/Manual** ventilation switch to **Manual**.
3. Turn the APL valve control to set the APL valve to 10 cmH<sub>2</sub>O.
4. Inflate using the O<sub>2</sub> flush button and squeeze the manual bag to check that a complete breathing cycle occurs on screen.

5. Stop inflating the manual bag and wait for more than 30 seconds to check that the **Apnea** alarm occurs.
6. Inflate and squeeze the manual bag to ensure that the **Apnea** alarm cancels.

#### 4.15.5 Test the Continuous Airway Pressure Alarm

1. Connect the manual bag to the manual bag port.
2. Set the O<sub>2</sub> flow to zero.
3. Turn the APL valve control to set the APL valve to 30 cmH<sub>2</sub>O position.
4. Set the **Auto/Manual** ventilation switch to **Manual**.
5. Connect the Y piece on the breathing circuit to the leak test port to occlude the patient end of the breathing system.
6. Push the O<sub>2</sub> flush button for approximately 15 seconds. Ensure that the Continuous Airway Pressure alarm occurs.
7. Disconnect the breathing circuit and check that the alarm cancels.
8. Reconnect the breathing circuit.

#### 4.15.6 Test the High Paw Alarm

1. Set the **Auto/Manual** ventilation switch to **Auto**.
2. Select the **Alarms** softkey and then the **Limits** tab.
3. Set the PEAK low alarm limit to 0 cmH<sub>2</sub>O and PEAK high alarm limit to 10 cmH<sub>2</sub>O.
4. Ensure that a **Paw Too High** alarm occurs.
5. Set the PEAK high alarm limit to 40 cmH<sub>2</sub>O.
6. Ensure that the alarm cancels.

#### 4.15.7 Test the Low Paw Alarm

1. Set the **Auto/Manual** ventilation switch to **Auto**.
2. Select the **Alarms** softkey and then **Limits** tab.
3. Set the Peak low alarm limit to 20 cmH<sub>2</sub>O.
4. Disconnect the test lung or manual bag from the Y-piece of the breathing circuit.
5. Wait for 20 seconds. View the alarm area and ensure that a **Paw Too Low** alarm occurs.
6. Connect the test lung or manual bag to the Y-piece of the breathing circuit. If using a manual bag, squeeze the bag to cancel the alarm.
7. Ensure that the alarm cancels.

### 4.16 Preoperative Preparations

1. Ensure that the ventilator parameters and alarm limits are set to applicable clinical levels.
2. Ensure that the system is in the **Standby** mode.
3. Ensure that the equipment for airway maintenance, manual ventilation and tracheal intubation, and applicable anesthetic and emergency drugs are available.
4. Set the **Auto/Manual** ventilation switch to **Manual**.
5. Connect the manual bag to the manual bag port.
6. Turn off all vaporizers.

7. Turn the APL valve control to the SP position to fully open the APL valve.
8. Set all gas flows to zero.
9. Ensure that the breathing system is correctly connected and not damaged.

**WARNING:** Before connecting a patient, flush the A7 anesthesia machine with 8 L/min of O<sub>2</sub> for at least two minutes. This removes unwanted mixtures and by-products from the system.

## 4.17 Inspect the Active AGSS

1. Connect the vacuum hose to the EVAC port or vacuum port of the healthcare facility and turn on the waste gas disposal system. Adjust the position of the float to be between the **MIN** and **MAX** lines by turning its flow adjustment knob (counterclockwise increases flow, clockwise decreases flow).
2. Ensure that the float rises and exceeds the **MIN** mark. If any blockage, tackiness, or damage occurs to the float, disassemble, clean the filter, and assemble the float again or replace the float.
3. Drain any moisture from the waste gas hose. Reconnect the waste gas hose to the active AGSS waste gas port.

**NOTE:** Do not block the active AGSS pressure compensation openings during the inspection. If the float cannot rise, the possible reasons are:

1. The float surface is tacky. Turn over the active AGSS and check if the float moves up and down freely.
2. The float is rising slowly. The filter may be blocked. Check if the filter is blocked.
3. The waste gas disposal system is not working or the pump rate is less than the minimum flow value of the active AGSS specification. Check the waste gas disposal system.

**CAUTION:** Keep the inlet port cover of AGSS three ways connector assembly closed when the ACGO circuit is not used.

## 4.18 Inspect the Negative Pressure Suction Device

1. Assemble the negative pressure suction device.
2. Occlude the suction tube inlet at the patient end.
3. Turn on the negative pressure pipeline supply.
4. Set the selector switch to REG.
5. Turn the negative pressure adjustment knob to the maximum position and verify if the reading on the pressure gauge increases gradually.

# **Operations**

---

Powering On the A7 Anesthesia System.....	5-2
Powering Off the A7 Anesthesia System .....	5-2
Patient Setup .....	5-3
Input Fresh Gas .....	5-5
Input Fresh Gas .....	5-5
Ventilation Modes .....	5-7
Start Mechanical Ventilation.....	5-18
Stop Mechanical Ventilation.....	5-18
Relationships of Ventilation Parameters .....	5-18
Parameter Monitoring (Numerics) .....	5-18

**WARNING:** Before using the A7 Anesthesia System on the patient, ensure that the system is correctly assembled and in good condition, and that all the tests described in the Preoperative Tests are already completed. In case of test failure, do not use the system. Have a qualified Mindray service representative repair the system.

## 5.1 Powering On the A7 Anesthesia System

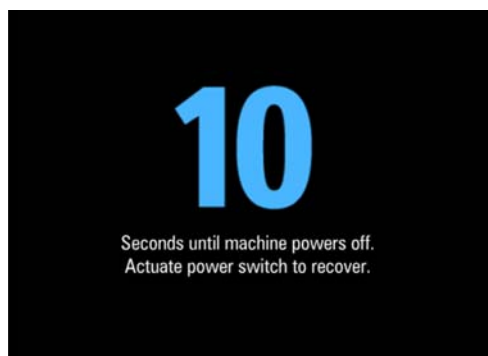
1. Connect the gas supplies and gas cylinders to the A7.
2. Connect the power cord to the AC power source. Check that the AC power LED illuminates.
3. Set the system switch to **ON**. Check that both the operating state LED and battery LED are illuminated (the battery is being charged or fully charged).
4. The display shows the start-up screen.
5. The alarm LED flashes red, yellow, and cyan once in turn and then a beep sounds. This verifies that audible and visual alarms are operational.
6. After several seconds, the system self-test screen displays and the A7 System self-test runs.

## 5.2 Powering Off the A7 Anesthesia System

The A7 System provides a powering off function with the following features:

- A prompt tone is heard when the user turns off the A7. If the system switch is turned off in Standby mode, the A7 will immediately power off.
- If the system switch is turned off in Manual mode or in any of the Automatic ventilation modes, the A7 waits 12 seconds to power off completely. In the 12-second power off delay period, the screen displays a 10 second countdown timer. If the A7 is performing Automatic ventilation, the ventilator continues ventilating the patient in the current ventilation mode.
- A beep sounds for each second of the countdown from 10 to 1 second, after which a two-second shutdown tone is heard when the timer reaches zero.
- The volume of power off delay sound can be adjusted in the System Alerts setting in the Alarm Volume menu.
- When the user turns on the machine during the power off delay period, the countdown timer disappears, and the ventilator resumes its previous state.

**NOTE:** The powering off delay function is not implemented when in the Standby mode, only when actively ventilating.



**FIGURE 5-1** Countdown timer screen



## 5.3 Patient Setup

### 5.3.1 End Case / Standby Mode

The **End Case** button is located in the **Manual** tab (see FIGURE 5-2). The **End Case** button is only available when the **Auto/Manual** ventilation switch is set to **Manual**.



**FIGURE 5-2** End Case Button

After selecting the **End Case** button, a warning box with a **Restore default settings** checkbox will be displayed. Selecting the **Restore default settings** checkbox reloads the user defaults, clears the patient demographics, the history, the spirometry reference loops, and places the system into the **Standby** mode (see FIGURE 5-4).

If the **Restore default settings** checkbox is not selected, all the settings are retained.



**FIGURE 5-3** End Case Checkbox

In the **Standby** mode, all system functions are not working. It is the default system startup mode and is used after ending the case.



**FIGURE 5-4** Standby Mode

**To end the case and enter the Standby mode:**

1. Set the **Auto/Manual** ventilation switch to **Manual**.

**NOTE:** The A7 System will not allow the End Case button to be selected until the Auto/Manual ventilation switch is set to Manual.

2. Select the **End Case** button in the **Manual** tab (see FIGURE 5-2).
3. Follow the screen prompts to end the case and enter **Standby** mode.

**NOTE:** After selecting End Case, you can set whether to restore default settings from the pop-up dialog box.

**To exit Standby:**

To exit the **Standby** mode, set the **Auto/Manual** ventilation switch to **Manual**, then touch the screen.

**NOTE:** The End Case button is only available when the system is not in Standby, and the Auto/Manual switch is in the Manual position.

**NOTE:** When the system is in the Standby mode, the Bypass, ACGO, Monitor and End Case buttons in the Manual tab are disabled. However, the Alarms button remains enabled and can be toggled to On or Off.

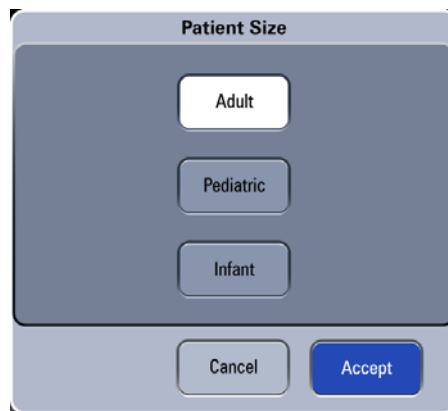
**WARNING:** Selecting End Case to enter the Standby mode will stop ventilation and parameter monitoring. Do not select Standby mode if the patient requires continuous ventilation.

### 5.3.2 Select the Patient Size (Adult, Pediatric, Infant)

Patient size can only be changed when the current ventilation mode is **Manual** mode, **Standby** mode or **Monitor** mode.

1. Select **Manual** mode or select the **End Case** button (in the **Manual** tab) to enter **Standby** mode.
2. Select the **Patient Size** softkey at the top left of the main screen. The softkey displays **Adult**, **Pediatric**, or **Infant**.
3. Select the **Patient Size: Adult**, **Pediatric**, or **Infant**.
4. Select the **Accept** softkey to confirm the change, or select the **Cancel** softkey to disregard the change.

**NOTE:** The A7 saves the latest patient parameter settings (VCV, PCV, PCV-VG, PS, SIMV-VC, SIMV-PC, and Alarms) for each patient type: **Adult**, **Pediatric**, and **Infant**. Changing to another patient type does not erase the parameter settings from the previous patient type. For example, changing from **Adult** to **Pediatric** and back to **Adult** results in the **Adult** patient parameter settings still being saved.



**FIGURE 5-5** Patient Size Setup Menu

## 5.4 Input Fresh Gas

### 5.4.1 Set O<sub>2</sub>, N<sub>2</sub>O and Air Inputs

Set the O<sub>2</sub> and balance gas through EFCS or set the O<sub>2</sub> and Air flow through BFCS.

Safety systems within the A7 work to prevent hypoxic mixtures from being delivered to the patient. Nitrous oxide will not be delivered unless oxygen flow is present.

All A7 units are designed to maintain a safe O<sub>2</sub> : N<sub>2</sub>O ratio by allowing nitrous oxide to be set to a flow rate that is proportional to a previously adjusted flow of oxygen. The N<sub>2</sub>O flow is limited by the flow of O<sub>2</sub> so that a safe ratio of no less than 21% oxygen can be maintained.

**WARNING:** When BFCS is in use, ensure that both O<sub>2</sub> and air flow controllers are turned OFF fully at the start and at the end of each case.

**NOTE:** The total flowmeter is calibrated based on 100% O<sub>2</sub>. The accuracy of the flowmeter may degrade with other gas or mixed gas.

- NOTE:** When viewing the readings on the total flowmeter, keep your visual angle at the same level of the float. The scale reading may vary when viewed at a different angle.
- NOTE:** If the readings shown on the electronic flowmeters differ from that on the total flowmeter, the electronic flowmeter prevails and the total flowmeter is an approximate value.
- NOTE:** When the AC power supply is not connected and batteries are depleted, the flow and the composition of the fresh gas are not affected. When the individual N<sub>2</sub>O or Air supply fails, the corresponding fresh gas cannot be achieved. When O<sub>2</sub> supply fails, both O<sub>2</sub> and N<sub>2</sub>O fresh gas cannot be achieved.

## 5.4.2 Set Anesthetic Agent

- NOTE:** You do not need to perform this operation if inspiratory anesthetic agent is not used.
- NOTE:** The A7 anesthesia system can be mounted with vaporizers corresponding with Halothane, Enflurane, Isoflurane, Sevoflurane and Desflurane. Only one vaporizer can be opened at a time because of the interlock system.

### 5.4.2.1 Select the Desired Anesthetic Agent

1. Determine the anesthetic agent to be used and then fill the vaporizer.

**NOTE:** Install the vaporizers with a Selectatec interlock system that are compliant to ISO 80601-2-13 on the A7 unit. Refer to the vaporizer manufacturer's Instructions For Use for filling or draining the vaporizer and other information.

**WARNING:** Ensure that the correct anesthetic agent is used. The vaporizer is designed with the specific anesthetic agent named on it and further indicated by color coded labelling. The concentration of the anesthetic agent actually output varies if the vaporizer is filled with the wrong agent.
2. Mount the vaporizer filled with anesthetic agent onto the A7 Anesthesia System. See "Install the Vaporizer" on page 2-5.

### 5.4.2.2 Adjust the Concentration of Anesthetic Agent

Push and turn the concentration control on the vaporizer to set the appropriate concentration of anesthetic agent. For details about how to use the anesthetic agent, refer to the Vaporizer Instructions for Use.

## 5.5 Ventilation Modes

**NOTE:** In all ventilation modes, when inspiration pressure reaches the high alarm limit of Paw, the system switches to expiration immediately and airway pressure is released.

**NOTE:** When the drive gas supply fails, mechanical ventilation cannot work normally.

### 5.5.1 Monitored Parameters

**NOTE:** The monitored parameters are measured in the condition of ATPS (ambient temperature and pressure saturated).

The A7 monitors the following ventilation parameters:

PARAMETER	RANGE*	COMMENTS
PEAK	-20 – 120 cmH <sub>2</sub> O	
MEAN	-20 – 120 cmH <sub>2</sub> O	
Vt	0 – 3000 ml	
MV	0 – 100 L	
PLAT	-20 – 120 cmH <sub>2</sub> O	
Rate	0 – 120 bpm	
PEEP	0 – 70 cmH <sub>2</sub> O	
I:E	—	Displayed only in SIMV-VC, SIMV-PC, and PS modes

\* If the monitored parameter is out of range, it displays as “---”.

### 5.5.2 Ventilation Modes

The A7 provides the following ventilation modes:

VENTILATION MODE	PARAMETERS
VCV	Vt, Rate, I:E, Tpause, PEEP, Plimit
SIMV-VC	Vt, Rate, Tinsp, Tpause, PEEP, Plimit, PS (On/Off), ΔP, Trigger, Tslope
PCV	VtG, PlimVG, Pinsp, Rate, I:E, PEEP, Tslope
SIMV-PC	Pinsp, Rate, Tinsp, PS (On/Off), ΔP, Trigger, PEEP, Tslope
PS	Min Rate, ΔP, Trigger, PEEP, Tslope, Apnea Ti
Manual	Bypass, Alarms, ACGO, Monitor
ACGO	N/A *
Monitor	N/A *

\*N/A - Not Applicable.

### 5.5.3 Change Ventilation Mode

#### To change ventilation mode to Manual

1. Use the Auto/Manual ventilation switch on the breathing system block to enter and exit Manual ventilation mode.

**To change ventilation mode to VCV, SIMV-VC, PCV, SIMV-PC, or PS:**

1. Select the tab of the desired ventilation mode. The **Set Mode** button (or **Preset Mode** button in **Manual** mode) flashes. (see FIGURE 5-6)
2. Select the **Set Mode** button (or **Preset Mode** button in **Manual** mode) to confirm. If the **Set Mode** button is not selected after several seconds, an audio reminder sounds for several seconds and then the system returns to the previous ventilation mode.
3. Optionally, select each available ventilation parameter to edit the parameter setting.
4. Move the **Auto/Manual** ventilation switch to the **Auto**.

**NOTE:** When the **Auto/Manual** switch is in **Auto** position, all the buttons in **Manual** tab (**Alarms**, **Bypass**, **ACGO**, **Monitor** and **End Case**) are disabled; **Alarms** are set to **On**; and **Bypass** is set to **Off**.



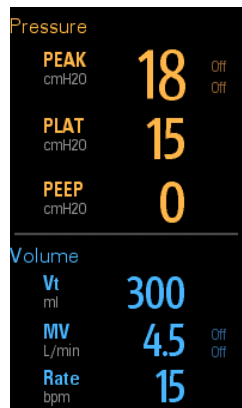
**FIGURE 5-6** Ventilation Mode Tabs

## 5.5.4 Set Manual Ventilation Mode

**Manual** ventilation mode is the operating mode used for manually ventilating a patient or to let a patient breathe spontaneously. To use the manual mode, the user must first set the APL valve to the desired pressure value and then use the **Auto/Manual** ventilation switch on the breathing module to enter and exit **Manual** mode. Push the **O<sub>2</sub>** flush button to inflate the bag if necessary.

When the **Auto/Manual** switch is set to **Manual**, and the **Alarms** button in the **Manual** mode tab is set to **Off**, the alarm limit indicators on the main screen to the right of the measured values related to **Pressure** and **Volume** (such as **PEAK** and **MV**) will change to **Off** (see FIGURE 5-7).

The **Alarms** button setting (**On/Off**) in the **Manual** mode tab is saved and restored when toggling from **Manual** to **Auto** and back to **Manual** mode. For example, if the **Alarms** button is set to **Off**, this setting will be saved and restored to **Off** after switching to **Auto** and back to **Manual** mode.



**FIGURE 5-7** Alarm Limit Indicators

## Setting the APL Valve for Manual Ventilation

Rotate the APL valve adjustment knob to the desired pressure. The number on the rotating portion that lines up with the index mark on the bottom section of the valve indicates the approximate pressure setting.

**NOTE:** Clockwise rotation increases the pressure, and counterclockwise rotation decreases the pressure.

The patient can be ventilated by hand using the breathing bag. The pressure will be limited to the value set on the APL valve.

## Setting the APL Valve for Spontaneous Breathing

Rotate the APL valve adjustment knob fully counterclockwise until the **SP** marking on the knob lines up with the index mark on the bottom section of the valve. The valve will then be open for spontaneous patient breathing.

**NOTE:** In the manual ventilation mode, you can use the APL valve to adjust the breathing system pressure limit and gas volume in the manual bag. When the pressure in the breathing system reaches the pressure limit set for the APL valve, the valve opens to release excess gas.

**NOTE:** The APL valve adjusts the breathing system pressure limit during manual ventilation. Its scale shows approximate pressure.

## Cardiac Bypass Mode

**Cardiac Bypass** mode is only available in **Manual** ventilation mode. This mode turns off pressure volume and apnea alarms when they are not appropriate (e.g., during heart/lung bypass).

**NOTE:** When Bypass mode is On, the Alarms button is disabled and set to Off.

A confirmation dialogue displays when turning Bypass mode On or Off.

Enter **Cardiac Bypass** mode by setting the **Bypass** softkey in **Manual** mode to **On**. When the **Bypass** softkey is set to **On**, the **Alarm** softkey is disabled and set to **Off** automatically. When **Bypass** is set to **Off**, the **Alarm** button returns to its setting before entering **Bypass**. When exiting Manual mode or discharging a patient, Bypass will be set to Off.

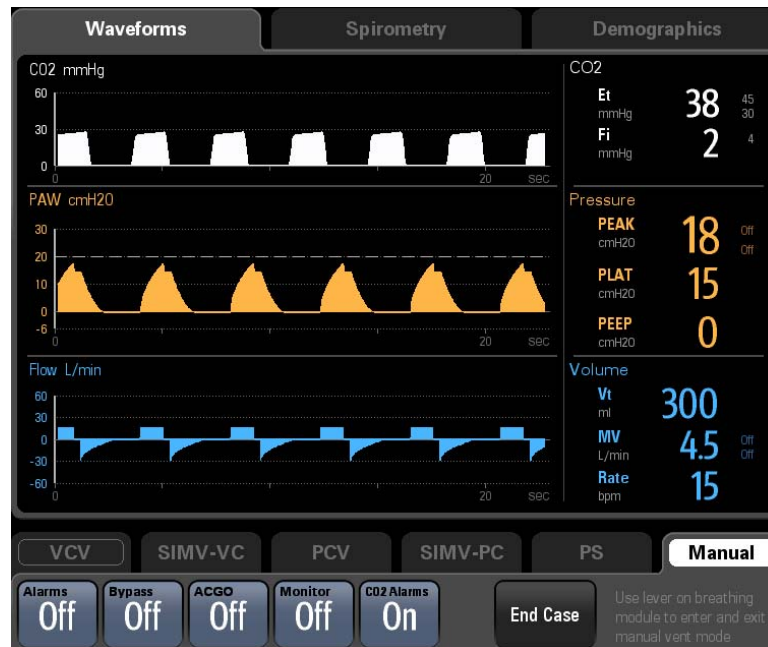


**FIGURE 5-8** Bypass Mode Softkey

## Setting Alarms

In **Manual** ventilation mode, when **Bypass** and **Monitor** are set to **Off**, the pressure, volume and apnea alarms can be turned off by setting the **Alarms** softkey to **Off**. The related alarm limits are then displayed as **Off**.

Pressure, volume and apnea alarms can be turned on by setting the **Alarms** softkey to **On**, which returns the related alarm limits to their original settings.



**FIGURE 5-9** Set Alarms to Off

## 5.5.5 Make Settings before Starting Mechanical Ventilation Mode

1. Set the **Auto/Manual** ventilation switch to **Manual**. If discharging a patient, select the **End Case** button in the **Manual** tab to enter **Standby** mode.
2. Select the desired ventilation mode tab.
3. Set the desired ventilation parameters.
4. Select the **Preset** button (flashing green) on the right of the ventilation tabs to confirm the ventilation mode.
5. If necessary, push the O<sub>2</sub> flush button to inflate the bellows.
6. If in **Standby**, exit **Standby** by touching the main screen.
7. To begin mechanical ventilation, set the **Auto/Manual** ventilation switch to **Auto**.

## 5.5.6 Volume Control Ventilation (VCV)

Volume Control Ventilation (VCV) mode is a fully-mechanical ventilation mode. In the VCV mode, each time mechanical ventilation starts, gas is delivered to the patient at a constant flow, which reaches the preset Vt within the gas delivery time. To ensure a certain amount of Vt, the resulted airway pressure (Paw) changes based on patient pulmonary compliance and airway resistance.

In VCV mode, set Plimit to prevent high airway pressure from injuring the patient. In this mode, set Tpause to improve patient pulmonary gas distribution and PEEP to improve expiration of end-tidal carbon dioxide and to increase oxygenation of breathing process.

To ensure the set tidal volume gas delivery, the ventilator adjusts gas flow based on the measured inspiratory volume, dynamically compensates for the loss of tidal volume arising from breathing system compliance and system leakage and eliminates the effect of fresh gas as well. This is called tidal volume compensation.



In the VCV mode, if tidal volume compensation has failed, the A7 Anesthesia System can continue delivering gas stably but cannot compensate for the effects of fresh gas flow and breathing system compliance losses.



In VCV and SIMV-VC modes, when inspiration pressure reaches Plimit, respectively, the inspiration pressure is held.



**FIGURE 5-10** Volume Control Ventilation (VCV) Tab

### 5.5.6.1 To Set VCV Mode

1. Select the **VCV** tab on the main screen.
2. Check that all VCV parameters are set appropriately. If necessary, select the parameter softkey to edit the parameters settings (see FIGURE 5-10). You can use the digital keyboard on the screen to enter the desired value, or continuously

press the  or  buttons to rapidly increase or decrease the parameter values.

3. Select the **Set Mode** softkey to confirm.

#### VCV parameters:

- Vt: Tidal volume
- Rate: Breath rate
- I:E: Ratio of inspiratory time to expiratory time

**NOTE:** The screen displays the calculated  $T_{insp}$  when adjusting the I:E ratio.

- Tpause: Percentage of inspiratory plateau time in inspiratory time
- PEEP: Positive end-expiratory pressure
- Plimit: Pressure limit level

**NOTE:** Before activating a new mechanical ventilation mode, ensure that all related parameters are set appropriately.

### 5.5.7 Pressure Control Ventilation (PCV)

Pressure control ventilation (PCV) mode is a basic fully-mechanical ventilation mode. In the PCV mode, each time mechanical ventilation starts, PAW rises rapidly to the preset  $P_{insp}$ . Then gas flow slows down through the feedback system to keep PAW constant until expiration starts at the end of inspiration. The tidal volume delivered in the PCV mode changes based on patient pulmonary compliance and airway resistance.

In the PCV mode, you can set PEEP to improve expiration of end-tidal carbon dioxide and to increase oxygenation of breathing process.

For the A7, in PCV mode, Tidal Volume Guarantee (VtG) can be enabled with the VtG setting. When VtG is a value, then P<sub>insp</sub> is disabled. The ventilator attempts to deliver the set VtG while maintaining the PAW at or below PlimVG. When VtG is Off, PlimVG is disabled and P<sub>insp</sub> is enabled. Changing the value of P<sub>insp</sub> will automatically set PlimVG to the same value, but PlimVG can be adjusted without affecting the value of P<sub>insp</sub>.



**NOTE:** In PCV mode, even when the PlimVG or P<sub>insp</sub> parameters are inactive, they are restricted to the parameter relationship equations  $PlimVG \geq PEEP + 5$  and  $P_{insp} \geq PEEP + 5$ . See section C.10 (page C-13) "Ventilation Parameter Relationships".



**FIGURE 5-11** Pressure Control Ventilation Tab

### 5.5.7.1 To Set PCV Mode

1. Select the **PCV** tab on the main screen.
2. Check that all PCV parameters are set appropriately. If necessary, select the parameter softkey to edit the parameters settings (see FIGURE 5-11). You can use the digital keyboard on the screen to enter the desired value, or continuously

press the  or  buttons to rapidly increase or decrease the parameter values.

3. Select the **Set Mode** softkey to confirm.

#### PCV parameters:

- VtG : Tidal volume guarantee
- PlimVG: pressure limit level of volume guarantee
- P<sub>insp</sub>: Peak inspiratory airway pressure
- Rate: Breath rate
- I:E: Ratio of inspiratory time to expiratory time

**NOTE:** The screen displays the calculated T<sub>insp</sub> when adjusting the I:E ratio.

- PEEP: Positive end-expiratory pressure
- Tslope: Rise time

**NOTE:** Before activating a new mechanical ventilation mode, ensure that all related parameters are set appropriately.

### 5.5.8 Synchronized Intermittent Mandatory Ventilation (SIMV)

The A7 supports two modes of SIMV: SIMV-volume control (SIMV-VC) and SIMV-pressure control (SIMV-PC).

### 5.5.8.1 Pressure Support in Synchronized Intermittent Mandatory Ventilation (SIMV)

In SIMV-VC and SIMV-PC Ventilation modes, PS Ventilation can be turned on and off by changing the PS setting to On and Off, respectively. When PS Ventilation is Off, the  $\Delta P$  and Tslope settings are disabled in SIMV-VC mode, and the  $\Delta P$  setting is disabled in SIMV-PC mode.

### 5.5.8.2 Synchronized Intermittent Mandatory Ventilation–Volume Control (SIMV-VC)



**FIGURE 5-12** Synchronized Intermittent Mandatory Ventilation–Volume Control (SIMV-VC) Tab

SIMV-VC means to deliver synchronized intermittent mandatory volume controlled ventilation to the patient. In the SIMV-VC mode, the ventilator waits for patient's next inspiration based on the specified time interval. The sensitivity depends on Trigger. If Trigger is reached within the trigger waiting time (called synchronous trigger window), the ventilator delivers volume controlled ventilation synchronously with the preset tidal volume and inspiratory time. If the patient does not inspire within the trigger window, the ventilator delivers volume controlled ventilation to the patient at the end of trigger window. Spontaneous breathing outside trigger window can acquire pressure support.

In VCV and SIMV-VC modes, when inspiration pressure reaches P<sub>limit</sub>, the inspiration pressure is held.

### 5.5.8.3 Synchronized Intermittent Mandatory Ventilation–Pressure Control (SIMV-PC)





**FIGURE 5-13** Synchronized Intermittent Mandatory Ventilation–Pressure Control (SIMV-PC) Tab

SIMV-PC means to deliver synchronized intermittent mandatory pressure controlled ventilation to the patient. In the SIMV-PC mode, the ventilator waits for patient's next inspiration based on the specified time interval. The sensitivity depends on Trigger. If Trigger is reached within the trigger waiting time (called synchronous trigger window), the ventilator delivers pressure controlled ventilation synchronously with the preset inspiratory pressure and inspiratory time. If the patient does not inspire within the trigger window, the ventilator delivers pressure controlled ventilation to the patient at the end of trigger window. Spontaneous breathing outside trigger window can acquire pressure support.

### 5.5.8.4 To Set SIMV-VC or SIMV-PC Mode

1. Select the **SIMV-VC** tab or **SIMV-PC** tab on the main screen.
2. Check that all **SIMV-VC** or **SIMV-PC** parameters are set appropriately.  
If necessary, select the parameter softkey to edit the parameters settings (see FIGURE 5-13).  
You can use the digital keyboard on the screen to enter the desired value, or continuously



press the  or  buttons to rapidly increase or decrease the parameter values.

3. Select the **Set Mode** softkey to confirm.

#### **SIMV-VC parameters:**

- Vt: Tidal volume
- Rate: Breath rate
- Tinsp: Time of inspiration

**NOTE:** The screen displays the calculated I:E ratio based on Rate and Tinsp when adjusting the Tinsp.

- Tpause: Inspiratory pause
- PEEP: Positive end-expiratory pressure
- Plimit: Pressure limit level
- Trigger: Flow trigger level
- PS: Pressure support
- ΔP: Change in pressure
- Tslope: Rise time

#### **SIMV-PC parameters:**

- Pinsp: Peak inspiratory airway pressure
- Rate: Breath rate
- Tinsp: Time of inspiration

**NOTE:** The screen displays the calculated I:E ratio based on Rate and Tinsp when adjusting the Tinsp.

- Trigger: Flow trigger level
- PEEP: Positive end-expiratory pressure
- Tslope: Rise time
- PS: Pressure support
- $\Delta P$ : Change in pressure

**NOTE:** Before activating a new mechanical ventilation mode, ensure that all related parameters are set appropriately.

## 5.5.9 Pressure Support Ventilation (PS)

In Pressure Support (PS) mode, the patient's effort is supported by the A7 at a preset level of inspiratory pressure. Inspiration is triggered and cycled by patient effort.

The user can set the Trigger flow,  $\Delta P$ , PEEP, minimum allowed breathing frequency, and Slope Time. If the Min Rate (bpm) is violated, the A7 will give an Apnea Ventilation breath to assure ventilation is occurring.



**FIGURE 5-14** Pressure Support Tab

### 5.5.9.1 To Set PS Mode

1. Select the **PS** tab on the main screen.
2. Check that all **PS** parameters are set appropriately. If necessary, select the parameter softkey to edit the parameters settings (see FIGURE 5-14). You can use the digital keyboard on the screen to enter the desired value, or continuously



press the  or  buttons to rapidly increase or decrease the parameter values.

3. Select the **Set Mode** softkey to confirm.

#### **PS parameters:**

- Min Rate: Minimum rate, applies to apnea backup breaths only
- $\Delta P$ : Change in pressure
- Trigger: Flow trigger level
- PEEP: Positive end-expiratory pressure
- Tslope: Rise time
- Apnea Ti: Apnea Inspiratory Time

**NOTE:** Apnea Ti permits the user to vary the inspiratory time of the apnea backup breaths. Apnea backup breaths are only triggered when the patient does not achieve the Min Rate that is set by the user. If the patient's spontaneous breaths meet or exceed the Min Rate, the apnea backup is not used.

**NOTE:** Before activating a new mechanical ventilation mode, ensure that all related parameters are set appropriately.

### 5.5.10 Auxiliary Common Gas Outlet (ACGO) Mode

The system is configured with an electronically controlled ACGO, the system enters and exits ACGO mode by setting the ACGO to On and Off on the screen.



**FIGURE 5-15** ACGO mode



**FIGURE 5-16** Standby mode

### 5.5.11 Monitor Mode

Monitor mode is only available in the Manual ventilation mode when there is an AG module connected to the A7. This mode turns off all ventilation related alarms.

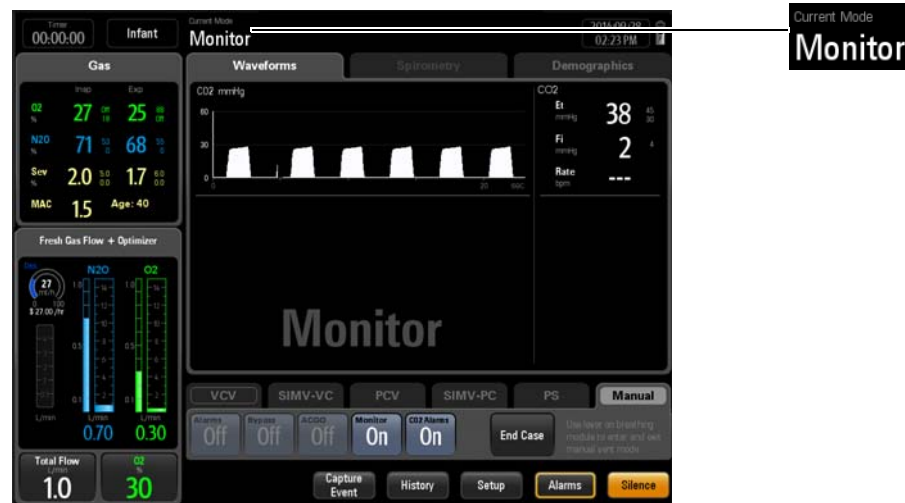
**NOTE:** When Monitor mode is On, the Alarms button is disabled and set to Off.

A confirmation dialog displays when turning Monitor mode On or Off.

Enter the Monitor mode by setting the **Monitor** softkey in **Manual** mode to On. When the **Monitor** softkey is set to **On**, the **Alarm** softkey is disabled and set to **Off** automatically. When **Monitor** is set to **Off**, the **Alarm** button restores to its settings before entering the Monitor mode. When exiting Manual mode or discharging a patient, **Monitor** is set to **Off**.

When the system is working in **Monitor** mode, the flow, volume and pressure waveforms and measured values are removed from the **Waveforms** tab. Only the CO<sub>2</sub> waveform and the CO<sub>2</sub> parameters remain on the **Waveforms** tab. The Rate as determined by the AG module displays in the measured values area.

The current mode area displays **Monitor** when **Monitor** is On.



**FIGURE 5-17** Monitor Mode

## 5.6 Start Mechanical Ventilation

**NOTE:** Before starting a new mechanical ventilation mode, ensure that all related ventilation parameters are set appropriately.

To start mechanical ventilation from the Standby mode:

1. Set the **Auto/Manual** ventilation switch to **Manual**.
2. Exit **Standby** by touching the main screen or by turning on the fresh gas.
3. Set the **Auto/Manual** ventilation switch to **Auto**. The A7 System begins mechanical ventilation.

## 5.7 Stop Mechanical Ventilation

To stop mechanical ventilation:

1. Ensure that the breathing system is set up and the APL valve is set properly before stopping mechanical ventilation.
2. Set the **Auto/Manual** ventilation switch to **Manual**. The A7 System stops mechanical ventilation.

## 5.8 Relationships of Ventilation Parameters

Ventilation modes may share the same ventilation parameters and values. For example, SIMV-VC and VCV both include Vt, Plimit, Rate, Tpause, and PEEP. Therefore, these parameter values that are linked may be passed from the previous ventilation mode to the current mode. Section C.9 "Linked Ventilation Parameter" on page C-11 includes a table that lists how the linked parameter values are set when changing ventilation modes.

Unlinked ventilation parameter values are set according to relationship equations. Section C.10 "Ventilation Parameter Relationships" on page C-13 includes a table of equations to show how unlinked parameter values are set when changing ventilation modes.

## 5.9 Parameter Monitoring (Numerics)

The system displays parameter monitored values in the monitored parameter area. The monitored parameters are separated into three groups: pressure, volume and gas (available with the AG module).

### 5.9.1 Pressure

The **Pressure** parameter group consists of three(3) parameters:

- Airway Peak Pressure (PEAK)
- Plateau Pressure (PLAT) or Mean Pressure (MEAN)
- Positive End Expiratory Pressure (PEEP)

If the parameter data is out of range, it displays as "-- --".

**NOTE:** The high alarm limit for Airway Peak Pressure (PEAK) displays to the top right of the reading. The low alarm limit for Airway Peak Pressure (PEAK) displays to the bottom right of the reading.

**NOTE:** Configure the display of either Plateau Pressure (PLAT) or Mean Pressure (MEAN) from the System menu tab.





**FIGURE 5-18** Pressure Parameter Group

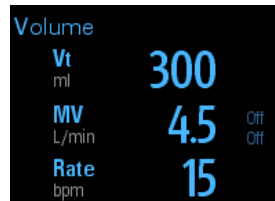
## 5.9.2 Volume

The **Volume** parameter group consists of three(3) parameters:

- Tidal Volume ( $V_T$ )
- Minute Volume (MV)
- Respiratory Rate (Rate)

If the parameter data is out of range, it displays as “---”.

**NOTE:** The high alarm limit for Minute Volume (MV) displays to the top right of the reading. The low alarm limit for Minute Volume (MV) displays to the bottom right of the reading.



**FIGURE 5-19** Volume Parameter Group

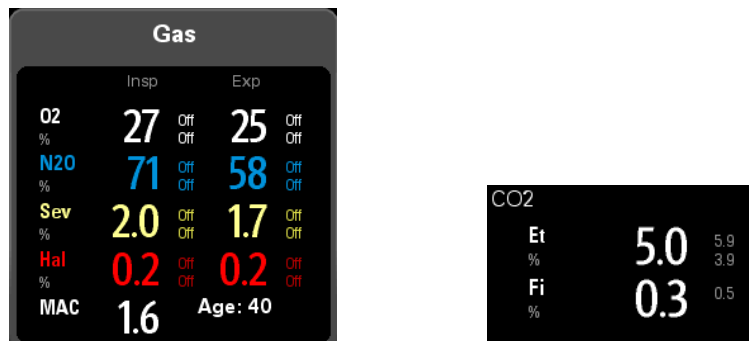
## 5.9.3 Gas

The gas monitored parameter group consists of the following parameters:

- Fraction of inspired carbon dioxide and End-tidal carbon dioxide (FiCO<sub>2</sub> and EtCO<sub>2</sub>)
- Fraction of inspired oxygen and End-tidal oxygen (FiO<sub>2</sub> and EtO<sub>2</sub>)
- Fraction of inspired nitrous oxide and End-tidal nitrous oxide (FiN<sub>2</sub>O and EtN<sub>2</sub>O)
- Fraction of inspired anesthetic agent and End-tidal anesthetic agent (FiAA and EtAA, AA stands for anesthetic agent)
- Minimum alveolar concentration (MAC)
- Age

If the parameter data is out of range, it displays as “---”.

**NOTE:** The high alarm limit is displayed to the top right of the reading. The low alarm limit is displayed to the bottom right of the reading.



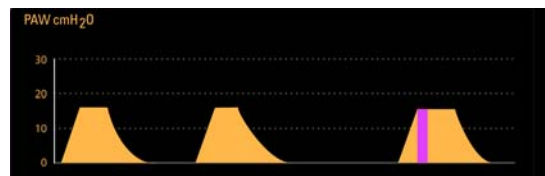
**FIGURE 5-20** Gas Parameter Group

## 5.10 Parameter Monitoring (Waveforms)

The system displays waveforms in the waveforms / spirometry area. The waveforms are separated into four groups: pressure waveform, flow waveform, volume waveform and gas waveform (available with the AG module).

### 5.10.1 Pressure Waveform

The **Pressure vs. Time** waveform displays in the waveform area.



**FIGURE 5-21** Example Simulated Pressure vs. Time Waveform

#### Pressure vs. Time

The Y-axis of the Pressure vs. Time waveform is labeled **PAW** (which represents **Airway Pressure**). The unit of measure is **cmH<sub>2</sub>O**, **hPa**, or **mbar**. The Y-axis automatically adjusts the scales. Though the X-axis is not labeled, it represents a time scale of 0 to 15 seconds.

**NOTE:** The purple in the waveform means it is a triggered breath.

#### 5.10.1.1 Auto-zeroing the Pressure Sensors

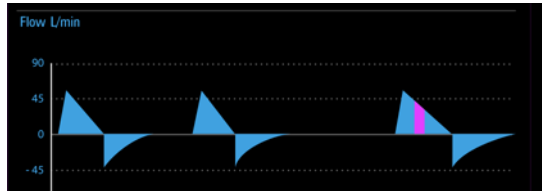
The A7 auto-zeros the pressure sensors at regular intervals to compensate for changes in temperature and/or barometric pressure that could affect both pressure and flow measurements. This may affect the waveforms on the screen, but does not affect the volume/pressure delivered to the patient.

The auto-zeroing intervals are: startup, 5 mins, 15 mins, 30 mins, 60 mins, and every 120 mins thereafter.

**NOTE:** The A7 displays the message "Auto-zeroing in process" during the auto-zeroing intervals.

### 5.10.2 Flow Waveform

The **Flow vs. Time** waveform displays in the waveform area.



**FIGURE 5-22** Example Simulated Flow vs. Time Waveform

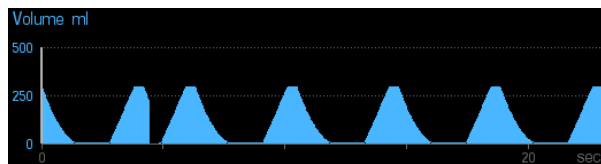
#### Flow vs. Time

The Y-axis of the Flow vs. Time waveform represents **Flow**. The unit of measure is **L/min**. The Y-axis automatically adjusts the scales. Though the X-axis is not labeled, it represents a time scale of 0 to 15 seconds.

**NOTE:** The purple in the waveform means it is a triggered breath.

### 5.10.3 Volume Waveform

The **Volume vs. Time** waveform displays in the waveform area. The default waveform displayed on the waveform area is **Flow vs. Time** waveform. Select **Setup** softkey > **Display** tab > **Waveform Display** button and select **Volume** to set the waveform display.



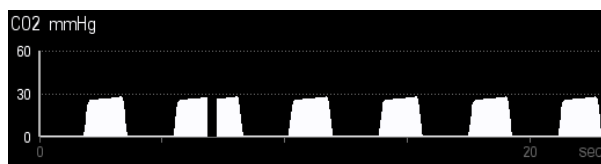
**FIGURE 5-23** Example Simulated Volume vs. Time Waveform

#### Volume vs. Time

The Y-axis of the Volume vs. Time waveform is labeled **Volume**. The unit of measure is **ml**. The Y-axis automatically adjusts the scales. Though the X-axis is not labeled, it represents a time scale of 0 to 15 seconds.

### 5.10.4 Gas Waveform

The **CO<sub>2</sub> vs. Time** waveform displays in the waveform area.

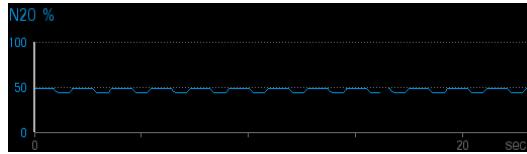


**FIGURE 5-24** Example Simulated CO<sub>2</sub> vs. Time Waveform

**CO<sub>2</sub> vs. Time**

The Y-axis of the CO<sub>2</sub> vs. Time waveform is labeled **CO<sub>2</sub>**. The unit of measure is **mmHg, kPa, or %**. The Y-axis automatically adjusts the scales. Though the X-axis is not labeled, it represents a time scale of 0 to 15 seconds.

The **N<sub>2</sub>O vs. Time** waveform is displayed in the waveform area.

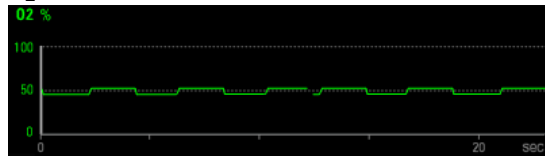


**FIGURE 5-25** Example Simulated N<sub>2</sub>O vs. Time Waveform (available with the AG module)

**N<sub>2</sub>O vs. Time**

The Y-axis of the N<sub>2</sub>O vs. Time waveform is labeled **N<sub>2</sub>O**. The unit of measure is **%**. You can adjust the scales of the Y-axis (see “Gas Scales” on page 3-40). Though the X-axis is not labeled, it represents a time scale of 0 to 15 seconds.

**O<sub>2</sub> vs. Time** waveform is displayed in the waveform area.



**FIGURE 5-26** Example Simulated O<sub>2</sub> vs. Time Waveform (available with the AG module)

**O<sub>2</sub> vs. Time**

The Y-axis of the O<sub>2</sub> vs. Time waveform is labeled **O<sub>2</sub>**. The unit of measure is **%**. You can adjust the scales of the Y-axis (see “Gas Scales” on page 3-40). Though the X-axis is not labeled, it represents a time scale of 0 to 15 seconds.

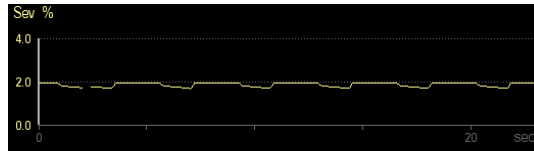
**AA vs. Time** waveform is displayed in the waveform area.



**FIGURE 5-27** Example Simulated AA vs. Time Waveform (available with the AG module)

### AA vs. Time

The Y-axis of the AA vs. Time waveform is labeled AA. The unit of measure is %. You can adjust the scales of the Y-axis (see "Gas Scales" on page 3-40). Though the X-axis is not labeled, it represents a time scale of 0 to 15 seconds. If no agent is detected, the system displays AA vs. Time waveform (see FIGURE 5-27). If an anesthetic agent such as sevoflurane is detected, the system displays Sev vs. Time waveform (see FIGURE 5-28).



**FIGURE 5-28** Example Simulated Sev vs. Time Waveform (available with the AG module)

## 5.10.5 Waveform Autoscaling

If the measured values of Paw, Flow, or Volume are larger than the boundary at the end of the breath cycle, the system autoscales the Paw, Flow, or Volume at the beginning of next breath cycle.

If the measured values of Paw, Flow, or Volume are less than the boundary minus a margin (see TABLE 5-1) at the end of two continuous breath cycles, the system autoscales the Paw, Flow, or Volume at the beginning of the next breath cycle.

SCALE	MARGIN
Paw	3 cmH <sub>2</sub> O if Paw < 30 cmH <sub>2</sub> O 10 cmH <sub>2</sub> O if Paw ≥ 30 cmH <sub>2</sub> O
Flow	10 L/min if Flow ≤ 30 L/min 15 L/min if Flow > 30 L/min
Volume	25 ml if volume ≤ 100 ml 100 ml if volume > 100 ml

**TABLE 5-1** Autoscaling Margins of Paw, Flow, and Volume

## 5.11 Parameter Monitoring (Spirometry)

Spirometry is a respiratory monitoring technology that provides continuous (breath-by-breath) measurement of patient lung mechanics. The resultant pressure, volume, flow, compliance, and resistance data enables quick assessment of the patient's pulmonary status.

Select the **Spirometry** tab to open the **Spirometry Loop** window (See section 3.5 (page 3-18) "Spirometry Tab").

**NOTE:** **The spirometry and waveforms can be displayed on the same screen.**

Currently plotting loop, reference loop, and baseline loop display in manual and mechanical ventilation modes.

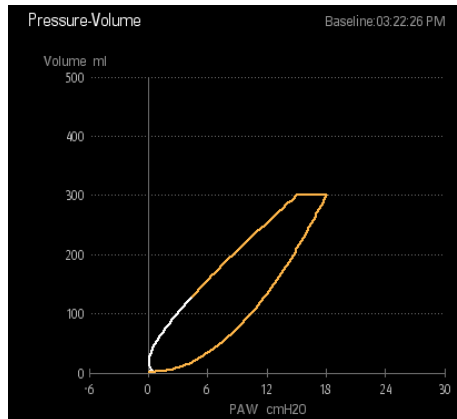
Discharging the patient clears spirometry loops (baseline and reference loops).

Restarting the machine clears spirometry loops (baseline and reference loops).

Spirometry is disabled in **Bypass** mode. If **Bypass** mode is entered when the **Spirometry** tab opens, the system switches to the **Waveforms** tab.

## Pressure - Volume Spirometry Loop

FIGURE 5-29 is an example of the Pressure - Volume loop.

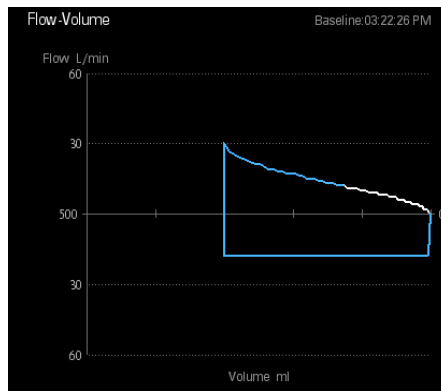


**FIGURE 5-29** Pressure - Volume Loop

The Y-axis of the Pressure - Volume Spirometry loop represents **Volume**. The X-axis labeled **PAW** represents airway pressure.

## Flow - Volume Spirometry Loop

FIGURE 5-30 is an example of the Flow - Volume loop.

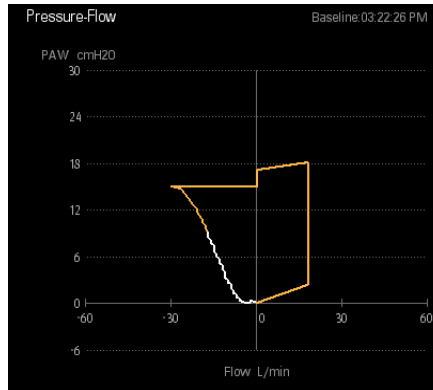


**FIGURE 5-30** Flow - Volume Loop

The Y-axis of the Flow - Volume Spirometry loop represents **Flow**. The X-axis represents **Volume**.

## Pressure - Flow Spirometry Loop

FIGURE 5-31 is an example of the Pressure - Flow loop.



**FIGURE 5-31** Pressure - Flow Loop

The Y-axis of the Pressure - Flow Spirometry loop labeled **PAW** represents airway pressure. The X-axis represents **Flow**.

**This page intentionally left blank.**



# ***Alarms and Messages***

---

Introduction .....	6-2
Displaying Alarms.....	6-5
Setting Alarm Volume.....	6-7
Silencing Alarms.....	6-8
Alarm Limits .....	6-9
Alarm and Prompt Messages .....	6-14

## 6.1 Introduction

The A7 System provides alarms and messages that are indicated to the user by visual and audible alerts. Alarms and messages display at the top of the main screen and in the **Alarms** window (see FIGURE 6-1). Users can adjust alarm properties, which include setting alarm limits to trigger alarm conditions, adjusting alarm volume, and silencing alarms.



**FIGURE 6-1** Alarms and Messages On The Main Screen and In The Alarms Window

### 6.1.1 Alarm System Self-Test

The A7 System performs a self-test of its alarm system when powered on. The self-test includes the alarm LED and speaker as follows:

- During the self-test, the alarm LED illuminates in sequence with the colors red, yellow, and cyan for approximately 1 second each color.
- The system speaker produces one tone after the alarm light is in self-test.

## 6.1.2 Types of Alarms and Messages

The A7 provides the following types of alarms and messages below. See section 6.6 (page 6-14) "Alarm and Prompt Messages" for the list of alarms and messages:

- **Physiological Alarm:**  
Patient-related variables cause physiological alarms. These alarms require a user response and may have a high, medium, or low priority.
- **Technical Alarm:**  
Machine-related variables cause technical alarms. These alarms require a user response and may have a high, medium, or low priority.
- **Prompt Message:**  
This is a message to the user. They do not require a user response. These messages always have the lowest priority, below physiological and technical alarms, and display in white.







### 6.1.3 Alarm Indicators

The A7 provides the following alarm indicators:

- **An alarm LED located on top of the LCD monitor.** The LED can illuminate red, yellow, cyan, or OFF depending on the alarm condition.

Table describes the alarm behavior of different alarm types and different alarm priority labels. If multiple alarms occur simultaneously, the audio and LED behavior follows the highest priority active alarm.

- **Colored alarm messages display on the main screen.** High priority messages are red. Medium priority messages are yellow. Low priority messages are cyan. Prompt messages are white. Messages display according to priority and time. (See “Displayed Order of Alarm Messages” on page 6-6.)
- **Alarm audio through the system alarm speaker.** Table lists the audio behavior for each alarm type.

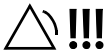


ALARM TYPE	ALARM PRIORITY	AUDIO BEHAVIOR	MESSAGE BEHAVIOR	ALARM LED COLOR
<b>Physiological Alarm</b>	High	Play high priority alarm sound, the interval between each play is $5 \pm 1$ sec.	White text red background, high priority icon. 	Red
	Medium	Play medium priority alarm sound, the interval between each play is $5 \pm 1$ sec.	Black text yellow background, medium priority icon. 	Yellow
	Low	Play low priority alarm sound, the interval between each play is $17 \pm 1$ sec.	White text cyan background, low priority icon. 	Cyan
<b>Technical Alarm</b>	High	Play high priority alarm sound, the interval between each play is $5 \pm 1$ sec.	White text red background, high priority icon. 	Red
	Medium	Play medium priority alarm sound, the interval between each play is $5 \pm 1$ sec.	Black text yellow background, medium priority icon. 	Yellow
	Low	Play low priority alarm sound, the interval between each play is $17 \pm 1$ sec.	White text cyan background, low priority icon. 	Cyan
<b>Prompt Message</b>	None	None	Black text white background	Off

**TABLE 6-1** Alarm indicators (audio and on-screen messages)

## 6.2 Displaying Alarms

On the LCD monitor screen, alarm messages automatically display at the top area of the main screen when alarm conditions occur (see FIGURE 6-3). Additionally, a list of all active alarms and an alarm log can be found in the **Alarms** window. (see FIGURE 6-2)

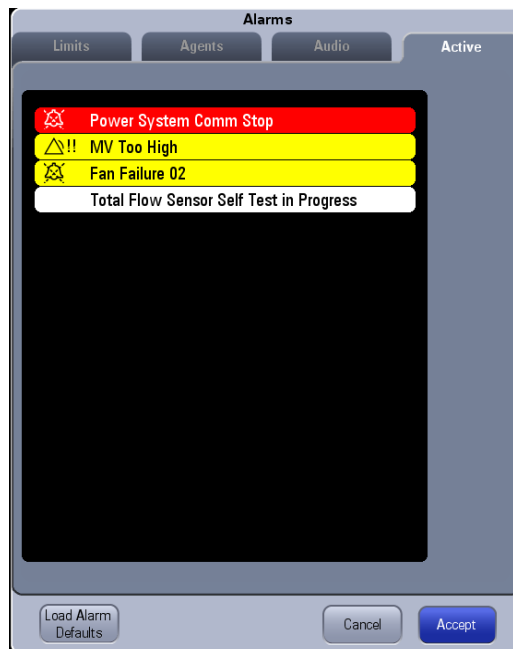
Each message displays with an associated priority symbol as follows:

- High priority 
- Medium priority 
- Low priority 

To display a list of all active alarms:

1. On the main screen, select the **Alarms** softkey or touch the Alarm Message area at the top of the screen.  
The **Alarms** window displays.
2. Select the **Active** tab.  
A list of all active alarm messages display (see FIGURE 6-2). Up to 15 current alarms display on screen, after which a scroll bar is used to display the remaining alarms.

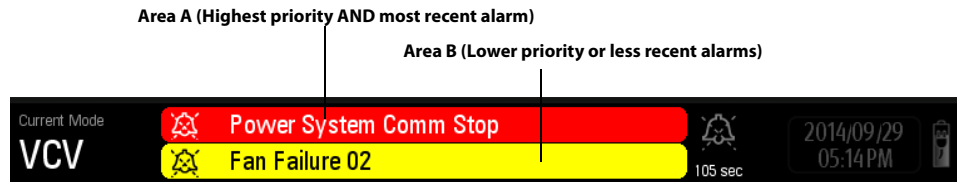
Alarms display in order of priority and time. See section 6.2.1 (page 6-6) "Displayed Order of Alarm Messages" for more information.



**FIGURE 6-2** Active Alarms list in the Alarms window

## 6.2.1 Displayed Order of Alarm Messages

Alarm messages display in order of priority and time of occurrence. FIGURE 6-3 shows the alarm messages list divided into two areas (Area A and Area B).



**FIGURE 6-3** Displayed order of alarm messages

Alarm messages display in Area A and Area B according to the following rules:

- To be in Area A, an alarm must be both the highest priority AND the most recent (Area A does not cycle). The remaining active alarms and prompt messages cycle in Area B.
- New alarms with a lower priority than alarms in Area A display immediately in Area B, and the cycle proceeds from that position in the list.
- Alarms cycling in Area B are grouped and display in the following priority order: high, medium, low, and prompt messages. In each group, the most recent alarm displays first.
- If the alarm in Area A is removed, then the most recent and highest priority alarm from Area B is moved to Area A.

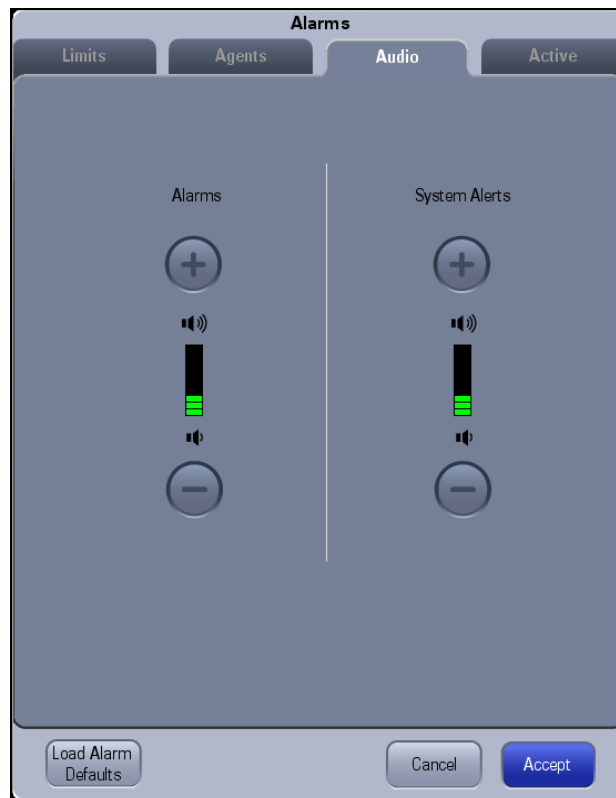
## 6.3 Setting Alarm Volume

Users can set the audio level of alarms and system alerts by selecting the **Alarms** softkey on the main screen to display the **Alarms** window (see FIGURE 6-4).

The **Alarms** volume settings adjust the audio level of all high, medium, and low priority sounding alarms. The **System Alerts** volume settings adjust the audio level of all sounding pop-up prompts and non-confirmed ventilation mode alerts.

To set the alarm volume:

1. On the main screen, select the **Alarms** softkey.  
The **Alarms** window is displayed.
2. Select the **Audio** tab.  
Volume controls for **Alarms** and **System Alerts** display.
3. Adjust the volume by selecting the + (increase) or – (decrease) buttons.  
The Alarms volume has 10 levels of adjustment. Default level is 3.  
The System Alerts volume has 10 levels of adjustment. Default level is 3.
4. Select the **Accept** softkey to confirm the change, or select the **Cancel** softkey to disregard the change.



**FIGURE 6-4** Audio Tab

**WARNING:** Do not rely exclusively on the audible alarm system when using the A7 Anesthesia System. Adjustment of alarm volume to a low level may result in a hazard to the patient. Always keep the patient under close surveillance.

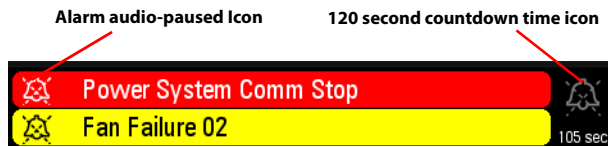
## 6.4 Silencing Alarms

When an alarm condition occurs and the alarm audio sounds, the user can select the **Silence** softkey at the bottom of screen to silence the alarm audio. In silenced status, all the alarm indicators work normally except audible alarm tones.

When the **Silence** softkey is selected, all active alarms are silenced and the icon on the left side of the alarm message changes to indicate that the alarm is silenced. When the 120 second silence icon appears, the audio alarms are silenced for 120 seconds, after which the audio alarms resume.

If you select the **Silence** softkey while all alarms are silenced, then the audio alarms will resume immediately.

**NOTE:** A new alarm will sound if that alarm occurs while the system is in a silenced state. If this occurs, you can select the Silence softkey again to silence the new alarm and reset the silence countdown timer to 120 seconds.



**FIGURE 6-5** Alarm audio-paused



## 6.5 Alarm Limits

### 6.5.1 Setting Alarm Limits

Users can set the alarm limits of Paw, MV, FiO<sub>2</sub>, EtO<sub>2</sub>, FiN<sub>2</sub>O, EtN<sub>2</sub>O and FiCO<sub>2</sub> to create alarm conditions consistent with patient needs. The alarm is then triggered when the parameter value is greater than the high limit or lesser than the low limit.

**NOTE:** When using the A7 Anesthesia System, ensure that the alarm limits of each parameter are set to the appropriate values for the patient.

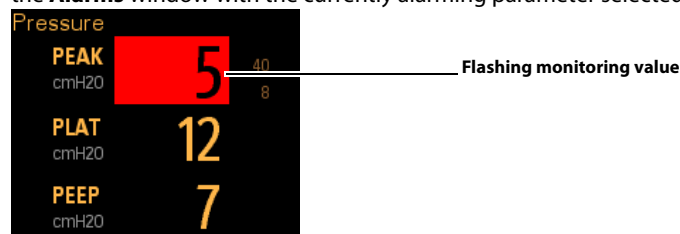
There are two ways to set alarm limits:



1. On the main screen, select the **Alarms** softkey. The **Alarms** window displays.

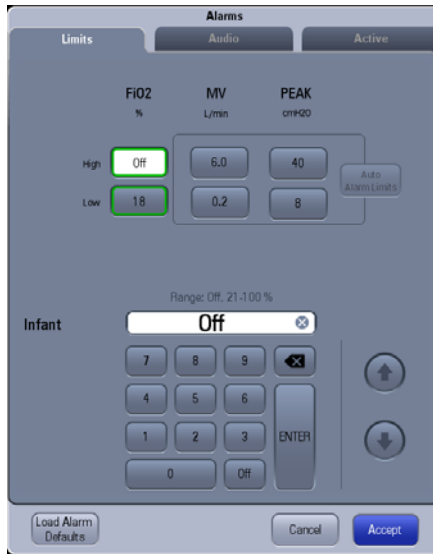


or

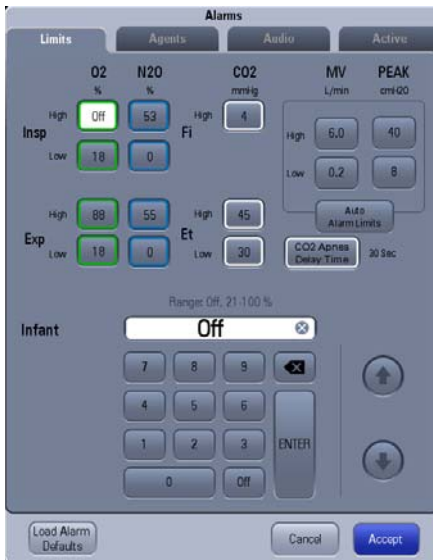
When the monitoring value on the main screen is flashing, select the flashing area to open the **Alarms** window with the currently alarming parameter selected.



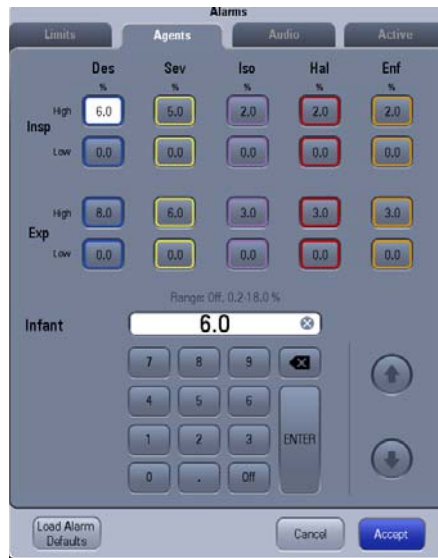
2. Select the **Limits** tab or **Agents** tab. (see FIGURE 6-6 and FIGURE 6-7.)
3. Select a parameter softkey.  
The softkey highlights when selected.
4. Use the on-screen keypad to enter the desired parameter value, or continuously press the  or  buttons to rapidly increase or decrease the parameter value. For each parameter, the range of values displays above the keypad. The section "Alarm Limits" on page C-2 also lists the range of values for the parameters.
5. Optionally, to restore the default values, select the **Load Alarm Defaults** button. This restores the high and low values for the parameters to the user default values.
6. Repeat steps 3 to 4 for each parameter value.
7. Select the **Accept** softkey to confirm the change, or select the **Cancel** softkey to disregard the change.



**FIGURE 6-6** Limits tab in the Alarms Window (without AG module connected)



**FIGURE 6-7** Limits tab in the Alarms Window (with AG module connected)



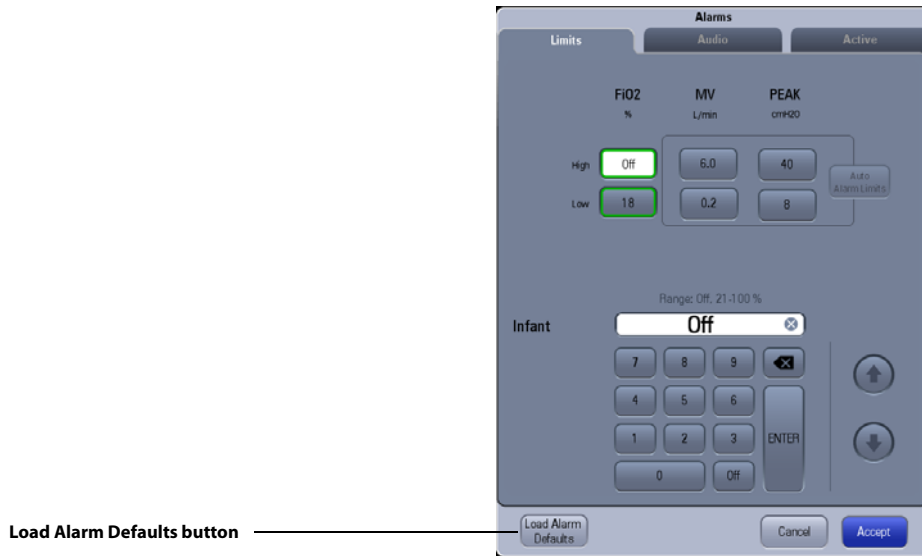
**FIGURE 6-8** Agents tab in the Alarms Window (with AG module connected)

## 6.5.2 Loading Alarm Defaults

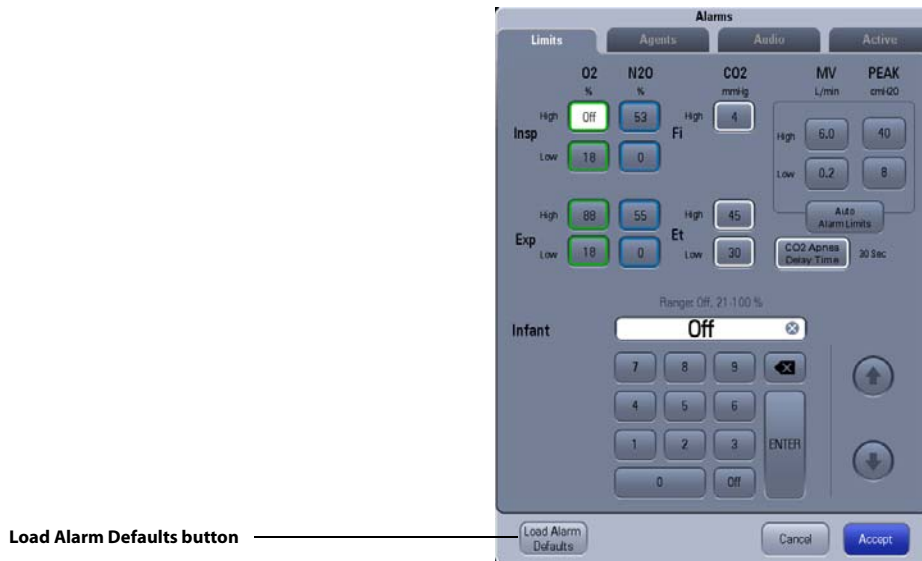
Users can load the user alarm limit defaults of all modules from the **Alarms** window.

To load alarm limit defaults:

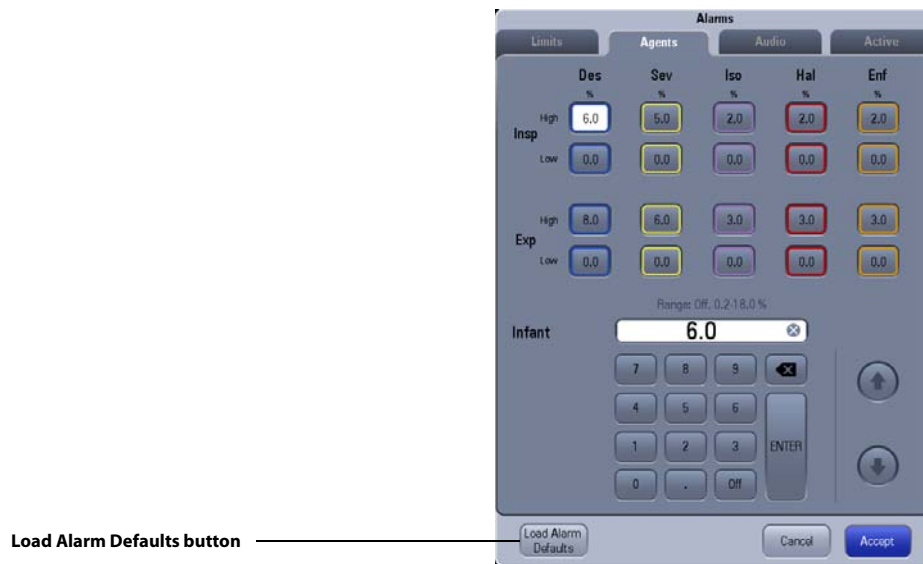
1. On the **Main Screen**, select the **Alarms** softkey. The **Alarms** window is displayed.
2. Select the **Load Alarm Defaults** button at the bottom of the **Alarms** window. This restores the high and low values for the parameters to the user default values.
3. Select the **Accept** button to save these settings and close the **Alarms** window.



**FIGURE 6-9** Load Alarm Defaults button in the **Alarms** window (without AG module connected)



**FIGURE 6-10** Load Alarm Defaults button in the **Alarms** window (with AG module connected)



**FIGURE 6-11** Load Alarm Defaults button in the Agents window (with AG module connected)

### 6.5.3 Auto Alarm Limits

The Auto Alarm Limits function uses an algorithm based on measured values. The relationship is shown in the TABLE 6-2.

The **Auto Alarm Limits** button is disabled when the A7 is in **Standby** mode, **Manual** mode or **Monitor** mode. The **Auto Alarm Limits** button is also disabled when the current mode is PS, SIMV-VC, or SIMV-PC.

ALARM LIMIT	ADJUST FORMULA
<b>Paw High</b>	PEAK+5 or PLAT+10, whichever is greater minimum 35 cmH <sub>2</sub> O
<b>Paw Low</b>	(PLAT-PEEP) x 0.6 + PEEP - 1 minimum 3 cmH <sub>2</sub> O maximum Paw High - 1
<b>MV High</b>	MV x 1.4 minimum 2.0 L/min
<b>MV Low</b>	MV x 0.6 minimum 0.3 L/min maximum MV High - 0.1

**TABLE 6-2** Auto Alarm Limits

The parameters in the formula are all measured parameters. The new alarm limits for Paw are calculated on the basis of average values for PEAK, PLAT, and PEEP. The value used for average uses the value of the last four ventilation cycles or the value in one minute, whichever is smaller. Spontaneous breaths by the patient are not taken into account.

If there is not a valid measured minute volume (MV), the corresponding MV alarm limits will not adjust.

If the average value for PEAK, PLAT, and PEEP cannot be calculated, the corresponding alarm limits will not adjust.

If the calculated alarm limit is more than the high threshold of setting range or less than the low threshold, the corresponding threshold is used as the auto alarm limit.

### 6.5.4 Setting CO<sub>2</sub> Apnea Delay Time (software bundle version 02.09.00 and later)

The **Apnea CO<sub>2</sub>** alarm is triggered when no breath is detected within a specified time.

**To set the CO<sub>2</sub> Apnea Delay Time:**

1. On the main screen, select the **Alarms** softkey.  
The **Alarms** window displays.
2. Select the **Limits** tab. (see FIGURE 6-6)
3. Select the **CO<sub>2</sub> Apnea Delay Time** button and set it to **10 sec, 15 sec, 20 sec, 25 sec, 30 sec, 35 sec, or 40 sec.**

## 6.6 Alarm and Prompt Messages

This section lists the following alarms and messages:

- Physiological Alarm Messages
- Technical Alarm Messages
- Prompt Messages

For each alarm message, corresponding actions are given instructing you to troubleshoot problems. If the problem persists, contact your service personnel.

**NOTE:**        **The Disable in Manual and Cardiac Bypass mode column indicates how this alarm is controlled by the alarm on/off button and the cardiac bypass mode button in manual mode.**

**NOTE:**        **The Disabled in Standby mode column indicates which physiological alarms will be automatically disabled in the Standby mode.**

**NOTE:**        **The Disabled in Monitor mode column indicates which physiological alarms will be automatically disabled in the Monitor mode.**

## 6.6.1 Physiological Alarm Messages

MESSAGE	CAUSE	ALARM PRIORITY	DISABLED WHEN ALARM IS OFF	DISABLED IN STANDBY MODE	DISABLED IN MONITOR MODE
<b>Apnea</b>	Two triggering conditions occur simultaneously: 1. Paw < (PEEP+3) cmH <sub>2</sub> O for more than 30 seconds 2. Vt < 10 ml for more than 30 seconds	Medium	Yes	N/A *	Yes
<b>Apnea &gt;2 min</b>	No breath has been detected within the last 120 seconds.	High	Yes	N/A *	Yes
<b>Paw Too High</b>	Paw ≥ high alarm limit setting	High	Yes	N/A *	Yes
<b>Paw Too Low</b>	Paw ≤ low alarm limit setting for 20 seconds	High	Yes	N/A *	Yes
<b>Pressure Limiting</b>	Paw ≥ Plimit	Low	N/A *	N/A *	N/A *
<b>FiO<sub>2</sub> Too High</b>	FiO <sub>2</sub> > high alarm limit setting	Medium	No	N/A *	No
<b>FiO<sub>2</sub> Too Low</b>	FiO <sub>2</sub> < low alarm limit setting	High	No	N/A *	No
<b>MV Too High</b>	MV > high alarm limit setting	Medium	Yes	N/A *	Yes
<b>MV Too Low</b>	MV < low alarm limit setting	Medium	Yes	N/A *	Yes
<b>Continuous Airway Pressure</b>	Paw in the breathing circuit > sustained airway pressure alarm limit for 15 seconds	High	No	N/A *	Yes
<b>Negative Pressure</b>	Paw < -10 cmH <sub>2</sub> O for 1 second.	High	No	N/A *	Yes
<b>EtCO<sub>2</sub> Too High</b>	EtCO <sub>2</sub> > high alarm limit setting	Medium	No	Yes	No
<b>EtCO<sub>2</sub> Too Low</b>	EtCO <sub>2</sub> < low alarm limit setting	Medium	No	Yes	No
<b>FiCO<sub>2</sub> Too High</b>	FiCO <sub>2</sub> > high alarm limit setting	Medium	No	Yes	No
<b>EtN<sub>2</sub>O Too High</b>	EtN <sub>2</sub> O > high alarm limit setting	Medium	No	Yes	No
<b>EtN<sub>2</sub>O Too Low</b>	EtN <sub>2</sub> O < low alarm limit setting	Medium	No	Yes	No
<b>FiN<sub>2</sub>O Too High</b>	FiN <sub>2</sub> O > high alarm limit setting	Medium	No	Yes	No
<b>FiN<sub>2</sub>O Too Low</b>	FiN <sub>2</sub> O < low alarm limit setting	Medium	No	Yes	No

\* N/A - Not Applicable. This alarm message does not exist within this mode and therefore cannot be disabled or enabled.

**TABLE 6-3** Physiological Alarm Messages

MESSAGE	CAUSE	ALARM PRIORITY	DISABLED WHEN ALARM IS OFF	DISABLED IN STANDBY MODE	DISABLED IN MONITOR MODE
<b>EtHAL Too High</b>	EtHAL > high alarm limit setting	Medium	No	Yes	No
<b>EtHAL Too Low</b>	EtHAL < low alarm limit setting	Medium	No	Yes	No
<b>FiHAL Too High</b>	FiHAL > high alarm limit setting	Medium	No	Yes	No
<b>FiHAL Too Low</b>	FiHAL < low alarm limit setting	Medium	No	Yes	No
<b>EtENF Too High</b>	EtENF > high alarm limit setting	Medium	No	Yes	No
<b>EtENF Too Low</b>	EtENF < low alarm limit setting	Medium	No	Yes	No
<b>FiENF Too High</b>	FiENF > high alarm limit setting	Medium	No	Yes	No
<b>FiENF Too Low</b>	FiENF < low alarm limit setting	Medium	No	Yes	No
<b>EtISO Too High</b>	EtISO > high alarm limit setting	Medium	No	Yes	No
<b>EtISO Too Low</b>	EtISO < low alarm limit setting	Medium	No	Yes	No
<b>FiISO Too High</b>	FiISO > high alarm limit setting	Medium	No	Yes	No
<b>FiISO Too Low</b>	FiISO < low alarm limit setting	Medium	No	Yes	No
<b>EtSEV Too High</b>	EtSEV > high alarm limit setting	Medium	No	Yes	No
<b>EtSEV Too Low</b>	EtSEV < low alarm limit setting	Medium	No	Yes	No
<b>FiSEV Too High</b>	FiSEV > high alarm limit setting	Medium	No	Yes	No
<b>FiSEV Too Low</b>	FiSEV < low alarm limit setting	Medium	No	Yes	No
<b>EtDES Too High</b>	EtDES > high alarm limit setting	Medium	No	Yes	No
<b>EtDES Too Low</b>	EtDES < low alarm limit setting	Medium	No	Yes	No
<b>FiDES Too High</b>	FiDES > high alarm limit setting	Medium	No	Yes	No
<b>FiDES Too Low</b>	FiDES < low alarm limit setting	Medium	No	Yes	No
<b>EtO<sub>2</sub> Too High</b>	EtO <sub>2</sub> > high alarm limit setting	Medium	No	Yes	No
<b>EtO<sub>2</sub> Too Low</b>	EtO <sub>2</sub> < low alarm limit setting	Medium	No	Yes	No

\* N/A - Not Applicable. This alarm message does not exist within this mode and therefore cannot be disabled or enabled.

**TABLE 6-3** Physiological Alarm Messages



MESSAGE	CAUSE	ALARM PRIORITY	DISABLED WHEN ALARM IS OFF	DISABLED IN STANDBY MODE	DISABLED IN MONITOR MODE
<b>FiO<sub>2</sub> Too High</b>	FiO <sub>2</sub> > high alarm limit setting	Medium	No	Yes	No
<b>FiO<sub>2</sub> Too Low</b>	FiO <sub>2</sub> < low alarm limit setting	Medium	No	Yes	No
<b>Apnea CO<sub>2</sub></b>	No breath is detected and Apnea time ≥ Apnea alarm time.	High	No	Yes	No

\* N/A - Not Applicable. This alarm message does not exist within this mode and therefore cannot be disabled or enabled.

**TABLE 6-3** Physiological Alarm Messages

**NOTE:** If an Apnea CO<sub>2</sub> alarm occurs, the CO<sub>2</sub> apnea elapse timer will display on the CO<sub>2</sub> waveform screen. The time displayed is the time since the last breath and the time will reset once the CO<sub>2</sub> Apnea alarm has cleared.

## 6.6.2 Technical Alarm Messages

### 6.6.2.1 Startup Alarm Messages

**NOTE:** Startup alarms will not trigger the alarm sound and alarm light.

**NOTE:** Startup alarms priority is only used to display in the Service menu alarm logbook.

**NOTE:** The Startup Result if Fail column indicates the result when this startup phase alarm is triggered, which may be ALL, only manual, and Non-Functional.

**NOTE:** "All" indicates that all Automatic Ventilation, Manual Ventilation, and Cardiac Bypass modes are enabled.

"Only Manual" indicates that only Manual Ventilation and Cardiac Bypass modes are enabled.

"Non-Functional" indicates that the A7 Anesthesia System cannot be used.

MESSAGE	CAUSE	ALARM PRIORITY	MACHINE MODE WHEN CHECKED	STARTUP RESULT IF FAIL	REMARK
<b>Bundle Version Error / Incompatible version found</b>	Incompatible firmware version is installed.	High	Startup	Non-Functional	CPU Board
<b>Bundle Version: Time out</b>	Self-test result cannot be obtained due to an internal communication error.	High	Startup	Non-Functional	CPU Board

**TABLE 6-4** Startup Alarm Messages

MESSAGE	CAUSE	ALARM PRIORITY	MACHINE MODE WHEN CHECKED	STARTUP RESULT IF FAIL	REMARK
<b>Flowmeter Self Test Error / Flowmeter Self Test Fail</b>	1. CPU Selftest Error 2. RAM Selftest Error 3. Address line Selftest Error 4. Watchdog Selftest Error 5. Flash Selftest Error 6. O <sub>2</sub> Proportional Valve Selftest Error 7. Air Proportional Valve Selftest Error 8. N <sub>2</sub> O Proportional Valve Selftest Error 9. O <sub>2</sub> Branch Circuit Leakage 10. Air Branch Circuit Leakage 11. N <sub>2</sub> O Branch Circuit Leakage 12. Read Zero Error 13. FPGA Configure Error	High	Startup	Non-Functional	Electronic Flowmeter Board
<b>Flowmeter Self Test: Time out</b>	Self-test result cannot be obtained due to an internal communication error.	High	Startup	Non-Functional	Electronic Flowmeter Board
<b>Aux Control Module Self Test Error / Aux Control Module Self Test: Fail</b>	1. CPU, Flash or WTD error 2. After power on, CPU board can't communicate with the Aux Control board.	High	Startup	Non-Functional	Aux Vent Control Board
<b>Aux Control Module Self Test: Time out</b>	Self-test result cannot be obtained due to an internal communication error.	High	Startup	Non-Functional	Aux Vent Control Board
<b>Ventilator Self Test Error / Ventilator Self Test: Fail</b>	1. CPU, TIMER, RAM, WTD, EEPROM or AD error 2. After power on, CPU board cannot communicate with the ventilator board.	High	Startup	Non-Functional	Ventilator Control Board
<b>Ventilator Self Test: Time out</b>	Self-test result cannot be obtained due to an internal communication error.	High	Startup	Non-Functional	Ventilator Control Board
<b>Ventilator Voltage Error / Ventilator Voltage: Fail</b>	5 V or 12 V voltage error	High	Startup	Only Manual	Ventilator Control Board

**TABLE 6-4** Startup Alarm Messages

MESSAGE	CAUSE	ALARM PRIORITY	MACHINE MODE WHEN CHECKED	STARTUP RESULT IF FAIL	REMARK
<b>PEEP Valve Failure / PEEP Valve: Fail</b>	1. PEEP valve voltage error. 2. PEEP valve pressure error.	Medium	Startup	Only Manual	Ventilator Control Board
<b>Insp Valve Failure / Insp Valve: Fail</b>	1. Inspiratory valve voltage error. 2. Inspiratory valve flow error.	Medium	Startup	Only Manual	Ventilator Control Board
<b>Safety Valve Failure / Safety Valve: Fail</b>	PEEP safety valve voltage error.	Medium	Startup	Only Manual	Ventilator Control Board
<b>Flow Sensor Failure / Flow Sensor: Fail</b>	Ventilator flow is out of range.	Low	Startup	Only Manual	Ventilator Control Board
<b>Calibrate Flow Sensor and Insp Valve</b>	1. Calibration table isn't found in EEPROM. 2. Checksum of Calibration table does not match.	Low	Startup	Only Manual	Ventilator Control Board
<b>Calibrate Pressure Sensor and PEEP Valve</b>	1. Calibration table isn't found in EEPROM. 2. Checksum of Calibration table does not match.	Low	Startup	Only Manual	Ventilator Control Board
<b>Ventilator Initialization Error / Ventilator Initialization: Fail</b>	After powering on, CPU board cannot send the parameter settings to the ventilator board.	High	Startup	Non-Functional	CPU Board
<b>Ventilator Initialization: Time out</b>	Self-test result cannot be obtained due to an internal communication error.	High	Startup	Non-Functional	CPU Board
<b>Drive Gas Pressure Low</b>	Drive Gas Pressure is low	High	Startup	All	Ventilator Control Board
<b>O<sub>2</sub> Supply Failure / O<sub>2</sub> Supply: Fail</b>	O <sub>2</sub> Supply Failure	High	Startup	All	Ventilator Control Board
<b>Power Supply Voltage Error / Power Supply Voltage: Fail</b>	3.3 V, 5 V, 12 V voltage error	High	Startup	Only Manual	Power Board
<b>RT Clock Needs Battery</b>	There is no button battery cell available in the system, or the button battery cell power is depleted.	High	Startup only	All	CPU Board
<b>RT Clock Failure / RT Clock: Fail</b>	RT chip malfunction	High	Startup only	All	CPU Board

**TABLE 6-4** Startup Alarm Messages

MESSAGE	CAUSE	ALARM PRIORITY	MACHINE MODE WHEN CHECKED	STARTUP RESULT IF FAIL	REMARK
<b>Keyboard Self Test Error</b>	Keyboard self-test Error	High	Startup only	Non-Functional	Keyboard
<b>Keyboard Self Test : Time out</b>	Keyboard self-test result cannot be obtained due to communication error.	High	Startup only	Non-Functional	Keyboard
<b>External AG Self Test Error</b>	If the module sends the ErrorMsg, except for data limit error and unspecified accuracy, "External AG Self Test Error" will be triggered.	Low	Startup only	All	AG Module
<b>Internal AG Error O<sub>2</sub></b>	If the module sends the ErrorMsg, except for data limit error and unspecified accuracy, "Internal AG Error O <sub>2</sub> " will be triggered.	Low	Startup only	All	AG Module
<b>External AG: Time out</b>	External AG selftest result cannot be obtained due to communication error.	Low	Startup only	All	AG Module
<b>Internal AG: Time out</b>	Internal AG selftest result cannot be obtained due to communication error.	Low	Startup only	All	AG Module

**TABLE 6-4** Startup Alarm Messages

### 6.6.2.2 CPU Board Runtime Alarm

MESSAGE	CAUSE	ALARM PRIORITY	MACHINE MODE WHEN CHECKED	DISABLE IN STANDBY MODE
<b>IP Address Conflict</b>	The IP address of the machine is the same as the IP address of another device in the local network.	Medium	Runtime	No
<b>Fan Failure</b>	Speed of the fan $\leq$ 20% of normal speed	Medium	Runtime	No
<b>Fan Failure O<sub>2</sub></b>	Speed of Module Rack fan < 3640	Medium	Runtime	No

**TABLE 6-5** CPU Board Runtime Alarm Messages

### 6.6.2.3 Power Board Runtime Alarm

MESSAGE	CAUSE	ALARM PRIORITY	MACHINE MODE WHEN CHECKED	DISABLE IN STANDBY MODE
<b>Power System Comm Stop</b>	Lost communication with CPU board for 10 seconds.	High	Runtime	No
<b>Power Supply Voltage Error</b>	3.3 V, 5 V, 12 V voltage error	High	Runtime	No
<b>Low Battery Voltage!</b>	Battery voltage is less than 10.6 V for 5 seconds.	High	Runtime	No
<b>System going DOWN, Battery depleted!</b>	Battery voltage is less than 10.2 V.	High	Runtime	No
<b>Battery Undetected</b>	Battery undetected	Medium	Runtime	No
<b>Battery in Use</b>	AC power fail	Low	Runtime	No
<b>Power Board High Temp</b>	Power board temperature is greater than 95° C	High	Runtime	No
<b>Heating Module Failure</b>	1. Both resistance temperatures are greater than 105° C or less than 0° C for 20 seconds. 2. One of the resistance temperatures is greater than 110° C for 15 seconds.	Low	Runtime	No
<b>Breathing Circuit Not Mounted</b>	Breathing Circuit is not mounted.	High	Runtime	No

**TABLE 6-6** Power Board Runtime Alarm Messages

**NOTE:** If the power board loses communication with the CPU board for 10 seconds, the alarm buzzer is turned on.

**NOTE:** If the system restarts accidentally, the alarm buzzer will sound for 10 seconds to show notification.

## 6.6.2.4 Flow Control System Runtime Alarm

MESSAGE	CAUSE	ALARM PRIORITY	MACHINE MODE WHEN CHECKED	DISABLE IN STANDBY MODE
<b>Electronic Flow Control Error</b>	CPU AVDD Power Voltage too low	Medium	Runtime	No
	CPU AVDD Power Voltage too high	Medium	Runtime	No
	CPU DVDD Power Voltage too low	Medium	Runtime	No
	CPU DVDD Power Voltage too high	Medium	Runtime	No
	CPU DVCC Power Voltage too low	Medium	Runtime	No
	CPU DVCC Power Voltage too high	Medium	Runtime	No
	FPGA VPP Voltage too low	Medium	Runtime	No
	FPGA VPP Voltage too high	Medium	Runtime	No
	FPGA 3.3 V Voltage too low	Medium	Runtime	No
	FPGA 3.3 V Voltage too high	Medium	Runtime	No
	FPGA 1.2 V Voltage too low	Medium	Runtime	No
	FPGA 1.2 V Voltage too high	Medium	Runtime	No
	FPGA DVCC Voltage too low	Medium	Runtime	No
	FPGA DVCC Voltage too high	Medium	Runtime	No
	FPGA AVCC Voltage too low	Medium	Runtime	No
	FPGA AVCC Voltage too high	Medium	Runtime	No
	3-Way Valve Error	Medium	Runtime	No
	O <sub>2</sub> Branch Flow Sensor Error	Medium	Runtime	No
	Air Branch Flow Sensor Error	Medium	Runtime	No
	N <sub>2</sub> O Branch Flow Sensor Error	Medium	Runtime	No
	O <sub>2</sub> Branch Flow not Achieved	Medium	Runtime	No
	Balance Gas Branch Flow not Achieved	Medium	Runtime	No
	Balance Gas Branch Temp. High	Medium	Runtime	No
O <sub>2</sub> Branch Temp. High	Medium	Runtime	No	
FPGA Error	Medium	Runtime	No	
<b>O<sub>2</sub> Branch Flow not Achieved</b>	O <sub>2</sub> branch measured flow is over the O <sub>2</sub> branch target flow±max (10 %, 200 mlpm)	Low	Runtime	N/A *
<b>Balance Gas Branch Flow not Achieved</b>	Balance branch measured flow is over the balance branch target flow±max (10 %, 200 mlpm)	Low	Runtime	N/A *

\* N/A - Not Applicable. This alarm message does not exist within this mode and therefore cannot be disabled or enabled.

**TABLE 6-7** Electronic Flow Control System Runtime Alarm Messages

MESSAGE	CAUSE	ALARM PRIORITY	MACHINE MODE WHEN CHECKED	DISABLE IN STANDBY MODE
<b>No Fresh Gas</b>	The flows of O <sub>2</sub> and balance gas are less than 0.05 LPM for continuous 5 s.	Medium	Runtime	No
<b>Backup Flow Control Deployment Failure</b>	Solenoid Actuator Error	High	Runtime	No
<b>Backup Flow Control Retraction Failure</b>	Stepper Motor Error	Medium	Runtime	No
<b>Air Supply Failure</b>	Air Supply Pressure Low	Medium	Runtime	No
<b>N<sub>2</sub>O Supply Failure</b>	N <sub>2</sub> O Supply Pressure Low	Medium	Runtime	No
<b>Backup Flow Control Valves Open</b>	Needle Valve is not closed BFCS is not closed	Medium	Runtime	No
<b>Backup Flow Control is enabled</b>	Backup Flow Control is enabled	Low	Runtime	No
<b>Flowmeter Comm Stop</b>	Lost communication with cpu board for 10 seconds. The Flowmeter Comm Stop will be detected by both Main board CPU and Flowmeter CPU.	Medium	Runtime	No
<b>Backup Flow Control Error</b>	BFCS Deployment Position sensor Error BFCS Retraction Position sensor Error LED Power Voltage too low LED Power Voltage too high	Medium	Runtime	No

\* N/A - Not Applicable. This alarm message does not exist within this mode and therefore cannot be disabled or enabled.

**TABLE 6-7** Electronic Flow Control System Runtime Alarm Messages

### 6.6.2.5 Ventilator Control Board Runtime Alarm

MESSAGE	CAUSE	ALARM PRIORITY	MACHINE MODE WHEN CHECKED	DISABLE IN STANDBY MODE
<b>Aux Control Module Comm Stop</b>	Lost communication with CPU board for 10 seconds.	High	Runtime	No
<b>Ventilator Voltage Error</b>	5 V or 12 V voltage error	High	Runtime	No

\* N/A - Not Applicable. This alarm message does not exist within this mode and therefore cannot be disabled or enabled.

**TABLE 6-8** Ventilator Control Board Runtime Alarm Messages

MESSAGE	CAUSE	ALARM PRIORITY	MACHINE MODE WHEN CHECKED	DISABLE IN STANDBY MODE
<b>PEEP Valve Failure</b>	1. PEEP valve voltage error 2. PEEP valve pressure error	Medium	Runtime	No
<b>Insp Valve Failure</b>	1. Inspiratory valve voltage error 2. Inspiratory valve flow error	Medium	Runtime	No
<b>Safety Valve Failure</b>	PEEP safety valve voltage error	Medium	Runtime	No
<b>Flow Sensor Failure</b>	1. Inspiratory flow is out of range. 2. Expiratory flow is out of range.	Low	Runtime	No
<b>Check Flow Sensors</b>	1. Inspiratory reverse flow 2. Expiratory reverse flow	High	Runtime	N/A *
<b>Pinsp Not Achieved</b>	Pinsp does not reach the Pinsp setting in pressure mode.	Low	Runtime	N/A *
<b>Vt Not Achieved</b>	Vt does not reach the Vt setting in volume mode.	Low	Runtime	N/A *
<b>Automatic Ventilation Disabled</b>	The machine is in the automatic ventilation disabled state.	Low	Runtime	No
<b>Auto Ventilation Disabled-Leak Test Failed</b>	Automatic Circuit Leak Test failed, and the result is "Manual Only".	Low	Runtime	No
<b>ACGO 3-way Valve Failure</b>	ACGO 3-way Valve status is error.	Medium	Runtime	No
<b>Auto Ventilation is Non-Functional</b>	System is in the Auto Ventilation Non-functional state.	High	Runtime	N/A *
<b>ACGO Failure</b>	ACGO switch status error.	Low	Runtime	No
<b>Electronic ACGO Undetected</b>	Electronic ACGO configuration incompatible with hardware.	Low	Runtime	No
<b>Patient Circuit Leak</b>	1. Ppeak is less than 2cmH <sub>2</sub> O for continuously 30s during mechanical ventilation. 2. Patient is not connected.	Medium	Runtime	N/A*
<b>CO<sub>2</sub> Absorber Canister Not Locked</b>	CO <sub>2</sub> Canister is not mounted.	High	Runtime	No
<b>Ventilator Comm Stop</b>	Lost communication with the CPU board for 10 seconds.	High	Runtime	No
<b>Drive Gas Pressure Low</b>	Drive Gas Pressure is low.	High	Runtime	No

\* N/A - Not Applicable. This alarm message does not exist within this mode and therefore cannot be disabled or enabled.

**TABLE 6-8** Ventilator Control Board Runtime Alarm Messages



MESSAGE	CAUSE	ALARM PRIORITY	MACHINE MODE WHEN CHECKED	DISABLE IN STANDBY MODE
<b>O<sub>2</sub> Supply Failure</b>	O <sub>2</sub> Supply Failure	High	Runtime	No
<b>Fresh Gas Flow Too High</b>	In VCV and SIMV-VC modes, the fresh gas flow is greater than or equal to the desired flow.	Low	Runtime	N/A *

\* N/A - Not Applicable. This alarm message does not exist within this mode and therefore cannot be disabled or enabled.

**TABLE 6-8** Ventilator Control Board Runtime Alarm Messages

### 6.6.2.6 Anesthetic Gas (AG) Module Alarm Messages

MESSAGE	CAUSE	ALARM PRIORITY	MACHINE MODE WHEN CHECKED	DISABLE WHEN EXTERNAL AG IS IN STANDBY MODE
<b>AG Hardware Error</b>	AG module Hardware Error.	Medium	Runtime	Yes
<b>O<sub>2</sub> Sensor Error</b>	Paramagnetic O <sub>2</sub> sensor error.	Medium	Runtime	Yes
<b>External AG Self Test Error</b>	Module fault or communication failure between the module and anesthesia system.	Low	Runtime	Yes
<b>AG Hardware Malfunction</b>	AG module hardware malfunction. The AG module enters Standby and measurement stops.	High	Runtime	Yes
<b>AG Init Error</b>	The AG module was installed improperly or malfunctioned.	High	Runtime	Yes
<b>AG No Watertrap</b>	The AG module watertrap was installed improperly or not installed.	Low	Runtime	Yes
<b>AG Watertrap Type Wrong</b>	When the patient type is infant, but the watertrap type is adult/pediatric, this alarm will be triggered.	Low	Runtime	Yes
<b>AG Change Watertrap</b>	When the actual flow is less than 75 % of the set flow, the alarm indicates that the watertrap is gradually occluded and it is necessary to replace the water trap.	Medium	Runtime	Yes
<b>AG Comm Stop</b>	AG module malfunction or communication failure.	High	Runtime	No

**TABLE 6-9** AG Module Alarm Messages

MESSAGE	CAUSE	ALARM PRIORITY	MACHINE MODE WHEN CHECKED	DISABLE WHEN EXTERNAL AG IS IN STANDBY MODE
<b>AG Airway Occluded</b>	Pump rate is lower than 20 ml/min for 1 second.	High	Runtime	Yes
<b>AG Zero Failed</b>	Gas measurements may have bad accuracy during zeroing.	Low	Runtime	Yes
<b>Mixed Agent and MAC &lt; 3</b>	MAC < 3	Low	Runtime	Yes
<b>Mixed Agent and MAC ≥ 3</b>	MAC ≥ 3	Medium	Runtime	Yes
<b>Mixed Agent</b>	Two anesthetic agents are detected but MAC is an invalid value.	Medium	Runtime	Yes
<b>External AG Module Disconnected</b>	The external AG module has been disconnected and no O <sub>2</sub> sensor is connected.	High	Runtime	No
<b>Incompatible AG Software Version</b>	The AG Version Limit is On, and the AG module is loaded while the AG software version is lower than 1.7.3.0.	High	Runtime	No
<b>CO<sub>2</sub> Over Range</b>	The monitoring value exceeds the measurable range.	Low	Runtime	Yes
<b>N<sub>2</sub>O Over Range</b>				
<b>Hal Over Range</b>				
<b>Enf Over Range</b>				
<b>Iso Over Range</b>				
<b>Sev Over Range</b>				
<b>Des Over Range</b>				
<b>O<sub>2</sub> Over Range</b>				
<b>Rate Over Range</b>				

**TABLE 6-9** AG Module Alarm Messages

MESSAGE	CAUSE	ALARM PRIORITY	MACHINE MODE WHEN CHECKED	DISABLE WHEN EXTERNAL AG IS IN STANDBY MODE
<b>Internal AG Error 01</b>	Internal AG Hardware Error	Low	Runtime	Yes
<b>Internal AG Error 02</b>	Internal AG Selftest Error			
<b>Internal AG Error 03</b>	Internal AG Hardware Malfunction			
<b>Internal AG Error 04</b>	Internal AG Init Error			
<b>Internal AG Error 05</b>	Internal AG Comm Stop			
<b>Internal AG Error 07</b>	Internal AG Zero Failed			
<b>Internal AG Error 09</b>	Internal AG No Watertrap			
<b>Internal AG Error 10</b>	Internal AG Airway Occluded			
<b>Internal AG Error 11</b>	Internal AG Change Watertrap			

**TABLE 6-9** AG Module Alarm Messages

## 6.6.3 Prompt Messages

### 6.6.3.1 Prompt Messages Displayed in Alarm Area

MESSAGE	REMARK
<b>Pressure, Volume and Apnea Alarms are OFF</b>	This message displays when the <b>Alarms</b> button in the Manual mode tab is set to <b>Off</b> .
<b>CO<sub>2</sub> and CO<sub>2</sub> Apnea Alarms are OFF</b>	This message appears when the <b>CO<sub>2</sub> Alarms</b> button in the <b>Manual</b> mode tab is set to <b>Off</b> .
<b>Load Configuration Failure</b>	This message displays when the download or latest configuration update failed.
<b>DEMO Mode - Not for Clinical Use</b>	This message displays when the system is set to demo mode from the <b>Service</b> tab.
<b>Service Mode - Not for Clinical Use</b>	This message displays when the machine is worked in Service mode.
<b>Apnea Ventilation</b>	This message displays when apnea ventilation is triggered in PS mode.
<b>Auto-zero in process</b>	This message displays when auto-zeroing of the pressure sensors is in process.
<b>New functions activated, please restart!</b>	This message displays when activation successfully completed.
<b>Restart to Activate New Flowmeter Standard</b>	This message displays when flowmeter standard is changed.
<b>Calibrate internal AG</b>	This message displays when the external AG module hasn't calibrated successfully for 365 days.
<b>Calibrate external AG</b>	This message displays when the external AG module hasn't calibrated successfully for 365 days.
<b>Could not locate time server</b>	This message displays when the Interval of SNTP Protocol is not Off and the time server is unavailable for 5 intervals.
<b>External AG Loaded Successfully.</b>	External AG loaded successfully.
<b>External AG Unloaded Successfully.</b>	External AG unloaded successfully.
<b>External AG Startup</b>	External AG module is starting up.
<b>External AG Warmup</b>	External AG module is warming up.
<b>External AG Zeroing</b>	The external AG module is being zeroed.
<b>Leak Test Not Performed</b>	This message displays when either the automatic leak test or manual leak test was skipped from startup, or when the last time that the leak test was performed was more than 24 hours ago.
<b>Ventilation and Fresh Gas Flow Paused</b>	This message displays when the <b>Flow Pause</b> is active.
<b>All Physiological Alarms are OFF</b>	This message displays when the <b>Flow Pause</b> is active.

**TABLE 6-10** Prompt Messages Display in Alarm Area

### 6.6.3.2 Prompt Messages Displayed in Pop-up Area

MESSAGE	REMARK
<b>Patient Size can only be changed in Manual Mode or in Standby</b>	This message displays when the <b>Patient Size</b> selection is pressed while the system is in Automatic Ventilation mode.
<b>Vent modes can only be changed using "Set Mode" button below</b>	This message displays when the <b>Current Mode</b> area is pressed.
<b>Out of Range</b>	This message displays when the entered value is outside the allowable range.
<b>Invalid Password</b>	This message displays when the entered password is wrong.
<b>Saving User Configuration has failed.</b>	This message displays when the <b>Saving User Configuration</b> process has failed.
<b>New password input is inconsistent.</b>	This message displays when the new password and the confirmed new password do not match.
<b>Fresh gas flow detected! Adjust all flowmeters to zero</b>	This message displays in the first "Manual Circuit Leak Test" or "Automatic Circuit Leak Test & Compliance Test" screen when fresh gas flow is detected.
<b>Access to System settings only available in Standby</b>	This message displays when the current mode is in non-standby and the user tries to enter the <b>Setup &gt; System</b> menu.
<b>Set Auto/Manual switch to manual position before starting case</b>	When Auto/Manual switch is in Auto position and system is in Standby, this message displays in the following cases: 1. turning on fresh gas; 2. touching the Waveforms/Spirometry screen.
<b>Set Auto/Manual switch to Auto position and adjust all flowmeters to zero.</b>	This message displays in the first "Automatic Circuit Leak Test & Compliance Test" screen when pressing the disabled Continue button.
<b>Set Auto/Manual switch to Manual position and adjust all flowmeters to zero.</b>	This message displays in the first "Manual Circuit Leak Test" screen when pressing the disabled Continue button.
<b>Invalid Age! Please check DOB or current system time.</b>	This message displays when the patient calculation age is greater than 150 or less than 0 years.
<b>Can not end case while fresh gas flow is detected!</b>	This message displays when user tries to end the case by pressing the disabled <b>End Case</b> button while fresh gas is on, <b>Auto/Manual</b> switch is in <b>Manual</b> position, and the system is not in Standby.
<b>Can only End Case in Manual Mode!</b>	This message displays when the <b>Auto/Manual</b> switch is in <b>Auto</b> position and the system is not in Standby, then, user presses the disabled <b>End Case</b> button.
<b>Balance gas not detected</b>	This message displays when the balance gas is not detected and the user tries to set balance gas greater than 0.00 L/min (EFCS is configured).
<b>N<sub>2</sub>O not detected</b>	This message displays when the N <sub>2</sub> O is not detected and user sets balance gas to N <sub>2</sub> O (EFCS is configured).
<b>Air not detected</b>	This message displays when the air is not detected and user sets balance gas to Air (EFCS is configured).
<b>Set Auto/Manual switch to Manual position.</b>	This message displays in the first <b>Manual Circuit Leak Test</b> screen when pressing the disabled <b>Continue</b> button if EFCS is configured.
<b>Set Auto/Manual switch to Auto position.</b>	This message displays in the first <b>Automatic Circuit Leak Test &amp; Compliance Test</b> screen when pressing the disabled Continue button if EFCS is configured.

**TABLE 6-11** Prompt Messages Displayed in Pop-up Area

MESSAGE	REMARK
<b>Close manual valves prior to disabling Backup Flow Control</b>	This message displays when the needle valve is not closed and the user presses the <b>Yes</b> button to disable Backup Flow Control (if BFCS is active).
<b>Contact service to disable Backup Flow Control</b>	This message displays when the user presses the disabled <b>Disable Backup Flow Control</b> button (if BFCS is active).
<b>Close manual valves prior to "End Case"</b>	This message displays when the needle valve is not closed and the user presses the <b>End Case</b> button (if BFCS is active).
<b>Cannot set Fresh Gas Flow in Monitor mode.</b>	This message displays when the user presses the fresh gas flow area or adjusts encoder knob in <b>Monitor</b> mode.

**TABLE 6-11** Prompt Messages Displayed in Pop-up Area

# **Maintenance**

---

Theory of Operation .....	7-3
Block Diagram.....	7-3
Maintenance Schedule .....	7-4
Breathing System Maintenance.....	7-4
Flow Sensor Calibration .....	7-5
Water Build-up in the Flow Sensor .....	7-6
Water Build-up in the Flow Sensor .....	7-6
AGSS Transfer Tube Maintenance.....	7-7
Electrical Safety Inspection.....	7-7
Cleaning and Disinfection.....	7-8
Regular Maintenance .....	7-26

- 
- WARNING:** Do not use a malfunctioning A7 Anesthesia System. Have all repairs and service done by an authorized service representative.
- WARNING:** Use a cleaning and disinfection schedule that conforms to your institution's disinfection and risk-management policies.
- Refer to the material safety data sheet as applicable.
  - Refer to the operation and maintenance manuals of all disinfection equipment.
  - Do not inhale fumes that may result from any disinfection process.
- WARNING:** Do not use talc, zinc stearate, calcium carbonate, corn starch, or similar material to prevent sticking of the bellows, as these materials may enter the patient's lungs or airway, causing irritation or injury.
- WARNING:** Only use lubricants approved for anesthesia or O<sub>2</sub> equipment.
- WARNING:** Do not use lubricants that contain oil or grease. They can burn or explode in the presence of high O<sub>2</sub> concentrations.
- WARNING:** Obey infection control and safety procedures. Utilized equipment may contain blood and body fluids.
- WARNING:** Movable parts and removable components may present a pinch or a crush hazard. Use care when moving or replacing system parts and components.
- WARNING:** Before using the A7 System (after cleaning or disinfecting), power up the system and follow the on-screen prompts to perform the leak test and the compliance test. See section 4.5 (page 4-8) "Leak and Compliance Tests".
- CAUTION:** To prevent system damage:
- Refer to the literature supplied by the manufacturer of the cleaning agent.
  - Never use organic, halogenated or petroleum-based solvents, anesthetics, glass cleaning agents, acetone or other irritant agents.
  - Never use abrasive agents (i.e. steel wool or silver polish) to clean components.
  - Keep all liquids away from electronic components.
  - Prevent liquid from entering the equipment.
  - All cleaning solutions used must have a pH between 7.0 and 10.5.
- CAUTION:** Do not autoclave the following components: Paw gauge, flow sensor, and bellows. These components cannot withstand immersion or the heat and pressure of autoclaving.
- NOTE:** No repair should ever be attempted by anyone not having experience in the repair of devices of this nature. Replace damaged parts with components manufactured or sold by Mindray. Then test the unit to ensure that it complies with the manufacturer's published specifications.



## 7.1 Theory of Operation

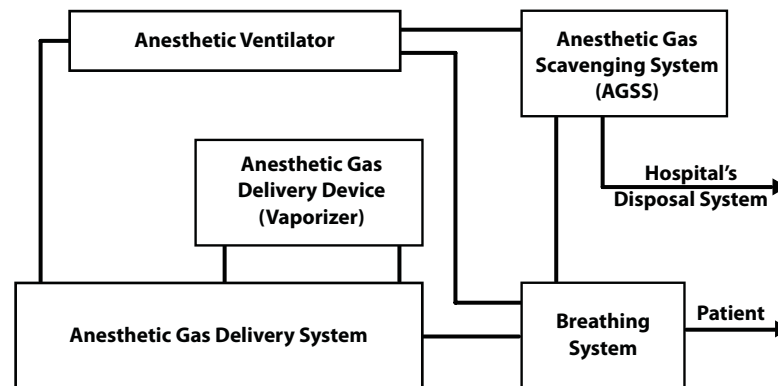
The A7 System is a pneumatically-driven and electronically-controlled anesthesia machine. Three types of supply gases are available: N<sub>2</sub>O, O<sub>2</sub>, and Air. The user adjusts supply gas flows through the flowmeters. The mixed gas outputted from the flowmeters is further mixed with the anesthetic agent inside the anesthetic vaporizer to form the fresh gas.

During the inspiratory phase, the microprocessor-controlled inspiratory valve produces the preset drive gas inspiratory flow and the expiratory valve closes. The drive gas enters the bellows dome in the patient circuit and depresses the bellows inside the dome to move downward. This forces the gas inside the bellows to enter the patient's lungs until the end of the inspiratory phase.

During the expiratory phase, the inspiratory valve closes and the expiratory valve opens. The patient can expire freely. The patient's expired gas, mixed with the fresh gas, enters and lifts the bellows inside the dome. The drive gas outside the bellows is scavenged to the Anesthetic Gas Scavenging System (AGSS) until the end of the expiratory phase.

During ventilation, the ventilator performs real-time monitoring over airway pressure and flow. If the airway pressure or minute volume is outside the user-preset alarm limits, an audible and visible alarm occurs. When the airway pressure is higher than the limit value determined by the PEAK high alarm limit, the ventilator enters the expiratory phase automatically to avoid causing injury to the patient. Additionally, the ventilator has a built-in pressure safety valve that opens at an approximate pressure of 110 cmH<sub>2</sub>O (11 kPa).

## 7.2 Block Diagram



**FIGURE 7-1** Block Diagram of A7 System

## 7.3 Maintenance Schedule

The schedules listed in TABLE 7-1 are the minimum frequency based on 2000 hours of usage per year. Service the equipment more frequently if used more than this yearly usage. Maintenance should be performed by a trained technician.

**NOTE:**        **During cleaning and setup, inspect the parts and seals for damage. Replace or repair as necessary.**

MINIMUM FREQUENCY	MAINTENANCE
Daily	Clean the external surfaces.
Annually	Perform periodic maintenance by a trained technician. Contact Mindray Technical Support for details.
Every three years	Perform periodic maintenance by a trained technician. Contact Mindray Technical Support for details.
As necessary	<ul style="list-style-type: none"> <li>• Before installing the cylinder, use a new cylinder gasket on the cylinder yoke.</li> <li>• Empty the water trap if there is water buildup.</li> <li>• Replace the soda lime in the canister if soda lime color change is detected. Follow the manufacturer's instructions.</li> <li>• Replace the flow sensor if the seal for the flow sensor is damaged, the membrane inside the flow sensor is cracked or distorted, or the flow sensor is cracked or distorted.</li> <li>• Calibrate the flow sensor after re-installing the cleaned or disinfected flow sensor, after replacing with a new flow sensor, or when tidal volume measurement is inaccurate.</li> <li>• Replace the waste gas transfer tube if it is damaged.</li> <li>• Inspect the O<sub>2</sub> flush button for normal movement. If not, refer to the service manual for the disassembling and cleaning.</li> </ul>

**TABLE 7-1** Maintenance Schedule

## 7.4 Breathing System Maintenance

When cleaning the breathing system, replace any parts that are visibly cracked, chipped, distorted or worn. For details, refer to "Inspect the System" on page 4-3 and "Cleaning and Disinfection" on page 7-8.

## 7.5 Flow Sensor Calibration

**WARNING:** Do not perform calibration while the unit is connected to a patient.

**NOTE:** During calibration, do not operate the pneumatic parts. Do not move or press the breathing tubes.

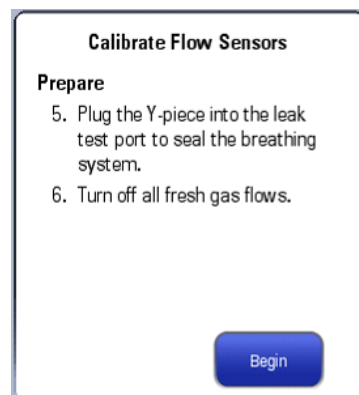
**NOTE:** Calibrate the flow sensor after re-installing the cleaned or disinfected flow sensor, after replacing with a new flow sensor, or when tidal volume measurement is inaccurate.

The flow sensor must be calibrated whenever the flow volume is out of specification or after changing the flow sensor.

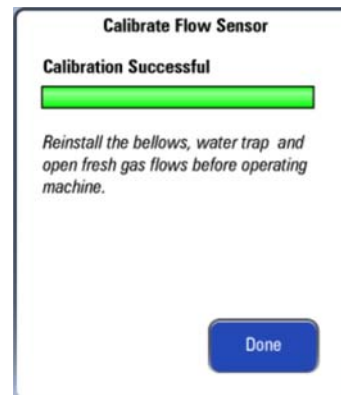
To calibrate the flow sensor:

1. Ensure that the supply gas pressure is normal.
2. Turn off all fresh gas inputs.
3. Set the **Auto/Manual** ventilation switch to **Auto**.
4. Remove the bellows and reinstall the bellows housing.
5. Plug the Y-piece of the breathing circuit into the leak test port to close the breathing system.
6. Remove the water trap.
7. Ensure that the system is in **Standby** mode. If not, select the **End Case** button in the **Manual** tab and follow the screen prompts to end the case and enter **Standby** mode.
8. Select **Setup > General > Calibrate Flow Sensors**.
9. Follow the on-screen prompts and select the **Begin** button to start to calibrate the flow sensor (see FIGURE 7-2). The calibration process takes several minutes. The system displays the results of the calibration status when the process is completed.
10. Reinstall the bellows and water trap.
11. Select **Done** to close the **Calibration** window (see FIGURE 7-3).
12. Select the **Accept** or **Cancel** softkey to close the **Setup** window.

**NOTE:** In case of repeated calibration failure, contact Mindray Technical Support.



**FIGURE 7-2** Flow Sensor Calibration Begin



**FIGURE 7-3** Flow Sensor Calibration Successful

---

## 7.6 Water Build-up in the Flow Sensor

### 7.6.1 Prevent Water Build-up

Water comes from the condensation of exhaled gas and a chemical reaction between CO<sub>2</sub> and the soda lime in the CO<sub>2</sub> absorbent canister. At lower fresh gas flows more water builds up because of the following:

- Less gas in the breathing system is removed through AGSS and gets replaced with fresh gas.
- More CO<sub>2</sub> stays in the CO<sub>2</sub> absorbent canister to react and produce water.
- More moist, exhaled gas stays in the breathing system and CO<sub>2</sub> absorbent canister to produce condensed water.

Check the inspiratory and expiratory flow sensors when abnormal flow waveform or unstable tidal volume fluctuation is detected. Check the sensor for water. If there is water build-up, clear it immediately before use.

**To prevent water build-up:**

- Use a filter between the flow sensor and the patient to limit water condensation in the flow sensor.
- Check the water trap for water before using the A7 Anesthesia System. If there is water build-up, clear it immediately.

### 7.6.2 Clear Water Build-up

Water build-up inside the flow sensor results in inaccurate measured value of tidal volume. If there is water built up inside the flow sensor, remove the sensor and clear the water, then reinstall the sensor for use.

**WARNING:** Check water build-up inside the flow sensor before every system use. Accumulated water in the flow sensor causes erroneous readings.

**WARNING:** Ensure that all breathing system parts are completely dried after the breathing system is cleaned and disinfected.

## 7.7 AGSS Transfer Tube Maintenance

Check the tube of the AGSS transfer system. Replace it if it is damaged.

## 7.8 Electrical Safety Inspection

Refer to the Service Manual for the details.

**NOTE:** Perform electrical safety inspection after servicing or routine maintenance. Before the electrical safety inspection, make sure all the covers, panels, and screws are correctly installed.

**NOTE:** Perform the electrical safety inspection once a year.

## 7.9 Cleaning and Disinfection

**CAUTION:** Before using the A7 System (after cleaning or disinfecting), power up the system and follow the on-screen prompts to perform the leak test and the compliance test. See section 4.5 (page 4-8) "Leak and Compliance Tests".

**CAUTION:** To prevent system damage:

- Refer to the literature supplied by the manufacturer of the cleaning agent.
- Never use organic, halogenated or petroleum-based solvents, anesthetics, glass cleaning agents, acetone or other irritant agents.
- Never use abrasive agents (i.e. steel wool or silver polish) to clean components.
- Keep all liquids away from electronic components.
- Prevent liquid from entering the equipment.
- All cleaning solutions used must have a pH between 7.0 and 10.5.
- Do not use Cavacide: Cavacide is known to cause degradation of plastic polymers.
- Do not use Oxicide: May cause discoloration of device hardware.

### 7.9.1 General Guidelines

Follow all WARNINGS and CAUTIONS listed at the beginning of this chapter. Prior to use, refer to the facility's infection control policy to determine the frequency and level at which cleaning and disinfection should be performed. If disinfection is required, all components must first be cleaned and dried as described in the following sub-sections. For additional information about infection control practices, refer to the *APIC Guidelines for Selection and Use of Disinfectants*, published in the American Journal of Infection Control, Vol. 24, No. 4, August 1996.

For additional information about infection control, refer to the ASA's Recommendations for Infection Control for the Practice of Anesthesiology, second edition. For additional information on reprocessing medical devices, refer to AAMI TIR 30:2003, A compendium of process, materials, test methods, and acceptance criteria for cleaning reusable medical devices.

### 7.9.2 Cleaning and Disinfecting Agents / Autoclaving

Clean and disinfect the A7 before its first use, then daily and as often as needed. (see TABLE 7-1, "Maintenance Schedule," on page 7-4.)

TABLE 7-2 to TABLE 7-4 list the allowable cleaning and disinfecting agents and autoclaving process for the A7 Anesthesia System.

#### **CLEANING AGENT**

---

Water

---

Green soap tincture

---

**TABLE 7-2** Cleaning Agents

**DISINFECTING AGENT**

Isopropyl alcohol (70 %)

Sodium hypochlorite solution, 10 % available chlorine

Super Sani-Cloth (0.5 % Quaternary ammonium chloride and 55 % Isopropyl alcohol)

Cidex (Only for bellows, Inspiratory Pressure Gauge and Ins/Exp Flow sensors)

ALPET D2 Surface sanitizer wipes

Viraguard surface disinfectant towelette

**TABLE 7-3** Disinfecting Agents**AUTOCLAVING**

Autoclaving process \*

- \* *All breathing system components are autoclavable except the PAW gauge, flow sensor, and bellows. The components can be autoclaved up to a maximum temperature of 134 °C (273 °F). The suction tubes of the negative pressure suction device are not autoclavable.*

**TABLE 7-4** Autoclaving

### 7.9.3 External Surfaces

Use a soft cloth with an approved cleaning agent (see section 7.9.2 (page 7-8) "Cleaning and Disinfecting Agents / Autoclaving") to clean all outer surfaces, hoses, and cables.

### 7.9.4 Bellows Assembly



**FIGURE 7-4** Bellows Assembly

Read all content in this section before disassembling, cleaning, disinfecting, and re-assembling the bellows to avoid equipment malfunction and patient injury.

1. The bellows dome is a transparent cover with graduation marks from 300 to 1500 ml. Remove the bellows dome by turning it counterclockwise and lifting it away from the breathing system. (see FIGURE 7-5)



**FIGURE 7-5** Removing the Bellows Dome



2. Detach the bellows from the base plate (see FIGURE 7-6).



**FIGURE 7-6** Detaching the Bellows

3. Detach the top plate from the bellows (see FIGURE 7-7).



**FIGURE 7-7** Detaching the Bellows Top Plate

4. Remove the bellows adapter ring from inside the bellows (see FIGURE 7-8). Note the orientation of the bellows adapter ring as it is being removed to ensure that it is properly inserted during reassembly. (If the ring contains grooves, the ring should be oriented so that the grooves are facing downward in the final reassembly.)



Grooves on adapter ring face downward.

**FIGURE 7-8** Removing the Bellows Adapter Ring

5. Remove the bellows dome O-ring (see FIGURE 7-9).



**FIGURE 7-9** Removing the Bellows Dome O-ring

## 6. Cleaning

- a. To prevent damage, wash each component gently using a recommended cleaning agent (see TABLE 7-2 on page 7-8). Ensure that all bellows surfaces are cleaned. Do not autoclave the bellows.
- b. Rinse with clean, hot water, and allow to dry.

**NOTE:** Dry the bellows by allowing it to hang so that it is fully expanded. This will facilitate thorough drying and prevent it from sticking to itself.

**CAUTION:** Do not autoclave the following components: Paw gauge, flow sensor, and bellows. These components cannot withstand immersion or the heat and pressure of autoclaving.

**CAUTION:** If moisture remains in the bellows after cleaning, the bellows surface folds may become tacky and prevent the bellows from properly expanding. Ensure all moisture is removed from the bellows after cleaning.

- c. After all bellows components are completely dry, inspect them for damage before disinfection or re-assembly and functional testing.
- d. If disinfecting the bellows components, continue with step 7, otherwise skip to step 8.

## 7. Disinfection

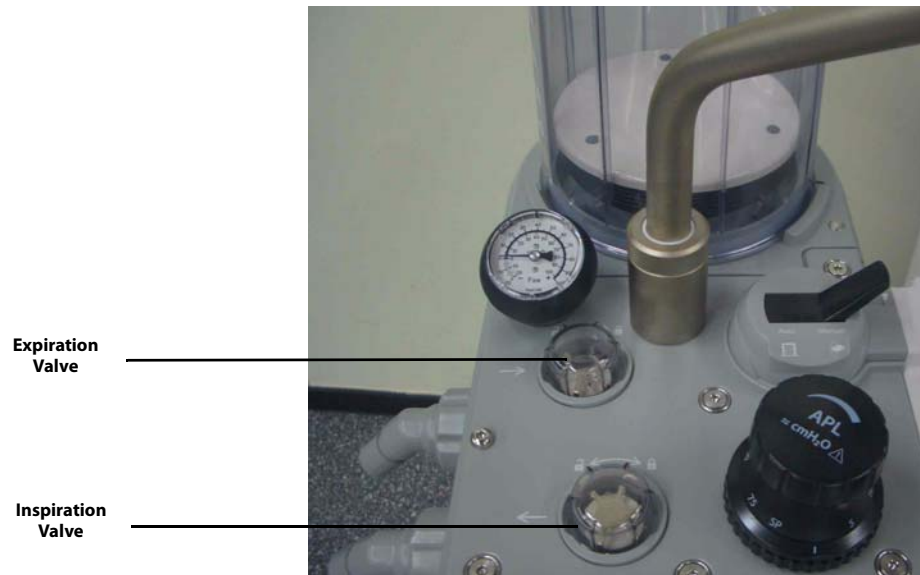
**NOTE:** Ensure that all bellows components have been cleaned as described in step 6 before disinfecting.

Use an approved disinfecting agent (see TABLE 7-3 on page 7-9) for all bellows components while adhering to facility policies and procedures.

- 8. Connect the bellows to the breathing system by reassembling all components in the reverse order. Prior to use after cleaning or disinfecting, power up the system and follow the on-screen prompts to perform the leak test and the compliance test (see section 4.5 (page 4-8) "Leak and Compliance Tests").

## 7.9.5 Inspiration and Expiration Valves

The following procedure is written generically for a single, unspecified valve. It should be performed on both the inspiration and expiration valves.



**FIGURE 7-10** Location of Expiration and Inspiration Valves

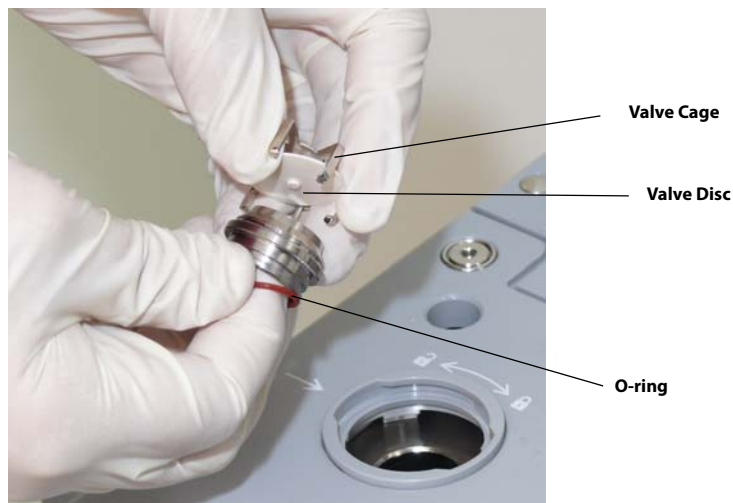
1. Remove the valve dome (see FIGURE 7-11), turning it counterclockwise.



**FIGURE 7-11** Valve Dome Removal

**CAUTION:** The valve disc in each of the inhalation and exhalation valve assemblies on the breathing system is fragile and must be handled with care while removing the valve cage from the valve assembly.

2. Remove the valve cage (see FIGURE 7-12). The six prongs of the valve cage have tabs that secure cage onto the valve assembly. While noting the previous **CAUTION**, use two hands to remove the valve cage by gently manipulating the prongs to release the tabs. As the valve cage is lifted away from the assembly, ensure that the valve disc does not fall out.
3. Remove the valve disc from the valve cage (see FIGURE 7-12).
4. Remove the O-ring from the bottom of the valve assembly (see FIGURE 7-12).



**FIGURE 7-12** Valve Cage Removal

**CAUTION:** The valve disc in each of the inhalation and exhalation valve assemblies on the breathing system is fragile and must be handled with care while removing the valve cage from the valve assembly.

**5. Cleaning**

- a.** Wash each component using a recommended cleaning agent (see TABLE 7-2 on page 7-8).
- b.** Rinse with clean, hot water, and allow to dry.
- c.** After all components are completely dry, verify that the valve disc and the prongs of the valve cage are undamaged before disinfection or re-assembly and functional testing.
- d.** If disinfecting the valve components, continue with step 6, otherwise skip to step 7.

**6. Disinfection**

**NOTE:**        **Ensure that all valve components have been cleaned as described in step 5 before disinfecting.**

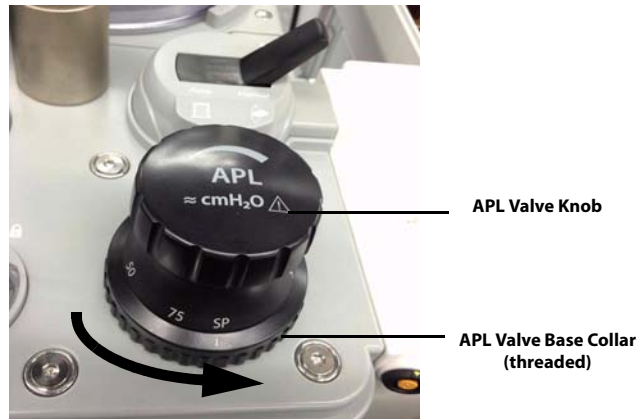
Use an approved disinfecting agent (see TABLE 7-3 on page 7-9 and TABLE 7-4 on page 7-9) for all valve components while adhering to facility policies and procedures.

**7. Reassembly**

Reassemble the valve components in the reverse order, noting any previously stated **CAUTION**. Prior to use after cleaning or disinfecting, power up the system and follow the on-screen prompts to perform the leak test and the compliance test (see section 4.5 (page 4-8) "Leak and Compliance Tests").

## 7.9.6 APL Valve

1. The APL valve is a component that is plugged into position and secured by a threaded base collar. Loosen the base collar of the APL valve by turning the collar (not the valve knob) counterclockwise until it is no longer threaded (see FIGURE 7-13). Then, firmly pull the APL valve upward to remove.



**FIGURE 7-13** APL Valve Removal

### 2. Cleaning

- a. Clean the APL valve with a soft, lint-free cloth and a recommended cleaning agent (see TABLE 7-2 on page 7-8). Allow it to dry thoroughly.
- b. If disinfecting the APL valve, continue with step 3, otherwise skip to step 4.

### 3. Disinfection

**NOTE:** Ensure that the APL valve has been cleaned as described in step 2 before disinfecting.

Use an approved disinfecting agent ( see TABLE 7-3 on page 7-9 and TABLE 7-4 on page 7-9) for the APL valve while adhering to facility policies and procedures.

4. Reassemble the APL valve by turning its base collar clockwise until it is securely tightened. Prior to use after cleaning or disinfecting, power up the system and follow the on-screen prompts to perform the leak test and the compliance test. see section 4.5 (page 4-8) "Leak and Compliance Tests".

## 7.9.7 PAW Gauge

1. The PAW gauge is a component that is plugged into position for use. It is not necessary to remove this component to clean it. However, if removal is desired, simply hold it and lift it straight up from the breathing system block (see FIGURE 7-14).

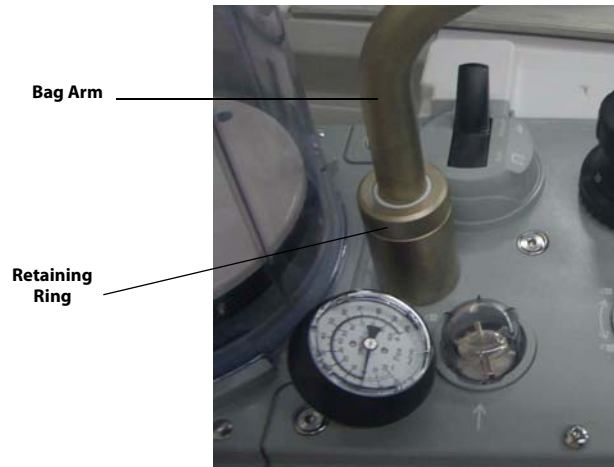


**FIGURE 7-14** PAW Gauge Removal

- CAUTION:** Do not autoclave the following components: Paw gauge, flow sensor, and bellows. These components cannot withstand immersion or the heat and pressure of autoclaving.
2. Clean the PAW gauge with a soft, lint-free cloth and a recommended cleaning agent (see TABLE 7-2 on page 7-8 and TABLE 7-3 on page 7-9). Allow it to dry thoroughly.
  3. Re-insert the PAW gauge if it was removed. Prior to use after cleaning or disinfecting, power up the system and follow the on-screen prompts to perform the leak test and the compliance test (see section 4.5 (page 4-8) "Leak and Compliance Tests").

## 7.9.8 Bag Arm

1. At the base of the bag arm, locate the retaining ring. Turn the ring counterclockwise until it is no longer threaded. Lift the bag arm from the breathing system block (see FIGURE 7-15).



**FIGURE 7-15** Bag Arm Removal

### 2. Cleaning

- a. Clean the bag arm with a soft, lint-free cloth and a recommended cleaning agent (see TABLE 7-2 on page 7-8). Allow it to dry thoroughly.
- b. If disinfecting the bag arm, continue with step 3, otherwise skip to step 4.

### 3. Disinfection

**NOTE:** Ensure that the bag arm has been cleaned as described in step 2 before disinfecting.

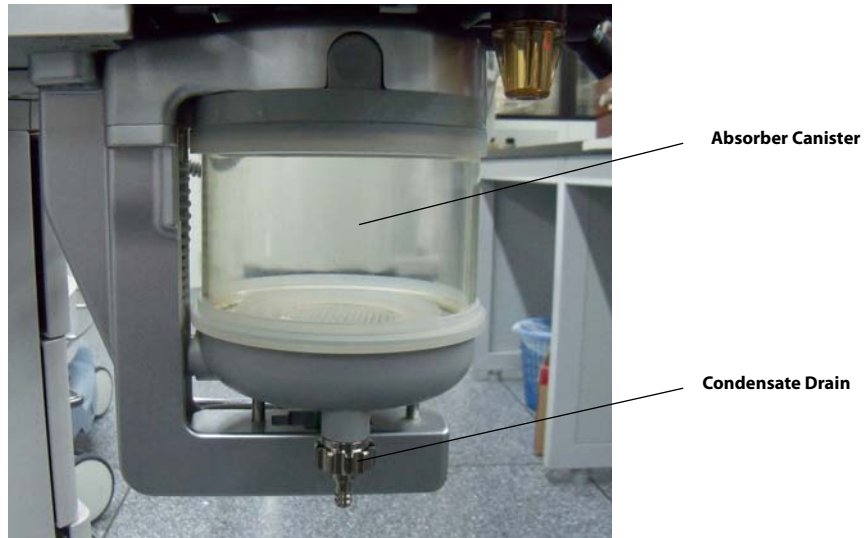
Use an approved disinfecting agent (see TABLE 7-3 on page 7-9 and TABLE 7-4 on page 7-9) for the bag arm while adhering to facility policies and procedures.

4. Reassemble the bag arm to the breathing system. Prior to use after cleaning or disinfecting, power up the system and follow the on-screen prompts to perform the leak test and the compliance test (see section 4.5 (page 4-8) "Leak and Compliance Tests").

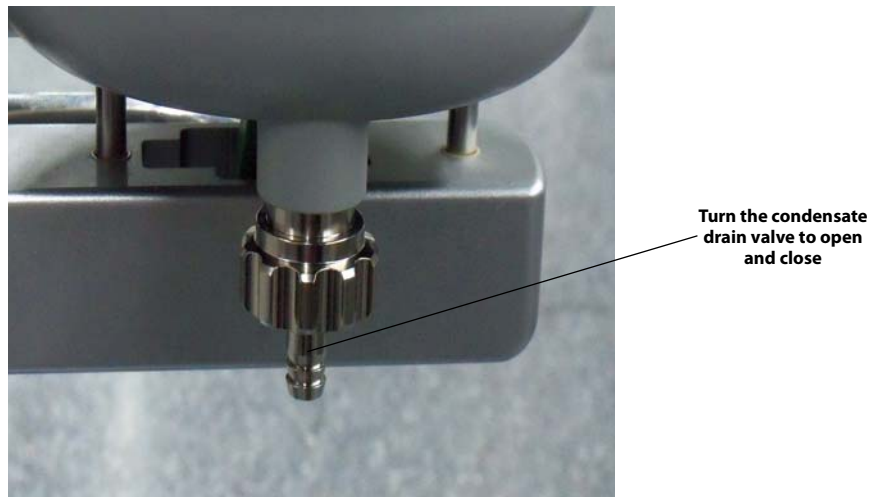


## 7.9.9 Absorber Canister

1. Locate the condensate drain valve at the bottom of the absorber canister assembly.



**FIGURE 7-16** Condensate Drain Valve Location



**FIGURE 7-17** Condensate Drain Valve (Close Up View)

2. While holding a small cup below the drain, turn the condensate drain valve clockwise to open the drain and collect any water that may have gathered. Turn the drain valve counter-clockwise to close the drain. Discard any water collected.

**WARNING:** Use extreme care while handling the absorbent as it contains a caustic irritant.

3. Rotate the locking mechanism handle clockwise into the unlocked position (see FIGURE 7-18). This separates the absorber canister from the top of the assembly. While noting the previous **WARNING**, remove the absorber canister. Then remove the Pre-Pak or loose fill absorbent from the canisters. Dispose of the absorbent as per the local regulations.



Unlocked Position      Gasket

**FIGURE 7-18** Absorber Canister, Unlocked



Gasket      Locked Position

**FIGURE 7-19** Absorber Canister, Locked

#### 4. Cleaning

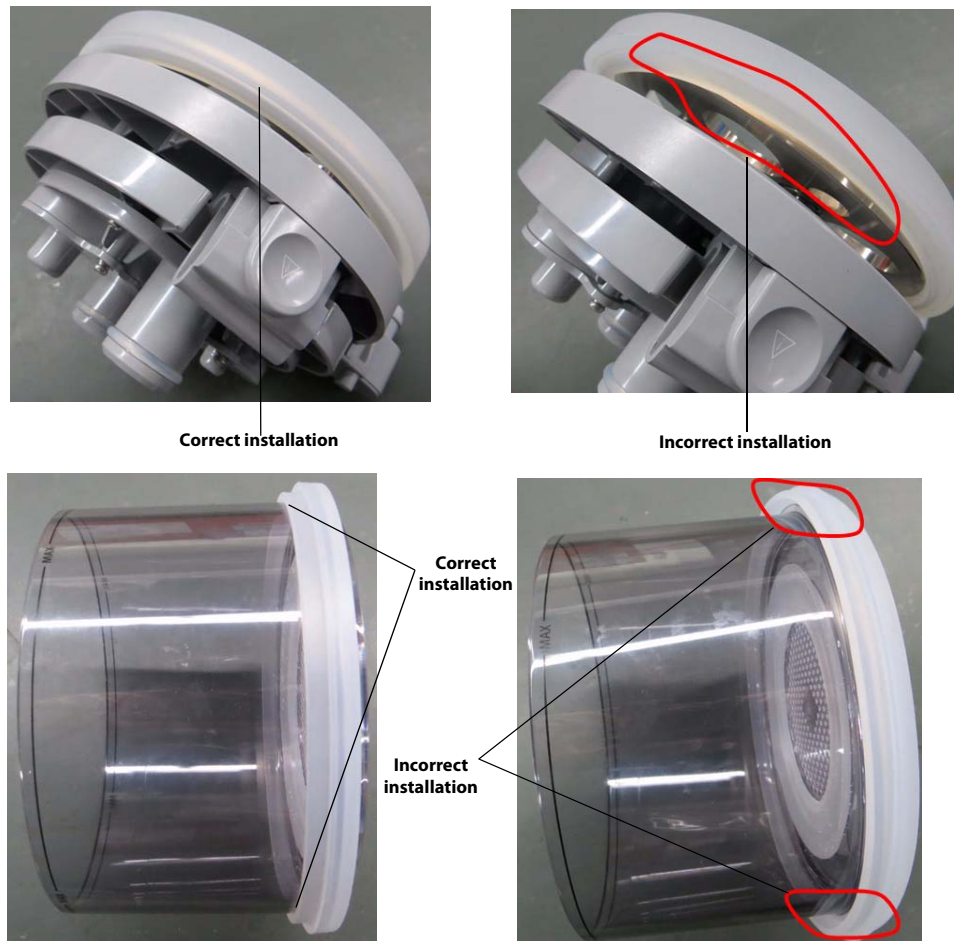
- a. Clean the absorber canister with a soft, lint-free cloth and a recommended cleaning agent (see TABLE 7-2 on page 7-8). Allow them to dry thoroughly.
- b. If disinfecting the absorber canister, continue with step 5, otherwise skip to step 7.

#### 5. Disinfection

**NOTE:**      **Ensure that the absorber canister has been cleaned as described in step 4 before disinfecting.**

Use an approved disinfecting agent (see TABLE 7-3 on page 7-9 and TABLE 7-4 on page 7-9) for the absorber canister while adhering to facility policies and procedures.

6. Make sure that the gasket is correctly installed. The comparison between correct installation and incorrect installation is shown below.



**FIGURE 7-20** Gasket installation

**WARNING:** Use extreme care while handling the absorbent as it contains a caustic irritant.

**WARNING:** Check if the gasket is properly installed in place while installing the absorber canister. If the gasket is not properly installed (for example, gasket is not evenly seated and centered) it may cause breathing system leakage.

**NOTE:** Ensure that the absorber canister is completely dry before adding absorbent.

- 7.** While noting the previous **WARNING**, add new Pre-Pak or loose fill absorbent to the absorber canister. Re-install the absorber canister into the assembly. Rotate the locking mechanism handle clockwise into the locked position (see FIGURE 7-19). Prior to use after cleaning or disinfecting, power up the system and follow the on-screen prompts to perform the leak test and the compliance test (see section 4.5 (page 4-8) "Leak and Compliance Tests").

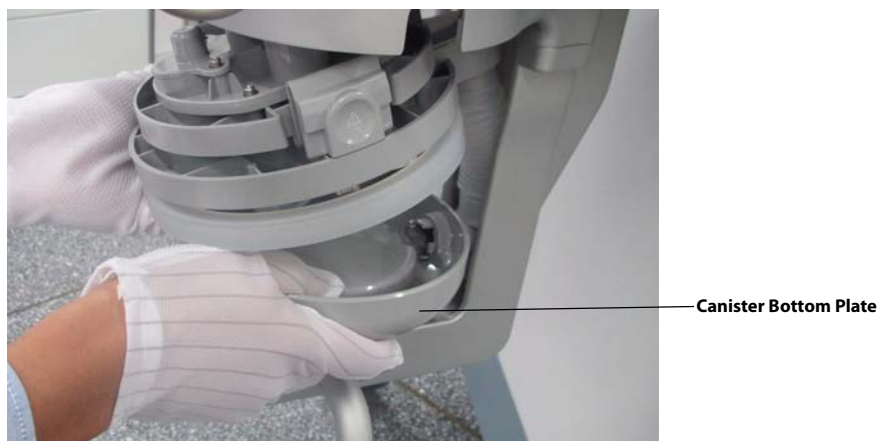
## 7.9.10 Breathing System Block

1. Remove all of the following components from the breathing system block:
  - Bellows Assembly
  - Inspiratory and Expiratory Valves (all components)
  - APL Valve
  - PAW Gauge
  - Bag Arm
  - Absorber Canister
  - Inspiratory and Expiratory Flow Sensors
2. Remove the absorber canister (see section 7.9.9 (page 7-19) "Absorber Canister").
3. Press and hold the buckle on the bypass assembly to take out the bypass assembly downward.



**FIGURE 7-21** Remove Bypass Assembly

4. Pull out the canister bottom plate upward.



**FIGURE 7-22** Remove Canister Bottom Plate

**CAUTION:** Use care in lifting and manipulating the breathing system block during removal from its mounting arm as handling may be awkward due to its weight and shape.

**CAUTION:** The breathing system block is calibrated and matched with the anesthesia machine at the factory. A label in the back of the machine indicates the serial number of the matching breathing system block. When reassembling, ensure that the breathing system block and anesthesia machine are properly matched. Otherwise, the breathing system must be recalibrated.

5. While holding the sides of the breathing system block, firmly separate and slide it away from its mounting arm.



**FIGURE 7-23** Breathing System Block Removal, Top View



**FIGURE 7-24** Breathing System Block Removal, Bottom View

## 6. Cleaning

- a. Clean the breathing system block exterior with a soft, lint-free cloth and a recommended cleaning agent (see TABLE 7-2 on page 7-8). Allow to dry thoroughly.
- b. If disinfecting the breathing system block, continue with step 7, otherwise skip to step 8.

## 7. Disinfection

**NOTE:**        **Ensure that the breathing system block has been cleaned as described in step 6 before disinfecting. High level disinfection of the breathing system block can be performed through steam autoclaving up to a maximum temperature of 134 °C (273 °F).**

Using an autoclave, follow the manufacturer's instructions for high level disinfection of the breathing system block while adhering to facility policies and procedures.

- 8.** Reassemble the breathing system components in reverse order. Prior to use after cleaning or disinfecting, power up the system and follow the on-screen prompts to perform the leak test and the compliance test (see section 4.5 (page 4-8) "Leak and Compliance Tests").

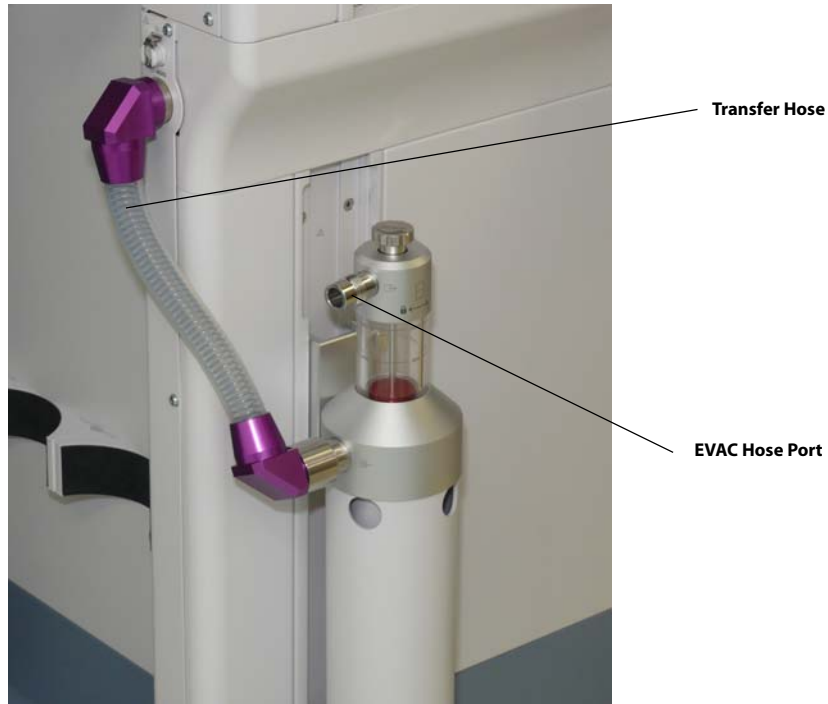
**CAUTION:**    **U.S. Federal Law restricts this device to sale by or on the order of a physician or other practitioner licensed by state law to use or order the use of this device.**

**CAUTION:**    **To ensure measurement accuracy and to avoid possible damage to the A7, use only Mindray-approved cables and accessories.**

**CAUTION:**    **Inspiratory and expiratory flow sensors are flow-direction-sensitive.**

### 7.9.11 Active AGSS (Anesthetic Gas Scavenging System) and AGSS Transfer Hose

1. Disconnect the EVAC hose from the AGSS (see FIGURE 7-25).
2. Remove the AGSS and Transfer Hose from the A7.



**FIGURE 7-25** AGSS and Transfer Hose Removal

3. Clean the outer surface of the AGSS and Transfer Hose with a soft, lint-free cloth and a recommended cleaning agent (see TABLE 7-2 on page 7-8). Allow to dry thoroughly.
4. Remove the top of the AGSS (see FIGURE 7-26). Inspect the AGSS filter and shake it over a waste container to clean it as necessary. If the filter must be replaced, dispose of the old filter per local disposal regulations.



**FIGURE 7-26** Removal of AGSS Top / AGSS Filter Inspection

5. Reassemble the AGSS and Transfer Hose and reconnect them to the A7 in the reverse order.

## 7.10 Regular Maintenance

**WARNING:** To avoid endangering a patient, do not perform testing or maintenance when the machine is in use.

Visual inspection should be performed every 30 days to ensure timely replacement of worn or damaged parts.

1. Power off the system.
2. Perform an overall visual inspection of the system.
3. Power up the system and follow the on-screen prompts to perform the leak test and the compliance test (see section 4.5 (page 4-8) "Leak and Compliance Tests").



# **AG and O<sub>2</sub> Concentration Monitoring**

---

Introduction .....	8-2
Understand MAC Values.....	8-3
Agent Usage Calculation .....	8-4
Identify External AG Modules.....	8-5
Prepare to Measure AG.....	8-6
Make AG Settings.....	8-7
Measurement Limitations .....	8-9
Troubleshooting.....	8-9
Sample Gas Recirculation .....	8-10
Calibrate the AG Module .....	8-11

## 8.1 Introduction

The Anaesthetic Gas (AG) module measures the patient's anesthetic and respiratory gases, and incorporates the features of the O<sub>2</sub> module as well.

The AG (anesthesia gas) module determines the concentrations of certain gases using the infrared (IR) light absorption measurement. The measured AG module gases absorb IR light. Each gas has its own absorption characteristic. The gas is transported into a sample cell, and an optical IR filter selects a specific band of IR light to pass through the gas. For multiple gas measurements, there are multiple IR filters. This means that higher concentration of IR absorbing gas causes a lower transmission of IR light. The amount of IR light transmitted after it has been passed through an IR absorbing gas is measured. From the amount of IR light measured, the concentration of gas present can be calculated.

Oxygen does not absorb IR light as other breathing gases and is therefore measured relying on its paramagnetic properties. Inside the O<sub>2</sub> sensor are two nitrogen-filled glass spheres mounted on a strong rare metal taut-band suspension. This assembly is suspended in a symmetrical non-uniform magnetic field. In the presence of paramagnetic oxygen, the glass spheres are pushed further away from the strongest part of the magnetic field. The strength of the torque acting on the suspension is proportional to the oxygen concentration. From the strength of the torque, the concentration of oxygen is calculated.

The measurement provides:

1. An EtCO<sub>2</sub> waveform;
2. Measured parameters: EtCO<sub>2</sub>, FiCO<sub>2</sub>, EtN<sub>2</sub>O, FiN<sub>2</sub>O, EtAA, FiAA and MAC, where, AA stands for any of the five anesthetic agents: Des (desflurane), Iso (isoflurane), Enf (enflurane), Sev (sevoflurane), or Hal (halothane).

## 8.2 Understand MAC Values

Minimum alveolar concentration (hereinafter referred to as MAC) displays on the screen when the anesthesia system is configured with an external AG module.

MAC is a basic index indicating the depth of inhaled anesthesia. The ISO 80601-2-55 defines MAC as follows: alveolar concentration of an inhaled anesthetic agent that, in the absence of other anesthetic agents and at equilibrium, prevents 50% of subjects from moving in response to a standard surgical stimulus.

The following table lists 1 MAC of various inhaled anesthetic agents.

Anesthetic agent	Des	Iso	Enf	Sev	Hal	N <sub>2</sub> O
1 MAC	6.0%	1.15%	1.7%	2.1%	0.77%	105%*

\* 1 MAC nitrous oxide can only be reached in a hyperbaric chamber.

**TABLE 8-1** 1 MAC of various inhaled anesthetic agents

**NOTE:** The data shown in this table is from ISO 80601-2-55, which are published by the U.S. Food and Drug Administration for a healthy 40-year-old male patient.

**NOTE:** In actual applications, although the A7 accounts for patient age, the effects of weight and other factors on the inhaled anesthetic agent should be considered.

When one or more than one anesthetic agents are used, the formula for calculating MAC is:

$$MAC = \sum_{i=0}^{N-1} \frac{EtAgent_i}{AgentVol_{age}i}$$

Where, N stands for the number of all anesthetic agents (including N<sub>2</sub>O) which the AG module can measure, EtAgent<sub>i</sub> for the concentration of end-tidal anesthetic agent and AgentVol<sub>age</sub><sub>i</sub> for the 1MAC value corresponding to the anesthetic agent after age correction.

The formula for calculating age correction of 1MAC is:

$$MAC_{age} = MAC_{40} \times 10^{(-0.00269 \times (age-40))}$$

**NOTE:** The formula above is only suitable for patients who are older than one year old. If the patient is less than one year old, the system will use one year to do age correction.

For example, for a 60-year-old patient, if the AG module detects 0.9% Iso and 50% N<sub>2</sub>O in the patient end-tidal mixed gas, the 1MAC of Iso is 1.01% and 1MAC of N<sub>2</sub>O is 92.7% of the 60-year-old patient based on the above age correction formula. The MAC value is calculated as follows:

$$MAC = \frac{0.9\%}{1.01\%} + \frac{50\%}{92.7\%} = 1.4$$

## 8.3 Agent Usage Calculation

**CAUTION:** Agent calculation has an accuracy of +/- 25% and therefore should only be used for administrative purposes and not for making clinical decisions.

The A7 can calculate the usage of the agents when configured with an internal AG module. The agent usage displays on the screen in **Standby** mode. The agent usage accumulates from 0 when the A7 exits the **Standby** mode. When A7 enters **Standby**, the agent usage stops accumulating. If the A7 restarts within not more than 60s after accidental power failure, when the case is not ended, the anesthetic agent usage will continue accumulating until the A7 enters **Standby** mode.



**FIGURE 8-1** Agent Usage Calculation

## 8.4 Agent Consumption Speed (Software Bundle Version 02.11.00 or later)

When anesthesia system is configured with internal AG module, A7 can calculate the agent consumption speed (the approximately agent used per hour) and the cost.

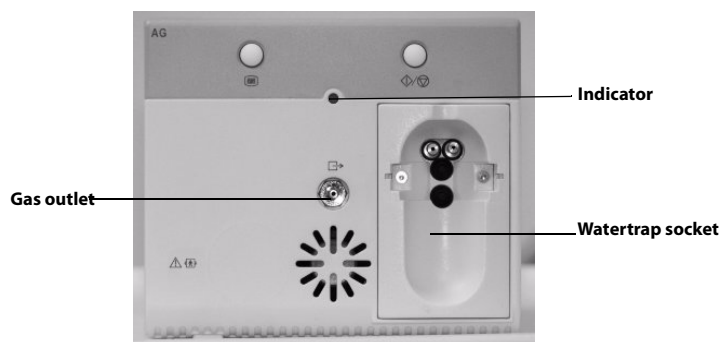


**FIGURE 8-2** Agent Consumption Speed

To set the cost per hour:

1. Select **Setup** softkey > **System** tab (system password needed) > **Optimizer**® button.
2. Set the cost of the anesthesia agent per hour to display cost.

## 8.5 Identify External AG Modules



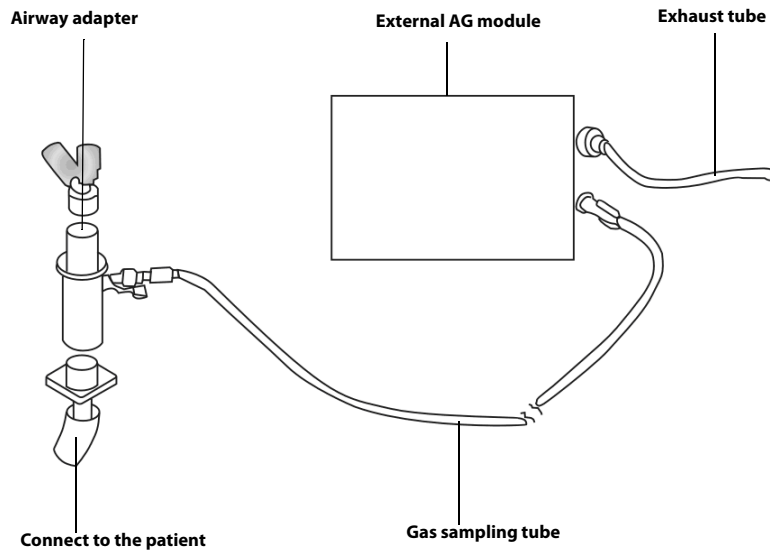
**FIGURE 8-3** External AG Module

**NOTE:** The AG module (see FIGURE 8-3) is configured with the function of compensating barometric pressure automatically.

**NOTE:** The hardkey on the AG module has been disabled.

## 8.6 Prepare to Measure AG

1. Select the appropriate watertrap according to patient type and attach it to the watertrap socket.
2. Connect one end of the gas sampling tube to the watertrap.
3. Connect the other end of the gas sampling tube to the patient via the airway adapter.
4. Connect the exhaust tube to the gas outlet on the module to scavenge the sample gas to the waste gas disposal system.



**FIGURE 8-4** Prepare to Measure AG

**CAUTION:** Position the airway adapter properly so that the part connecting to the gas sampling tube is pointing upwards. This prevents condensed water from entering the gas sampling tube and causing an occlusion as a result.

**CAUTION:** The watertrap collects water drops condensed in the sampling tube and therefore prevents them from entering the module. If the collected water reaches a certain amount, you should drain it to avoid airway blockage.

**CAUTION:** The watertrap has a filter preventing bacterium, vapor and patient secretions from entering the module. After long-term use, dust or other substances may compromise the performance of the filter or even block the airway. In this case, replace the watertrap. Replacing the watertrap once a month is recommended.

**WARNING:** Do not use high volume watertraps with Infant patients. Otherwise, patient injury could result.

**WARNING:** Make sure that all connections are reliable. Any leak in the system can result in erroneous readings due to patient breathing gas mixed with ambient air.

## 8.7 Make AG Settings

Perform the settings below when the anesthesia system is configured with an external AG module.

### 8.7.1 Set CO<sub>2</sub> Unit

**To change the CO<sub>2</sub> Unit:**

1. Select **Setup** softkey > **System** tab.
2. Select the **CO<sub>2</sub> Unit** button.
3. Choose between **mmHg, kPa** and **%**.
4. Select the **Accept** button to confirm the change, or select the **Cancel** button to disregard the change.

### 8.7.2 Set CO<sub>2</sub> Placement

**To change the CO<sub>2</sub> Placement:**

1. Select **Setup** softkey > **Display** tab.
2. Select the **CO<sub>2</sub> Placement** button.
3. Choose between **Top** and **Bottom**.
4. Select the **Accept** button to confirm the change, or select the **Cancel** button to disregard the change.

### 8.7.3 Set CO<sub>2</sub> Scale

**To change the CO<sub>2</sub> Scale:**

1. Select **Setup** softkey > **Display** tab.
2. Select the **CO<sub>2</sub> Scale** button.
3. Choose the desired scale.
4. Select the **Accept** button to confirm the change, or select the **Cancel** button to disregard the change.

### 8.7.4 Gas Bench Flow Rate

**To change the Gas Bench Flow Rate:**

1. Select **Setup** softkey > **General** tab.
2. Select the **Gas Bench Flow Rate** button.
3. Choose between **High** (recommended), **Med** and **Low**, as follows:  
**High:** 200 ml/min for high volume watertrap; 120 ml/min for low volume watertrap  
**Med:** 150 ml/min for high volume watertrap; 90 ml/min for low volume watertrap  
**Low:** 120 ml/min for high volume watertrap; 70 ml/min for low volume watertrap
4. Select the **Accept** button to confirm the change, or select the **Cancel** button to disregard the change.

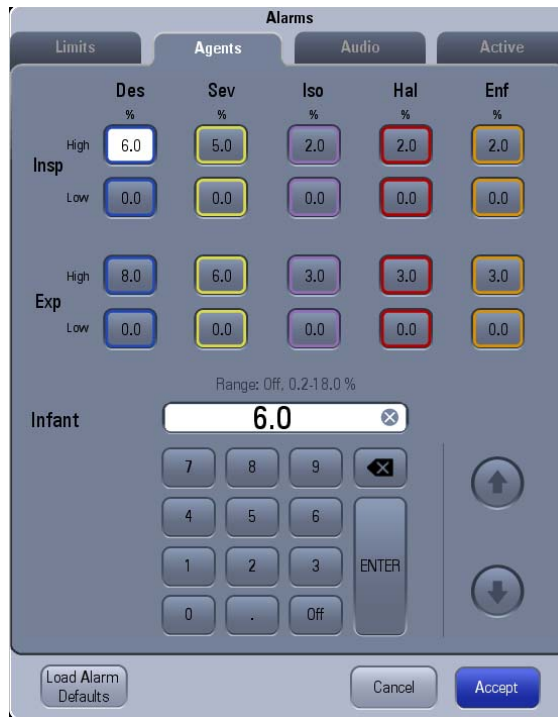
## 8.7.5 Set Alarm Limits

Users can set the high and low alarm limits of N<sub>2</sub>O, CO<sub>2</sub>, and Agents to create alarm conditions consistent with patient needs. The alarm is then triggered when the parameter value is greater than the High Limit or lesser than the Low Limit.

**NOTE:** When using the A7 Anesthesia System, ensure that the alarm limits of each parameter are set to the appropriate values for the patient.

To set the Alarm Limits:

1. On the main screen, select the **Alarms** softkey.  
The **Alarms** window is displayed.
2. Select the **Limits** tab (see FIGURE 6-6) or **Agents** tab (see FIGURE 8-5).
3. Select a parameter softkey.  
The softkey is highlighted when selected.
4. Use the on-screen keypad to enter the desired parameter value.  
For each parameter, the range of values displays above the keypad.
5. Optionally, to restore the default values, select the **Load Alarm Defaults** button. This restores the high and low values for the parameters to the user default values.
6. Select the **Accept** button to confirm the change, or select the **Cancel** button to disregard the change.
7. Repeat steps 3 to 6 for each parameter value.



**FIGURE 8-5** Agents tab



## 8.8 Measurement Limitations

Measurement accuracy may degrade due to:

- Leakage or internal leakage of the sample gas
- Mechanical shock
- Humidity or condensate
- Cyclic pressure which is greater than 10 kPa (100 cmH<sub>2</sub>O)
- Other interference source (if available)

**NOTE:** Gas data is reported as zero if the measured concentration is below the defined threshold level during more than 3 s: CO<sub>2</sub> - 0.1/0.3%; N<sub>2</sub>O - 3/3%; O<sub>2</sub> - 0/0%, Agents - 0.15/0.3% (Full/ISO accuracy).

**NOTE:** Inaccuracy is specified at 10-55 °C operating temperature and default compensated for an H<sub>2</sub>O partial pressure of 11 mBar (i.e. 22 °C @40% RH ambient conditions) and using a DRYLINE™ sampling system. Any other ambient H<sub>2</sub>O partial pressure will dilute the gas sample to a different extent, causing a measurement error. Under typical operating conditions this effect is negligible. An increase of the ambient H<sub>2</sub>O partial pressure to 30 mBar (i.e. 28 °C @80% RH or 33 °C @60% RH) will cause a general error for all measured gases of -2%<sub>REL</sub>. For automatic compensation of the ambient humidity effect on the gas sample composition, the actual ambient H<sub>2</sub>O partial pressure can be input to AION™ from the host via the communication interface.

## 8.9 Troubleshooting

If the gas inlet (including watertrap, sampling tube and airway adapter) is occluded by condensed water, airway occlusion will be prompted on the screen.

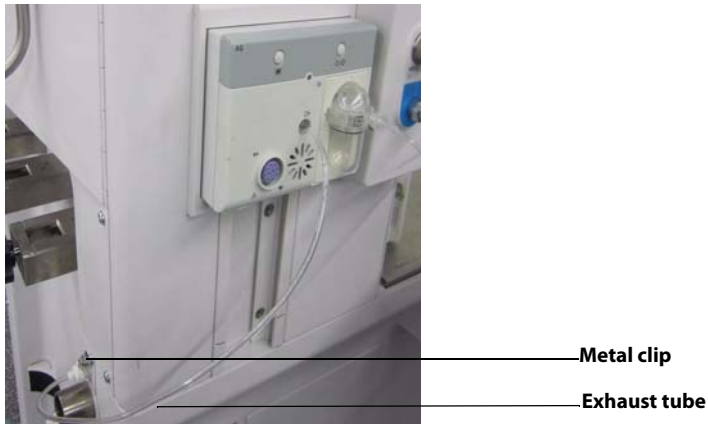
To remove the occlusion:

- Check the airway adapter for occlusion and replace if necessary.
- Check the sampling tube for occlusion or kinking and replace if necessary.
- Check the watertrap for water build-up. Empty the watertrap. If necessary, replace the watertrap.

If that does not resolve it, internal occlusions may exist. Contact your service personnel.

If the expired O<sub>2</sub> concentration is higher than the inspired O<sub>2</sub> concentration, it is possible that the pump rate is too low. Setting **Gas Bench Flow Rate** to **High** is recommended.

## 8.10 Sample Gas Recirculation



**FIGURE 8-6** Sample Gas Recycling

To return the sample gas to the patient circuit, depress the metal clip and then plug the exhaust tube to the sample gas return port marked **A.** ← as shown in the above picture.

**WARNING:** When using the AG module to perform AG measurements on the patients who are receiving or have recently received anesthetic agents, connect the outlet to the sample gas return port to prevent the medical staff from breathing in the anesthetic agents.

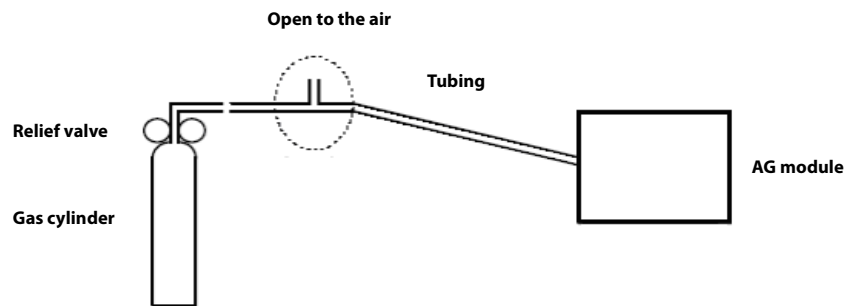
## 8.11 Calibrate the AG Module

Prepare the following before doing the calibration:

- Gas cylinder, with a certain standard gas or mixture gas. Gas concentration should meet the following requirements: AA $\geq$ 1.5%, CO<sub>2</sub> $\geq$ 1.5%, N<sub>2</sub>O $\geq$ 40%, O<sub>2</sub> $\geq$ 40%, of which AA represents an anesthetic agent.  $a/c \leq 0.01$  (a is the gas absolute concentration accuracy; c is the gas concentration).
- T-shape connector
- Tubing

Follow this procedure to perform a calibration:

1. Connect the test system as follows.



2. Ensure that the system is in **Standby** mode. If not, select the **End Case** button in the **Manual** tab and follow the on-screen prompts to end the case and enter **Standby** mode.
3. Select the **Setup** softkey > **System** tab (system password needed).
4. Select the **Calibration** button.
5. Select the **Internal AG Module** or **External AG Module** button.
6. Wait for the AG module to be completely warmed up.
7. Enter the actual concentration of the calibration gas.
8. Turn on the calibration gas canister. The system displays the real-time concentration of calibration gas.
9. Select the **Calibrate** button to start to calibrate the AG Module. The system displays the results of the calibration status when the process is completed.
10. After calibration, select the **Done** button to close the **Calibration** window.
11. Select the **Accept** button to confirm the change, or select the **Cancel** button to discard the change.

**This page intentionally left blank.**

# **Product Specifications**

---

Standards Compliance .....	9-2
Safety Designations.....	9-3
Physical Specifications.....	9-5
Stability Configurations and Conditions .....	9-5
Environmental Specifications.....	9-6
Electrical Specifications.....	9-6
Pneumatic Specifications.....	9-7
Breathing System Specifications.....	9-9
Anesthetic Gas Scavenging System (AGSS) .....	9-13
Suction device .....	9-13
Monitor Module.....	9-14
Ventilator Specifications .....	9-18
Displays and Controls Specifications.....	9-20
Alarms .....	9-22
Safety Specifications .....	9-22
ASTM F 1208 – 89 (2005) Disclosures.....	9-23
Data Storage (Non-Volatile) and Recording .....	9-24
Electromagnetic Compatibility .....	9-26

## 9.1 Standards Compliance

The A7 Anesthesia System is in compliance with the following industry standards.

ANSI / AAMI ES60601-1:2005/(R)2012 and C1:2009/(R)2012 and, A2:2010/(R)2012 (consolidated text)	Medical electrical equipment - Part 1: General requirements for basic safety and essential performance
IEC 60601-1-2:2007	Medical electrical equipment - Part 1-2: General requirements for basic safety and essential performance - Collateral standard: Electromagnetic compatibility - Requirements and tests
IEC 60601-1-6:2010	Medical electrical equipment - Part 1-6: General requirements for basic safety and essential performance - collateral standard: usability
IEC 60601-1-8:2006	Medical electrical equipment - Part 1-8: General requirements for basic safety and essential performance - Collateral standard: General requirements, tests and guidance for alarm systems in medical electrical equipment and medical electrical system
IEC 62304:2006	Medical device software - Software life cycle processes
IEC 62366 Edition 1.1 2014-01	Medical Devices - Application of Usability Engineering to Medical Devices
ISO10993-1:2009	Biological Evaluation of Medical Devices - Part 1: Evaluation and Testing Within A Risk Management Process
ANSI/AAMI/ ISO 10993-5:2009	Biological Evaluation of Medical Devices -- Part 5: Tests for in Vitro Cytotoxicity
ISO 10993-10:2010	Biological Evaluation Of Medical Devices -- Part 10: Tests for irritation and skin sensitization
ISO10993-18:2005	Biological evaluation of medical devices -- Part 18: Chemical characterization of materials
ISO14971:2007	Medical Devices - Application of Risk Management to Medical Devices
ISO 15223-1:2012	Medical Devices - Symbols to be used with Medical Device Labels, Labelling, and Information to be supplied - Part 1: General Requirements
ISO 80601-2-13:2011	Medical electrical equipment —Part 2-13: Particular requirements for basic safety and essential performance of an anaesthetic workstation
ISO 80601-2-55:2011	Medical electrical equipment - Part 2-55: Particular requirements for the basic safety and essential performance of respiratory gas monitors
ISO 5356-1:2004	Anaesthetic and respiratory equipment - conical connectors: Part 1: cones and sockets
CGA V-1:2013	Standard for Compressed Gas Cylinder Valves Outlet and Inlet Connections
CGA V-5:2008 (Reaffirmed 2013)	Diameter-Index Safety System (Noninterchangeable Low Pressure Connections for Medical Gas Applications)
ASTM F1101-90 (Reapproved 2003)	Standard specification for ventilators intended for use during anesthesia

**TABLE 9-1** Standards Compliance

The anesthesia workstation shall be used together with the monitoring devices, alarm system and protective devices below:

- The pressure measurement device in compliance with ISO 80601-2-13;
- The pressure restriction device in compliance with ISO 80601-2-13;
- The expiratory volume monitor in compliance with ISO 80601-2-13;
- The breathing system with alarm system in compliance with ISO 80601-2-13;
- The anaesthetic vapour delivery system in compliance with ISO 80601-2-13;
- The anaesthetic gas scavenging system in compliance with ISO 80601-2-13;
- The anesthetic gas delivery device in compliance with ISO 80601-2-13;
- The anesthetic ventilator in compliance with ISO 80601-2-13;
- The O<sub>2</sub> monitor in compliance with ISO 80601-2-55;
- The CO<sub>2</sub> monitor in compliance with ISO 80601-2-55;
- The AG monitor in compliance with ISO 80601-2-55.

The anesthesia workstation is integrated with the pressure measurement device, pressure restriction device, expiratory volume monitor, anaesthetic breathing system with alarm system, anaesthetic gas delivery system, anaesthetic vapour delivery system, anaesthetic ventilator, AG monitor in compliance with the afore mentioned standards, where:

- The pressure restriction device, expiratory volume monitor and breathing system with alarm system also comply with ISO 80601-2-13.
- AG monitor in compliance with ISO 80601-2-55.

## 9.2 Safety Designations

<b>Type of Protection against Electric Shock:</b>	Class I equipment with internal electric power supply. Where the integrity of the external protective earth (ground) in the installation or its conductors is in doubt, the equipment shall be operated from its internal electric power supply (i.e., battery supply).
<b>Degree of Protection against Electric Shock:</b>	BF, defibrillation-proof
<b>Power Supply Connection:</b>	External electric power supply: 100 to 120 VAC, 50/60 Hz, 12 A  Internal battery supply: Lithium-ion, 11.1 V, 4.5 Ah ( 2 batteries installed)
<b>Mode of Operation:</b>	Continuous
<b>Degree of Protection against Hazards of Explosion:</b>	Ordinary equipment, without protection against explosion; not for use with flammable anesthetics.
<b>Degree of Protection against Harmful Ingress of Water:</b>	Protection against vertically falling water drops - IPX1 (IEC 60529)
<b>Electrical Connection between Equipment and Patient:</b>	Equipment designed for non-electrical connection to the patient
<b>Degree of Mobility:</b>	Mobile: including the base and casters of the anesthesia system
<b>Disinfection:</b>	Steam autoclavable or disinfectable

**TABLE 9-2** Safety Designations

### 9.2.1 Oxygen Enriched Environments

The A7 complies with the standards for oxygen-enriched environments by staying below the required power threshold or by providing forced ventilation and ventilation failure monitoring and alarm.

### 9.2.2 Wiring and PC Board Materials

The A7 complies with NRTL standards for wiring and PC board materials. Primary wiring is double insulated (jacketed). All wires are UL recognized.



## 9.3 Physical Specifications

<b>Dimensions:</b>	Height: 1400 mm $\pm$ 25 mm Width: 1050 mm $\pm$ 25 mm (including breathing system) Depth: 805 mm $\pm$ 25 mm
<b>Weight:</b>	185 kg (353 lbs) $\pm$ 5 kg (with AG module, Auxiliary work surface and 3 Yokes, without vaporizers and gas cylinders)
<b>Work Surface (stainless steel):</b>	Width: 616 mm (26 in) $\pm$ 25 mm Depth: 380 mm (15 in) $\pm$ 25 mm Height: 850 mm (33.5 in) $\pm$ 25 mm
<b>Auxiliary work surface</b>	Weight limit: 10 kg (22 lbs) Width: 450 mm $\pm$ 25 mm Depth: 330 mm $\pm$ 25 mm Height: 750 mm $\pm$ 25 mm
<b>Top Shelf:</b>	Weight Capacity: 40 kg (88 lbs) Width: 616 mm (26 in) $\pm$ 25 mm Depth: 362 mm (15 in) $\pm$ 25 mm
<b>Side Mounting Rails:</b>	Supporting weight: 27 kg at a maximum distance of 0.41 m
<b>Bag Arm:</b>	<b>Fixed Height Bag Arm:</b> Length: 312 mm $\pm$ 10 mm Height: 1150 mm $\pm$ 10 mm Swiveling angle: 150 $\pm$ 10 degrees <b>Flexible Bag Arm:</b> Length: 550mm $\pm$ 10mm The height and angle of the flexible bag arm can be adjusted freely.
<b>Drawers (internal dimensions):</b>	Weight limit: 5 kg (11 lbs) Drawers are of equal size: • Height: 135 mm $\pm$ 10 mm • Width: 440 mm $\pm$ 10 mm • Depth: 385 mm $\pm$ 10 mm
<b>Casters:</b>	Diameter: 15 cm (6 in) $\pm$ 2 mm Brake: central brake with lock/unlock indicator Cable pusher: cable pusher with each caster
<b>Handle</b>	Length: 650 mm $\pm$ 25 mm

TABLE 9-3 Physical Specifications

## 9.4 Stability Configurations and Conditions

Maintains stability when tilted 10 degrees, as required by ANSI/AAMI ES60601-1, clause 9.4.

**WARNING:** Due to the size and weight of the A7, it should only be moved by qualified personnel.

**WARNING:** Excess load may cause a tip hazard while moving the A7. Before moving, remove all equipment from the top shelf and all monitoring equipment mounted to the side of the A7. Use care when moving the A7 up or down inclines, around corners, and across thresholds. Do not attempt to roll the A7 over hoses, cords, or other obstacles.

## 9.5 Environmental Specifications

<b>Operating Temperature:</b>	+10 to +40°C +50 to 104°F
<b>Storage Temperature:</b>	-20 to +60°C -4 to 140°F
<b>Humidity (Operating and Storage):</b>	15 to 90% RH, non-condensing
<b>Atmospheric Pressure (Operating):</b>	70 kPa to 106.7 kPa
<b>Atmospheric Pressure (Storage):</b>	50 kPa to 106.7 kPa
<b>Resistance to Ingress of Water:</b>	Complies with the requirements of clause 11.6.3 in IEC 60601-1 and also the requirements in IEC 60529 for protection against vertically falling water drops (IPX1)

TABLE 9-4 Environmental Specifications

## 9.6 Electrical Specifications

### 9.6.1 Main Electrical Power Specifications

The A7 complies with ANSI/AAMI ES60601-1 for its main power supply.

<b>Power Supply Input Voltage:</b>	100 to 120 VAC @ 50/60 Hz
<b>Power Supply Input Current:</b>	2 A maximum for A7 unit 10 A maximum for A7 auxiliary outlets
<b>Power Cord:</b>	5 ± 0.05 m (length) Hospital grade (grade of power cord)

TABLE 9-5 Main Electrical Power Specifications

### 9.6.2 Battery Power Specifications

<b>Battery Type:</b>	Sealed Lithium-ion, 11.1 V, 4.5 Ah Two (2) batteries
<b>Battery Run-time:</b>	Two (2) new batteries installed: > 90 minutes Run-time criteria: <ul style="list-style-type: none"> <li>• VCV mode: Tv = 500 ml, Rate = 10 bpm, I:E = 1:2, Plimit = 30 cmH<sub>2</sub>O, PEEP = OFF, Tpause=OFF, Resistance=20 cmH<sub>2</sub>O/L/s, Compliance=20 ml/cmH<sub>2</sub>O</li> <li>• AG module Sampling rate: 120 ml/min</li> <li>• O<sub>2</sub> flow of Electronic mixer: 1 L/min</li> <li>• Sound setting: default</li> <li>• Display setting: default</li> <li>• Work light settings: low</li> </ul>
<b>Time to Shutdown from Lower Battery Alarm:</b>	5 minutes at least (powered by new fully-charged batteries after the first low-power alarm)
<b>Battery Charge Time:</b>	New Battery: < 8 hours from an initial charge of 10 %. Charging occurs whenever AC is applied to the A7 System.

TABLE 9-6 Battery Power Specifications

### 9.6.3 Auxiliary Electrical Outlets

<b>Number of Outlets:</b>	4
<b>Output Voltage:</b>	Corresponds to power supply input voltage
<b>Output Current of Each Auxiliary Outlet:</b>	3 A
<b>Output Current Total:</b>	10 A
<b>Breaker Rating per Auxiliary Outlet:</b>	3 A
<b>Breaker Rating Total:</b>	10 A

**TABLE 9-7** Auxiliary Electrical Outlets

### 9.6.4 Communication Ports

<b>Communication Port (SP1):</b>	One DB9 male connector on the rear of the A7. Provides a non-isolated output serial RS232C interface.
	<b>NOTE:</b> Do not connect any non-isolated devices to the DB9/RS232C interface of the A7.
<b>Network Port (CS1):</b>	One RJ-45 network port
<b>SB Ports (SB1, SB2):</b>	Two SB ports
	<b>CAUTION:</b> Do not connect any devices to the SB ports other than Mindray approved USB storage devices and a supported USB mouse (See "Networking and USB Storage" on page A-4.).
<b>Data Port (DP1):</b>	One test port for connection of calibration equipment by a Mindray-authorized service representative
<b>VGA Port (optional):</b>	One VGA port for inputting the VGA video signal of the main display to external display.

**TABLE 9-8** Communication Ports

## 9.7 Pneumatic Specifications

### 9.7.1 Pipeline Supply

<b>Pipeline Input Pressure Range:</b>	O <sub>2</sub> : 280 to 600 kPa (40 to 87 psi) N <sub>2</sub> O: 280 to 600 kPa (40 to 87 psi) Air: 280 to 600 kPa (40 to 87 psi)
<b>Pipeline Input Flow Rate Range:</b>	O <sub>2</sub> : Max. 190 L/min (Including maximum drive gas flow rate, maximum flow rate to seal PEEP valve, maximum O <sub>2</sub> Flow meter and maximum O <sub>2</sub> flush) Air: Max. 20 L/min N <sub>2</sub> O: Max. 20 L/min

**TABLE 9-9** Pipeline Supply

<b>Pipeline Connections:</b>	DISS threaded body as per CGA V-5
<b>Gas Configuration:</b>	N <sub>2</sub> O, Air, O <sub>2</sub>

**TABLE 9-9** Pipeline Supply

## 9.7.2 Cylinder Supply

<b>Cylinder Supply:</b>	E-cylinder (American style) and pin indexed per CGA V-1
<b>O<sub>2</sub> Cylinder Input Pressure Range:</b>	6.9 to 15.5 MPa (1000 to 2250 psi)
<b>N<sub>2</sub>O Cylinder Input Pressure Range:</b>	4.2 to 6 MPa (600 to 870 psi)
<b>Air Cylinder Input Pressure Range:</b>	6.9 to 15.5 MPa (1000 to 2250 psi)
<b>Cylinder Input Flow Rate Range:</b>	O <sub>2</sub> : Max. 190 L/min (Including maximum drive gas flow rate, maximum flow rate to seal PEEP valve, maximum O <sub>2</sub> Flow meter and maximum O <sub>2</sub> flush) Air: Max. 20 L/min N <sub>2</sub> O: Max. 20 L/min
<b>Cylinder Connections:</b>	Pin-Index Safety System (PISS)
<b>Yoke Configuration:</b>	O <sub>2</sub> , Air, N <sub>2</sub> O (left to right, viewing rear of unit)

**TABLE 9-10** Cylinder Supply

## 9.7.3 Auxiliary Common Gas Outlet (ACGO)

<b>Control type</b>	Electronic
<b>Connector:</b>	Standard 22 mm OD and 15 mm ID conical connectors as per ISO 5356-1
<b>Safety pressure:</b>	A relief valve limits fresh gas pressure at the ACGO outlet port to not more than 125 cmH <sub>2</sub> O.
<b>Fresh gas flow</b>	0.2 to 18 L/min

**TABLE 9-11** ACGO

## 9.7.4 Vaporizer Connections

<b>Vaporizer Positions:</b>	Two vaporizer mount or three vaporizer mount
<b>Vaporizer Parking Mount:</b>	Inactive, for storage only
<b>Mounting Mode:</b>	Selectatec <sup>®</sup> , with interlocking function (Selectatec <sup>®</sup> is registered trademark of Datex-Ohmeda Inc.)

**TABLE 9-12** Vaporizer Connections

## 9.7.5 Drive Gas

O<sub>2</sub>

## 9.7.6 O<sub>2</sub> Controls

O<sub>2</sub> supply failure alarm: 185.5 to 254.5 kPa (27 to 36 psi)

## 9.8 Breathing System Specifications

### 9.8.1 Breathing System Volume

<b>Automatic Ventilation:</b>	Total volume: 4350 ml +/-100 ml (including bellows) Bellows: 1500 ml +/-100 ml
<b>Manual Ventilation:</b>	Total volume: 3300 ml +/-100 ml (not including breathing bag)

**TABLE 9-13** Breathing System Volume

### 9.8.2 CO<sub>2</sub> Absorber Assembly

<b>Absorber Capacity:</b>	1 Pre-Pak (1500ml ± 100 ml)
<b>Absorber Canister Contents:</b>	1 Pre-Pak canister or Loose Fill absorbent

**TABLE 9-14** CO<sub>2</sub> Absorber Assembly

### 9.8.3 Water Collection Cup

<b>Mode:</b>	Detachable separately
<b>Capacity:</b>	6 ml ± 1 ml

**TABLE 9-15** Water Collection Cup

### 9.8.4 Breathing System Connections

<b>Exhalation Connection:</b>	Standard 22 mm OD and 15 mm ID conical connectors as per ISO 5356-1
<b>Inhalation Connection:</b>	Standard 22 mm OD and 15 mm ID conical connectors as per ISO 5356-1
<b>Exhaust port:</b>	Standard 30 mm OD conical connectors as per ISO 5356-1

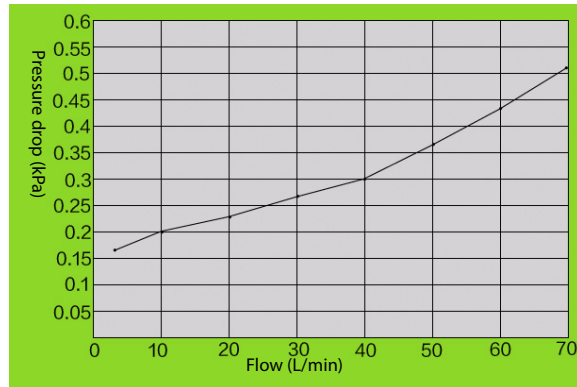
**TABLE 9-16** Breathing System Connections

### 9.8.5 APL Valve

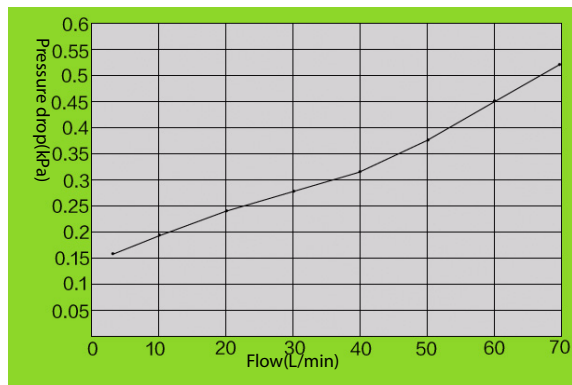
<b>Range:</b>	SP, Approximately 0 to 75 cmH <sub>2</sub> O
<b>Adjustable Range of Motion:</b>	330 ±10 degrees
<b>Tactile Knob Indication:</b>	30 cmH <sub>2</sub> O and above
<b>Minimum pressure to open the APL valve:</b>	Dry: 0.15 kPa Wet: 0.15 kPa

**TABLE 9-17** APL Valve

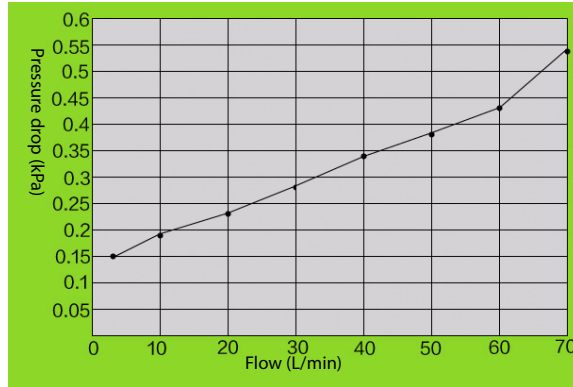
---

**Resistance of APL valve in dry gas:**

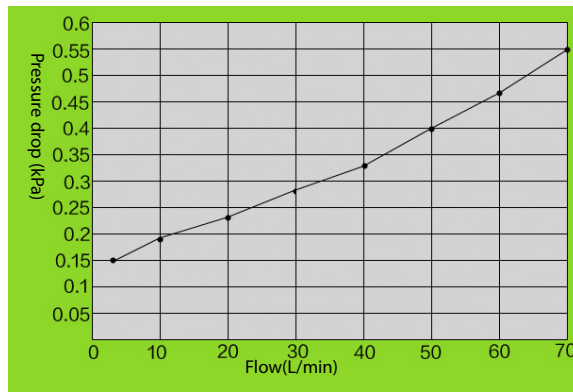
---

**Resistance of APL valve in wet gas:****TABLE 9-17** APL Valve

**Resistance of APL valve in dry gas (Lift the APL Valv):**



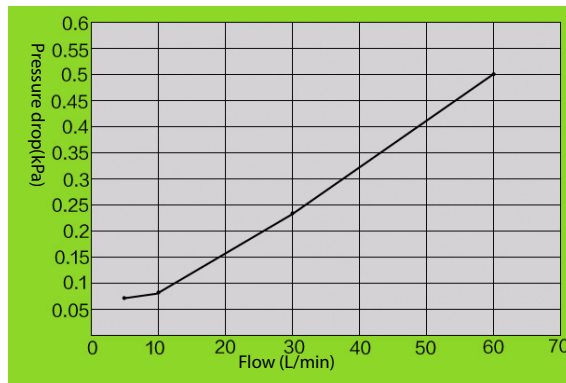
**Resistance of APL valve in wet gas (Lift the APL Valv):**



**TABLE 9-17** APL Valve

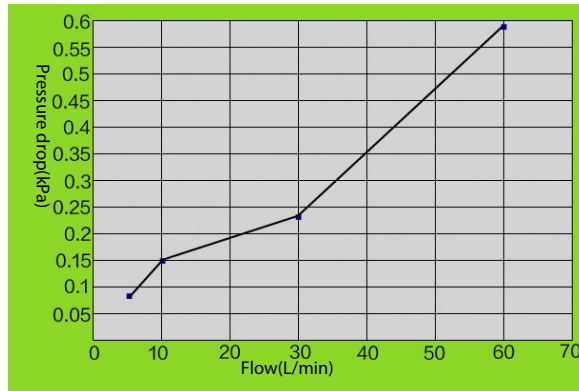
## 9.8.6 Resistance

**Expiratory resistance in mechanical ventilation mode:**

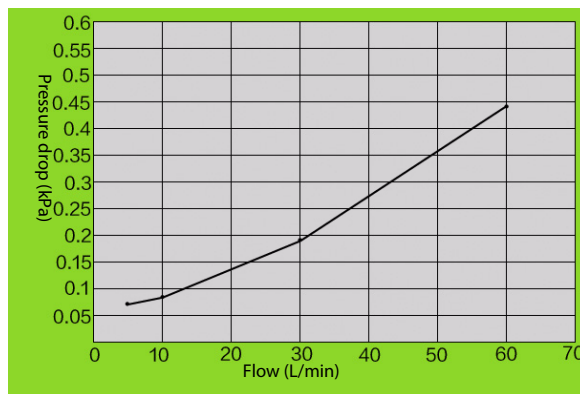


**TABLE 9-18** Resistance

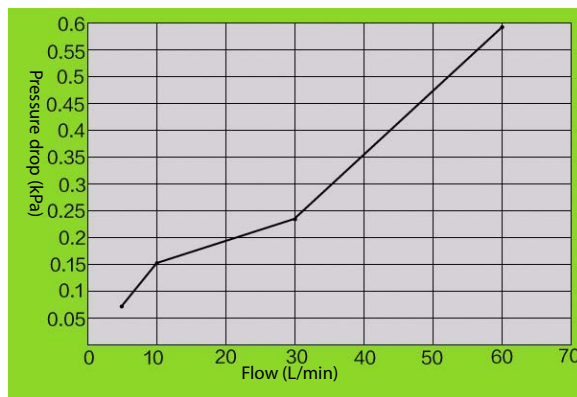
**Inspiratory resistance in mechanical ventilation mode:**



**Expiratory resistance in manual mode:**



**Inspiratory resistance in manual mode:**



**TABLE 9-18** Resistance



## 9.8.7 Breathing System Temperature Controller

<b>Breathing System Temperature Maintained to:</b>	35°C typical at 20°C ambient temperature
--	--

*Note: The block heater does not operate while the system is being powered by the internal battery supply.*

**TABLE 9-19** Breathing System Temperature Controller

## 9.8.8 Breathing Circuit Parameters

<b>System Compliance:</b>	Volume of gas lost due to internal compliance (manual ventilation mode (bag) only): ≤ 2 ml/cm H <sub>2</sub> O
<b>Internal Compliance:</b>	≤ 4 ml/cm H <sub>2</sub> O
<b>Impedance in Manual Mode:</b>	≤ 6 cmH <sub>2</sub> O (the gas under test is a bi-directional sine wave at a frequency of 20 with tidal volume of 1 L)
<b>Impedance in Automatic Ventilation Mode:</b>	≤ 6 cmH <sub>2</sub> O (the gas under test is a semi-sine wave at a frequency of 20 with tidal volume of 1 L)
<b>Leakage:</b>	≤ 150 ml @ 3 kPa
<b>System Safety Pressure on Patient Circuit:</b>	110 ± 10 cmH <sub>2</sub> O @ 10 to 110 L/min

**TABLE 9-20** Breathing Circuit Parameters

## 9.8.9 Materials

All materials in contact with the patient's exhaled gas are autoclavable, except the flow sensors and pressure gauge. All materials in contact with the patient's gas comply with ISO 10993-1, ISO 10993-5, ISO 10993-10.

# 9.9 Anesthetic Gas Scavenging System (AGSS)

<b>Type of the Applicable Disposable System:</b>	Low flow
<b>Size:</b>	430 mm x 132 mm x 114 mm Tolerance: +/- 5 mm
<b>Weight</b>	2.15 kg +/- 0.05 kg
<b>Extract Flow:</b>	25 to 50 L/min
<b>Resistance:</b>	≤ 0.35 kPa @ 75 L/min

**TABLE 9-21** Anesthetic Gas Scavenging System (AGSS)

## 9.10 Suction device

<b>Performance category:</b>	Pharyngeal Suction
<b>Supply</b>	External vacuum
<b>Maximum vacuum</b>	517.5 mmHg to 540 mmHg (69 kPa to 72 kPa) with external vacuum applied of 540 mmHg and 40 L/min free flow
<b>Maximum Flow</b>	39 L/min to 40 L/min with external vacuum applied of 540 mmHg and 40 L/min free flow

**TABLE 9-22** Suction device

Minimum Flow	20 L/min suction
Vacuum Gauge Accuracy	+/- 5 % of full scale

**TABLE 9-22** Suction device

## 9.11 Monitor Module

### 9.11.1 AG Module

<b>Measurement mode:</b>	Sidestream
<b>Warm-up time:</b>	ISO accuracy mode: < 45 s Full accuracy mode: <10 min
<b>Sampling rate:</b>	Sampling rate: The type of AG Watertrap is high volume: 120/150/200 ml/min The type of AG Watertrap is low volume: 70/90/120 ml/min Accuracy: $\pm 10$ ml/min or $\pm 10$ %, whichever is greater
<b>Watertrap emptying interval (half full, worst case):</b>	The type of AG Watertrap is high volume: 17 h @ 200 ml/min, 37 °C, 100 % RH The type of AG Watertrap is low volume: 20 h @ 120ml/min, 37 °C, 100 % RH
<b>Gas:</b>	CO <sub>2</sub> , O <sub>2</sub> (Paramagnetic O <sub>2</sub> module), N <sub>2</sub> O, and any of the five anesthetic agents: DES, ISO, ENF, SEV and HAL.
<b>Range:</b>	CO <sub>2</sub> : 0 to 30 % O <sub>2</sub> : 0 to 100 % N <sub>2</sub> O : 0 to 100 % DES : 0 to 30 % SEV : 0 to 30 % ENF : 0 to 30 % ISO : 0 to 30 % HAL : 0 to 30 %
<b>ISO accuracy mode</b>	As Full accuracy specifications, but derated as follows: Add $\pm 0.3$ % <sub>ABS</sub> to accuracy for CO <sub>2</sub> ; Add $\pm 8$ % <sub>REL</sub> to accuracy for all agents; N <sub>2</sub> O accuracy is $\pm (8$ % <sub>REL</sub> + 2 % <sub>ABS</sub> ).

1): 10 % to 90 %. Sample gas flow: 200 ml/min. DRYLINE™ watertrap. Adult DRYLINE™ sampling line (2.5 m).

2): 10 % to 90 %. Sample gas flow: 120 ml/min. DRYLINE™ watertrap. Pediatric DRYLINE™ sampling line (2.5 m).

**TABLE 9-23** AG Module

Full accuracy mode	Gas	Range (%REL)	Accuracy (%ABS)
	CO <sub>2</sub>	0 to 1	± 0.1
		1 to 5	± 0.2
		5 to 7	± 0.3
		7 to 10	± 0.5
		> 10	Unspecified
	N <sub>2</sub> O	0 to 20	± 2
		20 to 100	± 3
	O <sub>2</sub>	0 to 25	± 1
		25 to 80	± 2
		80 to 100	± 3
	DES	0 to 1	± 0.15
		1 to 5	± 0.2
		5 to 10	± 0.4
		10 to 15	± 0.6
		15 to 18	± 1
	SEV	0 to 1	± 0.15
		1 to 5	± 0.2
		5 to 8	± 0.4
		> 8	Unspecified
	ENF, ISO, HAL	0 to 1	± 0.15
		1 to 5	± 0.2
		> 5	Unspecified
Rise time @ 200 ml/min <sup>1)</sup>	CO <sub>2</sub> : ≤ 250 ms		
	O <sub>2</sub> : ≤ 500 ms		
	N <sub>2</sub> O : ≤ 250 ms		
	ENF : ≤ 350 ms		
	DES, SEV, ISO, HAL: ≤ 300 ms		
Rise time @ 120 ml/min <sup>2)</sup>	CO <sub>2</sub> : ≤ 250 ms		
	O <sub>2</sub> : ≤ 500 ms		
	N <sub>2</sub> O : ≤ 250 ms		
	ENF : ≤ 350 ms		
	DES, SEV, ISO, HAL: ≤ 300 ms		
Delay time	< 4 s		
Update time	Once per second		
Calibration	Once per year		
Primary agent ID threshold	0.15 % (0.4 % during ISO accuracy mode)		
Secondary agent ID threshold	0.3 % (0.5 % during ISO accuracy mode) or 5 % <sub>REL</sub> (10 % <sub>REL</sub> for Isoflurane) of primary agent if primary agent >10 %		
Agent ID time	Less than 3 breaths, typically 12 seconds		

1): 10 % to 90 %. Sample gas flow: 200 ml/min. DRYLINE™ watertrap. Adult DRYLINE™ sampling line (2.5 m).

2): 10 % to 90 %. Sample gas flow: 120 ml/min. DRYLINE™ watertrap. Pediatric DRYLINE™ sampling line (2.5 m).

**TABLE 9-23** AG Module

Measurement accuracy drift	Meets accuracy requirements within 6 hours
Rate measurement	Measurement range: 2 rpm to 100 rpm Resolution: 1 rpm Measurement accuracy: 2 rpm to 60 rpm: $\pm 1$ rpm 60 rpm to 100 rpm: $\pm 2$ rpm

1): 10 % to 90 %. Sample gas flow: 200 ml/min. DRYLINE™ watertrap. Adult DRYLINE™ sampling line (2.5 m).

2): 10 % to 90 %. Sample gas flow: 120 ml/min. DRYLINE™ watertrap. Pediatric DRYLINE™ sampling line (2.5 m).

**TABLE 9-23** AG Module

**NOTE:** Inaccuracy specifications are affected by the breath rate and I:E change. The end-tidal gas reading is within specification for breath rate below 15BPM and I:E ratio smaller than 1:1 relative to the gas readings without breath; Add  $\pm 6\%$ REL to inaccuracy for HAL and O2 for breath rate larger than 15 BPM; Add  $\pm 6\%$ REL to inaccuracy for all gases for breath rate larger than 30 BPM (inaccuracy for HAL and O2 are unspecified in this case); inaccuracy is unspecified for breath rate larger than 60 BPM.

**NOTE:** The ability to properly resolve end-tidal values can be measured by using the set-up described in ISO 80601-2-55:2011 figure 201.101. In short, the method consists of sampling gas from two different sources connected to an electrically controlled pneumatic valve to permit rapid switching between the two sources. During the test, the valve is set to switch gas source at a number of frequencies (simulating the range of specified breath rates) and for each frequency the end-tidal value presented by the gas analyzer is noted. From a diagram of end-tidal value over frequency, the frequency at which the gas analyzer is no longer able to resolve end-tidal values according to specification is identified. This ability to properly resolve end-tidal values is listed in the corresponding AION? Multigas Analyzer technical specification.

**NOTE:** Data sample rate 25 Hz. Data presentation is 50 Hz, every second data point is interpolated.

**NOTE:** Inspiratory and end tidal CO2 concentration readings are identified by AION? Platinum Multigas Analyzers using the lowest and highest values respectively of the temporal CO2-curve. Corresponding readings of N2O and anesthetic agents are taken at the same point in time. Inspiratory and end-tidal O2 concentration readings are identified by the O2 mean value during the respiratory phase as identified by the temporal CO2 curve. Once correctly identified, the highest and lowest O2 concentration readings during each part of the phase will be presented as inspiratory and end-tidal O2 respectively.

## 9.11.2 Alarms

AG Alarm Limits	Range	Step	Unit
EtCO <sub>2</sub> High Limit	Off, 2 to 99	1	mmHg (% and kPa should be optional)
EtCO <sub>2</sub> Low Limit	Off, 0 to 97		
FiCO <sub>2</sub> High Limit	Off, 1 to 99		
EtN <sub>2</sub> O High Limit	Off, 2 to 100	1	%
EtN <sub>2</sub> O Low Limit	Off, 0 to 98		
FiN <sub>2</sub> O High Limit	Off, 2 to 100		
FiN <sub>2</sub> O Low Limit	Off, 0 to 98		

**TABLE 9-24** Alarms

EtHal High Limit	Off, 0.2 to 5.0	0.1	%
EtHal Low Limit	Off, 0.0 to 4.8		
FiHal High Limit	Off, 0.2 to 5.0		
FiHal Low Limit	Off, 0.0 to 4.8		
EtEnf High Limit	Off, 0.2 to 5.0	0.1	%
EtEnf Low Limit	Off, 0.0 to 4.8		
FiEnf High Limit	Off, 0.2 to 5.0		
FiEnf Low Limit	Off, 0.0 to 4.8		
EtIso High Limit	Off, 0.2 to 5.0	0.1	%
EtIso Low Limit	Off, 0.0 to 4.8		
FiIso High Limit	Off, 0.2 to 5.0		
FiIso Low Limit	Off, 0.0 to 4.8		
EtSev High Limit	Off, 0.2 to 8.0	0.1	%
EtSev Low Limit	Off, 0.0 to 7.8		
FiSev High Limit	Off, 0.2 to 8.0		
FiSev Low Limit	Off, 0.0 to 7.8		
EtDes High Limit	Off, 0.2 to 18.0	0.1	%
EtDes Low Limit	Off, 0.0 to 17.8		
FiDes High Limit	Off, 0.2 to 18.0		
FiDes Low Limit	Off, 0.0 to 17.8		
Multiple halogenated Anesthesia agents value < 3 MAC		Low priority	
Multiple halogenated Anesthesia agents value > 3 MAC		Medium priority	

TABLE 9-24 Alarms

### 9.11.3 Effect of Interfering Gas on AG Measured Value

Gas Contaminants	Quantitative effect (% <sub>ABS</sub> ) <sup>3)</sup>			
	CO <sub>2</sub>	N <sub>2</sub> O	Agents <sup>1)</sup>	O <sub>2</sub>
CO <sub>2</sub>	0	0.1	0.1	0.2
N <sub>2</sub> O	0.1	0	0.1	0.2
Agents <sup>1) 2)</sup>	0	0.1	0.1 <sup>4)</sup>	1.0
<100 % Xenon	0.1	0	0	0.5
<50 % Helium	0.1	0	0	0.5
<0.1 % Ethanol	0	0	0	0.5
<1 % Acetone	0.1	0.1	0	0.5
<1 % Methane	0.1	0.1	0	0.5
Saturated Isopropanol vapor	0.1	0	0	0.5
Metered dose inhaler propellants	Unspecified	Unspecified	Unspecified	0.5

1) Agents represents one of DES, ISO, ENF, SEV, and HAL.

2) Multiple agent interference on CO<sub>2</sub>, N<sub>2</sub>O and O<sub>2</sub> is typically the same as single agent interference.

3) For CO<sub>2</sub>, N<sub>2</sub>O and Agents, maximum interference from each gas at concentrations within specified accuracy ranges for each gas. The total interference of all gases is never larger than 5%<sub>REL</sub>.

4) Interference for one of the five agents with secondary agent.

TABLE 9-25 Effect of Interfering Gas on AG Measured Value

### 9.11.4 Monitor Mode

The system supports **Monitor** mode when the A7 is configured with an external AG module.

When the system is in **Monitor** mode, the external AG module continues to function, while the ventilation monitors and alarms of the A7 will be off.

### 9.11.5 Agent Consumption Calculation and Agent Consumption Speed

Agent Consumption Calculation	
Calculation range:	0 to 3000 ml
Accuracy:	± 2 ml, or ± 25 % of the displayed value, whichever is greater.
Agent Consumption Speed	
Anesthetic agents	Desflurane, Enflurane, Isoflurane, Sevoflurane and Halothane
Consumption speed range	Desflurane: 0 to 900 ml/h Sevoflurane: 0 to 450 ml/h Enflurane, Isoflurane and Halothane: 0 to 250 ml/h
Accuracy	± 2ml/h or ±25% of the displayed value, whichever is greater.

**TABLE 9-26** Agent Consumption Calculation and Agent Consumption Speed

## 9.12 Ventilator Specifications

General Ventilator Specifications	
Ventilation Modes:	<ul style="list-style-type: none"> <li>• Manual ventilation mode with breathing bag</li> <li>• Spontaneous ventilation in manual mode with APL fully open</li> <li>• Volume Control Ventilation (VCV) mode with PLV function</li> <li>• Pressure Control Ventilation (PCV) mode with/without VG ventilation mode</li> <li>• Pressure Support (PS) ventilation mode</li> <li>• Synchronous Intermittent Mandatory Ventilation (SIMV) mode with VCV ventilation mode</li> <li>• Synchronous Intermittent Mandatory Ventilation (SIMV) mode with PCV ventilation mode</li> </ul>
Patient Size:	Adult, Pediatric, Infant
Fresh Gas Flow Compensation:	Volume-compensated ventilation
Inspiratory Flow (Min/Max):	The A7 does not allow combinations of ventilation parameters (e.g., I: E, Vt and Freq.) to be set if the resultant inspiratory flow is greater than 110 L/m maximum or less than 2.4 L/min minimum.
Inspiratory Flow Range:	2.4 to 110 L/min
Low Flow Anesthesia:	The accuracy of the tidal volume delivery shall be within the specification at 0.2 to 1 LPM total fresh gas flow.
Trigger Window:	PS and SIMV are adjustable flow triggers.
Inspiratory Trigger Level:	1 to 15 L/min
Plateau (End Insp.):	Plateau pressure in VCV and SIMV-VC mode. Adjustable from Off, 5 to 60 % of inspiratory period.

**TABLE 9-27** General Ventilator Specifications

Ventilator Parameter Settings Range	
Apnea Ti:	0.2 to 5.0 sec (PS), Step: 0.1 sec
Tidal Volume:	20 to 1500 ml (VCV, SIMV-VC), Step: 1 ml
Respiration Rate:	4 to 100 bpm (VCV, SIMV-VC, PCV, SIMV-PC), Step: 1 bpm
Minimum Rate:	2 to 60 bpm (PS), Step: 1 bpm
I:E	4:1 to 1:8 (VCV, PCV), Step: 0.5
Tinsp:	0.2 to 5 sec (SIMV-PC, SIMV-VC), Step: 0.1 sec
Pinsp:	5 to 70 cmH <sub>2</sub> O (PCV, SIMV-PC), Step: 1 cmH <sub>2</sub> O 5 to 1500 ml volume delivery
Tpause:	OFF, 5 to 60 % (VCV, SIMV-VC), Step: 1 %
Plimit:	10 to 100 cmH <sub>2</sub> O (VCV, SIMV-VC), Step: 1 cmH <sub>2</sub> O
PEEP:	OFF, 3 to 30 cmH <sub>2</sub> O (VCV, SIMV-VC, PCV, SIMV-PC, PS), Step: 1 cmH <sub>2</sub> O
ΔP:	3 to 50 cmH <sub>2</sub> O (SIMV-VC, SIMV-PC, PS), Step: 1 cmH <sub>2</sub> O
Trigger:	1 to 15 L/min (SIMV-VC, SIMV-PC, PS), Step: 1 L/min
Tslope:	0.0 to 2.0 sec (SIMV-VC, SIMV-PC, PCV, PS), Step: 0.1 sec
VtG	Off, 20 to 1500 ml (PCV), Step: 1
PlimVG	5 to 100 cmH <sub>2</sub> O (PCV), Step: 1 cmH <sub>2</sub> O

TABLE 9-28 Ventilator Parameter Settings Range

Ventilator Performance	
Drive Pressure:	280 to 600 kPa
Inspiratory flow range:	2.4 to 110 L/min

TABLE 9-29 Ventilator Performance

Ventilator Monitored Parameters	
Pressure Monitor:	PEEP range: 0 to 70 cmH <sub>2</sub> O Pmean range: -20 to 120 cmH <sub>2</sub> O Ppeak range: -20 to 120 cmH <sub>2</sub> O Pplateau range: -20 to 120 cmH <sub>2</sub> O
Ventilator Monitor:	Tidal Volume Range: 0 to 3000 ml Minute Volume Range: 0 to 100 L/min
Respiration Monitor:	Rate range: 0 to 120 bpm

TABLE 9-30 Ventilator Monitored Parameters

Control and Monitoring Accuracy *	
Volume Control Accuracy:	< 60 ml: ± 10 ml ≥ 60 ml and ≤ 210 ml: ± 15 ml > 210 ml: ± 7 % of the set value
Pressure Control Accuracy:	Pinsp: ± 2.5 cmH <sub>2</sub> O or ± 7 % of the set value, whichever is greater Plimit: ± 10 % of the set value

TABLE 9-31 Control and Monitoring Accuracy

<b>PEEP Control:</b>	3 to 30 cmH <sub>2</sub> O: $\pm 2.0$ cmH <sub>2</sub> O, or $\pm 10\%$ of the displayed value, whichever is greater OFF: not defined
<b>Respiration Control :</b>	$\pm 1$ bpm or $\pm 10\%$ of the set value, whichever is smaller
<b>Volume Monitoring:</b>	< 60 ml $\pm 10$ ml $\geq 60$ ml and $\leq 210$ ml $\pm 18$ ml > 210 ml $\pm 9\%$ of the set value
<b>Airway Pressure Monitoring:</b>	$\pm 2.0$ cmH <sub>2</sub> O or $\pm 5\%$ of the set value, whichever is greater
<b>PEEP Monitoring Accuracy</b>	0 to 30 cmH <sub>2</sub> O: $\pm 2.0$ cmH <sub>2</sub> O, or $\pm 10\%$ of the displayed value, whichever is greater > 30 cmH <sub>2</sub> O: not defined
<b>Respiration Monitoring Accuracy:</b>	$\pm 1$ bpm or $\pm 10\%$ of the set value, whichever is smaller
<b>Minute Volume Monitoring Accuracy:</b>	0 to 30 L/min $\pm 15\%$ of the displayed value, repeatable to $\pm 5\%$ over a 1 hour period

\* Specifications are applicable after warm-up time of the Breathing System (Section 9.8.6).

TABLE 9-31 Control and Monitoring Accuracy

## 9.13 Displays and Controls Specifications

### 9.13.1 Electronic Controls

<b>Display:</b>	Color LCD is 15 inch diagonal, 4:3 ratio, 1024 * 768 resolution TFT technology with touch screen
<b>Graphic Waveforms:</b>	Airway Pressure, Flow, Volume and CO <sub>2</sub> waveforms
<b>Numeric Data:</b>	Tidal Volume, Minute Volume, Peak airway pressure, PEEP, Mean or Plateau pressure, Breath Rate, FiO <sub>2</sub>
<b>AC Power Indicator LED:</b>	Green illuminated = plugged active AC power line Not illuminated = unplugged or inactive AC power line
<b>Battery State Indicator (LED):</b>	Solid green illuminated = battery supply is charging or fully charged Not illuminated = battery supply is discharging or not charging
<b>Vaporizer/Work Light:</b>	Settings: Off, Low, High
<b>System Switch:</b>	ON position = power applied to unit, O <sub>2</sub> fresh gas flow available Power Standby position = power applied only to charge battery supply, O <sub>2</sub> fresh gas flow not available
<b>NOTE: Flow of Air is independent of the system switch position.</b>	
<b>Touchpad :</b>	Allows control of the touch screen.
<b>Mouse:</b>	The A7 utilizes the USB port for a mouse that allows control of the touch screen.

TABLE 9-32 Electronic Controls



## 9.13.2 Pneumatic Controls

<b>Line Pressure Gauges:</b>	Gauges: N <sub>2</sub> O, Air, O <sub>2</sub> Range: 0 to 140 psi (0 to 1000 kPa) Accuracy: ± (4 % of full scale reading + 8 % of actual reading) Units of measure: kPa, psi
<b>Cylinder Pressure Gauges:</b>	Gauges: N <sub>2</sub> O, Air, O <sub>2</sub> N <sub>2</sub> O: 0 to 1400 psi (0 to 10 MPa) Air: 0 to 3500 psi (0 to 25 MPa) O <sub>2</sub> : 0 to 3500 psi (0 to 25 MPa) Accuracy: ± (4 % of full scale reading + 8 % of actual reading) Units of measure: kPa, psi
<b>Electronic mixer:</b>	Direct Flow Control Mode: O <sub>2</sub> flow range: 0 to 15 L/min Air flow range: 0 to 15 L/min N <sub>2</sub> O flow range: 0 to 12 L/min Electronic Encoders Rotations: < 4 (from minimum flow to maximum flow) O <sub>2</sub> flow accuracy: ± 50 ml/min or ± 5 % of setting value, whichever is greater Balance gas (Air/N <sub>2</sub> O) flow accuracy: ± 50 ml/min or ± 5 % of setting value, whichever is greater  Total Flow Control Mode: Total flow range: 0.2 to 18 L/min Total flow accuracy: ± 100 ml/min or ± 5 % of setting value, whichever is greater Leakage from one gas inlet to another gas inlet is less than 10 ml per hour.  O <sub>2</sub> concentration range: 21 % to 100 % (The balance gas is Air) 26 % to 100 % (The balance gas is N <sub>2</sub> O) O <sub>2</sub> concentration accuracy: ± 5 % V/V for flows < 1 L/min ± 5 % setting for flows ≥ 1 L/min  Compensation: Temperature and atmospheric pressure compensated to standard conditions of 20°C and 101.3 kPa (14.7 psi)
<b>Backup flow meter, Control Needle Valve and Knob:</b>	Control Range (O <sub>2</sub> ): 1+/-0.25 to 15 L/min Control Range (Air): 0 to 15 L/min Rotations: 3.5 to 4.5 (O <sub>2</sub> from minimum flow to maximum flow) 4 to 5 (Air from minimum flow to maximum flow)  Flow meter order (left to right, viewing front of unit): Air, O <sub>2</sub> .  Total flow meter range: 0 to 10 L/min Indicator: Flow tube Indicator accuracy: ± 10 % of the indicated value for flows (between 10 % and 100 % of full scale with oxygen)
<b>Auxiliary O<sub>2</sub> and Air Flow Meter:</b>	Flow range for each meter: 0 to 15 L/min Indicator accuracy of each meter: ± 10 % of the indicated value for flows (between 10 % and 100 % of full scale)

**TABLE 9-33** Pneumatic Controls

<b>Auxiliary O<sub>2</sub> Gas Power Outlet :</b>	Pressure range: 280 to 600 kPa Maximum flow: ≥ 90 L/min
<b>O<sub>2</sub> Flush Pushbutton (green):</b>	Flow rate: 35 to 50 L/min
<b>Inspiratory Airway Pressure Gauge:</b>	Range: -20 to 100 cmH <sub>2</sub> O Accuracy: ± (2 % of full scale reading + 4 % of actual reading)

**TABLE 9-33** Pneumatic Controls

## 9.14 Alarms

<b>Self-test:</b>	Self-testing of alarm system functions (alarm light, speaker, and buzzer) is performed when A7 System is powered on.
<b>Alarm Indicators:</b>	Audible: speaker / buzzer Visual: alarm light and on-screen alarm messages (Audible and visual alarms comply with the requirements of IEC 60601-1-8.)
<b>Alarm Categories:</b>	Physiological alarms: three levels (high, medium, low) Technical alarms: three levels (high, medium, low)
<b>Sound Levels:</b>	10 alarm sound levels, adjustable (levels 1 to 10)
<b>Alarm Status:</b>	Normal Status: all alarms are functioning properly Silence Status: silenced alarms do not produce alarm audio; only new alarms produce alarm audio
<b>Sound Pressure levels (normal operation without alarm):</b>	≤ 60 dBA Measured from the patient's head location at 1 meter height, 1 meter from the front of the unit, and 1 meter to the left of the unit.

**TABLE 9-34** Alarms

## 9.15 Safety Specifications

<b>Vibration Test:</b> (ISO 80601-2-55:2011(E))	Frequency range: 10 to 2000 Hz ASD 10 to 100 Hz: 1.0 (m/s <sup>2</sup> )/Hz ASD 100 to 200 Hz: -3 dB/Octave ASD 200 to 2000 Hz: 0.5 (m/s <sup>2</sup> )/Hz Duration: 10 min per perpendicular axis (3 total)
<b>Shock Test:</b> (ISO 80601-2-55:2011(E))	Peak acceleration: 150 m/s <sup>2</sup> (15 g) Duration: 11 ms Pulse shape: half-sine Number of shocks: 3 shocks per direction per axis (18 total)
<b>Vibration test:</b> (IEC60068-2-6-2007)	Frequency range: 10 Hz to 500 Hz Crossover frequency: 58 Hz to 62 Hz Displacement/acceleration: 0.15 mm / 2 g Sweep cycle: 5 cycles / axis (3 axis total) Velocity: 1 oct/min
<b>Rough handling:</b>	Complies with the requirements of clause 15.3.5 in IEC 60601-1.
<b>Spillage and Harmful Ingress of Water:</b>	Complies with the requirements of clause 11.6.3 in IEC 60601-1 and also the requirements in IEC 60529 for protection against vertically falling water drops equipment (IPX1).
<b>Surface Temperature:</b>	Complies with the requirements of clauses 11.1 in IEC 60601-1.

**TABLE 9-35** Safety Specifications

<b>Mechanical Stability:</b>	Complies with the requirements of clause 9.4 in IEC 60601-1.
<b>Incompatibility with External Connectors:</b>	Complies with the requirements of clause 15.4 in IEC 60601-1.
<b>Enclosure Rigidity and Strength:</b>	Complies with the requirements of clauses 15.3.2, 15.3.3, 15.3.6, and 15.3.7 in IEC 60601-1.
<b>Impairment of Cooling:</b>	Complies with the requirements of clause 13.2.7 in IEC 60601-1.
<b>Leakage Current:</b>	Complies with the requirements of clause 8.7 in IEC 60601-1. Earth leakage current: • Normal condition $\leq 500 \mu\text{A}$ • Single fault condition $\leq 1000 \mu\text{A}$ Enclosure leakage current: • Normal condition $\leq 100 \mu\text{A}$ • Single fault condition $\leq 300 \mu\text{A}$ Patient leakage current: • Normal condition $\leq 100 \mu\text{A}$ • Single fault condition $\leq 500 \mu\text{A}$ Patient auxiliary current DC: • Normal condition $\leq 10 \mu\text{A}$ • Single fault condition $\leq 50 \mu\text{A}$ Patient auxiliary current AC: • Normal condition $\leq 100 \mu\text{A}$ • Single fault condition $\leq 500 \mu\text{A}$ Patient leakage current (applied part plus mains voltage): • Single fault condition $\leq 5000 \mu\text{A}$
<b>Dielectric Strength:</b>	Complies with the requirements of clause 8.8.3 in IEC 60601-1. Mains supply to earth (1MOOP): 1500 VRMS, 1 min Mains supply to applied part (2MOOP): 4000 VRMS, 1 min Applied part to earth (1MOOP): 1500 VRMS, 1 min Isolation at network port: 1500 VRMS, 1 min
<b>Grounding Impedance:</b>	Complies with the requirements of clause 8.6 in IEC 60601-1. The impedance between the protective earth terminal and any accessible metal part (e.g., screw and equipotential stud) that is protectively earthed does not exceed 0.1 ohm.
<b>Protective Grounding:</b>	Complies with the requirements of clause 8.6 in IEC 60601-1. The protective earth terminal is not used for the mechanical connection between different parts of the equipment or the fixing of any component not related to protective earthing or functional earthing.

TABLE 9-35 Safety Specifications

## 9.16 ASTM F 1208 – 89 (2005) Disclosures

Based on the following disclosures, the A7 complies with ASTM Standard Specification F1208 for Anesthesia Breathing Systems.

### 9.16.1 Leakage of Breathing System

Mode	Resistance	Pressure
Leakage (Manual mode, Bypass Off)	20.12 ml/min	@ 3 kPa

TABLE 9-36 Leakage of Breathing System

Leakage (Manual mode, Bypass On)	21.22 ml/min	@ 3 kPa
Leakage (Mechanical Ventilation mode, Bypass Off)	51.45 ml/min	@ 3 kPa
Leakage (Mechanical Ventilation mode, Bypass On)	19.22 ml/min	@ 3 kPa

**TABLE 9-36** Leakage of Breathing System

## 9.16.2 Resistance of Breathing Systems

The typical pressure drops due to inspiratory and expiratory gas flow in the breathing system at reference flows of 0.5 and 1.0 L/s are:

- Manual, Inspiratory flow: flow rate = 0.5 L/s @ 0.22 kPa resistance
- Manual, Inspiratory flow: flow rate = 1.0 L/s @ 0.59 kPa resistance
- Manual, Expiratory flow: flow rate = 0.5 L/s @ 0.19 kPa resistance
- Manual, Expiratory flow: flow rate = 1.0 L/s @ 0.44 kPa resistance
- Auto, Inspiratory flow: flow rate = 0.5 L/s @ 0.23 kPa resistance
- Auto, Inspiratory flow: flow rate = 1.0 L/s @ 0.59 kPa resistance
- Auto, Expiratory flow: flow rate = 0.5 L/s @ 0.50 kPa resistance
- Auto, Expiratory flow: flow rate = 1.0 L/s @ 0.23 kPa resistance

## 9.16.3 CO<sub>2</sub> Absorber Resistance

For a CO<sub>2</sub> absorber filled with pre-pack absorbent: resistance at 1 L/s flow = 0.13 kPa

For a CO<sub>2</sub> absorber filled with loosened absorbent: resistance at 1 L/s flow = 0.12 kPa

## 9.16.4 CO<sub>2</sub> Absorber Capacity

CO<sub>2</sub> absorber capacity is 1 Pre-Pak or 1500 ml.

## 9.16.5 Unidirectional Valve Opening Pressure

Dry: 0.02 kPa opening pressure

Wet: 0.02 kPa opening pressure.

# 9.17 Data Storage (Non-Volatile) and Recording

<b>Configuration Storage:</b>	A7 supports one factory configuration group and one user configuration group. Each configuration has three patient size types: Adult, Pediatric, and Infant.
<b>Log Storage:</b>	500 entries of alarm log 500 entries of activity log 500 entries of error log 500 entries of service log

**TABLE 9-37** Data Storage (Non-Volatile) and Recording

## 9.18 Response Time of the A7 to an Increase in O<sub>2</sub> Concentration (From 21% to 90%/100%)

Ventilator setting: TV=500 ml, Freq=10 bpm, I:E=1:2

Fresh Gas(L/min)	O <sub>2</sub> Flush	Response Time From 21% to 90%	Response Time From 21% to 100%
1.0	Without O <sub>2</sub> Flush	15 minutes	50 minutes
	With O <sub>2</sub> Flush	1 minute	2 minutes
5.0	Without O <sub>2</sub> Flush	2 minutes	6 minutes
	With O <sub>2</sub> Flush	1 minute	1 minute
10.0	Without O <sub>2</sub> Flush	1 minute	2 minutes
	With O <sub>2</sub> Flush	1 minute	1 minute

**TABLE 9-38** Response Time of the A7 to an Increase in O<sub>2</sub> Concentration (From 21% to 90%/100%)

## 9.19 Electromagnetic Compatibility

The A7 meets the requirements of IEC 60601-1-2 / EN 60601-1-2.

- NOTE:** Using accessories, sensors and cables other than those specified may result in increased electromagnetic emission or decreased electromagnetic immunity of the equipment.
- NOTE:** The anesthesia machine or its components should not be used adjacent to or stacked with other equipment. If adjacent or stacked use is necessary, the anesthesia machine or its components should be observed to verify normal operation in the configuration in which it will be used.
- NOTE:** The anesthesia machine needs special precautions regarding EMC and needs to be installed and put into service according to the EMC information provided below.
- NOTE:** Other devices may interfere with this equipment even though they meet the requirements of CISPR.
- NOTE:** When the input signal is below the minimum amplitude provided in technical specifications, erroneous measurements could result.
- NOTE:** Use of portable or mobile communications devices can degrade the performance of the equipment.

### **GUIDANCE AND DECLARATION - ELECTROMAGNETIC EMISSION**

The A7 is intended for use in the specified electromagnetic environment. The customer or the user of the A7 should assure that it is used in such an environment as described below.

<b>EMISSIONS TEST</b>	<b>COMPLIANCE</b>	<b>ELECTROMAGNETIC ENVIRONMENT - GUIDANCE</b>
Radio frequency (RF) emissions CISPR 11	Group 1	The A7 uses RF energy only for its internal function. Therefore, its RF emissions are very low and are not likely to cause any interference in nearby electronic equipment.
Radio frequency (RF) emissions CISPR 11	Class B	A7 is suitable for use in all establishments, including domestic establishments and those directly connected to the public low-voltage power supply network that supplies buildings used for domestic purposes.
Harmonic emissions IEC 61000-3-2	Not applicable	
Voltage fluctuations/ Flicker emissions IEC 61000-3-3	Not applicable	

**TABLE 9-39** Guidance and Declaration - Electromagnetic Emission

**GUIDANCE AND DECLARATION - ELECTROMAGNETIC IMMUNITY**

The A7 is intended for use in the specified electromagnetic environment. The customer or the user of the A7 should assure that it is used in such an environment as described below.


<b>IMMUNITY TEST</b>	<b>IEC 60601 TEST LEVEL</b>	<b>COMPLIANCE LEVEL</b>	<b>ELECTROMAGNETIC ENVIRONMENT - GUIDANCE</b>
Electrostatic discharge (ESD) IEC 61000-4-2	±6 kV contact ±8 kV air	±6 kV contact ±8 kV air	Floors should be wood, concrete or ceramic tile. If floors are covered with synthetic material, the relative humidity should be at least 30%.
Electrical fast transient/burst (EFT) IEC 61000-4-4	±2 kV for power supply lines ±1 kV for input/output lines (length≥3 m)	±2 kV for power supply lines ±1 kV for input/output lines (length≥3 m)	Mains power quality should be that of a typical commercial or hospital environment.
Surge IEC 61000-4-5	±1 kV line (s) to line(s) ±2 kV line (s) to earth	±1 kV line (s) to line(s) ±2 kV line (s) to earth	Mains power quality should be that of a typical commercial or hospital environment.
Voltage dips, short interruptions and voltage variations on power supply input lines IEC 61000-4-11	<5% $U_T$ (>95% dip in $U_T$ ) for 0.5 cycle 40% $U_T$ (60% dip in $U_T$ ) for 5 cycles 70% $U_T$ (30% dip in $U_T$ ) for 25 cycles <5% $U_T$ (>95% dip in $U_T$ ) for 5 sec	<5% $U_T$ (>95% dip in $U_T$ ) for 0.5 cycle 40% $U_T$ (60% dip in $U_T$ ) for 5 cycles 70% $U_T$ (30% dip in $U_T$ ) for 25 cycles <5% $U_T$ (>95% dip in $U_T$ ) for 5 sec	Mains power quality should be that of a typical commercial or hospital environment. If the user of A7 requires continued operation during power mains interruptions, it is recommended that the A7 be powered from an uninterruptible power supply (UPS) .
Power frequency (50/60 Hz) magnetic field IEC 61000-4-8	3 A/m	3 A/m	Power frequency magnetic fields should be at levels characteristic of a typical location in a typical commercial or hospital environment.

$U_T$  is the A.C. mains voltage prior to application of the test level.

**TABLE 9-40** Guidance and Declaration - Electromagnetic Immunity

**GUIDANCE AND DECLARATION - ELECTROMAGNETIC IMMUNITY**

The A7 is intended for use in the specified electromagnetic environment. The customer or the user of the A7 should assure that it is used in such an environment as described below.

IMMUNITY TEST	IEC 60601 TEST LEVEL	COMPLIANCE LEVEL	ELECTROMAGNETIC ENVIRONMENT - GUIDANCE
Conducted RF IEC 61000-4-6	3 Vrms 150 kHz to 80 MHz outside ISM bands <sup>a</sup>	3 Vrms	Portable and mobile RF communications equipment should be used no closer to any part of the system, including cables, than the recommended separation distance calculated from the equation appropriate to the frequency of the transmitter.  <b>Recommended separation distance</b> $d = 1.2 \times \sqrt{P}$
	10 Vrms 150 kHz to 80 MHz in ISM bands <sup>a</sup>	10 Vrms	
Radiated RF IEC 61000-4-3	10 V/m 80 MHz to 2.5 GHz	10 V/m	<b>Recommended separation distance</b> $d = 1.2 \times \sqrt{P}$ 80 MHz to 800 MHz  $d = 2.3 \times \sqrt{P}$ 800 MHz to 2.5 GHz  where $P$ is the maximum output power rating of the transmitter in watts (W) according to the transmitter manufacturer and $d$ is the recommended separation distance in meters (m) <sup>b</sup> .  Field strengths from fixed RF transmitters, as determined by an electromagnetic site survey <sup>c</sup> , should be less than the compliance level in each frequency range <sup>d</sup> . Interference may occur in the vicinity of equipment marked with the following symbol: 

**NOTE:** At 80 MHz and 800 MHz, the separation distance for the higher frequency range applies.

**NOTE:** These guidelines may not apply in all situations. Electromagnetic propagation is affected by absorption and reflection from structures, objects and people.

- a* The ISM (Industrial, Scientific and Medical) bands between 150 kHz and 80 MHz are 6,765 MHz to 6,795 MHz; 13,553 MHz to 13,567 MHz; 26,957 MHz to 27,283 MHz; and 40,66 MHz to 40,70 MHz.
- b* An additional factor of 10/3 is used in calculating the recommended separation distance for transmitters in the ISM frequency bands between 150 kHz and 80 MHz and in the frequency range 80 MHz to 2,5 GHz to decrease the likelihood that mobile/portable communications equipment could cause interference if it is inadvertently brought into patient areas.
- c* Field strengths from fixed transmitters, such as base stations for radio (cellular/cordless) telephones and land mobile radios, amateur radio, AM and FM radio broadcast and TV broadcast cannot be predicted theoretically with accuracy. To assess the electromagnetic environment due to fixed RF transmitters, an electromagnetic site survey should be considered. If the measured field strength in the location in which the A7 is used exceeds the applicable RF compliance level above, the A7 should be observed to verify normal operation. If abnormal performance is observed, additional measures may be necessary, such as reorienting or relocating A7.
- d* Over the frequency range 150 kHz to 80 MHz, field strengths should be less than 3 V/m.

**TABLE 9-41** Guidance and Declaration - Electromagnetic Immunity



**RECOMMENDED SEPARATION DISTANCES BETWEEN PORTABLE AND MOBILE RF COMMUNICATIONS EQUIPMENT AND THE A7**

The A7 is intended for use in an electromagnetic environment in which radiated RF disturbance are controlled. The customer or the user of the A7 can help prevent electromagnetic interference by maintaining a minimum distance between portable/mobile RF communications equipment (transmitters) and the A7 as recommended below, according to the maximum output power of the communications equipment.

RATED MAXIMUM OUTPUT POWER OF TRANSMITTER (W)	SEPARATION DISTANCE ACCORDING TO FREQUENCY OF TRANSMITTER m		
	150 kHz to 80 MHz	80 MHz to 800 MHz	800 MHz to 2.5 GHz
	$d = 1.2 \times \sqrt{P}$	$d = 1.2 \times \sqrt{P}$	$d = 2.3 \times \sqrt{P}$
0.01	0.12	0.12	0.23
0.1	0.38	0.38	0.73
1	1.2	1.2	2.3
10	3.8	3.8	7.3
100	12	12	23

For transmitters rated at a maximum output power not listed above, the recommended separation distance  $d$  in meters (m) can be determined using the equation applicable to the frequency of the transmitter, where  $P$  is the maximum output power rating of the transmitter in watts (W) according to the transmitter manufacturer.

**NOTE:** At 80 MHz and 800 MHz, the separation distance for the higher frequency range applies.

**NOTE:** An additional factor of 10/3 is used in calculating the recommended separation distance for transmitters in the ISM frequency bands between 150 kHz and 80 MHz and in the frequency range 80 MHz to 2,5 GHz to decrease the likelihood that mobile/portable communications equipment could cause interference if it is inadvertently brought into patient areas.

**NOTE:** These guidelines may not apply in all situations. Electromagnetic propagation is affected by absorption and reflection from structures, objects and people.

**TABLE 9-42** Recommended separation distances between portable and mobile RF communications equipment and the A7

ANESTHESIA SYSTEM'S ESSENTIAL PERFORMANCE		ESSENTIAL PERFORMANCE TESTED DURING EMC IMMUNITY TESTS	CRITERIA DURING EMC IMMUNITY
Oxygen flow under all conditions except the failure of the oxygen supply (pipeline or cylinder) to the anesthetic workstation or the generation of a technical alarm condition	Oxygen supply failure protection device	Oxygen supply failure protection device	No false O <sub>2</sub> supply failure alarm shall be activated and the fresh gas flow shall be maintained when the O <sub>2</sub> supply pressure is within the rated input pressure range.
	Interruption of the electrical power supply	Power management	The anesthesia system can run on AC power supply and battery supply, and <ol style="list-style-type: none"> <li>1. Battery in Use alarm of low priority will be indicated only in case of AC power supply failure.</li> <li>2. The ventilation will be maintained, and the control and monitoring accuracy shall meet the requirements of the specification.</li> <li>3. The fresh gas flow will be maintained, and the accuracy will meet the requirements of the specification.</li> </ol>
Delivery of a non-hypoxic gas mixture to the patient or generation of a technical alarm condition	Internal electrical power source	Battery power supply	The residual capacity of battery power can be indicated normally when battery power works.
	Protection against hazardous output	Control and monitoring accuracy	Control accuracy: Tidal volume: 50 ± 10 ml Breath rate: 40 ± 1 bpm Monitoring accuracy: Tidal volume: 50 ± 10 ml Breath rate: 40 ± 1 bpm Airway pressure: ± 2.0 cmH <sub>2</sub> O or ± 5 % of the measured value, whichever is greater
	Gas mixers	Gas mixers	Accuracy: 0.2 ± 0.1 L/min
Non-delivery of excessive concentrations of a volatile anesthetic agent or generation of a technical alarm condition	Anesthetic agent monitoring equipment	Anesthetic agent monitoring equipment	Accuracy (%): CO <sub>2</sub> : 5 ± 0.2 N <sub>2</sub> O: 45 ± 3 DES: 5 ± 0.2 O <sub>2</sub> : 45 ± 2

**TABLE 9-43** Anesthesia system's EMC essential performance

# Accessories

---

Accessory Kits.....	A-2
AG Accessories .....	A-2
CO2 Absorbent.....	A-2
Gas Cylinder Accessories.....	A-2
Gas Supply Hoses .....	A-3
Manuals and Reference Cards.....	A-3
Mounting Accessories .....	A-3
Networking and USB Storage .....	A-4
Vaporizers .....	A-4

- WARNING:** Use only accessories specified in this chapter. Using other accessories may cause incorrect measured values or equipment damage.
- WARNING:** Disposable accessories cannot be reused. Reuse may degrade performance or cause cross-contamination.
- WARNING:** Check the accessories and their packages for damage. Do not use them if any sign of damage is detected.
- WARNING:** At the end of its service life, dispose of the equipment, and its accessories in compliance with the guidelines regulating the disposal of such products, and in accordance with local regulations for contaminated and biologically hazardous items.

The following accessories are designed for the A7 Anesthesia System. The use of other accessories is not recommended. To place an order for these or other accessories, contact Customer Service at 1 (800)288-2121 or order accessories online at [www.mindray.com](http://www.mindray.com).

## A.1 Accessory Kits

PART NUMBER	DESCRIPTION
115-009546-00	A7 Kit, User Resource Kit

## A.2 AG Accessories

PART NUMBER	DESCRIPTION
040-002559-00	Watertrap (high volume, reusable)
040-002560-00	Watertrap (low volume, reusable)
040-002625-00	Sampling Line (high volume, disposable)
040-002624-00	Sampling Line (low volume, disposable)
9000-10-07486	Airway Adapter (straight, disposable)
9000-10-07487	Airway Adapter (elbow, disposable)
115-016575-00	A7 Multi Gas Module with Accessory Kit
115-016612-00	O <sub>2</sub> Port Cover Kit

## A.3 CO<sub>2</sub> Absorbent

PART NUMBER	DESCRIPTION
0683-00-0326-12	CO <sub>2</sub> Absorbent, Pre-Pak (12)

## A.4 Gas Cylinder Accessories

PART NUMBER	DESCRIPTION
0348-00-0185	Washer, Seal for Cylinder

## A.5 Gas Supply Hoses

PART NUMBER	DESCRIPTION (15 FOOT LENGTH)
0004-00-0077-11	O <sub>2</sub> Gas Supply Hose, 15 ft, Ohmeda
0004-00-0077-12	O <sub>2</sub> Gas Supply Hose, 15 ft, Chemetron
0004-00-0077-13	O <sub>2</sub> Gas Supply Hose, 15 ft, Puritan Bennett
0004-00-0077-14	O <sub>2</sub> Gas Supply Hose, 15 ft, DISS Female
0004-00-0078-11	N <sub>2</sub> O Gas Supply Hose, 15 ft, Ohmeda
0004-00-0078-12	N <sub>2</sub> O Gas Supply Hose, 15 ft, Chemetron
0004-00-0078-13	N <sub>2</sub> O Gas Supply Hose, 15 ft, Puritan Bennett
0004-00-0078-14	N <sub>2</sub> O Gas Supply Hose, 15 ft, DISS Female
0004-00-0079-11	Air Gas Supply Hose, 15 ft, Ohmeda
0004-00-0079-12	Air Gas Supply Hose, 15 ft, Chemetron
0004-00-0079-13	Air Gas Supply Hose, 15 ft, Puritan Bennett
0004-00-0079-14	Air Gas Supply Hose, 15 ft, DISS Female
0004-00-0080-13	VAC Gas Supply Hose, 15 ft, Ohmeda
0004-00-0080-14	VAC Gas Supply Hose, 15 ft, Chemetron
0004-00-0080-15	VAC Gas Supply Hose, 15 ft, Puritan Bennett
0004-00-0080-16	VAC Gas Supply Hose, 15 ft, DISS Female
0004-00-0081-11	EVAC Gas Supply Hose, 15 ft, Ohmeda
0004-00-0081-12	EVAC Gas Supply Hose, 15 ft, Chemetron
0004-00-0081-13	EVAC Gas Supply Hose, 15 ft, Puritan Bennett
0004-00-0081-14	EVAC Gas Supply Hose, 15 ft, DISS Female
0004-00-0081-31	EVAC DISS to VAC Ohmeda Gas Supply Hose, 15 ft
0004-00-0081-32	EVAC DISS to VAC Chemetron Gas Supply Hose, 15 ft
0004-00-0081-33	EVAC DISS to VAC Puritan Bennett Gas Supply Hose, 15 ft
0004-00-0081-34	EVAC DISS to VAC DISS Female Gas Supply Hose, 15 ft

## A.6 Manuals and Reference Cards

PART NUMBER	DESCRIPTION
046-004667-01	A7 Operations Manual (Hardcopy, English)
046-009638-00	Disinfection / Cleaning Card
801-0631-00081-00	A7 Pre-Operation Checklist (English)
801-0631-00082-00	A7 Auxiliary O <sub>2</sub> /Air Reference Card

## A.7 Mounting Accessories

PART NUMBER	DESCRIPTION
0436-00-0169	Monitor Mounting Arm, Pivot, 12"
0040-00-0452	Mounting Kit, Passport 12M / 17M, DPM6/7, T5 & T8 to GCX Mount Adapter Plate

PART NUMBER	DESCRIPTION
115-009637-00	Kit for SMR to A5/A3 without Hooks
0436-00-0198	Monitor Mounting Arm, Pivot, 16"
0436-00-0258	Utility Tray, Two Pivot, 24"
045-000250-00	Writing Surface Insert (for Utility Tray)
0436-00-0259	Mount, Suction Canister
050-000702-00	Mounting Adapter Plate with Cable Hooks
115-011304-00	Cable Management Kit
115-004003-00	Mounting Kit for Passport 17M / DPM7 Monitor (top mounting)
115-004004-00	Mounting Kit for Passport 12M / DPM6 Monitor (top mounting)
008-000468-00	CPU Mount 3-4.5"/7.6-11.4 cm wide
008-000468-01	CPU Mount 1.5-3"/3.8-7.6 cm wide
008-000468-02	CPU Mount 4.5-7"/11.4-17.8 cm wide
008-000468-03	CPU Mount 7-9.5"/17.8-24.1 cm wide
115-021015-00	Spring hook material package
034-000288-00	AIMS Mounting Arm
121-001111-00	A Series AIMS Mounting Ergotron kit (kit contents listed below)
045-000794-00	Ergotron AIMS Adjustable Mounting Bracket
045-000795-00	Ergotron AIMS Mounting Arm
115-017467-00	Ergotron Mounting System

## A.8 Networking and USB Storage

PART NUMBER	DESCRIPTION
0012-00-1274-01	CAT 5 Ethernet Cable, Patch, STP, 6' (1.83 m)
0012-00-1274-02	CAT 5 Ethernet Cable, Patch, STP, 25' (7.62 m)
0012-00-1392-05	CAT 5 Ethernet Cable, Crossover, STP, 3' (0.91 m)
0012-00-1392-06	CAT 5 Ethernet Cable, Crossover, STP, 6' (1.83 m)
0012-00-1392-07	CAT 5 Ethernet Cable, Crossover, STP, 10' (3.05 m)
0992-00-0297-01	USB Storage Device, 2 GB
0000-10-10751	USB Wired Mouse
0992-00-0297-03	USB Storage Device, 8 GB
0992-00-0297-04	USB Storage Device, 16 GB

## A.9 Vaporizers

PART NUMBER	DESCRIPTION
0992-00-0148	Sevoflurane Vaporizer with Quick Fill Adapter
0004-00-0100	Sevoflurane Quick Fill Bottle Adapter
0992-00-0149	Isoflurane Vaporizer with Fill Adapter
0004-00-0101	Isoflurane Fill Bottle Adapter
115-020218-00	Three vaporizer mount

PART NUMBER	DESCRIPTION
040-001997-00	Desflurane Vaporizer
115-025532-00	Mindray Sevoflurane Quik Filler Vaporizer
040-000067-00	Mindray Quik-Fil Drain Funnel Adaptor
115-026747-00	Mindray Quik-Fil filling adapter for sevoflurane
115-025535-00	Mindray Isoflurane Key Filler Vaporizer
040-002707-00	Mindray Key Filler Adaptor for Isoflurane

## A.10 Scavenging Accessories

PART NUMBER	DESCRIPTION
115-037548-00	Passive scavenging kit

The Dynamic Gas Scavenging System (DGSS) from Anesthetic Gas Reclamation is approved for use on the A7.

**NOTE:** The Active AGSS comes standard with the A7 system.

**This page intentionally left blank.**



## ***User Accessible Spare Parts***

---

Active AGSS .....	B-2
Breathing System .....	B-2
CO2 Absorbent Canister .....	B-2
Flow Sensor .....	B-2
Gas Cylinder Accessories .....	B-3
Negative Pressure Suction Device .....	B-3
Battery .....	B-3

The following spare parts are designed for the A7 Anesthesia System. The use of other spare parts is not recommended. To place an order for these or other spare parts, contact Customer Service at 1 (800)288-2121 or order spare parts online at [www.mindray.com](http://www.mindray.com).

## B.1 Active AGSS

PART NUMBER	DESCRIPTION
115-023175-00	Waste Gas Scavenger Assembly
801-0631-00074-00	AGSS Transfer Tube
115-015457-00	Waste Gas Hose for Gas module to Quick Release Fitting
115-026796-00	AGSS 3 ways connector assembly

## B.2 Breathing System

PART NUMBER	DESCRIPTION
801-0631-00054-00	Bellows Dome, A Series
0601-30-78968	Bellows Assembly, A Series
801-0631-00057-00	Insp/Exp Connector, A Series
801-0631-00059-00	Insp/Exp Connector Rotary Cap, A Series
801-0631-00058-00	Water Trap, A Series
801-0631-00061-00	Check valve dome, A Series
801-0631-00104-00	Check valve, A Series
115-017033-00	Bag Arm - Fixed Height, A Series
115-028041-00	Flexible Bag Arm, A Series
115-025563-00	Airway pressure gauge, A Series
801-0631-00062-00	APL valve, A Series
115-012263-00	Quick release APL valve
115-027250-00	Breathing system, A7

## B.3 CO<sub>2</sub> Absorbent Canister

PART NUMBER	DESCRIPTION
801-0631-00066-00	CO <sub>2</sub> Absorbent Canister, A Series
801-0631-00099-00	CO <sub>2</sub> Bypass Assembly, A Series
801-0631-00092-00	CO <sub>2</sub> Absorber Hose, A Series
801-0631-00100-00	CO <sub>2</sub> Absorber Base with Drain Valve, A Series

## B.4 Flow Sensor

PART NUMBER	DESCRIPTION
801-0631-00056-00	Expiratory Flow Sensor Assembly, A Series

---

<b>PART NUMBER</b>	<b>DESCRIPTION</b>
801-0631-00060-00	Inspiratory Flow Sensor Assembly, A Series
115-008264-00	Flow sensor kit

---

## **B.5 Gas Cylinder Accessories**

---

<b>PART NUMBER</b>	<b>DESCRIPTION</b>
115-033063-00	Gas Cylinder Wrench

---

## **B.6 Negative Pressure Suction Device**

---

<b>PART NUMBER</b>	<b>DESCRIPTION</b>
082-001327-00	Filter
115-033264-00	Negative pressure suction tube (including filters)

---

## **B.7 Battery**

---

<b>PART NUMBER</b>	<b>DESCRIPTION</b>
115-018012-00	Lithium-ion Battery

---

**This page intentionally left blank.**

## ***Parameters and Factory Defaults***

---

Waveform/Spirometry Tabs.....	C-2
Alarm Limits .....	C-2
Setup Menu.....	C-4
Alarm Volume .....	C-6
History.....	C-6
Date and Time .....	C-6
Demographics.....	C-7
Ventilation Modes .....	C-7
Linked Ventilation Parameter .....	C-11
Ventilation Parameter Relationships .....	C-13

## C.1 Waveform/Spirometry Tabs

OBJECT	RANGE	DEFAULT
<b>Waveform/Spirometry Tab</b>	Waveform tab, Spirometry tab	Waveform tab
<b>Spirometry Tab: Loop Type</b>	Pressure - Volume, Flow - Volume, Pressure- Flow	Pressure - Volume
<b>Spirometry Tab: Save Loop</b>	Reference, Baseline	Reference
<b>Spirometry Tab: Show Reference</b>	Off, Baseline, [time]	Off
<b>Spirometry Tab: Review Loops: Loop Type</b>	Pressure - Volume, Flow - Volume, Pressure- Flow	Pressure - Volume

## C.2 Alarm Limits

PARAMETER	RANGE	DEFAULT	UNIT
<b>PEAK High</b>	The greater of 10 and (PEAK Low+1) to 100 Step: 1	Adult: 50 Pediatric: 40 Infant: 40	cmH <sub>2</sub> O
<b>PEAK Low</b>	0 to the lesser of 70 and (PEAK High-1) Step: 1	Adult: 10 Pediatric: 8 Infant: 4	cmH <sub>2</sub> O
<b>MV High</b>	The greater of 0.2 and (MV Low+0.1) to 25 Step: 0.1	Adult: 12 Pediatric: 6 Infant: 6	L/min
<b>MV Low</b>	0 to the lesser of 20 and (MV High-1) Step: 0.1	Adult: 1 Pediatric: 1 Infant: 0.2	L/min
<b>FiO<sub>2</sub> High</b>	The greater of 21 and (FiO <sub>2</sub> Low+1) to 100, Off Step: 1	Off	%
<b>FiO<sub>2</sub> Low</b>	18 to the lesser of 98 and (FiO <sub>2</sub> High-1) Step: 1	18	%
<b>EtCO<sub>2</sub> High</b>	Off, 2 to 99 Step: 1	Adult: 50 mmHg Pediatric: 50 mmHg Infant: 45 mmHg	mmHg, % kPa
<b>EtCO<sub>2</sub> Low</b>	Off, 0 to 97 Step: 1	Adult: 25 mmHg Pediatric: 25 mmHg Infant: 30 mmHg	mmHg, % kPa
<b>FiCO<sub>2</sub> High</b>	Off, 1 to 99 Step: 1	4	%
<b>EtN<sub>2</sub>O High</b>	Off, (Low+2) to 100 Step: 1	55	%
<b>EtN<sub>2</sub>O Low</b>	Off, 0 to (High-2) Step: 1	0	%
<b>FiN<sub>2</sub>O High</b>	Off, (Low+2) to 100 Step: 1	53	%

PARAMETER	RANGE	DEFAULT	UNIT
<b>FiN<sub>2</sub>O Low</b>	Off, 0 to (High-2) Step: 1	0	%
<b>EtHal High</b>	Off, (Low+0.2) to 5.0 Step: 0.1	3	%
<b>EtHal Low</b>	Off, 0.0 to (High-0.2) Step: 0.1	0	%
<b>FiHal High</b>	Off, (Low+0.2) to 5.0 Step: 0.1	2	%
<b>FiHal Low</b>	Off, 0.0 to (High-0.2) Step: 0.1	0	%
<b>EtEnf High</b>	Off, (Low+0.2) to 5.0 Step: 0.1	3	%
<b>EtEnf Low</b>	Off, 0.0 to (High-0.2) Step: 0.1	0	%
<b>FiEnf High</b>	Off, (Low+0.2) to 5.0 Step: 0.1	2	%
<b>FiEnf Low</b>	Off, 0.0 to (High-0.2) Step: 0.1	0	%
<b>EtIso High</b>	Off, (Low+0.2) to 5.0 Step: 0.1	3	%
<b>EtIso Low</b>	Off, 0.0 to (High-0.2) Step: 0.1	0	%
<b>Filso High</b>	Off, (Low+0.2) to 5.0 Step: 0.1	2	%
<b>Filso Low</b>	Off, 0.0 to (High-0.2) Step: 0.1	0	%
<b>EtSev High</b>	Off, (Low+0.2) to 8.0 Step: 0.1	6	%
<b>EtSev Low</b>	Off, 0.0 to (High-0.2) Step: 0.1	0	%
<b>FiSev High</b>	Off, (Low+0.2) to 8.0 Step: 0	5	%
<b>FiSev Low</b>	Off, 0.0 to (High-0.2) Step: 0.1	0	%
<b>EtDes High</b>	Off, (Low+0.2) to 18.0 Step: 0.1	8	%
<b>EtDes Low</b>	Off, 0.0 to (High-0.2) Step: 0.1	0	%
<b>FiDes High</b>	Off, (Low+0.2) to 18.0 Step: 0.1	6	%
<b>FiDes Low</b>	Off, 0.0 to (High-0.2) Step: 0	0	%
<b>EtO<sub>2</sub> High</b>	Off, (Low+0.2) to 100 Step: 1	88	%
<b>EtO<sub>2</sub> Low</b>	Off, 10 to (High-2) Step: 1	Off	%
<b>CO<sub>2</sub> Apnea Delay Time</b>	10 sec, 15 sec, 20 sec, 25 sec, 30 sec, 35 sec, 40 sec	30	sec,

## C.3 Setup Menu

PARAMETER	RANGE	DEFAULT
<b>General Tab: Breathing System</b>	Warmer On, Warmer Off	Warmer On
<b>General Tab: Gas Bench Flow Rate</b>	Adult watertrap: Low (120 ml/min), Med (150ml/min), High (200 ml/min)  Infant watertrap: Low (70 ml/min), Med (90 ml/min), High (120 ml/min)	Low (120 ml/min)
<b>General Tab: Balance Gas</b>	AIR, N <sub>2</sub> O, None	AIR
<b>General Tab: Fresh Gas Control</b>	Total Flow, Direct Flow	Total Flow
<b>Display Tab: Pressure Display</b>	Mean, PLAT	PLAT
<b>Display Tab: P-limit Line</b>	On/Off	On
<b>Display Tab: Screen Brightness</b>	level 1-10	5
<b>Display Tab: Key Click Volume</b>	level 1-10	3
<b>Display Tab: CO<sub>2</sub> Placement</b>	Top, Bottom	Top
<b>Display Tab: CO<sub>2</sub> Scale</b>	0-40 mmHg, 0-60 mmHg, 0-80 mmHg	0-60 mmHg
<b>Display Tab: Waveform Display</b>	Volume, Flow	Flow
<b>System Tab: Language</b>	CHINESE, ENGLISH, FRENCH, SPANISH, PORTUGUESE, RUSSIAN, TURKISH, DUTCH	ENGLISH
<b>System Tab: Default Settings: Default Patient Size</b>	Adult, Pediatric, Infant	Infant
<b>System Tab: Default Settings: Default Vent Mode</b>	VCV, SIMV-VC, PCV, SIMV-PC, PS	VCV
<b>System Tab: Manage Defaults</b>	Save as O.R. Defaults, Load O.R. Defaults, Restore Partial Defaults, Import Defaults, Export Defaults	Save as O.R. Defaults
<b>System Tab: Change Password</b>	—	1234
<b>System Tab: Units: Pressure</b>	cmH <sub>2</sub> O, hPa, mbar	cmH <sub>2</sub> O
<b>System Tab: Units: CO<sub>2</sub></b>	mmHg, kPa, %	mmHg
<b>System Tab: Clear History</b>	On, Off	Off
<b>System Tab: Optimizer: Optimizer</b>	On, Off	On
<b>System Tab: Time Settings: Daylight Savings</b>	Manual, Auto	Manual
<b>System Tab: Network: This Machine: Configure Ethernet: IP Address</b>	0 - 255	192.168.23.250



PARAMETER	RANGE	DEFAULT
<b>System Tab: Network: This Machine: Configure Ethernet: Subnet</b>	0 - 255	255.255.255.0
<b>System Tab: Network: This Machine: Configure Ethernet: Default Gateway</b>	0 - 255	—
<b>System Tab: Network: This Machine: Configure Serial: Baud Rate</b>	57600, 115200	115200
<b>System Tab: Network: This Machine: Configure Serial: Parity</b>	Odd, Even, None	None
<b>System Tab: Network: This Machine: Configure Serial: Data Bits</b>	8	8
<b>System Tab: Network: This Machine: Configure Serial: Protocol</b>	None, HL7, MR-WATO, Philips	None
<b>System Tab: Network: This Machine: Configure Serial: Interval</b>	10 sec, 30 sec, 1 min, 5 min, 30 min, 1 hour, 2 hour, 6 hour, 12 hour, 24 hour	1 min
<b>System Tab: Network: This Machine: Configure Serial: Stop Bits</b>	1, 2	1
<b>System Tab: Network: Network Protocol: Configure HL7: Interval</b>	10 sec, 30 sec, 1 min, 5 min, 30 min, 1 hr, 2 hr, 6 hr, 12 hr, 24 hr	1 min
<b>System Tab: Network: Network Protocol: Configure HL7: Destination IP</b>	—	192.168.23.200
<b>System Tab: Network: Network Protocol: Configure HL7: Port</b>	0 - 65535	1550
<b>System Tab: Network: Network Protocol: Configure HL7: Set HL7 Compatibility</b>	Most Recent, 02.02.01 to 02.10.00, 02.00.00, 01.05.02, 01.00.00 to 01.05.01, None	Most Recent
<b>System Tab: Network: Network Protocol: Configure HL7: Send Waveforms</b>	On, Off	Off
<b>System Tab: Network: Network Protocol: Configure HL7: Send Alarms</b>	On, Off	Off
<b>System Tab: Network: Network Protocol: Configure HL7: Send Alarms Ack.</b>	On, Off	Off
<b>System Tab: Network: Network Protocol: MD2</b>	On, Off	Off
<b>System Tab: Network: Network Protocol: Configure MD2: Destination IP</b>	—	192.168.23.99
<b>System Tab: Network: Network Protocol: Configure MD2: Port</b>	—	6678

PARAMETER	RANGE	DEFAULT
<b>System Tab: Network: SNTP Protocol: Interval</b>	Off, 10 sec, 30 sec, 1 min, 5 min, 30 min, 1 hr, 2 hr, 6 hr, 12 hr, 24 hr	Off
<b>System Tab: Network: SNTP Protocol: Primary Server IP</b>	0 - 255	132.163.4.103
<b>System Tab: Network: SNTP Protocol: Secondary Server IP</b>	0 - 255	210.72.145.44

## C.4 Alarm Volume

PARAMETER	RANGE	DEFAULT
<b>Alarm Volume</b>	level 1-10	3
<b>System Alerts Volume</b>	level 1-10	3

## C.5 History

PARAMETER	RANGE	DEFAULT
<b>Display Interval</b>	1 Min, 5 Min, 10 Min, 15 Min, 30 Min, 1 Hour, 2 Hour	1 Min
<b>Display Group</b>	Gas, Fresh Gas, Ventilation, All	All
<b>Filter</b>	High, Medium, Low, Informational, All	All

## C.6 Date and Time

PARAMETER	RANGE	DEFAULT
<b>Day</b>	1-31	1
<b>Month</b>	1-12	1
<b>Year</b>	1900-2099	2009
<b>Hour</b>	—	00 (24 hr) 12 AM (12 hr)
<b>Minute</b>	00-60	00
<b>AM/PM</b>	AM/PM	AM
<b>12/24 hour</b>	12, 24	12
<b>Date format</b>	YYYY/MM/DD, MM/DD/YYYY, DD/MM/YYYY	YYYY-MM-DD
<b>Daylight Savings Time</b>	On, Off	Off

## C.7 Demographics

PARAMETER	RANGE	DEFAULT
Patient ID	—	—
Bed	—	—
First Name	—	—
Room	—	—
Last Name	—	—
Point of Care	—	—
DOB	—	—
Age	—	—
Weight (Lbs.)	—	—
Facility	—	—

## C.8 Ventilation Modes

OBJECT	RANGE	DEFAULT
Ventilation Mode Tab	VCV, SIMV-VC, PCV, SIMV-PC, PS	VCV

VENTILATION MODE	PARAMETERS
Manual	Bypass, Alarms, Monitor (Optional), ACGO (Optional)
VCV	Vt, Rate, I:E, Tpause, PEEP, Plimit
SIMV-VC	Vt, Rate, Tinsp, Tpause, PEEP, Plimit, PS (On/Off), $\Delta P$ , Trigger, Tslope,
PCV	VtG, PlimVG, Pinsp, Rate, I:E, PEEP, Tslope
SIMV-PC	Pinsp, Rate, Tinsp, PS (On/Off), $\Delta P$ , Trigger, PEEP, Tslope
PS	Min Rate, $\Delta P$ , Trigger, PEEP, Tslope, Apnea Ti

PARAMETER	VCV	SIMV-VC	PCV	SIMV-PC	PS	MANUAL
<b>Vt</b>	Range: 20 to 1500 ml Step: 1  Defaults: Adult: 600 ml Pediatric: 120 ml Infant: 20 ml	Range: 20 to 1500 ml Step: 1  Defaults: Adult: 600 ml Pediatric: 120 ml Infant: 20 ml	—	—	—	—
<b>VtG</b>	—	—	Range: Off, 20 to 1500 ml Step: 1  Default: Off	—	—	—
<b>Rate</b>	Range: 4 to 100 bpm Step: 1 bpm  Defaults: Adult: 8 bpm Pediatric: 15 bpm Infant: 20 bpm	Range: 4 to 100 bpm Step: 1 bpm  Defaults: Adult: 8 bpm Pediatric: 15 bpm Infant: 20 bpm	Range: 4 to 100 bpm Step: 1 bpm  Defaults: Adult: 8 bpm Pediatric: 15 bpm Infant: 20 bpm	Range: 4 to 100 bpm Step: 1 bpm  Defaults: Adult: 8 bpm Pediatric: 15 bpm Infant: 20 bpm	—	—
<b>Min. Rate</b>	—	—	—	—	Range: 2 to 60 bpm Step: 1 bpm  Defaults: Adult: 4 bpm Pediatric: 6 bpm Infant: 12 bpm	—
<b>I:E</b>	Range: 4:1 to 1:8 Step: 0.5  Default: 1:2	—	Range: 4:1 to 1:8 Step: 0.5  Default: 1:2	—	—	—
<b>Tinsp</b>	—	Range: 0.2 to 5 sec Step: 0.1 sec  Defaults: Adult: 2.0 sec Pediatric: 1.0 sec Infant: 1.0 sec	—	Range: 0.2 to 5 sec Step: 0.1 sec  Defaults: Adult: 2.0 sec Pediatric: 1.0 sec Infant: 1.0 sec	—	—

PARAMETER	VCV	SIMV-VC	PCV	SIMV-PC	PS	MANUAL
<b>P<sub>insp</sub></b>	—	—	Range: PEEP+5 to 70 cmH <sub>2</sub> O Step: 1 cmH <sub>2</sub> O  Defaults: Adult: 15 cmH <sub>2</sub> O Pediatric: 10 cmH <sub>2</sub> O Infant: 10 cmH <sub>2</sub> O	Range: PEEP+5 to 70 cmH <sub>2</sub> O Step: 1 cmH <sub>2</sub> O  Defaults: Adult: 15 cmH <sub>2</sub> O Pediatric: 10 cmH <sub>2</sub> O Infant: 10 cmH <sub>2</sub> O	—	—
<b>T<sub>pause</sub></b>	Range: Off, 5% to 60% Step: 1%  Default: 10%	Range: Off, 5% to 60% Step: 1%  Default: 10%	—	—	—	—
<b>P<sub>limit</sub></b>	Range: 10 to 100 cmH <sub>2</sub> O Step: 1 cmH <sub>2</sub> O  Defaults: Adult: 50 cmH <sub>2</sub> O Pediatric: 40 cmH <sub>2</sub> O Infant: 20 cmH <sub>2</sub> O	Range: 10 to 100 cmH <sub>2</sub> O Step: 1 cmH <sub>2</sub> O  Defaults: Adult: 50 cmH <sub>2</sub> O Pediatric: 40 cmH <sub>2</sub> O Infant: 20 cmH <sub>2</sub> O	—	—	—	—
<b>P<sub>limVG</sub></b>	—	—	Range: 5 - 100 cmH <sub>2</sub> O Step: 1 cmH <sub>2</sub> O  Default: P <sub>insp</sub>	—	—	—
<b>PEEP</b>	Range: Off, 3 to 30 cmH <sub>2</sub> O Step: 1 cmH <sub>2</sub> O  Default: Off	Range: Off, 3 to 30 cmH <sub>2</sub> O Step: 1 cmH <sub>2</sub> O  Default: Off	Range: Off, 3 to 30 cmH <sub>2</sub> O Step: 1 cmH <sub>2</sub> O  Default: Off	Range: Off, 3 to 30 cmH <sub>2</sub> O Step: 1 cmH <sub>2</sub> O  Default: Off	Range: Off, 3 to 30 cmH <sub>2</sub> O Step: 1 cmH <sub>2</sub> O  Default: Off	—
<b>ΔP</b>	—	Range: 3 to 50 cmH <sub>2</sub> O Step: 1  Defaults: Adult: 8 cmH <sub>2</sub> O Pediatric: 5 cmH <sub>2</sub> O Infant: 5 cmH <sub>2</sub> O	—	Range: 3 to 50 cmH <sub>2</sub> O Step: 1  Defaults: Adult: 8 cmH <sub>2</sub> O Pediatric: 5 cmH <sub>2</sub> O Infant: 5 cmH <sub>2</sub> O	Range: 3 to 50 cmH <sub>2</sub> O Step: 1  Defaults: Adult: 8 cmH <sub>2</sub> O Pediatric: 5 cmH <sub>2</sub> O Infant: 5 cmH <sub>2</sub> O	—

PARAMETER	VCV	SIMV-VC	PCV	SIMV-PC	PS	MANUAL
<b>Trigger</b>	—	Range: 1 to 15 L/min Step: 1  Defaults: Adult: 3 L/min Pediatric: 2 L/min Infant: 2 L/min	—	Range: 1 to 15 L/min Step: 1  Defaults: Adult: 3 L/min Pediatric: 2 L/min Infant: 2 L/min	Range: 1 to 15 L/min Step: 1  Defaults: Adult: 3 L/min Pediatric: 2 L/min Infant: 2 L/min	—
<b>Tslope</b>	—	Range: 0.0 to 2.0 sec Step: 0.1 sec  Default: 0.2 sec	Range: 0.0 to 2.0 sec Step: 0.1 sec  Default: 0.2 sec	Range: 0.0 to 2.0 sec Step: 0.1 sec  Default: 0.2 sec	Range: 0.0 to 2.0 sec Step: 0.1 sec  Default: 0.2 sec	—
<b>PS</b>	—	Range: On, Off Step: —  Default: Off	—	Range: On, Off Step: —  Default: Off	—	—
<b>Bypass</b>	—	—	—	—	—	Range: On, Off Step: —  Default: Off
<b>Alarm</b>	—	—	—	—	—	Range: On, Off Step: —  Default: On
<b>Apnea Ti</b>	—	—	—	—	Range: 0.2 to 5.0 sec Step: 0.1 sec  Default: 5.0 sec (adult) 3.0 sec (Pediatric) 2.0 sec (Infant)	—
<b>Monitor</b>	—	—	—	—	—	Range: On, Off Step: —  Default: Off
<b>ACGO</b>	—	—	—	—	—	Range: On, Off Step: —  Default: Off

## C.9 Linked Ventilation Parameter

The table below lists how parameter values are affected when changing ventilation modes. For example, ventilation modes that share the same parameters may also share the same parameter values when changing from one ventilation mode to the other. Other parameters may have their values set differently when changing ventilation modes.

CURRENT VENTILATION MODE & PARAMETERS AFFECTED		PREVIOUS VENTILATION MODE				
		VCV	SIMV-VC	PCV	SIMV-PC	PS
VCV	Vt	—	*	Measured Vt or last value	*	*
	Rate	—	*	*	*	*
	I:E	—	*	*	*	*
	Tpause	—	*	*	*	*
	PEEP	—	*	*	*	*
	Plimit	—	*	*	*	*
SIMV-VC	Vt	*	—	Measured Vt or last value	*	*
	Rate	*	—	*	*	*
	Tinsp	*	—	*	*	*
	Tpause	*	—	*	*	*
	PEEP	*	—	*	*	*
	Plimit	*	—	*	*	*
	PS	*	—	*	*	PS = On
	$\Delta P$	*	—	*	*	*
	Trigger	*	—	*	*	*
	Tslope	*	—	*	*	*
PCV	VtG	*	*	—	*	*
	Pinsp	PLAT or 80% PEAK or last value	*	—	*	*
	Rate	*	*	—	*	*
	I:E	*	*	—	*	*
	PEEP	*	*	—	*	*
	PlimVG	If VtG=OFF, then Pinsp. If VtG is a value, then last value of PlimVG.	If VtG=OFF, then Pinsp. If VtG is a value, then last value of PlimVG.	—	If VtG=OFF, then Pinsp. If VtG is a value, then last value of PlimVG.	If VtG=OFF, then Pinsp. If VtG is a value, then last value of PlimVG.
	Tslope	*	*	—	*	*

\* The parameter value is shared between the previous and current ventilation modes.

CURRENT VENTILATION MODE & PARAMETERS AFFECTED		PREVIOUS VENTILATION MODE				
		VCV	SIMV-VC	PCV	SIMV-PC	PS
SIMV-PC	<b>P<sub>insp</sub></b>	PLAT or 80% PEAK or last value	*	*	—	*
	<b>Rate</b>	*	*	*	—	*
	<b>T<sub>insp</sub></b>	*	*	*	—	*
	<b>PS</b>	*	*	*	—	PS = On
	<b>ΔP</b>	*	*	*	—	*
	<b>Trigger</b>	*	*	*	—	*
	<b>PEEP</b>	*	*	*	—	*
	<b>T<sub>slope</sub></b>	*	*	*	—	*
PS	<b>Min Rate</b>	*	*	*	*	—
	<b>ΔP</b>	*	*	*	*	—
	<b>Trigger</b>	*	*	*	*	—
	<b>Peep</b>	*	*	*	*	—
	<b>T<sub>slope</sub></b>	*	*	*	*	—
	<b>Apnea Ti</b>	*	*	*	*	—

\* The parameter value is shared between the previous and current ventilation modes.



## C.10 Ventilation Parameter Relationships

VENTILATION MODE	Parameter	Parameter Relationship Equation (s)
VCV	Rate	$Rate \leq 300 \times \frac{I : E}{1 + I : E}$
		$Rate \leq 150 \times \frac{1}{1 + I : E}$
		$4 \leq Rate \leq 100$
	Vt	$Vt \leq 1833 \times \frac{60 \times \left( \frac{I : E}{1 + I : E} \right) * (1 - TP)}{Rate}$ $Vt \geq 20 \times \frac{60 \times \left( \frac{I : E}{1 + I : E} \right) (1 - TP)}{Rate}$
		$20 \leq Vt \leq 1500$
	Plimit	Plimit $\geq$ PEEP+5 10 $\leq$ Plimit $\leq$ 100
SIMV-VC	Rate	$Rate \leq \frac{60}{T_{insp} + 0.4}$
		$4 \leq Rate \leq 100$
	Vt	$20 \times T_{insp} (1 - TP) \leq Vt \leq 1833 \times T_{insp} (1 - TP)$
		$20 \leq Vt \leq 1500$
	$\Delta P$	$\Delta P \leq$ Plimit-PEEP $3 \leq \Delta P \leq 50$
	Plimit	Plimit $\geq$ PEEP+5 Plimit $\geq$ $\Delta P$ +PEEP 10 $\leq$ Plimit $\leq$ 100

VENTILATION MODE	Parameter	Parameter Relationship Equation (s)
PCV	Rate	$Rate \leq 300 \times \frac{I:E}{1+I:E}$
		$Rate \leq 150 \times \frac{1}{1+I:E}$
		$4 \leq Rate \leq 100$
	VtG	If VtG is not Off.
		$VtG \geq 20 \times \frac{60 \times \left( \frac{I:E}{1+I:E} \right)}{Rate}$ $VtG \leq 1833 \times \frac{60 \times \left( \frac{I:E}{1+I:E} \right)}{Rate}$
	$20 \leq Vt \leq 1500$	
Pinsp	Pinsp $\geq$ PEEP+5 5 $\leq$ Pinsp $\leq$ 70	
PlimVG	PlimVG $\geq$ PEEP+5 5 $\leq$ PlimVG $\leq$ 100	
SIMV-PC	Rate	$Rate \leq \frac{60}{T_{insp} + 0.4}$
		$4 \leq Rate \leq 100$
	Pinsp	Pinsp $\geq$ PEEP+5 5 $\leq$ Pinsp $\leq$ 70

**NOTE:** Even when the PlimVG, Pinsp, or  $\Delta P$  parameters are inactive, they are restricted to the parameter relationship equations.

---

D.0

# ***Pneumatic Diagram***

---

Pneumatic Diagram of the A7 System.....D-2

# D.1 Pneumatic Diagram of the A7 System

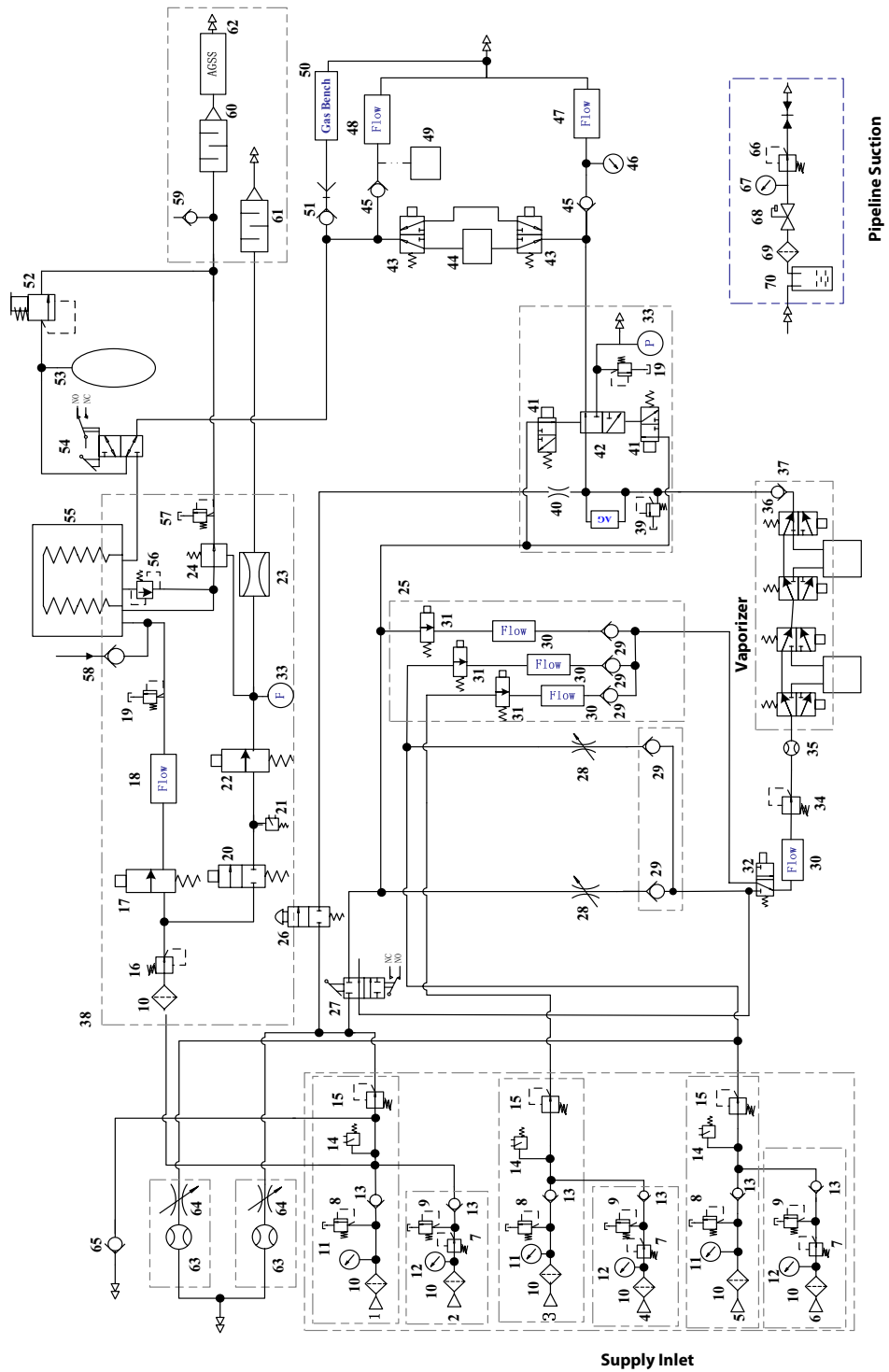


FIGURE D-1 Pneumatic Diagram of the A7 System

NO.	DESCRIPTION	NO.	DESCRIPTION
1.	O <sub>2</sub> Gas Pipeline Connection	36.	Check Valve 3
2.	O <sub>2</sub> Gas Cylinder Connection	37.	Dual Vaporizer Block
3.	N <sub>2</sub> O Gas Pipeline Connection	38.	Ventilator
4.	N <sub>2</sub> O Gas Cylinder Connection	39.	Pressure Relief Valve (37.9 kPa)
5.	Air Gas Pipeline Connection	40.	Flow Restrictor
6.	Air Gas Cylinder Connection	41.	Latching Valve
7.	Gas Cylinder Pressure Regulator (360 kPa)	42.	Electronic ACGO Valve
8.	Pressure Relief Valve (758 kPa)	43.	Bypass
9.	Pressure Relief Valve (Regulator)	44.	CO <sub>2</sub> Absorber Canister
10.	Drive Gas Inlet Filter	45.	Check Valve
11.	Gas Pipeline Pressure Gauge	46.	Airway Pressure Gauge
12.	Gas Cylinder Pressure Gauge	47.	Inspiratory Flow Sensor
13.	Check Valve 1	48.	Expiratory Flow Sensor
14.	Pressure Switch (220 kPa)	49.	Watertrap
15.	Pressure Regulating Valve (200 kPa)	50.	Gas Bench
16.	Pressure Regulator (200 kPa)	51.	Check Valve
17.	Inspiratory Flow Control Valve	52.	APL Valve
18.	Inspiratory Flow Sensor	53.	Breathing Bag
19.	Safety Valve (110 cmH <sub>2</sub> O)	54.	Auto/Manual Bag Switch
20.	PEEP Safety Valve	55.	Bellows
21.	Drive Gas Pressure Switch (140 kPa)	56.	Pop-off Valve
22.	PEEP Proportional Valve	57.	Pressure Relief Valve (1 kPa, 10 cmH <sub>2</sub> O)
23.	Flow Restrictor	58.	Negative Pressure Check Valve
24.	Exhaust Valve	59.	Negative Pressure Check Valve (1 cmH <sub>2</sub> O)
25.	Electronic Flow Control System	60.	Gas Container 1
26.	O <sub>2</sub> Flush Valve	61.	Gas Container 2
27.	System Switch	62.	AGSS
28.	Needle Valve	63.	Auxiliary Air Flowmeter
29.	Check Valve 2	64.	Auxiliary Flow Needle Valve
30.	Flow Sensor	65.	Auxiliary O <sub>2</sub> Gas Power Outlet
31.	Proportional Valve	66.	Suction Regulator
32.	3-way Valve	67.	Vacuum Gauge
33.	Pressure Sensor	68.	Overflow Safety Trap
34.	Back Pressure Valve	69.	Filter
35.	Total Flowmeter	70.	Collection Container

**This page intentionally left blank.**

---

E.0

# ***Abbreviations, Symbols, and Units of Measure***

---

Abbreviations .....	E-2
Symbols .....	E-4
Units of Measure .....	E-5
Attention Symbols .....	E-6

## E.1 Abbreviations

ABBREVIATION	DESCRIPTION
AA	anesthetic agent
ACGO	auxiliary common gas outlet
AG	anesthetic gas
AGSS	anesthetic gas scavenging system
APL	airway pressure limit
Apnea Ti	inspiratory time for apnea backup breaths
BFCS	backup flow control system
BTPS	body temperature and pressure, saturated
C	compliance ( $C_{dyn}$ )
CO <sub>2</sub>	carbon dioxide
Des	desflurane
EFCS	electronic flow control system
ENF	enflurane
Et	end-tidal
EtAA	end-tidal anesthetic agent
EtCO <sub>2</sub>	end-tidal carbon dioxide concentration at expiration
EtDES	end-tidal desflurane concentration at expiration
EtENF	end-tidal enflurane concentration at expiration
EtHAL	end-tidal halothane concentration at expiration
EtISO	end-tidal isoflurane concentration at expiration
EtN <sub>2</sub> O	end-tidal nitrous oxide concentration at expiration
EtO <sub>2</sub>	end-tidal oxygen concentration at expiration
EtSEV	end-tidal sevoflurane concentration at expiration
EUI	extended unique identifier
Fi	fractional concentration
FIAA	fractional concentration of anesthetic agent in inspired gas
FiCO <sub>2</sub>	fractional concentration of carbon dioxide in inspired gas
FIDES	fractional concentration of desflurane in inspired gas
FIENF	fractional concentration of enflurane in inspired gas
FiHAL	fractional concentration of halothane in inspired gas
FiISO	fractional concentration of isoflurane in inspired gas
FiN <sub>2</sub> O	fractional concentration of nitrous oxide in inspired gas
FiO <sub>2</sub>	fractional concentration of oxygen in inspired gas
FISEV	fractional concentration of sevoflurane in inspired gas
Flow	flow
HAL	halothane
I:E	ratio of inspiration time to expiration time
ISO	isoflurane
MAC	mean alveolar concentration
MEAN	mean pressure



<b>ABBREVIATION</b>	<b>DESCRIPTION</b>
Min Rate	minimum breath rate
MV	minute volume
N <sub>2</sub> O	nitrous oxide
O <sub>2</sub>	oxygen
P <sub>insp</sub>	pressure control level of inspiration
P <sub>limit</sub>	pressure limit level
P <sub>lim</sub> VG	pressure limit level of volume guarantee
PAW	airway pressure
PCV	pressure control ventilation
PEAK	peak pressure
PEEP	positive end-expiratory pressure
PLAT	plateau pressure
PS	pressure support
ΔP	pressure support level added to PEEP
R	resistance
Rate	breath rate
SEV	sevoflurane
SIMV-PC	synchronized intermittent mandatory ventilation - pressure control
SIMV-VC	synchronized intermittent mandatory ventilation - volume control
SP	Spontaneous breathing
T <sub>insp</sub>	time of inspiration
T <sub>pause</sub>	percentage of inspiratory plateau time in inspiratory time
T <sub>slope</sub>	time for the pressure to rise to target pressure
Trigger	trigger sensitivity
V <sub>t</sub>	tidal volume
V <sub>t</sub> G	tidal volume guarantee
VCV	volume control ventilation
VG	volume guarantee control

## E.2 Symbols

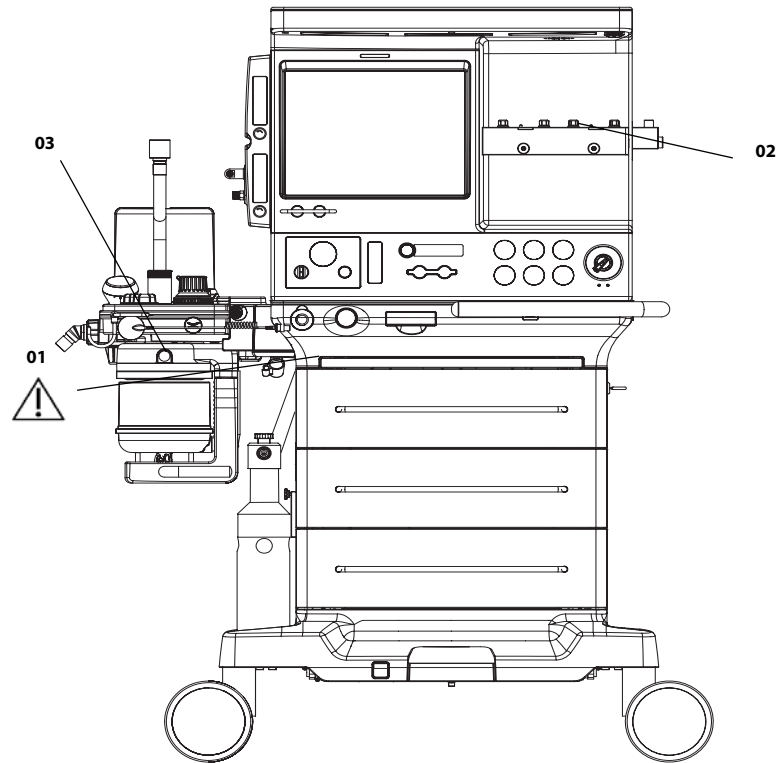
<b>SYMBOL</b>	<b>DESCRIPTION</b>	<b>SYMBOL</b>	<b>DESCRIPTION</b>
-	minus	>	greater than
%	percent	≤	less than or equal to
/	per, divide, or	≥	greater than or equal to
≈	approximately	±	plus or minus
^	power	×	multiply
+	plus	©	copyright
=	equal to	™	trademark
<	less than	®	registered trademark

## E.3 Units of Measure

UNIT OF MEASURE	DESCRIPTION	UNIT OF MEASURE	DESCRIPTION
A	Ampere, Amp	m	meter
Ah	Amp hour	mAh	microAmp hour
bpm	breath per minute	mbar	mbar
°C	degree Celsius	mg	milligram
cc	cubic centimeter	min	minute
cm	centimeter	ml, mL	milliliter
cmH <sub>2</sub> O	centimeter of water	mm	millimeter
dB	decibel	mmHg	millimeter of mercury
°F	Fahrenheit	ms	millisecond
g	gram	mV	milliVolt
hr	hour	mW	milliWatt
Hz	Hertz	ppm	part per million
hPa	hectoPascal	s, sec	second
inch	inch	V	Volt
k	kilo	VA	Volt Amp
kg	kilogram	VAC	Volts alternating current
kPa	kiloPascal	Ω	Ohm
psi	pound-force per square inch	μA	microAmp
L, l	liter	μV	microVolt
lb	pound	W	Watt
nm	nanometer		

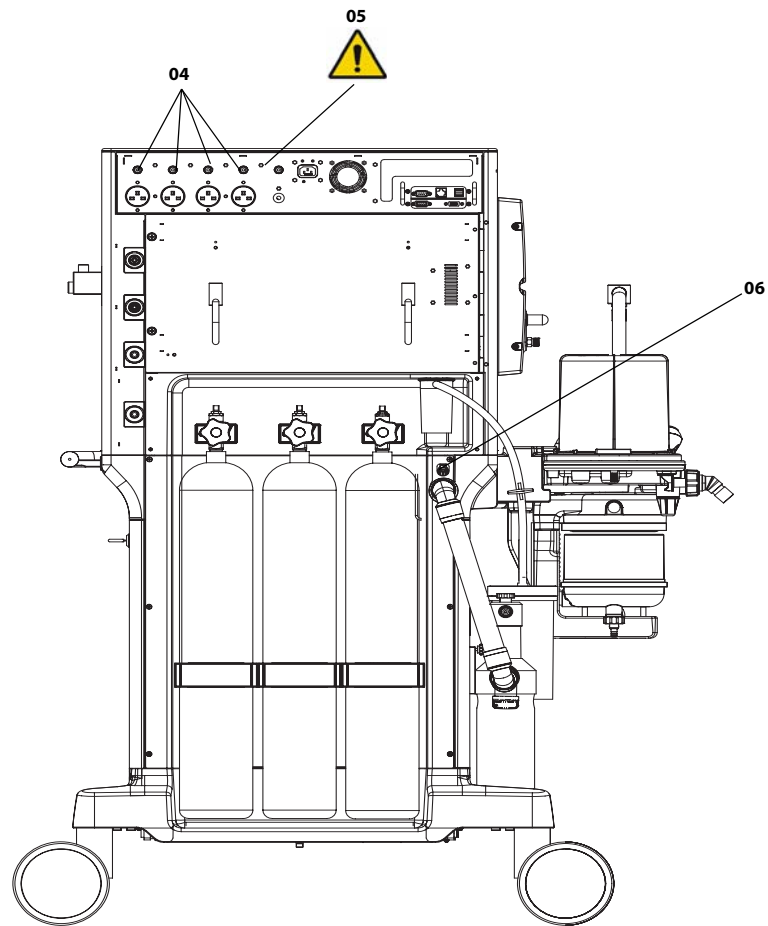
## E.4 Attention Symbols

The following figures provide descriptions of symbols of Attention that are used on the device and/or within this manual.



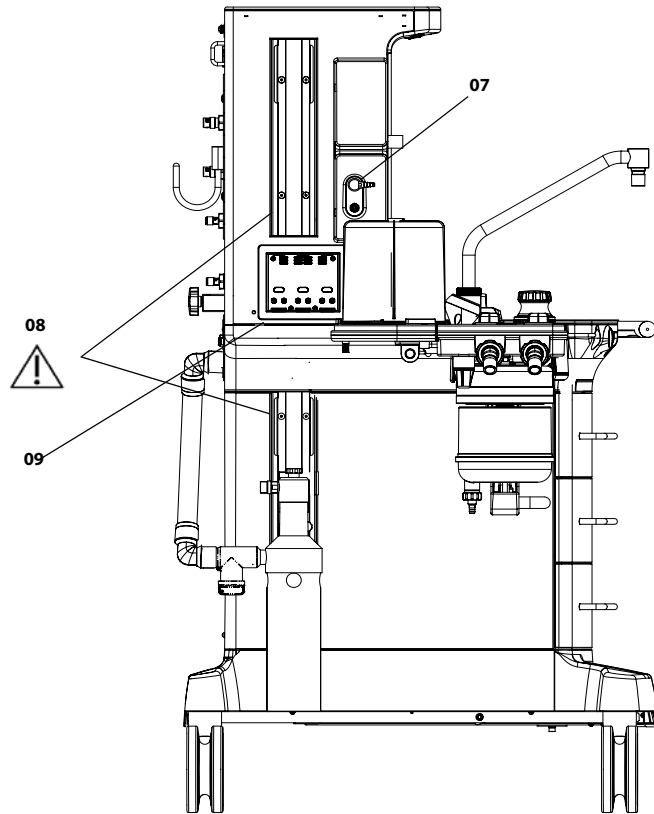
**FIGURE E-1** Main Unit (Front View)

ATTENTION! NUMBER	DESCRIPTION
01	<p>Auxiliary work surface. When the drawer is closed, depress the auxiliary work surface inward to pull it out. Maximum supporting weight: 10 kg (22 lbs)</p> <p><b>NOTE:</b> This equipment is configured with auxiliary work surface only when electronically controlled ACGO is configured.</p>
02	<p>Only vaporizers with Selectatec Interlock-Systems may be used with the A7 unit.</p> <p>Use vaporizers compliant to ISO 80601-2-13. See chapter "Accessories". Refer to the vaporizer manufacturer's Instructions For Use for filling or draining the vaporizer and other information.</p> <p>Use care in lifting and manipulating vaporizers during the mounting process as their weight may be greater than expected, based on their size and shape.</p>
03	<p>Remove the absorber canister first. Then press inward the fasteners on both sides and the CO<sub>2</sub> bypass assembly will drop down indicating that the breathing system block is unlocked. In this case, you can firmly separate and slide it away from its mounting arm while holding the sides of the breathing system block.</p>



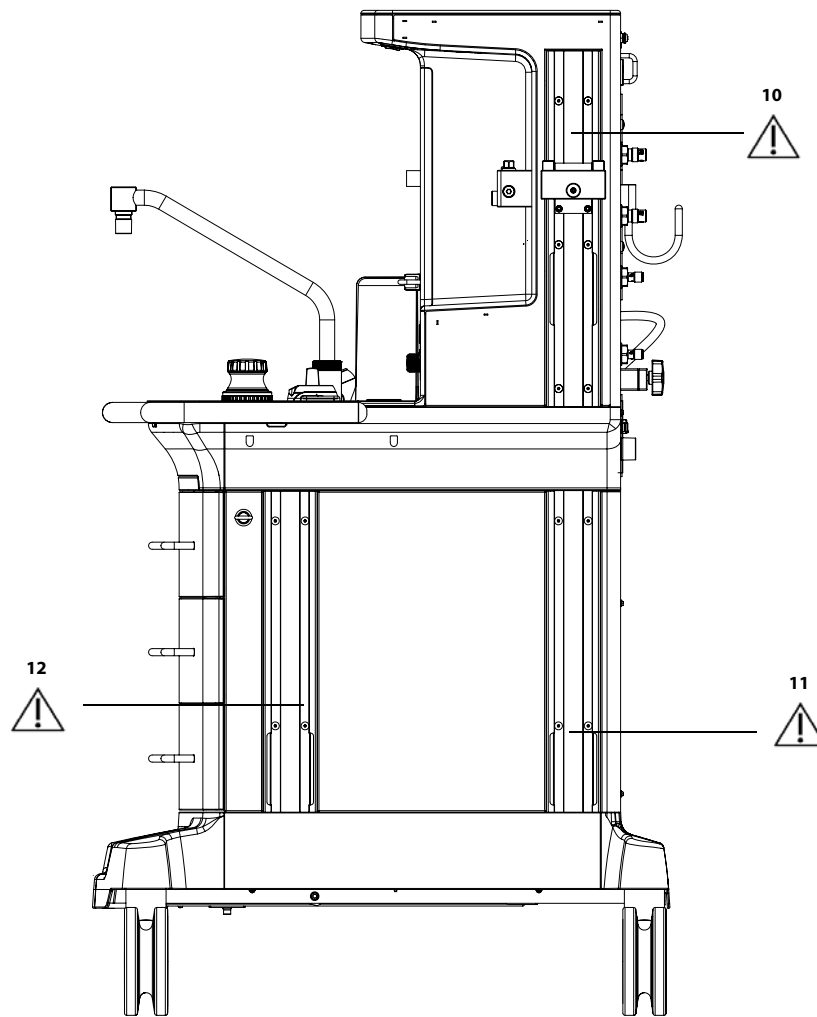
**FIGURE E-2** Main Unit (Rear View)

ATTENTION! NUMBER	DESCRIPTION
04	Each auxiliary outlet is rated at 100 to 120 VAC @ 50/60 Hz.
05	Individual outlet current is limited to 3 A. Total mains output current is limited to 10 A.
06	Sample Line Exhaust Gas Inlet: Inlet for waste gas from an optionally attached gas module. Merges with the AGSS connector that connects to the AGSS.



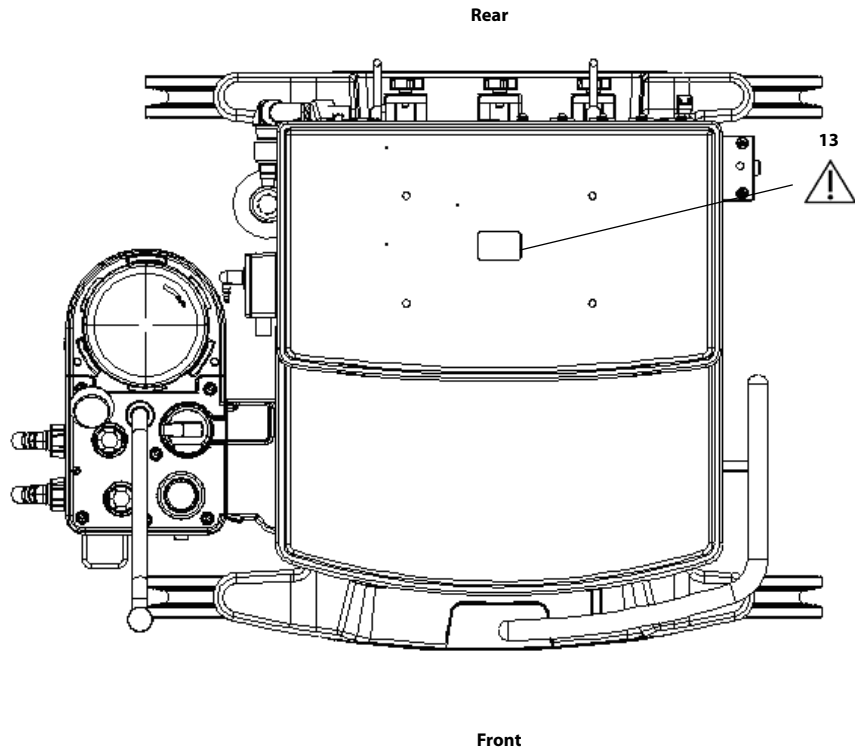
**FIGURE E-3** Main Unit (Left View)

ATTENTION! NUMBER	DESCRIPTION
07	Auxiliary O <sub>2</sub> /Air Gas Outlet: Nozzle (barbed connector) for auxiliary O <sub>2</sub> /Air output. Combines the auxiliary O <sub>2</sub> /Air flowmeters into a single output.
08	Maximum supporting weight: 25 kg at a maximum distance of 0.31 m.
09	Only AG module provided by Mindray can be used.



**FIGURE E-4** Main Unit (Right View)

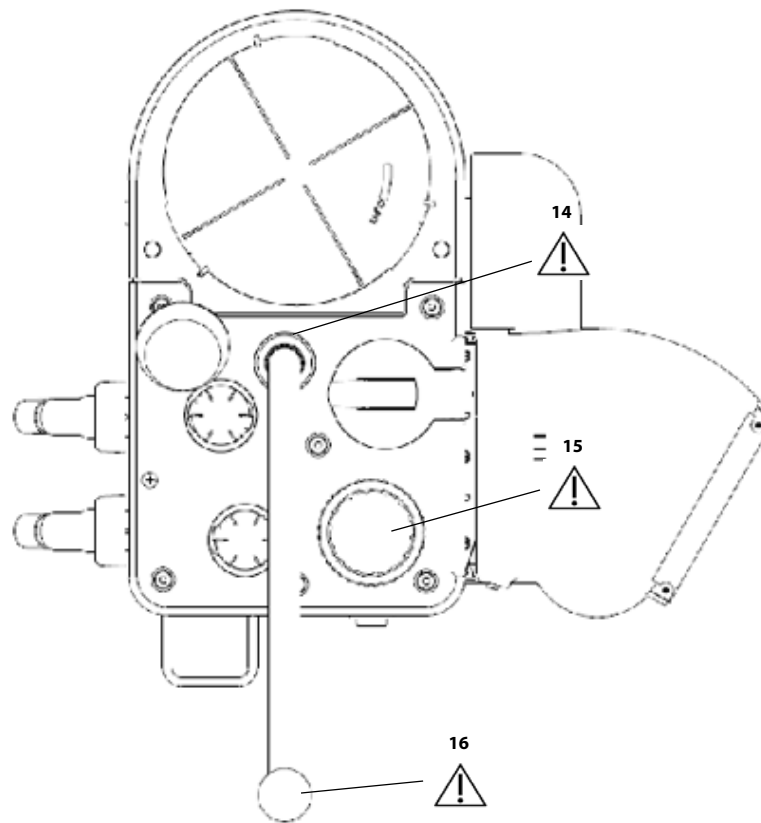
<b>ATTENTION! NUMBER</b>	<b>DESCRIPTION</b>
10	Maximum supporting weight: 25 kg at a maximum distance of 0.31 m.
11	Maximum supporting weight: 25 kg at a maximum distance of 0.31 m.
12	Maximum supporting weight: 25 kg at a maximum distance of 0.31 m.



**FIGURE E-5** Main Unit (Top View)

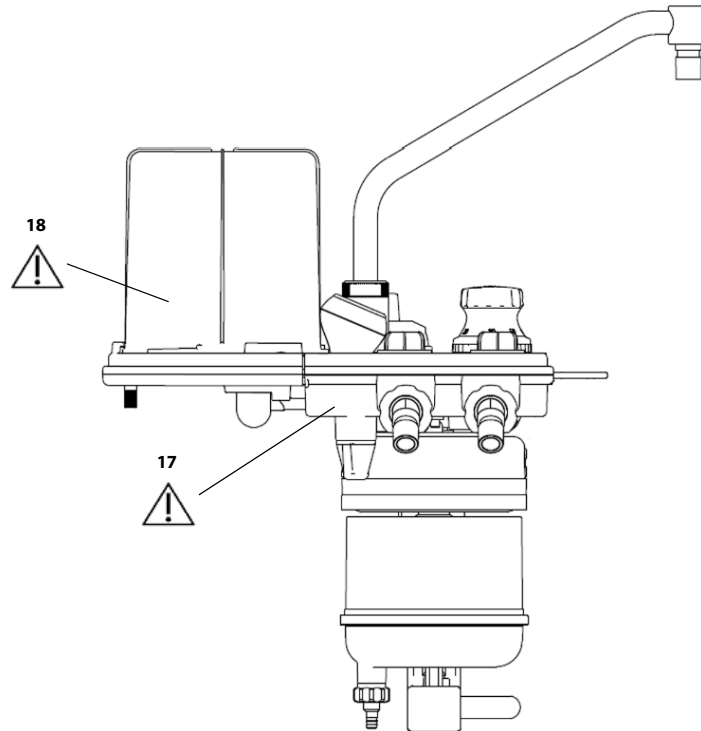
ATTENTION! NUMBER	DESCRIPTION
13	Top Shelf: 40 kg MAX. 88 lbs MAX.





**FIGURE E-6** Breathing System (Top View)

ATTENTION! NUMBER	DESCRIPTION
14	Autoclavable up to 134°C. Polyphenylsulfone (PPSU).
15	APL Valve: The APL valve and PAW gauge numerics are for reference only. Calibrated patient airway pressure is displayed on the user interface.
16	Do not push down on the bag arm forcefully or hang heavy objects onto it. Excessive weight may bend and damage the bag arm.



**FIGURE E-7** Breathing System (Left View)

ATTENTION! NUMBER	DESCRIPTION
17	134°C >PPSU<. Autoclavable up to 134°C.
	Operating the A7 with a full water trap in the breathing system block does not allow the water to condense appropriately. The trap should be removed and emptied when filled with water.
	Operating without a water trap will cause the leak test to fail.
18	Bellows Dome: The bellows dome is a transparent cover with graduation marks from 300 to 1500. These marks are for qualitative purposes only. Tidal volume (VT) should be read exclusively from the display of the user interface. Delivered tidal volume (VT) is a combination of bellows displacement and fresh gas flow.

---

F.0

# ***Preparation for Malignant Hyperthermia Susceptible Patients***

---

Malignant Hyperthermia Causes, Effects and Treatment .....	F-2
Malignant Hyperthermia Washout .....	F-2
Washout Procedure for Malignant Hyperthermia Susceptible Patients with A7 Anesthesia Delivery Systems .....	F-2
References .....	F-4

## F.1 Malignant Hyperthermia Causes, Effects and Treatment

Malignant Hyperthermia (MH) is an uncommon inherited, life-threatening pharmacokinetic skeletal muscle disorder involving the dysregulated myoplasmic  $\text{Ca}^{2+}$ , hypercontracture, and hypermetabolism. Triggering factors include exposure to potent volatile anesthetic gases and depolarizing muscle relaxants.<sup>1-4</sup>

The disorder is characterized by skeletal muscle hypermetabolism, which is related to an uncontrolled release of calcium from skeletal muscle sarcoplasmic reticulum. These results in increased carbon dioxide production, increased core temperature, and generalized muscle rigidity with resultant rhabdomyolysis, acidosis, and hyperkalemia. If untreated, MH may lead to cardiac arrhythmia, multiorgan system failure, and death.<sup>2,3</sup>

MH has had a reported mortality rate decrease from 70%-80% to less than 5% if preventive measures and effective management are adopted.<sup>2</sup> The early therapy requires immediate discontinuation of all the triggering agents, adequate oxygenation and ventilation, institution of aggressive cooling measures, administration of dantrolene sodium, and appropriate treatment for hyperkalemia. Ultimately, the only effective treatment for an MH crisis is the intravenous administration of dantrolene sodium and supportive therapy to combat the symptoms.<sup>1,2</sup>

## F.2 Malignant Hyperthermia Washout

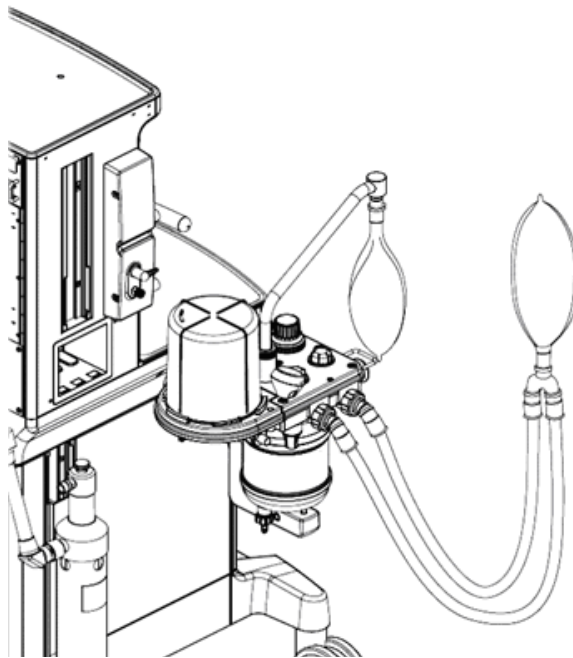
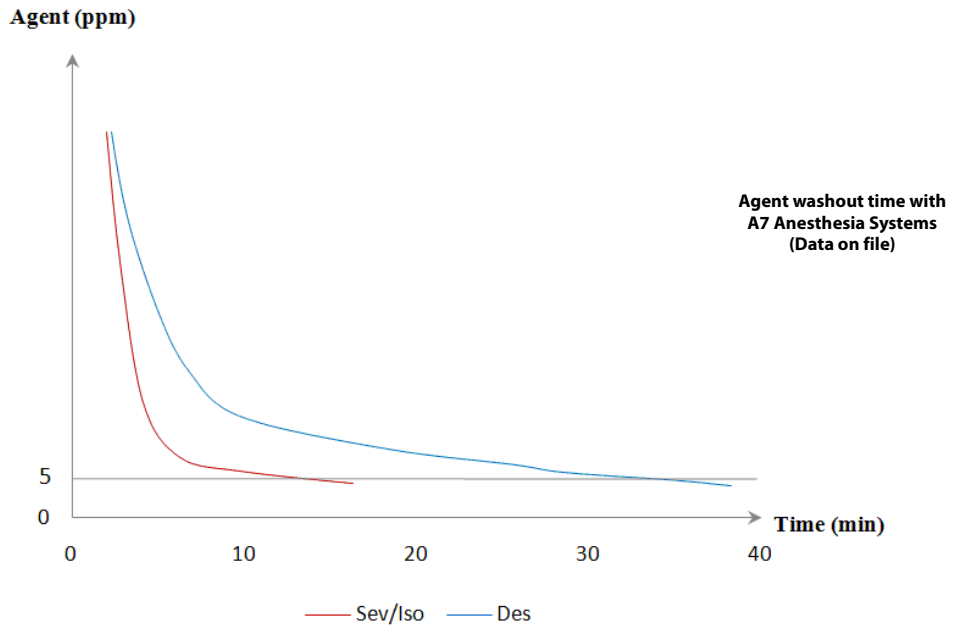
To prevent MH in susceptible patients or to treat MH occurring during inhalational anesthesia, all inhalational anesthetics should be removed from the anesthesia machine. Avoidance of potent vapor anesthetics, such as Sevoflurane, Isoflurane or Desflurane,<sup>4</sup> in patient cases is more challenging, based on the complex newer generation anesthesia machines and breathing circuits which retain anesthetic vapors long after discontinuation. The ultimate goal is to eliminate the residual anesthetic vapor concentration within the breathing system. The recommended instructions for clearing residual anesthetic gases include removal or disabling of vaporizers, flushing the machine using the ventilator with a fresh gas flow rate more than 10 L/min, replacement of the carbon dioxide absorbent and anesthesia circuit.<sup>1,3</sup>

## F.3 Washout Procedure for Malignant Hyperthermia Susceptible Patients with A7 Anesthesia Delivery Systems

The minimum inhaled concentration for triggering an episode of MH is unknown. Studies assumed a trace concentration of inhalational anesthetics below 5 ppm to be safe.<sup>5-8</sup> the following steps are recommended to prepare a A7 anesthesia system for an MH-susceptible patient.

1. Turn off and remove all the vaporizers from the anesthesia system to prevent their inadvertent use.
2. Remove the carbon dioxide absorbent, breathing bag and the entire patient breathing circuit, filters, sampling line, water trap, and airway adapter and replace with new circuit and parts, connect a new breathing bag or test lung to the patient Y-piece.
3. Ventilate for a minimum of 40 minutes using mechanical ventilation with the following settings, 700 ml tidal volume, I:E ratio of 1:2, 12 breaths/minute, PEEP Off, and oxygen fresh gas flow rate of 15 L/min.

4. Upon completion of the 40 minute flush, remove the patient breathing circuit. Allow the bellows to deflate completely. Replace with a new patient breathing circuit, including bag and new carbon dioxide absorbent. Perform the pre-operative checkout.
5. Maintain the oxygen fresh gas flow rate of 15 L/min throughout the case to functionally create a non-rebreathing system and minimize rebound of volatile concentration at low fresh gas flow rates.



**FIGURE F-1** Washout Procedure for Malignant Hyperthermia Susceptible Patients

**The following guidelines are recommended by the Malignant Hyperthermia Association of the United States (MHAUS)\***

**Preparation of Anesthesia Workstations to Anesthetize MH Susceptible Patients**

**Recommendations (4 alternatives):**

1. Flush and prepare workstation according to manufacturer's recommendations or published studies; this may take 10 to >90 minutes. Most studies also physically disconnect vaporizers from the workstation; use a new, disposable breathing circuit; and replace the carbon dioxide absorbent. During the case, fresh gas flow should be kept at 10 liters per minute to avoid "rebound phenomenon" (increased release of residual volatile anesthetic agent when fresh gas flow is reduced after a set period of flushing). or
2. Use commercially available charcoal filters that have been shown to remove trace levels of volatile anesthetic agents within 10 minutes of application, without additional preparation. These filters may have to be regularly replaced during the anesthetic.<sup>++</sup> or
3. If available, use a dedicated "vapor free" machine for MH-susceptible patients. The machine must be regularly maintained and safety-checked. or
4. If appropriate to the institution, use an ICU ventilator that has never been exposed to volatile anesthetic agents.

For further information contact the Malignant Hyperthermia Association of the United States at <http://www.mhaus.org/>

\*: Guidelines are excerpted from the MHAUS website and do not replace the indicated instructions for preparation of the A7.

<sup>++</sup>: This method has not been tested with A7.

## F.4 References

1. Hopkins PM. Malignant hyperthermia: pharmacology of triggering. *Br J Anaesth.* 2011 Jul; 107 (1): 48-56.
2. Kim DC. Malignant hyperthermia. *Korean J Anesthesiol.* 2012 Nov; 63 (5): 391-401.
3. Kim TW, Nemergut ME. Preparation of modern anesthesia workstations for malignant hyperthermia-susceptible patients: a review of past and present practice. *Anesthesiology.* 2011 Jan;114 (1):205-212.
4. Schuster F, Johannsen S, Schneiderbanger D, Roewer N. Evaluation of suspected malignant hyperthermia events during anesthesia. *BMC Anesthesiology* 2013, 13: 24.
5. Gunter JB, Ball S, Tan-Win S. Preparation of the Dräger Fabjus anesthesia machine for the malignant -hyperthermia susceptible patient. *Anesth Analg* 2008; 107: 1936-45.
6. Reber A, Schumacher P, Urwyler A. Effects of three different types of management on the elimination kinetics of volatile anaesthetics. Implications for malignant hyperthermia treatment. *Anaesthesia* 1993; 48: 862-5.
7. Crawford MW, Prinzhausen H, Petroz GC. Accelerating the washout of inhalational anesthetics from the Dräger Primus anesthetic workstation. *Anesthesiology* 2007; 106:289-94.
8. Prinzhausen H, Crawford MW, O'Rourke J, Petroz GC. Preparation of the Dräger Primus anesthetic machine for malignant hyperthermia-susceptible patients. *Can J Anesth* 2006; 53: 885-90.

---

*Mindray DS USA, Inc. • 800 MacArthur Boulevard • Mahwah, NJ 07430 • USA •  
Dom. Customer Service: 1.800.288.2121 • Intl. Customer Service: +1.201.995.8000 •  
Dom. Fax: 1.800.926.4275 • Intl. Fax: +1.201.995.8680 • www.mindray.com*

*Mindray Medical Netherlands B.V. • Drs. W. van Royenstraat 8 • P.O. Box 26 • 3870 CA  
Hoevelaken • The Netherlands • Tel: +31 33 25 44 911 • Fax: +31 33 25 37 621*

*Mindray (UK) Limited • 3 Percy Road • St. John's Park • Huntingdon • Cambridgeshire PE29 6SZ •  
United Kingdom • Tel: 01480 416840 • Fax: 01480 436588*

*Mindray Medical France SARL • Europarc Créteil • 123, Chemin des Bassins •  
94035 Créteil Cedex • France • Tel: (0)1.45.13.91.50 • Fax: (0)1.45.13.91.51*

*Mindray Medical Germany GmbH • Zwischen den Bächen 4 • 64625 Bensheim • Deutschland •  
Tel: +49.6251.17524-0 • Fax: +49.6251.17524-20*

*Mindray Medical International Ltd. • 2813 Office Tower, Convention Plaza • No 1 Harbour Road •  
Wanchai • Hong Kong • Tel: +852 2793 5596 • Fax: +852 2344 8824*

*Medstar Importação e Exportação Ltda • Av. Vereador José Diniz, 3300 • São Paulo, SP • CEP  
04804-000 • Brazil • Tel: 55 11 2872-3385 • Fax: 55 11 2872-3385*

