

Operating Instructions

A5™ | A3™

Anesthesia System

mindray

Operating Instructions

A5™ | A3™
Anesthesia System

mindray

A5™ and A3™ are U.S. trademarks of Mindray DS USA, Inc.

Selectatec® is a registered trademark of Ohmeda.

Table of Contents

Foreword	vii
Indications For Use	vii
Responsibilities of Operators	vii
Warnings, Cautions, and Notes	vii
Warnings.....	viii
Cautions.....	xii
Notes.....	xv
Warranty Statements	xvii
Disclaimers.....	xvii
Phone Numbers and How To Get Assistance.....	xviii
Manufacturer's Responsibility	xviii
Manufacturer and Address	xviii
Symbols.....	xviii
Product Description.....	1 - 1
General System Overview	1 - 2
General Description.....	1 - 2
Key Features	1 - 3
Fresh Gas Dosing	1 - 3
Flow Control.....	1 - 4
Vaporizer Mounting.....	1 - 4
Anesthesia Ventilator	1 - 5
Breathing System	1 - 5
Active Anesthetic Gas Scavenging System (AGSS)	1 - 6
Passive Anesthetic Gas Scavenging System (AGSS)	1 - 6
Power Management / Battery Supply.....	1 - 6
Workplace Ergonomics.....	1 - 8
Hook	1 - 8
Physical Views.....	1 - 9
Main Unit (Front View).....	1 - 9
Main Unit (Rear View).....	1 - 11
Main Unit (Left View).....	1 - 13
Main Unit (Right View).....	1 - 14
Main Unit (Top View).....	1 - 15
Breathing System (Top View)	1 - 16
Breathing System (Left View)	1 - 17
Active Anesthetic Gas Scavenging System (AGSS) (Top, Right, and Rear Views).....	1 - 19
Passive Anesthetic Gas Scavenging System (AGSS) (Right View)	1 - 21
Installation	2 - 1
Unpacking.....	2 - 3
Initial Setup.....	2 - 4
Install the Vaporizer.....	2 - 5
Filling and Draining the Vaporizer	2 - 7
System Interface	3 - 1
Main Screen Components.....	3 - 2
System Information Header	3 - 6
Elapsed / Countdown Timer.....	3 - 6
Patient Size	3 - 7
Alarm and Prompt Messages	3 - 7
Alarm Silence Icon.....	3 - 8
Date and Time	3 - 9

Battery Status	3 - 10
Fresh Gas Flow Display	3 - 11
Waveforms Tab	3 - 12
Waveforms Autoscaling	3 - 12
Waveforms Manual Scaling	3 - 13
Spirometry Tab (A5 Only)	3 - 14
Loop Type	3 - 16
Show Reference	3 - 17
Save Loop	3 - 17
Review Loops Button	3 - 17
Demographics Tab	3 - 20
Ventilation Mode Tabs	3 - 21
Measured Values Area	3 - 24
System Softkeys	3 - 25
Setup Softkey	3 - 25
Alarms Softkey	3 - 25
Silence Softkey	3 - 25
Capture Event (software bundle version 02.02.00 and later)	3 - 25
History (software bundle version 02.02.00 and later)	3 - 25
Setup	3 - 32
General Tab	3 - 32
Display Tab	3 - 34
System Tab	3 - 38
Network Configuration	3 - 41
Service Tab	3 - 44
Preoperative Tests	4 - 1
Preoperative Test Schedules	4 - 2
Test Intervals	4 - 2
Inspect the System	4 - 3
Pre-Operative Checkout List	4 - 4
Introduction	4 - 4
Suggested Pre-Operative Checkout List	4 - 4
System Self-Test	4 - 6
Leak and Compliance Tests	4 - 9
Automatic Circuit Leak and Compliance Test	4 - 9
Manual Circuit Leak Test	4 - 14
Preoperative Check List (software bundle version 02.09.00 and later)	4 - 17
Power Failure Alarm Test	4 - 18
Pipeline Tests	4 - 18
O ₂ Pipeline Test	4 - 18
N ₂ O Pipeline Test	4 - 18
Air Pipeline Test	4 - 19
Basic Ventilation Testing	4 - 19
Cylinder Tests	4 - 20
Check the Cylinder Pressure	4 - 20
O ₂ Cylinder High Pressure Leak Test	4 - 20
N ₂ O Cylinder High Pressure Leak Test	4 - 20
Air Cylinder High Pressure Leak Test	4 - 20
Flow Control System Test	4 - 21
Vaporizer Tests	4 - 22
Vaporizer Back Pressure Test	4 - 22
Manual Leak Test	4 - 22

Vaporizer Leak Test	4 - 22
Breathing System Tests	4 - 24
Bellows Test	4 - 24
Breathing System Leak Test in Manual Ventilation Status	4 - 24
APL Valve Test.....	4 - 25
Alarm Tests	4 - 26
Prepare for Alarm Tests	4 - 26
Test the O ₂ Concentration Monitoring and Alarms	4 - 26
Test the Low Minute Volume (MV) Alarm.....	4 - 27
Test the Apnea Alarm.....	4 - 27
Test the Continuous Airway Pressure Alarm	4 - 27
Test the High Paw Alarm.....	4 - 28
Test the Low Paw Alarm.....	4 - 28
Preoperative Preparations	4 - 28
Inspect the Active AGSS.....	4 - 29
Operations.....	5 - 1
Powering On the A5/A3 Anesthesia System	5 - 2
Powering Off the A5/A3 Anesthesia System	5 - 2
Patient Setup.....	5 - 3
End Case / Standby Mode	5 - 3
Select the Patient Size (Adult, Pediatric, Infant)	5 - 5
Oxygen Sensor Calibration	5 - 5
Input Fresh Gas	5 - 6
Set N ₂ O, Air, and O ₂ Inputs	5 - 6
Set Anesthetic Agent	5 - 7
Ventilation Modes.....	5 - 8
Monitored Parameters.....	5 - 8
Ventilation Modes	5 - 8
Change Ventilation Mode	5 - 8
Set Manual Ventilation Mode.....	5 - 9
Setting Monitor Mode (A5 with AG Module connected)	5 - 11
Make Settings before Starting Mechanical Ventilation Mode	5 - 14
Volume Control Ventilation (VCV)	5 - 14
Pressure Control Ventilation (PCV).....	5 - 15
Synchronized Intermittent Mandatory Ventilation (SIMV).....	5 - 16
Pressure Support Ventilation (PS).....	5 - 18
Start Mechanical Ventilation	5 - 19
Stop Mechanical Ventilation	5 - 19
Relationships of Ventilation Parameters.....	5 - 19
Parameter Monitoring (Numerics)	5 - 20
Pressure.....	5 - 20
Volume	5 - 20
Gas (available with the AG module)	5 - 21
Inspired O ₂ (available without the AG module)	5 - 21
Parameter Monitoring (Waveforms).....	5 - 22
Pressure Waveform	5 - 22
Flow Waveform	5 - 22
Volume Waveform	5 - 23
Gas Waveform (available with the AG module)	5 - 23
Waveform Autoscaling.....	5 - 25
Parameter Monitoring (Spirometry, A5 Only).....	5 - 26

Alarms and Messages	6 - 1
Introduction	6 - 2
Alarm System Self-Test.....	6 - 2
Types of Alarms and Messages.....	6 - 3
Alarm Indicators.....	6 - 4
Displaying Alarms	6 - 5
Displayed Order of Alarm Messages.....	6 - 6
Setting Alarm Volume	6 - 7
Silencing Alarms	6 - 8
Alarm Limits.....	6 - 9
Setting Alarm Limits	6 - 9
Loading Alarm Defaults.....	6 - 12
Auto Alarm Limits.....	6 - 14
Setting CO2 Apnea Delay Time (software bundle version 02.09.00 and later)	6 - 14
Alarm and Prompt Messages	6 - 15
Technical Alarm Messages	6 - 18
Prompt Messages	6 - 26
Maintenance	7 - 1
Theory of Operation	7 - 3
Block Diagram.....	7 - 3
Maintenance Schedule.....	7 - 4
Breathing System Maintenance.....	7 - 4
Flow Sensor Calibration	7 - 5
O ₂ Sensor Calibration.....	7 - 6
Calibrate the O ₂ Sensor.....	7 - 7
Water Build-up in the Flow Sensor.....	7 - 9
Prevent Water Build-up	7 - 9
Clear Water Build-up	7 - 9
AGSS Transfer Tube Maintenance	7 - 9
Electrical Safety Inspection	7 - 9
Auxiliary Electrical Outlet Test	7 - 9
Electrical Safety Inspection Test.....	7 - 10
Cleaning and Disinfection.....	7 - 11
General Guidelines.....	7 - 11
Cleaning and Disinfecting Agents / Autoclaving.....	7 - 11
External Surfaces.....	7 - 12
Bellows Assembly	7 - 12
Inspiration and Expiration Valves	7 - 15
Oxygen Sensor.....	7 - 18
APL Valve	7 - 19
PAW Gauge.....	7 - 20
Bag Arm.....	7 - 21
Absorber Canister.....	7 - 22
Breathing System Block.....	7 - 25
Active AGSS (Anesthetic Gas Scavenging System) and AGSS Transfer Hose	7 - 28
Regular Maintenance	7 - 30
AG and O₂ Concentration Monitoring (Optional)	8 - 1
Introduction	8 - 2
Understand MAC Values	8 - 3
Identify External AG Modules	8 - 4
Prepare to Measure AG	8 - 5
Make AG Settings	8 - 6

Set CO2 Unit	8 - 6
Set CO2 Placement	8 - 6
Set CO2 Scale	8 - 6
Gas Bench Flow Rate	8 - 6
Set Alarm Limits	8 - 7
Measurement Limitations	8 - 8
Troubleshooting	8 - 8
Scavenge the Sample Gas	8 - 9
Calibrate the AG Module	8 - 10
Product Specifications.....	9 - 1
Standards Compliance	9 - 2
Safety Designations	9 - 4
Oxygen Enriched Environments	9 - 4
Wiring and PC Board Materials	9 - 4
Physical Specifications.....	9 - 5
Stability Configurations and Conditions.....	9 - 5
Environmental Specifications	9 - 6
Electrical Specifications.....	9 - 7
Main Electrical Power Specifications	9 - 7
Battery Power Specifications.....	9 - 7
Auxiliary Electrical Outlets.....	9 - 7
Communication Ports.....	9 - 8
Pneumatic Specifications	9 - 9
Pipeline Supply (N ₂ O, Air, O ₂)	9 - 9
Cylinder Supply (N ₂ O, Air, O ₂).....	9 - 9
Vaporizer Connections	9 - 9
Drive Gas.....	9 - 9
N ₂ O Automatic Cutoff.....	9 - 9
O ₂ Controls	9 - 10
Oxygen Ratio Controller.....	9 - 10
Breathing System Specifications	9 - 11
Breathing System Volume.....	9 - 11
CO ₂ Absorber Assembly.....	9 - 11
Water Trap.....	9 - 11
Breathing System Connections	9 - 11
APL Valve	9 - 11
Resistance.....	9 - 12
Breathing System Temperature Controller	9 - 13
Breathing Circuit Parameters	9 - 13
Materials	9 - 13
Anesthetic Gas Scavenging System (AGSS).....	9 - 14
Monitor Module	9 - 14
AG Module	9 - 14
Alarms.....	9 - 16
Effect of Interfering Gas on AG Measured Value	9 - 17
Ventilator Specifications	9 - 18
Displays and Controls Specifications	9 - 20
Electronic Controls.....	9 - 20
Pneumatic Controls	9 - 21
Alarms.....	9 - 22
Safety Specifications	9 - 23
ASTM F 1208 – 89 (2005) Disclosures	9 - 24

Leakage of Breathing System.....	9 - 24
Resistance of Breathing Systems	9 - 24
CO ₂ Absorber Resistance	9 - 24
CO ₂ Absorber Capacity.....	9 - 24
Unidirectional Valve Opening Pressure.....	9 - 25
Data Storage (Non-Volatile) and Recording	9 - 25
Electromagnetic Compatibility	9 - 26
Accessories	A - 1
Accessory Kits	A - 2
AG Accessories	A - 2
CO ₂ Absorbent Canister.....	A - 2
Gas Cylinder Accessories	A - 2
Gas Supply Hoses	A - 3
Manuals and Reference Cards	A - 3
Mounting Accessories	A - 3
Networking and USB Storage	A - 4
Vaporizers.....	A - 5
Scavenging Accessories.....	A - 5
User Accessible Spare Parts	B - 1
Active AGSS	B - 2
Breathing System	B - 2
CO ₂ Absorbent Canister.....	B - 2
Flow Sensor	B - 2
Gas Cylinder Accessories	B - 3
O ₂ Sensor.....	B - 3
Battery	B - 3
Parameters and Factory Defaults	C - 1
Waveform/Spirometry Tabs (A5 Only).....	C - 2
Alarm Limits.....	C - 3
Setup Menu	C - 5
Alarm Volume and History	C - 8
Date and Time	C - 8
Demographics	C - 9
Ventilation Modes	C - 9
Linked Ventilation Parameter	C - 13
Ventilation Parameter Relationships.....	C - 15
Pneumatic Diagram	D - 1
Pneumatic Diagram of the A5/A3 System.....	D - 2
Abbreviations, Symbols, and Units of Measure	E - 1
Abbreviations	E - 2
Symbols.....	E - 4
Units of Measure.....	E - 4
Attention Symbols	E - 5
Preparation for Malignant Hyperthermia Susceptible Patients	F - 1
Malignant Hyperthermia Causes, Effects and Treatment	F - 2
Malignant Hyperthermia Washout	F - 2
Washout Procedure for Malignant Hyperthermia Susceptible Patients with A5 Anesthesia Delivery Systems.....	F - 2
References.....	F - 4

Foreword

WARNING: Do not operate the A5/A3 Anesthesia System before reading these instructions.

The operating instructions for the A5/A3 Anesthesia Delivery System (hereinafter referred to as A5/A3 Anesthesia System, A5/A3 System, A5/A3, or individual A5 and A3) are intended to provide information for proper installation, operation, and general maintenance of the A5/A3 System to the user.

General knowledge and understanding of the features and functions of the A5/A3 System are prerequisites for its proper use.

For servicing information or assistance, please contact an authorized representative in your area.

Rx only: U.S. Federal Law restricts this device to sale by or on the order of a physician or other practitioner licensed by state law to use or order the use of this device.

NOTE: Figures in this manual are provided for reference purposes only. Screens may differ based on the system configuration and selected parameters.

Indications For Use

The A5/A3 Anesthesia System is a device used to administer to a patient, continuously or intermittently, a general inhalation anesthetic, and to maintain a patient's ventilation.

The A5/A3 is intended for use by licensed clinicians, for patients requiring anesthesia within a health care facility, and can be used for adult, pediatric, and infant populations.

WARNING: The A5/A3 is intended to be operated only by licensed clinicians and qualified anesthesia personnel who have received adequate training in its use. Anyone unauthorized or untrained must not perform any operation on the A5/A3.

WARNING: The A5/A3 is not suitable for use in an MRI environment.

Responsibilities of Operators

The proper function of the A5/A3 System can only be guaranteed if it is operated and serviced in accordance with the information provided in this manual and by an authorized Mindray service representative. Non-compliance with this information voids all guarantee claims.

The A5/A3 System must be operated by qualified and trained personnel only. All operators must fully observe these operating instructions and relevant additional documentation. They must also comply with the **WARNINGS**, **CAUTIONS**, and **NOTES** detailed in this manual.

Warnings, Cautions, and Notes

Please adhere to all warnings, cautions, and notes that are listed throughout this manual. They are summarized here for your reference.

WARNING — Indicates a potential hazard or unsafe practice that, if not avoided, could result in death or serious injury to the patient or user.

CAUTION — Indicates a potential hazard or unsafe practice that, if not avoided, could result in product/property damage or minor personal injury to the patient or user.

NOTE — Provides application tips or other useful information.

Warnings

- WARNING:** Do not operate the A5/A3 Anesthesia System before reading these instructions.
- WARNING:** All analog or digital products connected to this system must be certified passing the specified IEC standards (such as IEC 60950 for data processing equipment and IEC 60601-1 for medical electrical equipment). All configurations shall comply with the valid version of IEC 60601-1. The personnel who are responsible for connecting the optional equipment to the I/O signal port shall be responsible for medical system configuration and system compliance with IEC 60601-1.
- WARNING:** This machine must only be operated by trained, skilled medical staff.
- WARNING:** Before putting the system into operation, the operator must verify that the equipment, connecting cables, and accessories are in correct working order and operating condition.
- WARNING:** The equipment must be connected to a properly installed power outlet with protective earth contacts only. If the installation does not provide for a protective earth conductor, disconnect it from the power line or operate from the equipment's internal battery supply.
- WARNING:** Multiple AC power outlets are provided on the rear of the A5/A3. These outlets are intended to supply power to additional equipment that form a part of the anesthesia system (i.e. vaporizers, gas analyzers, etc.). Do not connect other equipment to these outlets, as patient leakage current may be affected. Each outlet is rated 3 A; the total current that may be drawn through all outlets is 10 A on the A5 System and 9 A on the A3 System; do not attempt to exceed these load ratings. Do not connect additional Multiple Portable Socket Outlets (i.e. Multiple outlet extension cords) (MPSOs) or extension cords to these outlets.
- WARNING:** Do not put MPSOs on the floor.
- WARNING:** Connect the A5/A3 Anesthesia System to an AC power source before the internal battery power source is depleted.
- WARNING:** Do not open the equipment housings. All servicing and future upgrades must be carried out only by trained and authorized Mindray personnel.
- WARNING:** Do not rely exclusively on the audible alarm system for patient monitoring.
- WARNING:** Adjustment of alarm volume to a low level may result in a hazard to the patient.
- WARNING:** Alarm settings should be customized according to different patient situations. Constantly keeping the patient under close surveillance is the most reliable way for safe patient monitoring.
- WARNING:** The physiological parameters and alarm messages displayed on the screen of the equipment are for the caregiver's reference only and cannot be directly used as the basis for clinical treatment.
- WARNING:** Dispose of the packaging material, observing the applicable waste control regulations and keeping it out of children's reach.

- WARNING:** To avoid the possibility of explosion, do not use the equipment in the presence of flammable anesthetic agents, vapors or liquids. Do not use flammable anesthetic agents such as ether and cyclopropane for this equipment. Use only non-flammable anesthetic agents that meet the requirements specified in ISO 80601-2-13. The A5/A3 Anesthesia System can be used with halothane, enflurane, isoflurane, sevoflurane, and desflurane. Only one anesthetic agent can be used at a time.
- WARNING:** Fresh gas flow must never be switched off before the vaporizer is switched off. The vaporizer must never be left switched on without a fresh-gas flow. Anesthetic agent vapor at a high concentration can get into the machine lines and ambient air, causing harm to people and materials.
- WARNING:** To avoid the risk of electric shock, this equipment must only be connected to a supply mains with protective earth.
- WARNING:** The use of anti-static or electrically conductive breathing tubes, when utilizing high frequency electric surgery equipment, may cause burns, and is therefore not recommended in any application of this machine.
- WARNING:** Possible electric shock hazard. The machine may only be opened by authorized service personnel.
- WARNING:** The patient should be visually monitored by qualified personnel. In certain situations, life-threatening circumstances may occur that may not necessarily trigger an alarm.
- WARNING:** Always set the alarm limits so that the alarm is triggered before a hazardous situation occurs. Incorrectly set alarm limits may result in operating personnel not being aware of drastic changes in the patient's condition.
- WARNING:** Connection of both medical and non-medical equipment to the auxiliary mains socket outlet (s) may increase the leakage currents to values exceeding the allowable limits.
- WARNING:** Electric shock and fire hazard: Do not clean the machine while it is powered on and/or plugged into an outlet.
- WARNING:** Disconnect the power plug from the mains supply before removing the rear panels or servicing the A5/A3 unit.
- WARNING:** Malfunction of the central gas supply system may cause more than one or even all devices connected to it to stop their operation simultaneously.
- WARNING:** The anesthesia system will cease to deliver gas at pressures below the minimum specified gas pipeline supply pressure.
- WARNING:** Use a cleaning and disinfection schedule that conforms to your institution's disinfection and risk-management policies.
- Refer to the material safety data sheet as applicable.
 - Refer to the operation and maintenance manuals of all disinfection equipment.
 - Do not inhale fumes that may result from any disinfection process.
- WARNING:** Use extreme care while handling the absorbent as it contains a caustic irritant.

-
- WARNING:** Use care in lifting and manipulating vaporizers during the mounting process as their weight may be greater than expected, based on their size and shape.
- WARNING:** Do not use talc, zinc stearate, calcium carbonate, corn starch, or similar material to prevent sticking of the bellows, as these materials may enter the patient's lungs or airway, causing irritation or injury.
- WARNING:** All gas supplies should be of medical grade.
- WARNING:** Single use respiratory hoses, face masks, sensors, sodalime, water traps, sampling lines, airway adapters, and other single use items may be considered potential biologically hazardous items and should not be reused. Dispose of these items in accordance with hospital policy and local regulations for contaminated and biologically hazardous items.
- WARNING:** To avoid endangering a patient, do not perform testing or maintenance when the machine is in use.
- WARNING:** Review the performance specifications of the disposal system that the transfer and receiving systems are intended to be used with, to ensure compatibility.
- WARNING:** The A5/A3 should not be used adjacent to or stacked with other equipment. If adjacent or stacked use is necessary, the A5/A3 should be observed to verify normal operation in the configuration in which it will be used.
- WARNING:** Ensure that the current alarm presets are appropriate before use on each patient.
- WARNING:** A hazard can exist if different alarm presets are used for the same or similar equipment in any single area.
- WARNING:** Due to the size and weight of the A5/A3, it should only be moved by qualified personnel.
- WARNING:** Overloading machine may cause tipping. Equipment attached to the side of the machine should fall within the rated weights to prevent tipping of the machine.
- WARNING:** Excess load may cause a tip hazard while moving the A5/A3. Before moving, remove all equipment from the top shelf and all monitoring equipment mounted to the side of the A5/A3. Use care when moving the A5/A3 up or down inclines, around corners, and across thresholds. Do not attempt to roll the A5/A3 over hoses, cords, or other obstacles.
- WARNING:** Leaks or internal venting of sampled gas may affect accuracy. Perform the proper preoperative tests to ensure that the device is performing properly. Leaky circuits can not be used.
- WARNING:** Connection of the A5/A3 exhaust port to the hospital's waste gas scavenging system is strongly recommended to prevent exposure of hospital personnel to the A5/A3 exhaust gases.
- WARNING:** Operation of the A5/A3 below the minimum flow values may cause inaccurate results.
- WARNING:** Ensure that an independent means of ventilation (e.g. a self-inflating manually powered resuscitator with mask) is available whenever the A5/A3 is in use.

-
- WARNING:** Usage of accessories found with damaged packaging may cause biocontamination or failure. The operator should check accessory packaging integrity before use.
- WARNING:** Before using the A5/A3 System (after cleaning or disinfecting), power up the system and follow the on-screen prompts to perform the leak test and the compliance test. (see section 4.5 (page 4-9) "Leak and Compliance Tests".)
- WARNING:** Improperly cleaned materials may result in biocontamination. Use a cleaning and disinfection schedule that conforms to your institution's disinfection and risk-management policies.
- Refer to the material safety data as applicable.
 - Refer to the operation and maintenance manuals of all disinfection equipment.
- The user should follow the recommended disinfection routine for this machine and any reusable accessories.
- WARNING:** If the A5/A3 is damaged in any way that compromises the safety of the patient or user, discontinue use and attach a visible tag that marks the A5/A3 as unusable. Call Mindray Technical Support.
- WARNING:** Oxygen, when present in high concentrations, can significantly increase the chance of fire or an explosion. Oil and grease may spontaneously ignite and should not be used where oxygen enrichment may occur.
- WARNING:** Use of lubricants not recommended by Mindray may increase the danger of fire or explosion. Use lubricants approved by Mindray.
- WARNING:** Low-pressure regulators and flow-meters are susceptible to high pressure, and may burst if improperly maintained or disassembled while under pressure. Changing connectors or disassembling should be performed only by qualified personnel.
- WARNING:** Do not disassemble the low-pressure regulator, flow-metering device, or connector while under pressure. The release of sudden pressure may cause injury.
- WARNING:** Review the specifications of the AGSS transfer and receiving systems and the specifications of the A5/A3 System to ensure compatibility and to prevent a mismatched receiving system.
- WARNING:** Avoid connecting two or more hose assemblies in series as this may cause a loss of pressure and flow.
- WARNING:** A hazard may exist due to the use of improper connectors. Ensure all assemblies use the proper connectors.
- WARNING:** Avoid replacing a high-pressure flexible connection with one of lower nominal inlet pressure.
- WARNING:** Reusing breathing circuits or reusable accessories that are not disinfected may cause cross-contamination. Disinfect the breathing circuits and reusable accessories before use.
- WARNING:** Inspect all breathing system components carefully before each use. Ensure all components do not contain any obstructions or debris that can cause a potential hazard to the patient.
- WARNING:** Use breathing circuits and manual bags in accordance with ASTM F1208 and compatible with standard 22mm male conical fittings per ASTM specifications F 1054.

-
- WARNING:** The mains plug is used to isolate the Anesthesia System circuits electrically from the SUPPLY MAINS. Do not position the Anesthesia System so that it is difficult to operate the plug.
- WARNING:** Do not touch the patient when connecting the peripheral equipment via the I/O signal ports or replacing the oxygen cell to prevent patient leakage current from exceeding the requirements specified by the standard.
- WARNING:** If the Drive Gas Pressure Low alarm occurs when the gas supply pressure is greater than 200 kPa, contact your service personnel or us.
- WARNING:** The anesthesia system shall not be serviced or maintained while being connected on a patient.
- WARNING:** Additional MULTIPLE SOCKET- OUTLET or extension cord shall not be connected to the ME SYSTEM.

Cautions

- CAUTION:** To ensure patient safety, use only parts and accessories specified in this manual.
- CAUTION:** At the end of its service life, the equipment, as well as its accessories, must be disposed of in compliance with the guidelines regulating the disposal of such products, and in accordance with local regulations for contaminated and biologically hazardous items.
- CAUTION:** Magnetic and electrical fields are capable of interfering with the proper performance of the equipment. Ensure that all external devices operating in the vicinity of the equipment comply with the relevant EMC requirements. Mobile phones, x-ray equipment, and MRI devices are possible sources of interference as they may emit higher levels of electromagnetic radiation.
- CAUTION:** This system operates correctly at the electrical interference levels identified in this manual. Higher levels can cause nuisance alarms that may stop mechanical ventilation. Be aware of false alarms caused by high-intensity electrical fields.
- CAUTION:** The A5/A3 Anesthesia System may become unstable if the unit is tilted beyond 10 degrees. Use extreme caution when moving or resting the unit on surfaces exceeding a 10 degree slope. Do not hang articles on the sides of the unit that would cause an excessive imbalance.
- CAUTION:** Perform the daily checks specified on the checklist. In case of a system fault, do not operate the system until the fault has been corrected.
- CAUTION:** Before starting the machine, users must be familiar with the information contained in these Operating Instructions and must have been trained by an authorized representative.
- CAUTION:** If the machine does not function as described, it must be examined and repaired as necessary by qualified service personnel before being returned to use.
- CAUTION:** Handle the machine with care to prevent damage or functional faults.
- CAUTION:** Ensure that the gas supply of the machine always complies with the technical specifications.

-
- CAUTION:** Before clinical use, the machine must be correctly calibrated and/or the respective tests must be performed, as described in these Operating Instructions.
- CAUTION:** If system faults occur during the initial calibration or testing, the machine should not be operated until those faults have been corrected by a qualified service person.
- CAUTION:** After servicing, functional, sensor, and system tests must be performed before clinical use.
- CAUTION:** Only vaporizers with Selectatec Interlock-Systems may be used with the A5/A3 unit.
- CAUTION:** After each exchange of a vaporizer, perform a vaporizer leak test.
- CAUTION:** Use cleaning agent sparingly. Excess fluid could enter the machine, causing damage.
- CAUTION:** Do not autoclave any parts of the A5/A3 unless specifically identified as autoclavable in this manual. Clean the A5/A3 only as specified in this manual.
- CAUTION:** To prevent system damage:
- Refer to the literature supplied by the manufacturer of the cleaning agent.
 - Never use organic, halogenated or petroleum-based solvents, anesthetics, glass cleaning agents, acetone or other irritant agents.
 - Never use abrasive agents (i.e. steel wool or silver polish) to clean components.
 - Keep all liquids away from electronic components.
 - Prevent liquid from entering the equipment.
 - All cleaning solutions used must have a pH between 7.0 and 10.5.
- CAUTION:** Never immerse the oxygen sensor or its connector in any type of liquid.
- Dispose of the oxygen sensor as per the local regulations.
- CAUTION:** Do not use acetic hydroperoxide or formaldehyde steaming.
- CAUTION:** The valve disc in each of the inhalation and exhalation valve assemblies on the breathing system is fragile and must be handled with care while removing the valve cage from the valve assembly.
- CAUTION:** If moisture remains in the bellows after cleaning, the bellows surface folds may become tacky and prevent the bellows from properly expanding. Ensure all moisture is removed from the bellows after cleaning.
- CAUTION:** Only connect Mindray approved equipment to the A5/A3 communication ports. Equipment connected to the A5/A3 ethernet ports must comply with IEC 60950.
- CAUTION:** Do not connect any non-isolated devices to the DB9/RS232C interface of the A5/A3.
- CAUTION:** Do not connect any devices to the SB ports other than Mindray approved USB storage devices and a supported USB mouse (see "Networking and USB Storage" on page A-4).

-
- CAUTION:** Do not wash the inner surface of the oxygen sensor.
- CAUTION:** Do not autoclave the following components: Paw gauge, oxygen sensor, flow sensor, and bellows. These components cannot withstand immersion or the heat and pressure of autoclaving.
- CAUTION:** Users should monitor oxygen percentage (FiO₂%) when using the Auxiliary O₂/Air Flow Meters. Unknown oxygen concentrations may be delivered to the patient unless oxygen monitoring is used.
- CAUTION:** The A5/A3 is NOT suitable for use in a magnetic resonance imaging (MRI) environment.
- CAUTION:** To ensure measurement accuracy and to avoid possible damage to the A5/A3, use only Mindray-approved cables and accessories.
- CAUTION:** Use the power cord provided with the product. If a substitute is necessary, use only hospital grade power cords.
- CAUTION:** Do not use a damaged or broken unit or accessory. Periodically check all cables (e.g., AC line cord and patient connection cables) for damage that may occur through normal use. Replace cables if damaged in any way.
- CAUTION:** Use of other oxygen sensors may cause improper oximeter performance.
- CAUTION:** Unintended movement may occur if the casters are not locked. The operator should lock casters during use of the machine.
- CAUTION:** Unsecured devices may slide off the top shelf. Devices should be securely attached to the top shelf.
- CAUTION:** The voltage on the auxiliary outlets is the same voltage as the outlet into which the A5/A3 machine is plugged. Ensure that devices plugged into the auxiliary outlets are rated for the same supply voltage as the A5/A3.
- CAUTION:** During the transport and storage of the vaporizer, block the gas inlet and outlet of the vaporizer with plugs to prevent foreign substances from entering the vaporizer.
- CAUTION:** Do not use any flow outlets as handles for moving the A5/A3. The flow outlets may become damaged. Use the metal side bars on the main body when moving the A5/A3.
- CAUTION:** Do not push down on the bag arm forcefully or hang heavy objects onto it. Excessive weight may bend and damage the bag arm.
- CAUTION:** Use caution when disconnecting "quick connectors", as the sudden release of pressure may cause injury.
- CAUTION:** Avoid factors that can contribute to deterioration of the hose assemblies. Factors include excessive bending, crushing, abrasion, system pressures and temperatures that exceed hose ratings, and improper installation.
- CAUTION:** Use care in lifting and manipulating the breathing system block during removal from its mounting arm as handling may be awkward due to its weight and shape.

CAUTION: Turn the flow controls slowly. To avoid damaging the control valves, do not turn further when the flowmeter reading is outside the range. When turning a flow control knob clockwise to decrease flow, the flowmeter should reach zero before the knob reaches its most clockwise mechanical stop (Off) position. Do not turn any further when the knob has reached the Off position.

Similarly, when turning a flow control knob counterclockwise to increase flow from zero, the flowmeter reading should not indicate a change from zero until the flow control knob is turned approximately one (1) rotation counterclockwise from the Off position, and only if permitted according to the gas ratio control system.

Notes

- NOTE:** Figures in this manual are provided for reference purposes only. Screens may differ based on the system configuration and selected parameters.
- NOTE:** Put the equipment in a location where you can easily see the screen and access the operating controls.
- NOTE:** Keep this manual close to the equipment so that it can be obtained conveniently when needed.
- NOTE:** The software was developed in compliance with IEC 60601-1. The possibility of hazards arising from software errors is minimized.
- NOTE:** This manual describes all features and options. Your equipment may not have all of them.
- NOTE:** The A5/A3 is intended to be operated with its integral Breathing Pressure monitoring in use.
- NOTE:** The A5/A3 is intended to be operated with its integral Breathing Pressure limitation devices in use.
- NOTE:** The A5/A3 is intended to be operated with its integral Exhaled Volume monitoring in use.
- NOTE:** The A5/A3 is intended to be operated with its integral Breathing System integrity Alarm System in use.
- NOTE:** The A5/A3 is intended to be operated with its integral Continuing Pressure Alarm in use.
- NOTE:** The A5/A3 is intended to be operated with its integral O₂ monitoring in use.
- NOTE:** The A5/A3 is intended to be operated with an external CO₂ monitor complying with ISO 80601-2-55. Connection to the CO₂ monitor should be via a sample line from the patient circuit.
- NOTE:** The Anesthesia Vapor Delivery Device is to be used with an Anesthetic Agent Monitor complying with ISO 80601-2-55. Connection to the Agent monitor should be via a sample line from the Patient Circuit.
- NOTE:** Continuously monitor the anesthetic agent concentration when using the Anesthesia System to ensure accurate output of the anesthetic agent.

-
- NOTE:** Check the liquid level of the anesthetic agent before and during all operations. When the liquid level is below the warning line, more anesthetic agent needs to be added. Refer to the vaporizer Instructions For Use for filling the vaporizer and other information.
- NOTE:** The A5/A3 System is designed to be equipped with an anesthetic vapor delivery device that complies with ISO 80601-2-13.
- NOTE:** The A5/A3 battery supply is not a user serviceable component. Only an authorized service representative can replace the battery supply. If the system is not used for an extended period, contact a service representative to have the battery supply disconnected. The batteries may be subject to local regulations regarding disposal. At the end of the battery life, dispose of the battery supply in accordance with local regulations.
- NOTE:** Areas designated for the servicing of oxygen equipment shall be clean, free of oil and grease, and not used for the repair of other equipment.
- NOTE:** Opening the cylinder valve quickly may cause unexpected pressure differentials and create a potential for fire or explosion arising from oxygen pressure shocks. Open and shut the cylinder valve slowly.
- NOTE:** Accuracy of the flowrate may be affected by varying inlet pressure, varying outlet resistance, or varying ambient temperature.
- NOTE:** The power device, terminal units and pipeline system can be supplied by one or several different manufacturers.
- NOTE:** Regional or national regulations that apply to manufacturers of medical devices can exist.
- NOTE:** For the method of connecting A5 to external monitor or other devices, please see Anesthesia Machine Bracket Installation Instructions.
- NOTE:** The A5 can be equipped with one scavenger system to provide the best match with the hospital's waste-gas disposal system. The scavenger system shall comply with ISO 80601-2-13.
- NOTE:** The Anesthesia System is compatible with gases (O₂, N₂O, and Air) and anaesthetic agents (Halothane, Enflurane, Isoflurane, Sevoflurane, and Desflurane).
- NOTE:** The leakage of AGSS is measured by the method recommended in ISO 80601-2-13.

Warranty Statements

Mindray DS USA, Inc. warrants that components within the anesthesia system will be free from defects in workmanship and materials for the number of years shown on the invoice. Under this extended warranty, Mindray DS USA, Inc. will repair or replace any defective component at no charge for labor and/or materials. This extended warranty does not cover consumable items such as (but not limited to) batteries and external cables.

Calibration may be performed without the need to disassemble the instrument. It is the responsibility of the purchaser to perform calibration as necessary, in accordance with the instructions provided in this manual.

Recommended preventative maintenance, as prescribed in the Maintenance section of this manual, is the responsibility of the user, and is not covered by this warranty.

Except as otherwise provided herein, the terms, conditions, and limitations of Mindray DS USA, Inc.'s standard warranty will remain in effect.

Mindray DS USA, Inc. warrants that its products will be free from defects in workmanship and materials for a period of one (1) year from the date of purchase except that disposable or one-time use products are warranted to be free from defects in workmanship and materials up to a date one year from the date of purchase or the date of first use, whichever is sooner. This warranty does not cover consumable items such as, but not limited to, batteries, external cables, O₂ sensors, CO₂ absorbents, breathing circuits, hoses, or mounts.

Mindray DS USA, Inc. will not be liable for any incidental, special, or consequential loss, damage, or expense directly or indirectly arising from the use of its products, liability under this warranty and the buyer's exclusive remedy under this warranty is limited to servicing or replacing at Mindray DS USA, Inc.'s option at the factory or at an authorized distributor, any product which shall under normal use and service appear to the Company to have been defective in material or workmanship.

No agent, employee, or representative of Mindray DS USA, Inc. has any authority to bind Mindray DS USA, Inc. to any affirmation, representation, or warranty concerning its products, and any affirmation, representation or warranty made by any agent, employee, or representative shall not be enforceable by buyer.

This warranty is expressly in lieu of any other express or implied warranties, including any implied warranty or merchantability or fitness, and of any other obligation on the part of the seller.

Damage to any product or parts through misuse, neglect, accident, or by affixing any non-standard accessory attachments or by any customer modification voids this warranty. Mindray DS USA, Inc. makes no warranty whatsoever in regard to trade accessories, such being subject to the warranty of their respective manufacturers.

A condition of this warranty is that this equipment or any accessories which are claimed to be defective be returned when authorized, freight prepaid to Mindray DS USA, Inc., Mahwah, New Jersey 07430. Mindray DS USA, Inc. shall not have any responsibility in the event of loss or damage in transit.

Disclaimers

Product Improvements — Mindray DS USA, Inc. retains the right to modify the machine and/or operating instructions without prior notification. These operating instructions explain all features of the A5/A3 System and are correct at time of manufacture. Instructions and models produced at a later stage, may contain improvements or modifications that were not included in previous models.

Phone Numbers and How To Get Assistance

A network of service representatives and factory-trained distributors is available. Prior to requesting service, perform a complete operational check of the instrument to verify proper control settings. If operational problems continue to exist, contact the Service Department at (800) 288-2121, ext: 8116 for Technical Support or (201) 995-7875 for assistance in determining the nearest field service location.

Please include the instrument model number, the serial number (located on the back of the A5/A3), and a description of the problem with all requests for service.

Warranty questions should be directed to a local representative. A list of offices, along with their phone numbers, is provided at the end of this manual.

NOTE: **Upon request, calibration instructions or other information will be provided to assist the user's appropriately qualified technical personnel in repairing those parts of the A5/A3 which are designated as repairable.**

Manufacturer's Responsibility

The effects on safety, reliability, and performance of the equipment are the manufacturer's responsibility only if:

- a. assembly operations, extensions, readjustments, modifications or repairs are carried out by authorized personnel; and
- b. the electrical installation of the relevant room complies with the appropriate requirements; and
- c. the equipment is used in accordance with the instructions for use









Manufacturer and Address









Manufacturer: Shenzhen Mindray Bio-Medical Electronics Co., Ltd.

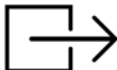





















Address: Mindray Building, Keji 12th Road South, High-tech industrial park, Nanshan, Shenzhen 518057, P.R. China

Symbols

The following table provides descriptions of symbols that are used on the device and/or within this manual.

SYMBOL	DESCRIPTION	SYMBOL	DESCRIPTION
	Caution		Environment: Temperature Range
	Defibrillator proof type BF equipment		Environment: Humidity Range
	Electrical: Alternating Current (AC)		Environment: Pressure Range
	Electrical: Equipotentiality		Gas Cylinder

	Electrical: Fuse or circuit breaker		Gas Inlet
	Electrical: Input Output		Gas Outlet
	Electrical: Internal Battery		Gas Flow: Flow Control
	Electrical: Light	MAX	Gas Flow: Maximum
	Electrical: Power On	MIN	Gas Flow: Minimum
	Electrical: Power Standby		Gas Flow Total
	Electrical: Protective Earth (Ground)	O₂+	Gas: O ₂ Flush
	Electrical: WEEE (Waste of Electrical and Electronic Equipment) Marking. Separate treatment from general waste at end of life.	O₂%	O ₂ Sensor Connector
	Identifier: Manufacturer		Gas Pipeline Connection
REF	Identifier: Manufacturer's Reference/Catalog Number	>PPSU<	Material: Polyphenyl-sulfone
SN	Identifier: Serial Number Indicator	>PSU<	Material: Polysulfone
	Lock/Unlock: Direction		Touchpad
	Lock/Unlock: Lock		Manual ventilation via Breathing Bag
	Lock/Unlock: Unlock		Automatic Ventilation

	No Heavy Objects Do Not Crush		Water Trap
134°C	Autoclavable		Do Not Oil
	Not Autoclavable		Filter Access
	Caution: Hot		Direction of flow
	Water Drain		Drawer weight limit 5 kg MAX 11 lbs MAX
	MR Unsafe - do not subject to magnetic resonance imaging (MRI)		ETL CLASSIFIED Conforms to AAMI Std. ES 60601-1, IEC Std.60601-1-8, ISO Std. 80601-2- 13, ISO Std. 80601-2-55. Certified to CSA Std. C22.2 No. 60601- 1, CSA Std. C22.2 No.60601-1-8, ISO Std. 80601-2-13, ISO Std. 80601-2-55.
	Canister opened		Canister closed
	Maximum pressure of max 125 cmH ₂ O ACGO separate outlet		Refer to instruction manual/booklet
	Warning		IPX1 Protection against vertically falling water drops
	Battery supply fully charged. AC power connected and powering system.		Alarm Icon
	Battery supply partially charged. AC power connected, charging battery supply, and power system.		Alarm Silence Icon
	Battery supply fully charged and powering system. AC power not connected.		Low priority message



Battery supply partially charged and powering system. AC power not connected.



Medium priority message



Battery supply low charged and powering system. Recharging recommended. AC power not connected.

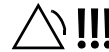

High priority message



Battery supply not installed.



Breathing System Warmer Off

This page intentionally left blank.

1.0

Product Description

General System Overview	1-2
Physical Views	1-9

1.1 General System Overview

1.1.1 General Description

The A5/A3 Anesthesia System is a device intended to administer, continuously or intermittently, a general inhalation anesthetic to a patient, and to maintain a patient's ventilation. The A5/A3 also provides for ventilatory monitoring of the patient. The anesthesia system is intended to be used in the patient environment.

The A5/A3 Anesthesia System consists of a main unit (includes an anesthetic ventilator and flowmeter monitor assembly) and a detachable breathing system. The applied part of the anesthesia system are breathing tubes and masks. Connect the patient to the anesthesia system via breathing tubes and masks.

The A5 Anesthesia System provides the following ventilation modes:

- Volume Control Ventilation (VCV), which includes the Pressure Limit Ventilation (PLV) function
- Pressure Control Ventilation (PCV) with/without Volume Guarantee (VG) ventilation mode
- Synchronized Intermittent Mandatory Ventilation (SIMV) with VC mode (with/without PS option)
- Synchronized Intermittent Mandatory Ventilation (SIMV) with PC mode (with/without PS option)
- Pressure Support (PS) ventilation mode
- Spontaneous ventilation in Manual mode with APL fully open
- Manual Ventilation through the use of a breathing bag
- Cardiac Bypass mode
- Monitor Mode

The A3 Anesthesia System provides the following ventilation modes:

- Volume Control Ventilation (VCV), which includes the Pressure Limit Ventilation (PLV) function
- Pressure Control Ventilation (PCV)
- Synchronized Intermittent Mandatory Ventilation (SIMV) with VC mode (with/without PS option)
- Pressure Support (PS) ventilation mode
- Spontaneous ventilation in Manual mode with APL fully open
- Manual Ventilation through the use of a breathing bag

Electronic PEEP is available in all automatic ventilation modes. User control of the inspiratory flow rise (Tslope) is possible in PCV, SIMV, and PS modes. Automatic fresh gas compensation limits the effect on the patient ventilation from changes in fresh gas flow rate by the operator. The traditional bellows system is driven by oxygen and makes patient disconnections clearly visible.

The A5/A3 Anesthesia System provides the following common functions:

- Automatic leak detection
- Circuit gas leakage compensation and automatic compliance compensation
- Cylinder and central pipeline gas supply connections available for gas input
- Electronically displayed flowmeter and electronically adjustable PEEP
- Electronic timer to display the duration between the start and end of an operation
- Work table light
- Mounting rails to connect an external patient monitor

- Network-ready
- Flow trigger mode available for PS and SIMV
- Auxiliary O₂ and air supply
- Active AGSS or optional Passive scavenging
- N₂O cutoff
- Cardiac Bypass alarm mode.
- DEMO
- Vaporizer
- Total flow rotameter
- AG module
- Monitor mode

1.1.2 Key Features

FEATURE	DESCRIPTION
Display	15 inch color LCD with touchscreen.
Navigation	Graphical user interface for easy navigation.
Ventilation	Manual and automatic ventilation modes and monitoring: VCV, SIMV-VC, PCV, SIMV-PC (A5 only), PS, and Manual.
Fresh Gas Delivery	Continuous and intermittent anesthesia flow, total flow rotameter, virtual dual flow tubes, electronically displayed on screen for ease of use. 3 cylinder mount locations on rear.
Breathing System	Heated, adjustable swivel, side hose ports, single turn APL valve.
Ergonomics	Large stainless steel work surface. Adjustable breathing system block via swivel up to 50 degrees.
Electronic PEEP	Positive End Expiratory Pressure (PEEP) is set and controlled electronically.
Clear Data Display	Two large waveforms for pressure and flow or Spirometry Loops (A5 only).
USB Mouse Support	The A5/A3 system supports a wired USB mouse, which can be plugged into one of the two SB ports at the rear of the unit. A cursor appears when the mouse is plugged. The cursor disappears if the user touches the screen or after 15 seconds of mouse inactivity. A3: The USB mouse can serve as a backup to the touchscreen. A5: The USB mouse can serve as a backup to both the touchscreen and touchpad.

1.1.3 Fresh Gas Dosing

The A5/A3 fresh gas dosing subsystem offers the following features:

- Virtual On-Screen dual flow tube and numerical readouts to display the O₂, N₂O, and Air flows
- A knob guard to prevent inadvertent movement of the flow control knobs
- Gas supply gauges to indicate the gas pipeline supply pressures and gas cylinder pressures
- Mechanical total flowmeter to display the combined flow of O₂, Air, and N₂O
- An O₂ flush button
- A single auxiliary combined output with O₂ and Air flowmeters

Safety systems within the A5/A3 work to prevent hypoxic mixtures from being delivered to the patient. Nitrous oxide will not be delivered unless oxygen flow is present. A pneumatic safety system assures that at least 21% O₂ is present when setting mixtures of O₂ and N₂O. Additionally, if the A5/A3 is placed in the standby mode, O₂ fresh gas flow is not available.

WARNING: Ensure that both O₂ and N₂O flow controllers are turned OFF fully at the start and at the end of each case.

All A5/A3 units are designed to maintain a safe O₂:N₂O ratio by allowing nitrous oxide to be set to a flow rate that is proportional to a previously adjusted flow of oxygen. The N₂O flow is limited by the flow of O₂ so that a safe ratio of no less than 21% oxygen can be maintained. The A5/A3 is designed to maintain oxygen flow at its previously set level when N₂O is decreased.

When adjusting N₂O and O₂ flow rates, always adjust the oxygen flow first to enable the nitrous oxide flow. To add N₂O to the fresh gas flow, open the N₂O flowmeter valve, but only after opening the O₂ flowmeter valve.

1.1.4 Flow Control

Flow Control needle Valve and Knob:

Three independent flow control knobs allow setting the input flow rates of N₂O, Air, and O₂ into the fresh gas flow.

N₂O Automatic Cutoff:

An N₂O automatic cutoff valve stops the flow of N₂O if O₂ flow is less than 200 ml/min.

O₂ Pressure Loss Alarm:

An O₂ pressure loss alarm announces when oxygen pressure is less than 220 kPa (32 psi).

Oxygen Ratio Controller:

An O₂ ratio controller ensures that there is always at least 21 % oxygen concentration in the fresh gas flow when N₂O is fully open.

1.1.4.1 Flow/Pressure Sensing

The breathing system block contains patient flow and pressure sensors to measure inspiratory flow, expiratory flow, and inspiratory pressure. These sensors enable spirometry as well as standard pressure and flow monitoring.

1.1.5 Vaporizer Mounting

The A5/A3 contains a 2-position Selectatec-type vaporizer mounting system to enable anesthetic agents to be introduced into the fresh gas flow. The mounting system adapts vaporizers with interlock, which permits only one agent at a time to be administered. Lighting above the vaporizers enables them to be seen in a dim light environment. Maximum three vaporizers can be mounted at any one time. The A5 and A3 comes standard with a two vaporizer mount. Third vaporizer mount is optional. Halothane, Enflurane, Isoflurane, Desflurane, and Sevoflurane vaporizers can be used.

For the A5 model, additional, non-functional vaporizer parking spot on the side of the unit is provided as part of the standard configuration.

1.1.6 Anesthesia Ventilator

The A5/A3 ventilator offers multiple ventilation modes: Volume Control Ventilation (VCV), Synchronized Intermittent Mandatory Ventilation-Volume Control (SIMV-VC), Pressure Control Ventilation (PCV), Pressure Support (PS) ventilation, and Manual ventilation.

The A5 offers additional ventilation modes, which include Pressure Control Ventilation (PCV) with and without Volume Guarantee (VG), and Synchronized Intermittent Mandatory Ventilation-Pressure Control (SIMV-PC).

1.1.7 Breathing System

A portion of the patient circuit is integrated into an assembly block called the breathing system. The system contains a temperature controller, which warms the block to a temperature of 35°C typical at 20°C ambient temperature to limit the formation of water condensate. The breathing system can be swiveled horizontally up to 50 degrees for user convenience.

The breathing system provides access to the APL valve and breathing bag along with a view of the airway pressure gauge. The APL valve has a single turn knob that provides a clear view of the manual breathing pressure setting. The absorber assembly incorporates a cam-lock device that opens and closes to provide access to the absorber canister. Either a Pre-Pak or loose fill CO₂ absorbent can be used. Two water traps that can be drained are located on the CO₂ absorber assembly and on the breathing system block.

NOTE: Operating the A5/A3 with a full water trap in the breathing system block does not allow the water to condense appropriately. The trap should be removed and emptied when filled with water.

Two (2) flow sensors in the breathing system measure inspired and expired gases for control and monitoring. Inspired oxygen concentration is monitored via a fuel-cell type sensor. Breathing pressure is monitored with both a PAW gauge (mechanical) and electronic gauge. The breathing system can be swiveled for ease of positioning. A leak test port is provided to allow for leak testing during startup.

The main pneumatic components of the breathing system are as follows:

- Inspiratory Valve (passive)
- Expiratory Valve (passive)
- Airway Pressure Limiting Valve (APL)
- Connection for O₂ Sensor
- CO₂ Absorber Assembly
- Bellows Assembly
- Auto/Manual bag switch
- Bag arm
- PAW Gauge

The breathing system connects to the A5/A3 main unit through the following ports:

- Drive gas port, designed for use with oxygen as the drive gas
- Fresh gas port
- Exhaust gas port
- Flow sensor pressure transmission pipeline port

The breathing system contains the following ports for end-user connections:

- Inspiratory port for Inspiratory hose of patient breathing circuit
- Expiratory port for Expiratory hose of patient breathing circuit
- Manual Breathing Bag Arm
- Connection for the O₂ cell
- Water trap
- Leak test port for sealing the breathing circuit during leak testing

1.1.8 Active Anesthetic Gas Scavenging System (AGSS)

The A5/A3 includes a waste gas scavenger that attaches to the side rail mount on the system. The A5/A3 provides a port for the connection of the waste line from an anesthetic gas monitor.

1.1.9 Passive Anesthetic Gas Scavenging System (AGSS)

The A5/A3 includes a passive waste gas scavenger. The inlet port of the scavenger connects with the AGSS port and the exhaust port connects with the hospital's waste gas scavenging system.

1.1.10 Power Management / Battery Supply

The advanced power management system of the A5/A3 provides AC power for main system functions while charging the system's internal battery supply. During AC power failure, the A5/A3 will operate on battery power for a minimum of 75 minutes with one (1) new battery installed (A3) or 150 minutes with two (2) new batteries installed (A5). See "Battery Power Specifications" on page 9-7.

A recessed main switch is provided to power the system On and to put the system on power standby where the battery supply continues to charge as necessary when the A5/A3 is plugged into an external power source. The main switch also stops the O₂ fresh gas supply when the A5/A3 is placed in Power Standby mode.

Auxiliary AC outlets on the rear of the machine operate independently of the main switch position. The A5 provides four (4) auxiliary AC outlets; the A3 provides three (3) auxiliary AC outlets. The auxiliary AC outlets are not powered when operating the A5/A3 on the internal battery supply.

NOTE: Use the battery supply in the A5/A3 at least once every month to extend battery life. Charge the battery supply before its power capacity is depleted.

NOTE: Inspect and replace the battery supply at regular service intervals. Long-term battery life depends on how frequent and how long the battery supply is used. For a properly maintained and stored lithium-ion battery, its long-term life expectancy is approximately three (3) years. In more aggressive usage, life expectancy can be shortened. Replacing lithium-ion batteries every three (3) years is recommended.

NOTE: The operating time of a battery depends on equipment configuration and operation.

NOTE: In case of battery failure, contact Mindray service personnel for battery supply replacement.

CAUTION: Please replace your battery when it reaches the end of its service life. Failure to replace the battery may cause serious damage to your device from battery overheating.

The A5/A3 Anesthesia System is designed to operate on battery power whenever AC power is interrupted. When the A5/A3 is connected to an AC power source, the battery supply is charged whether or not the A5/A3 is turned on. In case of power failure, the A5/A3 will automatically switch to run from the internal battery supply. When AC power source is restored within the specified time, the battery supply begins recharging, and power is switched from battery to AC automatically to ensure continuous system use.

When power is lost for less than or equal to 60 s, the alarm settings prior to the power loss shall be restored automatically.

The on-screen battery symbol indicates the battery status (see FIGURE 1-1).





PART(S)	DESCRIPTION
	Battery supply is fully charged. AC power is connected. The A5/A3 is being powered by AC power.
	Battery supply is partially charged. AC power is connected and charging battery supply. The A5/A3 is being powered by AC power. The solid portion represents the current charge level of the batteries in proportion to its maximum charge level.
	Battery supply is fully charged. AC power is not connected. The A5/A3 is being powered by internal battery supply.
	Battery supply is partially charged. AC power is not connected. The A5/A3 is being powered by internal battery supply.
	Battery supply is low charged. Batteries need to be charged immediately to operate as a safe power backup. AC power is not connected. The A5/A3 is being powered by internal battery supply.
	Battery supply is not installed.

FIGURE 1-1 Battery Status

If the battery capacity is too low, power supply failure will result. A high-level alarm will be triggered and the message **Low Battery Voltage!** will be displayed in the technical alarm area. In this case, apply AC power to the A5/A3 Anesthesia System to resume operation and charge the battery supply.

1.1.11 Workplace Ergonomics

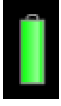
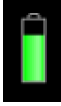
The A5/A3 is a full-featured anesthesia delivery work station. The raised perimeter of its stainless steel work surface retains items that might otherwise roll or slide off its edge. The work surface light has high and low brightness settings. The wrap-around handle enables fine positioning of the machine. Three (3) large drawers are available for storage. All drawers can be locked with a key. Rail mounts on both sides of the machine enable mounting of patient monitors and most standard attachment arms for other devices. For the A5, a non-slip footrest and central brake are provided. For the A3, a non-slip footrest and individual caster brakes are provided. The top shelf can be used to mount additional equipment.

The operator of the A5/A3 should be positioned in front of the monitor at a comfortable distance to view all displayed waveforms, text, and controls.

1.1.12 Hook

There is a hook located on the front of the breathing system that can be used to hang the tubes of the breathing circuit.

1.2 Physical Views

1.2.1 Main Unit (Front View)

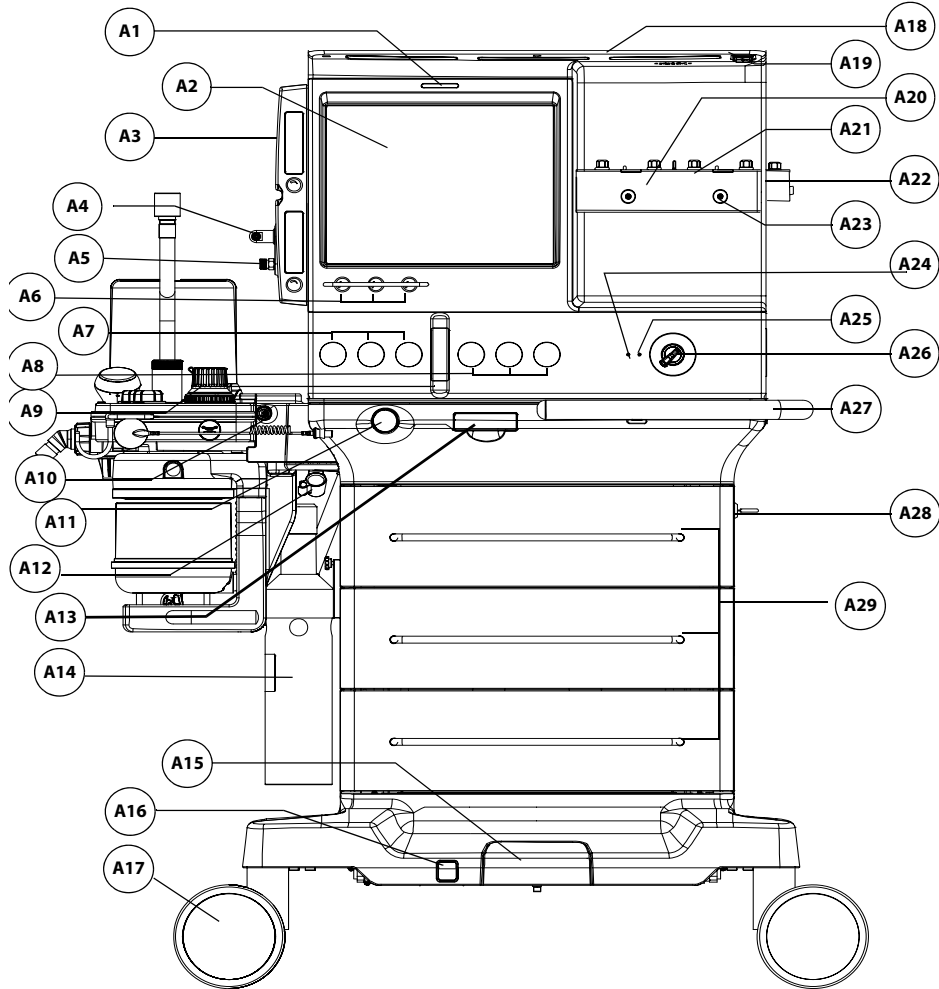

FIGURE 1-2 Main Unit (Front View)

PART(S)	DESCRIPTION
A1 Alarm Light	Illuminates red, yellow, or cyan during an alarm condition to indicate the alarm priority. Red = high priority, Yellow = medium priority, cyan = low priority, off = no alarm condition.
A2 LCD Touchscreen Display / System Interface	See section "System Interface" on page 3-1
A3 Auxiliary O₂/Air Flowmeters	Auxiliary O ₂ /Air Flowmeters for auxiliary O ₂ /Air output

PART(S)	DESCRIPTION
A4 Auxiliary O₂/Air Gas Outlet	Nozzle (barbed connector) for auxiliary O ₂ /Air output. Combines the auxiliary O ₂ /Air flowmeters into a single output of O ₂ only, Air only, or O ₂ /Air blend, depending upon the O ₂ and Air flow adjustments.
A5 Auxiliary O₂ Gas Power Outlet (A5 only)	High pressure O ₂ outlet (DISS connector) for connecting external devices such as a jet ventilator.
A6 Flow Control Knobs	N ₂ O, Air, and O ₂ gas dosing. Turn each knob counterclockwise to increase flow.
A7 Pressure Gauges (pipeline)	Indicate the pressure at pipeline inlets for O ₂ , Air, and N ₂ O.
A8 Pressure Gauges (cylinder)	Indicate the pressure at cylinder inlets for O ₂ , Air, and N ₂ O.
A9 Total Flow Meter	Displays the combined flow rate of O ₂ , Air, and N ₂ O.
A10 O₂ Sensor Electrical Port	Connects the O ₂ sensor cable on the breathing system to the main A5/A3 unit.
A11 O₂ Flush Button	Provides high flow O ₂ to the inspiratory limb of the breathing system.
A12 Vacuum suction fixing clip	Holds the tubes of the negative pressure suction device.
A13 Touchpad (A5 only)	Allows alternative control of the touch screen. Pull out to use.
A14 AGSS	Anesthetic Gas Scavenging System
A15 Wheel Lock (A5 only)	Locks or releases the brakes for all wheels when depressed.
A16 Wheel Lock Indicator (A5 only)	Displays a lock symbol in red background to indicate the wheels are locked, or an unlock symbol in green background to indicate the wheels are unlocked.
A17 Wheels	Casters to enable the A5/A3 System to be moved. Casters on the A5 lock via a central brake. Casters on the A3 lock via individual locking levers on each caster.
A18 Work Light	Located under the top shelf to illuminate the work level shelf and allow the user to read the vaporizer dial setting in a dim light room.
A19 Work Light Switch	Turns on/off the work light. Three settings: Off, Low, and High. The user can turn on the work light only when the system switch is turned on.
A20 Vaporizer Mounting Manifold / Mounting Bar	An interface for two/three Selectatec-type vaporizers to mount in this location. Bar holds two/three (optional) vaporizers. An interlock within the vaporizers provides for use of one vaporizer to deliver one agent at a time.
A21 Vaporizer Mount Valve Cartridge	Vaporizer index and outlet ports.
A22 Vaporizer Parking Spot	Holds a non-functional vaporizer for user convenience. (A5 standard, A3 optional)
A23 Vaporizer Locking Device	Vaporizer locking mechanism to secure against accidental disconnection
A24 AC Status LED	Illuminated when the system is connected to an AC power source.
A25 Battery Charging LED	Illuminated when the battery supply is charging.
A26 System Switch	Switch to turn the system on or off.
A27 Handle	Metal bar used to assist moving the A5/A3

PART(S)	DESCRIPTION
A28 Key lock	Key and lock for securing the drawers
A29 Storage Drawers	Drawers (3) for storage (lockable)

1.2.2 Main Unit (Rear View)

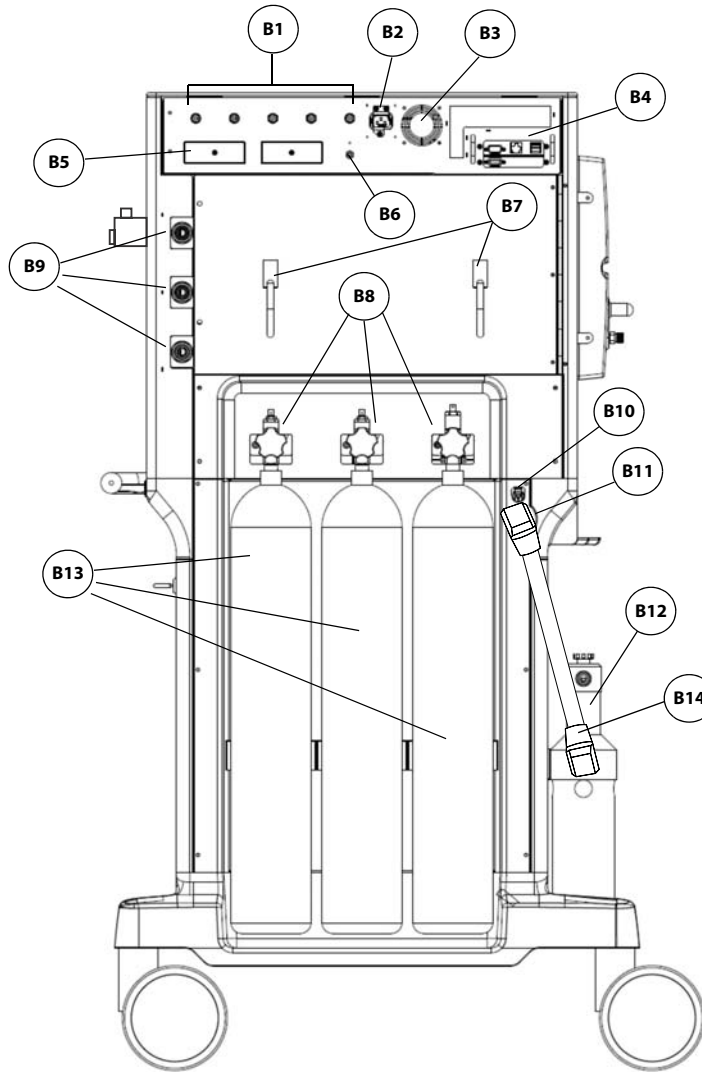

FIGURE 1-3 Main Unit (Rear View)

PART(S)	DESCRIPTION
B1 Circuit Breakers	Breakers for each auxiliary outlet A5: 3 A each (quantity 4), 10 A total (quantity 1) A3: 3 A each (quantity 3)
B2 Mains Inlet	Connects the mains power cord

PART(S)	DESCRIPTION
B3 Exhaust Fan	Forces air to cool electronics and prevent buildup of O ₂ concentration. Do not block.
B4 Communication Ports	SP1, DP1, CS1, SB1, SB2 (see section 9.6.4 (page 9-8) "Communication Ports"). CAUTION: Do not connect any devices to the SB ports other than Mindray approved USB storage devices and a supported USB mouse (see "Networking and USB Storage" on page A-4).
B5 Auxiliary AC Outlets	A5: Additional devices up to a total maximum power of 10 amps can be connected to four (4) outlets. A3: Additional devices up to a total maximum power of 9 amps can be connected to three (3) outlets. The A5 outlets are covered with two (2) metal plates, the A3 outlets are covered with one (1) metal plate, and require a tool to access. Only authorized personnel can access these outlets.
B6 Equipotential stud / lug	Provides a ground point. Eliminates the ground potential difference between different devices to ensure safety.
B7 Hooks	Allows user to hang or wrap cords
B8 Cylinder Supply Connections	Interface connectors to high pressure supply tanks (O ₂ , Air, and N ₂ O)
B9 Gas Pipeline Supply Connections	Connections for O ₂ , Air, and N ₂ O from a pipeline gas supply
B10 Sample Line Exhaust Gas Inlet	Inlet for exhaust gas from gas module. Merges with the AGSS connector that connects to the AGSS.
B11 AGSS Connector	Connects the AGSS or waste gas disposal system
B12 AGSS	Anesthetic Gas Scavenging System
B13 Cylinders	Supply tanks (E-size) containing high pressure O ₂ , Air, and N ₂ O to act as backup supply if the pipeline pressure is removed. Note: Tanks not supplied by Mindray.
B14 AGSS Transfer Hose	Routes exhaust gases from main unit to scavenger.

1.2.3 Main Unit (Left View)

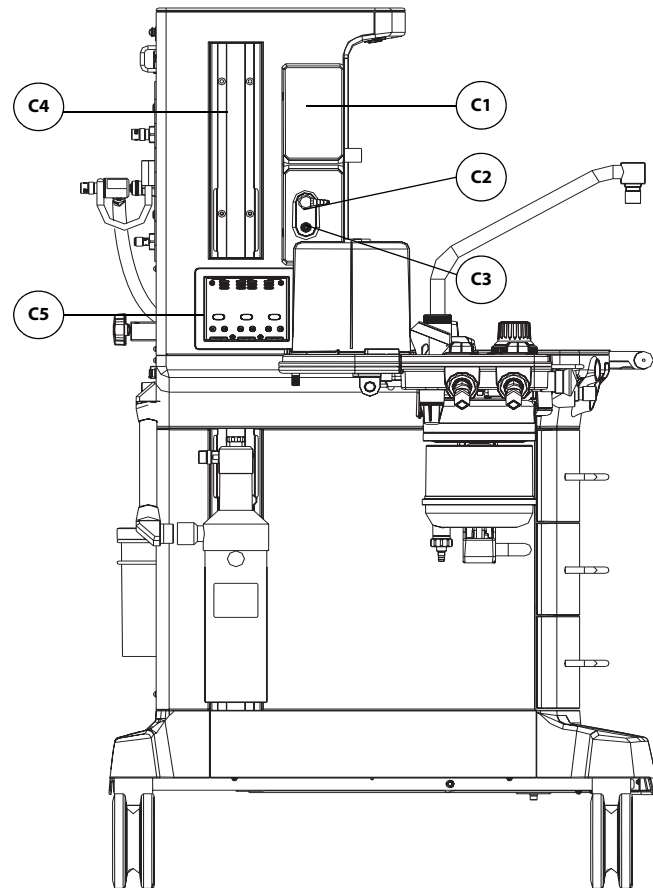
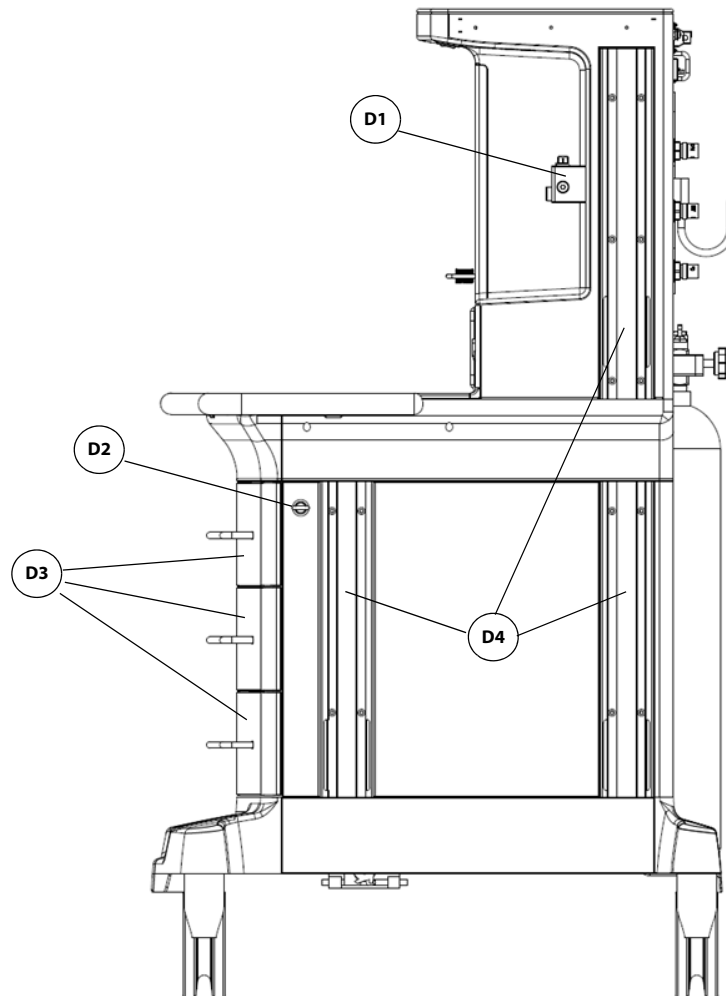

FIGURE 1-4 Main Unit (Left View)

PART(S)	DESCRIPTION
C1 Auxiliary O₂/Air Flowmeters	Auxiliary O ₂ /Air Flowmeters for auxiliary O ₂ /Air output
C2 Auxiliary O₂/Air Gas Outlet	Nozzle (barbed connector) for auxiliary O ₂ /Air output. Combines the auxiliary O ₂ /Air flowmeters into a single output.
C3 Auxiliary O₂ Gas Power Outlet (A5 only)	High pressure O ₂ outlet (DISS connector) for connecting external devices such as a jet ventilator.
C4 Rail Mount	Enables mounting of patient monitors and most standard attachment arms for other devices. Rail mounts are on both left and right sides of the A5/A3.
C5 Module slot	AG module can be inserted into the slot and identified.

1.2.4 Main Unit (Right View)

**FIGURE 1-5** Main Unit (Right View)

PART(S)	DESCRIPTION
D1 Vaporizer Mounting Manifold / Mounting Bar	An interface for two/three Selectatec-type vaporizers to mount in this location. Bar holds two/three (optional) vaporizers. An interlock within the vaporizers provides for use of one vaporizer to deliver one agent at a time.
D2 Key Lock	Key and lock for securing the drawers
D3 Storage Drawers	Drawers (3) for storage (lockable)
D4 Rail Mount	Enables mounting of patient monitors and most standard attachment arms for other devices. Rail mounts are on both left and right sides of the A5/A3.

1.2.5 Main Unit (Top View)

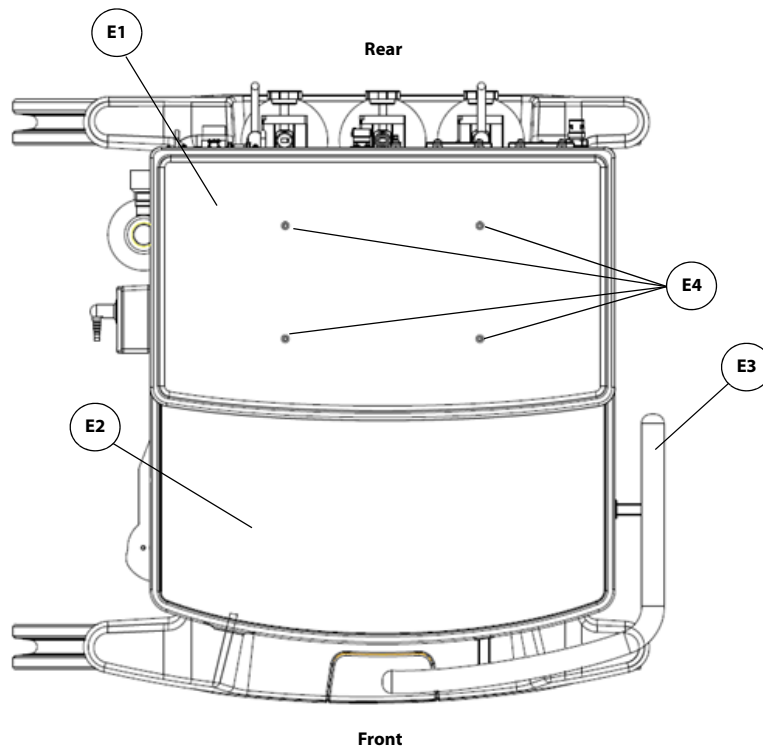

FIGURE 1-6 Main Unit (Top View)

PART(S)	DESCRIPTION
E1 Top Shelf	Top level surface
E2 Work Level Shelf	Work Level surface (stainless steel)
E3 Handle	Wrap-around metal bar used to assist moving the A5/A3 device
E4 Mounting Holes	Allows mounting of optional equipment to the top shelf (i.e., DPM6 and DPM7 mounting plates and kits (see section A.7 (page A-3) "Mounting Accessories").

1.2.6 Breathing System (Top View)

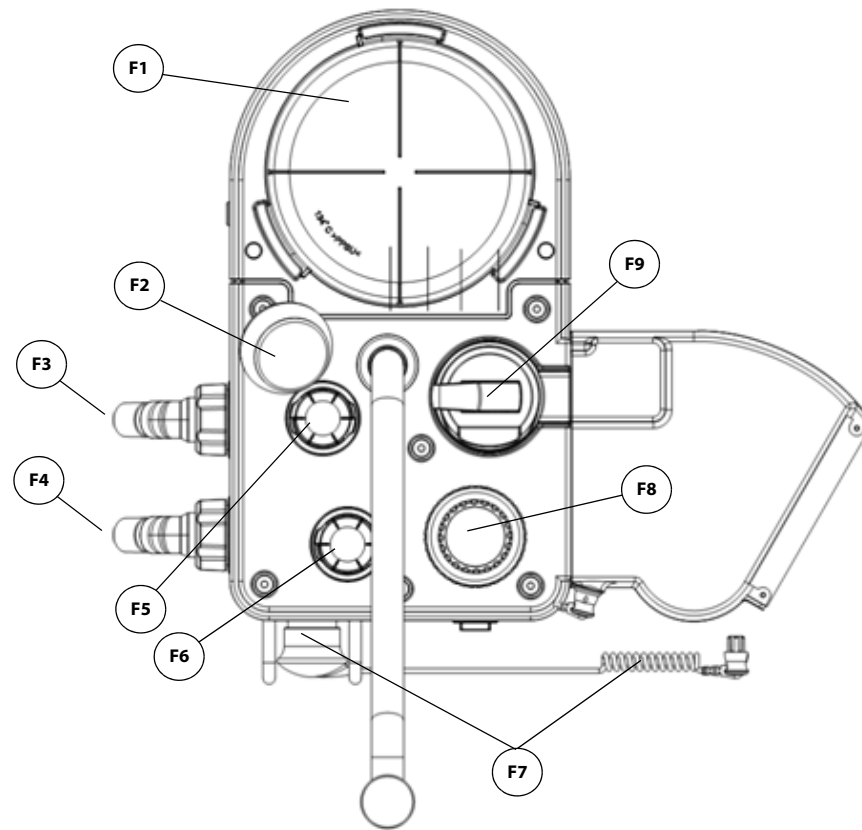

FIGURE 1-7 Breathing System (Top View)

PART(S)	DESCRIPTION
F1 Bellows (including bellows dome)¹	Bellows that separates the breathing system gases from the oxygen drive gas
F2 PAW Gauge²	Indicates the patient airway pressure
F3 Expiratory Limb	Exhaled breathing circuit connection
F4 Inspiratory Limb	Inhaled breathing circuit connection
F5 Expiration Valve	Allows flow of expiratory gas from the patient to the re-breathing system, and prevents reverse flow.
F6 Inspiration Valve	Allows flow of inspiratory gas to the patient, and prevents reverse flow.
F7 O₂ Sensor Cable Assembly	An electro-galvanic fuel cell device to measure the concentration of O ₂ . The assembly is composed of the O ₂ cable, O ₂ cell cover, and O ₂ sensor.

¹ The bellows dome is a transparent cover with graduation marks from 300 to 1500 ml. These marks are for reference only. Tidal volume (V_t) should be read exclusively from the display of the user interface. Delivered V_t is a combination of bellows displacement and fresh gas flow.

² The APL valve and PAW gauge numerics are for reference only. Calibrated patient airway pressure is displayed on the user interface.

PART(S)	DESCRIPTION
F8 APL (Airway Pressure Limiting) Valve²	Rotary regulator for setting the breathing system pressure limit during manual ventilation. Its scale shows approximate pressure. Set to SP during Spontaneous breathing.
F9 Auto/Manual Bag Switch	Enables switching between Automatic and Manual ventilation modes

¹ The bellows dome is a transparent cover with graduation marks from 300 to 1500 ml. These marks are for reference only. Tidal volume (Vt) should be read exclusively from the display of the user interface. Delivered Vt is a combination of bellows displacement and fresh gas flow.

² The APL valve and PAW gauge numerics are for reference only. Calibrated patient airway pressure is displayed on the user interface.

1.2.7 Breathing System (Left View)

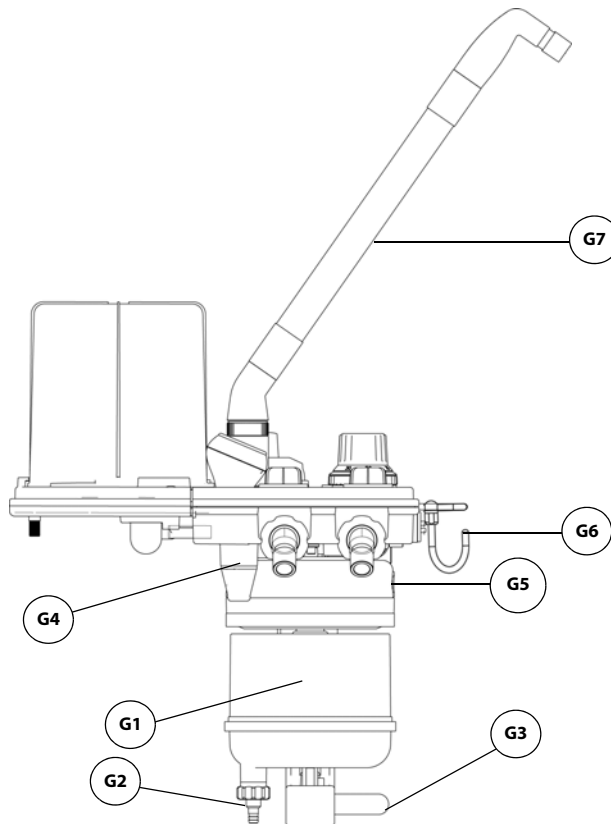

FIGURE 1-8 Breathing System (Left View, the Flexible Bag Arm (optional))

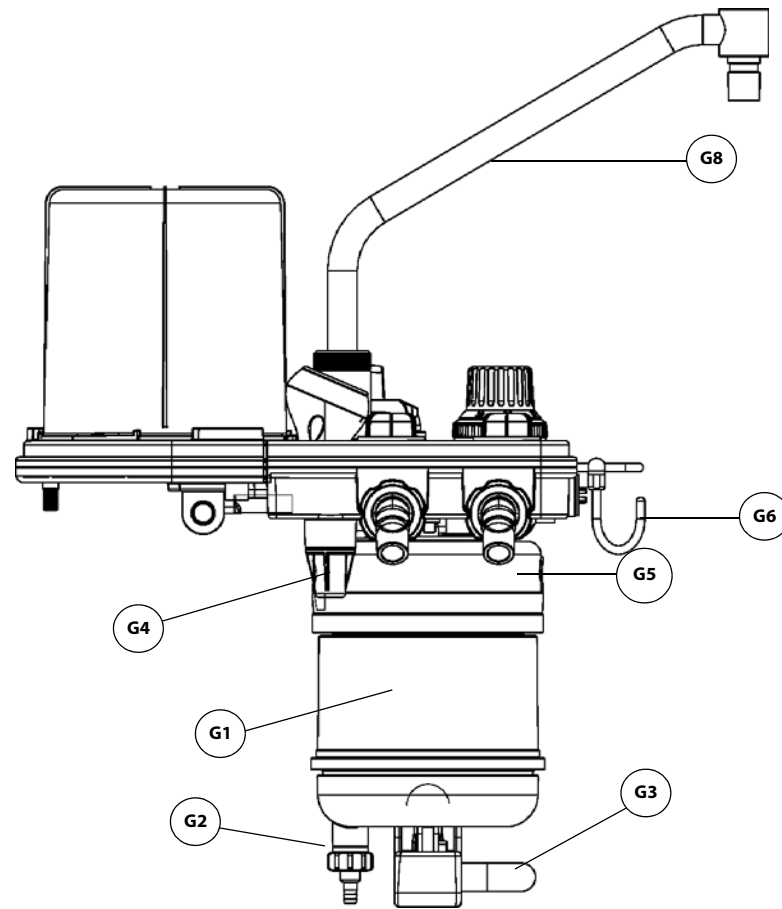

FIGURE 1-9 Breathing System (Left View, the Fixed Height Bag Arm (standard))

PART(S)	DESCRIPTION
G1 CO₂ Absorber Canister	Container for CO ₂ absorbent material loose fill or Pre-Paks)
G2 Condensate Drain Valve	Turn counter-clockwise (looking from bottom) to drain water collected in the absorber canister.
G3 Absorber Canister Lock	Lever-type locking mechanism to lock (horizontal position) or unlock (vertical position) the absorber canister from the canister assembly.
G4 Water Trap	Accumulates condensate from the breathing system. Must be removed and emptied periodically. To remove, turn clockwise (looking from top).
G5 Absorber Bypass Assembly	Maintains pressure in the breathing circuit when changing the soda lime contents in the CO ₂ absorber canister.
G6 Hook	Hang the tubes of the breathing system.

PART(S)	DESCRIPTION
G7 Flexible Bag Arm	Provides the interface with the manual ventilation bag. The flexible bag arm can be adjusted to desired height and the bag port can be rotated 360°.
G8 Fixed Height Bag Arm	Provides the interface for the manual ventilation bag. The height of fixed bag arm cannot be adjusted and the bag port is in a fixed direction.

1.2.8 Active Anesthetic Gas Scavenging System (AGSS) (Top, Right, and Rear Views)

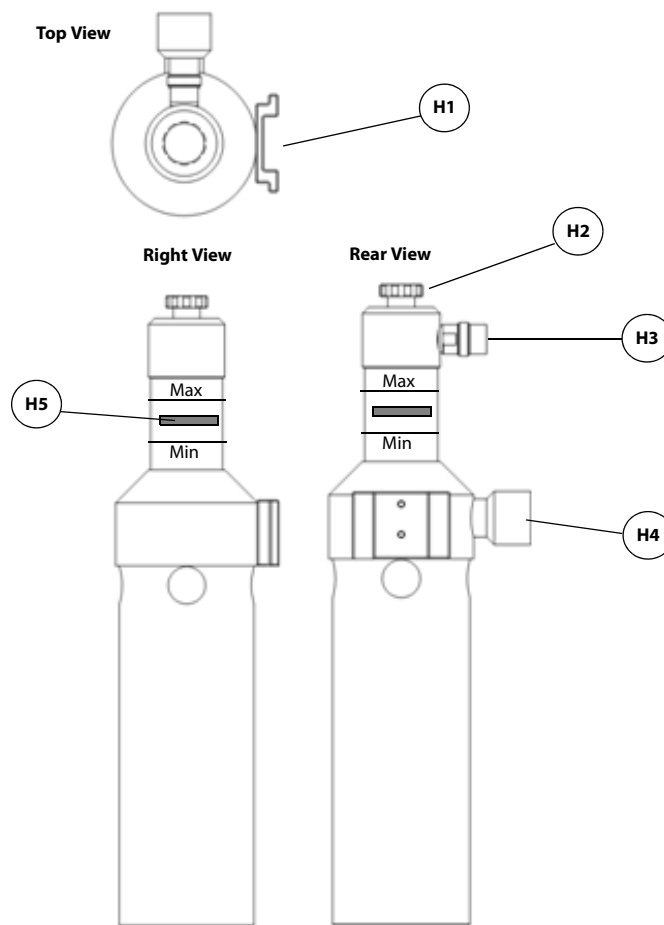

FIGURE 1-10 Active AGSS (Top, Right, and Rear Views)

PART(S)		DESCRIPTION
H1	Mounting Rail Attachment	Allows the AGSS to be mounted on the side rail. Contains a thumbscrew that must be tightened against the mounting rail.
H2	Flow Adjust Knob	Turn clockwise or counter-clockwise to adjust the flow in the AGSS until the float is between Min and Max marks.
H3	Exhaust Port	Exhaust port to the hospital's waste gas scavenging system
H4	Inlet Port	Intake for exhaust gases from the breathing system. An AGSS transfer hose connects the Inlet and AGSS ports (see FIGURE 1-3) to transfer the exhaust gases.
H5	Float	Indicates exhaust flow. Adjusted by turning the Flow Adjust Knob (H2) until the float is between the Min and Max marks.

1.2.9 Passive Anesthetic Gas Scavenging System (AGSS) (Right View)

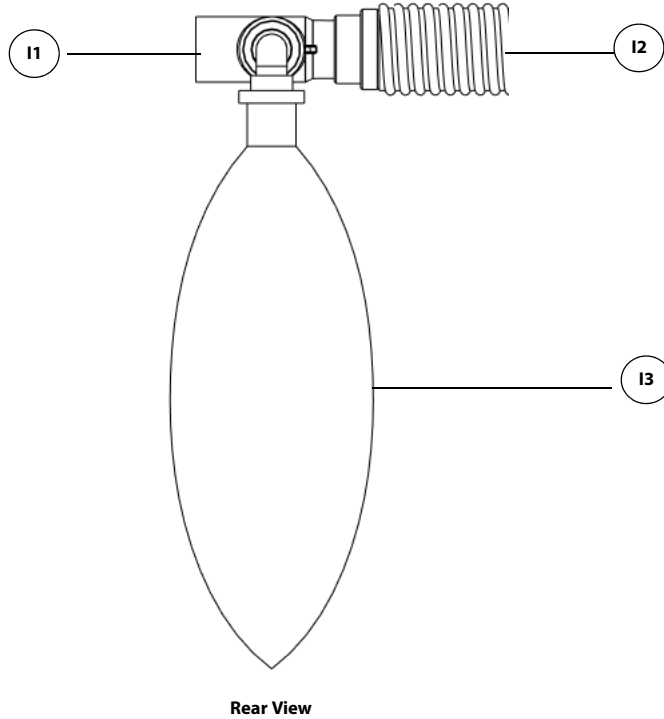

FIGURE 1-11 Passive AGSS (Right View)

PART(S)	DESCRIPTION
11 Inlet Port	Intake for exhaust gases from the breathing system connecting with the AGSS ports.
12 Exhaust Port	Exhaust port to the hospital's waste gas scavenging system.
13 Manual Bag	When the manual bag is inflated, it indicates that the passive AGSS is blocked.

This page intentionally left blank.

2.0

Installation

Unpacking.....	2-3
Initial Setup.....	2-4
Install the Vaporizer.....	2-5

- WARNING:** This equipment must be installed by a factory authorized representative.
- WARNING:** Continuous use of desiccated soda lime may endanger patient safety. Adequate precautions should be taken to ensure that the soda lime in the CO₂ absorbent canister does not become desiccated. Turn off all gases when finished using the system.
- WARNING:** When electrosurgical equipment is used, keep the electrosurgical leads away from the breathing system, the O₂ sensor, and other parts of the A5/A3 Anesthesia System. Keep available backup manual ventilation and a respirator with mask in case the electrosurgical equipment prevents safe use of the ventilator. Ensure the correct operations of all life support and monitoring equipment.
- WARNING:** Do not use masks or breathing tubes that are antistatic or conductive. They can cause burns if they are used near high frequency electrosurgical equipment.
- WARNING:** This A5/A3 Anesthesia System has waste gas exhaust ports. The operator of the machine should pay attention to the disposal of the residual breathing gas scavenged.
- CAUTION:** The operational environment and the power source of the equipment must comply with the requirements as specified in the A5/A3 "Product Specifications" on page 9-1 .

2.1 Unpacking

When the A5/A3 Anesthesia System is delivered, IMMEDIATELY inspect the box for any damage.

- a.** If there is NO damage and ALL tip indicators on the box exterior are intact, then sign and date the bill of lading or airway bill to indicate safe receipt of the A5/A3.
- b.** If there is DAMAGE or ANY of the tip indicators on the box exterior have been activated, then conditionally accept the delivery and clearly describe the damages on the bill of lading or airway bill. BOTH the carrier and recipient must sign and date the bill of lading or airway bill. Save all damaged factory packaging until further instructed by Mindray. The receiver should immediately contact Mindray Customer Service at (800) 288-2121 or (201) 995-8000.

2.2 Initial Setup

The initial setup of the A5/A3 Anesthesia System must be performed by an authorized Mindray service representative. Please contact Mindray Technical Support for any additional assistance.

NOTE: **The A5/A3 is intended to be operated with an external CO2 monitor complying with ISO 80601-2-55. Connection to the CO2 monitor should be via a sample line from the patient circuit.**

2.3 Install the Vaporizer

CAUTION: Only vaporizers with Selectatec Interlock Systems may be used with the A5/A3 unit.

WARNING: Use vaporizers compliant to ISO 80601-2-13. See section A.9 (page A-5) "Vaporizers". Refer to the vaporizer manufacturer's Instructions For Use for mounting, filling, or draining the vaporizer and other information.

WARNING: Use care in lifting and manipulating vaporizers during the mounting process as their weight may be greater than expected, based on their size and shape.

NOTE: The barometric pressure may differ from the calibration pressure of the anesthetic vaporizer. This may cause an inaccurate output of the anesthetic agent. The operator should continuously monitor the concentration of anesthetic agent during system use to determine if the output concentration is accurate.

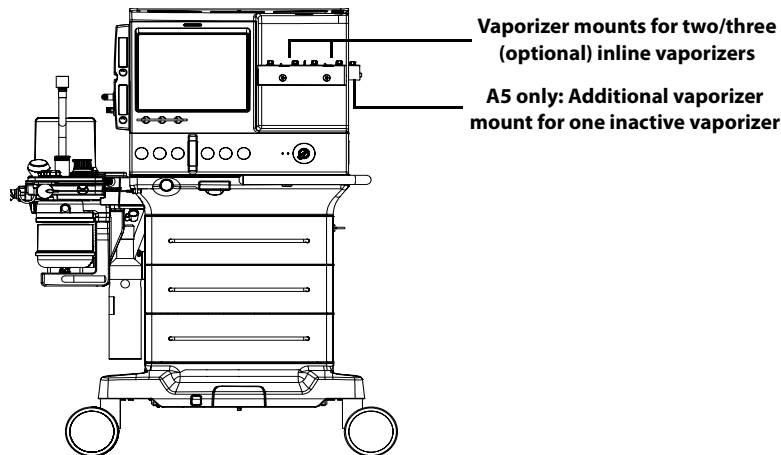

FIGURE 2-1 Location of Vaporizer Mounting System

1. If replacing and removing the vaporizer, lift each vaporizer straight up off the manifold. Do not pull the vaporizer forward. Do not rotate the vaporizer on the manifold.
2. Align the new vaporizer over the valve cartridges of the mounting bar, slightly tilting back the vaporizer. Hang the vaporizer on the mounting bar (see FIGURE 2-2). Ensure that the locking mechanism handle is in the unlocked position. Ensure that the dial is in the "0" (Transport) position or equivalent, depending upon the vaporizer manufacturer's Instructions For Use.

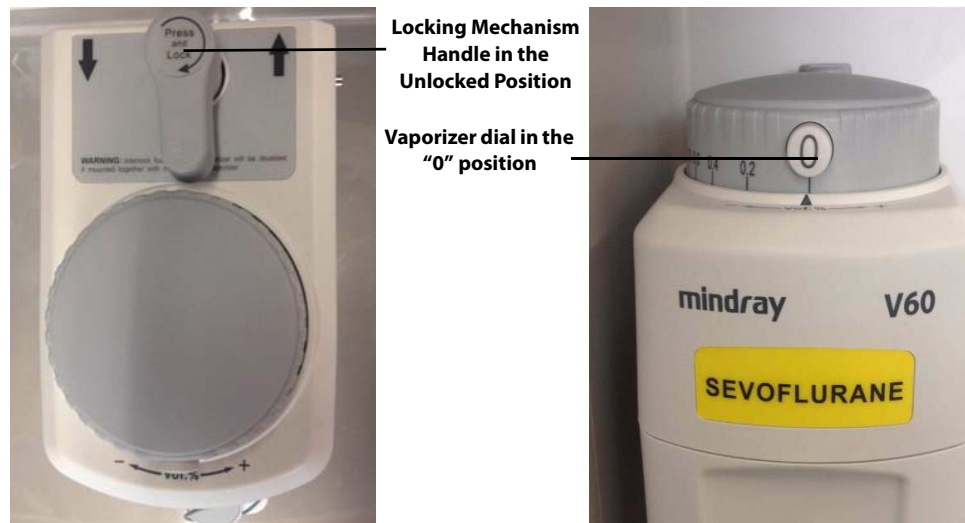

FIGURE 2-2 Vaporizer, Unlocked

3. Rotate the locking mechanism handle clockwise into the locked position (see FIGURE 2-3).

NOTE: If installing a Desflurane vaporizer, refer to the manufacturer's Instructions For Use on installation and use of the vaporizer.

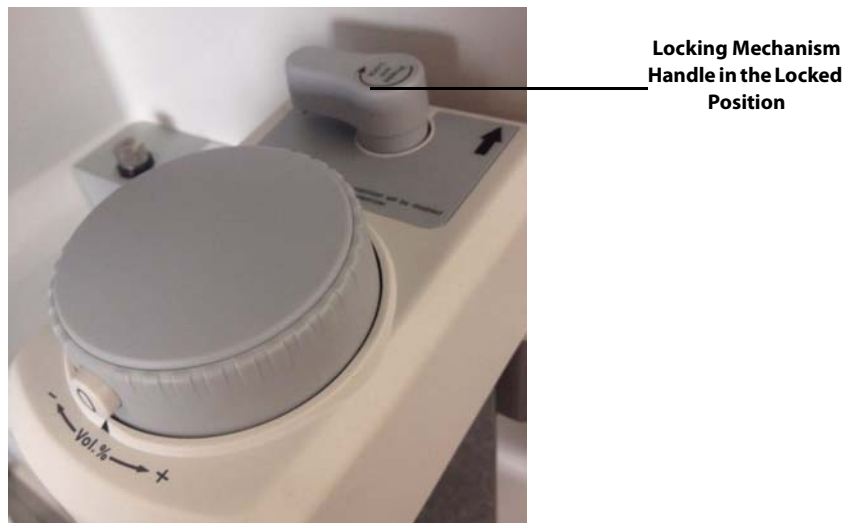

FIGURE 2-3 Vaporizer, Locked

4. Final check:
 - a. Ensure that the top of the vaporizer is horizontal. If not, remove and reinstall the vaporizer.
 - b. If a vaporizer lifts off the manifold, repeat steps 1 through 3 to reinstall the vaporizer. If the vaporizer lifts off a second time, do not use the system.

WARNING: For the A5/A3 Anesthesia System, using or turning on more than one vaporizer simultaneously is prohibited and prevented by a mechanical interlock. Do not attempt to override this safety mechanism.

2.3.1 Filling and Draining the Vaporizer

Install the vaporizers with a Selectatec interlock system that are compliant to ISO 80601-2-13 on the A5 unit. See section A.9 (page A-5) "Vaporizers". Refer to the vaporizer manufacturer's Instructions For Use for filling or draining the vaporizer and other information.

WARNING: Ensure that the correct anesthetic agent is used. The vaporizer is designed with the specific anesthetic agent named on it and further indicated by color coded labelling. The concentration of the anesthetic agent actually output will vary if the vaporizer is filled with the wrong agent.

WARNING: Do not reuse the agent drained from the vaporizer. Treat as a hazardous chemical and follow local regulations for proper disposal.

This page intentionally left blank.

System Interface

Main Screen Components	3-2
System Information Header	3-6
Fresh Gas Flow Display	3-11
Waveforms Tab	3-12
Spirometry Tab (A5 Only)	3-14
Demographics Tab	3-20
Ventilation Mode Tabs	3-21
Measured Values Area	3-24
System Softkeys	3-25
Setup	3-32
General Tab	3-32
Display Tab	3-34
System Tab	3-38
Service Tab	3-44

3.1 Main Screen Components

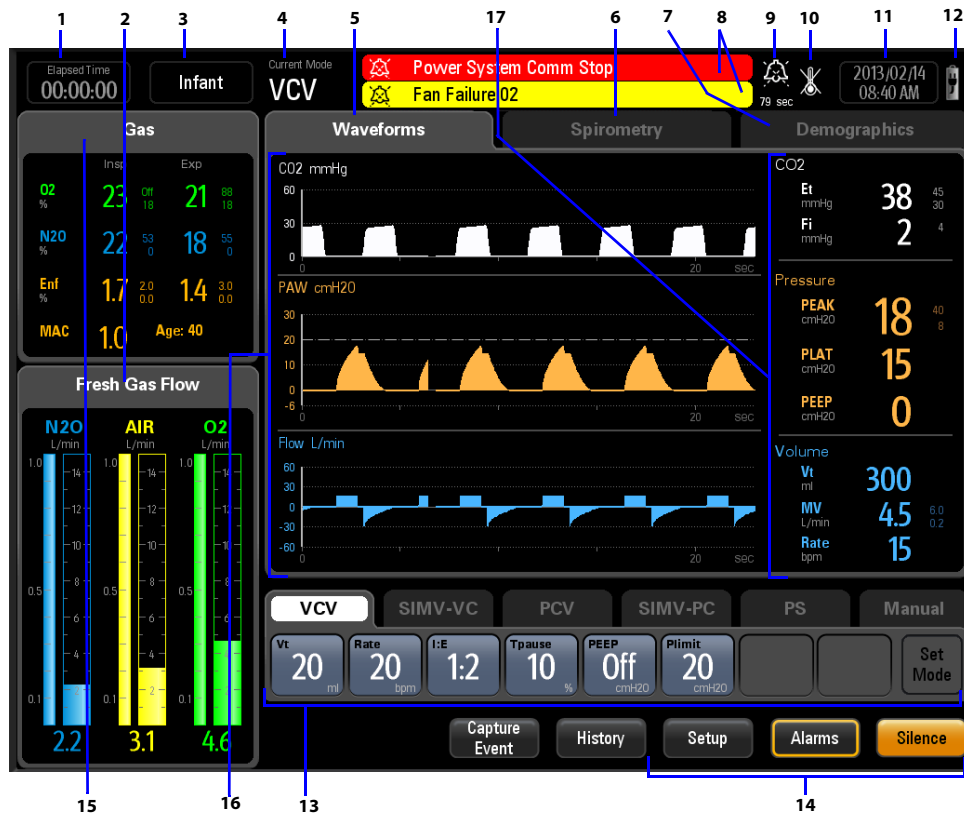

FIGURE 3-1 A5 Main Screen Components

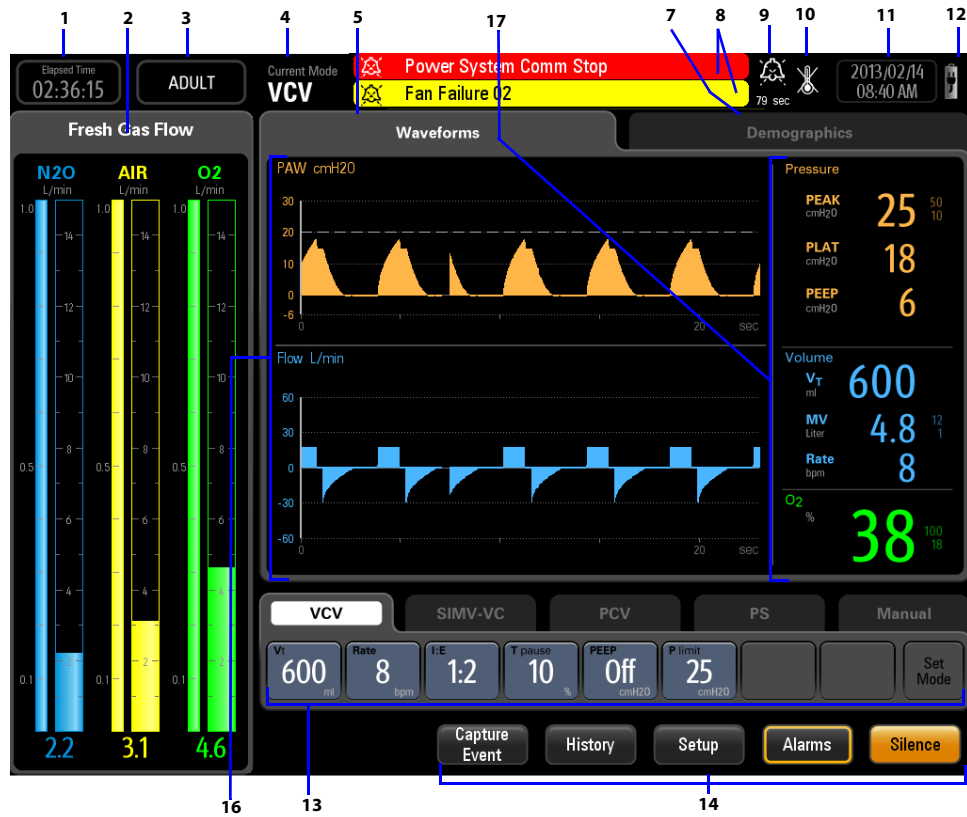

FIGURE 3-2 A3 Main Screen Components (without AG gas module connected)

NUMBER	MAIN SCREEN COMPONENT	DESCRIPTION
1	Elapsed / Countdown Timer	Displays elapsed time or countdown time. Select to start, stop, or reset the timer.
2	Fresh Gas Flow Area	Displays real-time flowmeter levels for N ₂ O, Air, and O ₂ .
3	Patient Size	Displays the currently selected patient size (Adult, Pediatric, or Infant). Select to change the patient size when the A5/A3 is in Standby mode, Manual mode or Monitor* mode
4	Current Ventilation Mode	Displays the current ventilation mode (VCV, SIMV-VC, PCV, SIMV-PC*, PS, Manual, Bypass**, Monitor or Standby.)
5	Waveforms Tab	See "Waveforms Tab" on page 3-12.
6	Spirometry Tab	A5 only. See "Spirometry Tab (A5 Only)" on page 3-14.
7	Demographics Tab	See "Demographics Tab" on page 3-20.

* Monitor mode is only available with the AG module.

**SIMV-PC and Bypass are only available on A5.

NUMBER	MAIN SCREEN COMPONENT	DESCRIPTION
8	Alarm / Prompt Message Area	<p>Displays physiological alarms, technical alarms, and prompt messages. The most recent highest priority alarm is displayed at the top.</p> <p>The remaining alarms are displayed in the lower area and grouped by priority. The most recent of these alarms is displayed first. Select this area to display a list of all active alarms.</p> <p>See "Alarms and Messages" on page 6-1 for tables that list the individual messages and their associated priority levels. High priority messages are red. Medium priority messages are yellow. Low priority messages are cyan. Prompt messages are black text on white background.</p>
9	Alarm Silence Icon	Displays the alarm silence icon and Alarm Silence countdown timer for 120 seconds when the Silence softkey is selected.
10	Breathing System Warmer Icon	Indicates the warmer is not active.
11	System Date and Time	Displays the current system date and time. Select to adjust the date and time. See "Date and Time" on page 3-9.
12	Main Power Supply and Battery Status Icon	Displays the main power supply and battery state. See "Power Management / Battery Supply" on page 1-6.
13	Ventilations Mode and Setting Parameters Area	Displays tabs for all ventilation modes (VCV, SIMV-VC, PCV, SIMV-PC*, PS, Manual/Bypass* or Monitor). Each tab displays the ventilation mode and its parameters. Select a tab and the "Set Mode" softkey to change the ventilation mode. Select a parameter button to change the parameter setting. See "Ventilation Modes" on page 5-8.

* Monitor mode is only available with the AG module.

**SIMV-PC and Bypass are only available on A5.

NUMBER	MAIN SCREEN COMPONENT	DESCRIPTION
14	System Softkeys	<p>Setup – Select to open the Setup menu. The Setup menu contains the General tab, Display tab, System tab, and Service tab.</p> <p>Alarms – Select to open the Alarms menu to set alarm limits, set alarm volume, and view all active alarms.</p> <p>Silence – Select Silence softkey to silence all currently sounding alarm tones. The alarm will sound if a new alarm occurs.</p> <p>If the silenced alarms contain middle or high level alarms, the alarm audio will be paused for 120 seconds. The alarm silence icon and 120 second countdown time appear at the top of the screen. Select again to resume the alarm audio. Note, however, the alarm will sound if that a new alarm occurs while the system is in an audio-paused state. If this occurs, you can select the Silence softkey again to silence the new alarm and reset the silence countdown timer to 120 seconds.</p> <p>Found in software bundle version 02.04.00 and later</p> <p>If the silenced alarm is low level alarm, the alarm audio will be turned off till a new alarm occurs. Note, however, the alarm will sound if that a new alarm occurs while the system is in an audio-off state. If the new alarm is low level alarm, you can select the Silence softkey again to turn off the new alarm audio. If the new alarm is medium or high level alarm, you can select the Silence softkey again to silence the new alarm for 120 seconds.</p> <p>Found in software bundle version 02.02.00 and later</p> <p>History - Select to open the History menu. The History menu contains the List Trends and Event log.</p> <p>Capture Event - Select to capture an event and log it in the event log.</p>
15	Gas Area	Displayed when AG module is connected. Displays real-time inspiratory and expiratory levels of gas.
16	Waveforms/Spirometry Area	Displays waveforms or spirometry.
17	Monitored Parameter Area	Displays monitored parameters.

* Monitor mode is only available with the AG module.

**SIMV-PC and Bypass are only available on A5.

3.2 System Information Header

3.2.1 Elapsed / Countdown Timer

Displays the elapsed time, countdown time, or both. Located at the top left of the main screen. Select the timer icon to open the **timer** menu (see FIGURE 3-3).

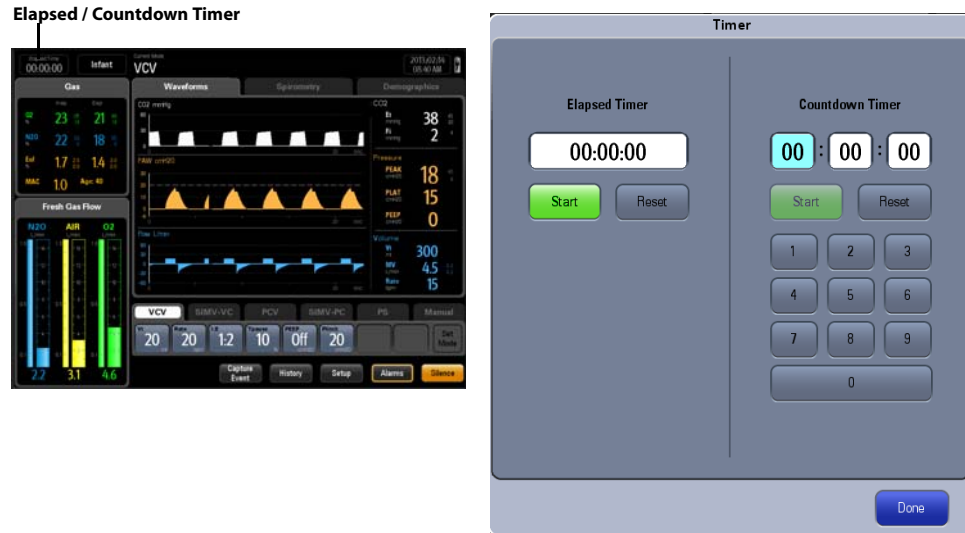

FIGURE 3-3 Elapsed / Countdown Timer

Elapsed Timer

Select the **Start** button to turn on the elapsed timer (see FIGURE 3-4). Select the **Stop** button to pause the elapsed timer and the timer will flash. Select the **Reset** button to turn off the elapsed timer.



FIGURE 3-4 Only Elapsed Timer Screen

Countdown Timer (software bundle version 02.06.00 and later)

Input the time with the keypad and select the **Start** button to turn on the countdown timer (see FIGURE 3-5). Select the **Stop** button to pause the countdown timer and the timer will flash. Select the **Reset** button to turn off the countdown timer.

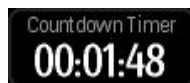

FIGURE 3-5 Only Countdown Timer Screen

When the countdown timer is expired, the system will pop-up a warning dialog (see FIGURE 3-6) and provide a notification sound at the same time. The sound will repeat until the **Done** button is pressed.



FIGURE 3-6 Countdown Timer Expired

Elapsed and Countdown Timer (software bundle version 02.06.00 and later)

Turn on both the elapsed and countdown timer, the figure below displays on the screen (see FIGURE 3-7).

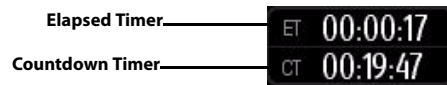

FIGURE 3-7 Elapsed and Countdown Timer Screen

3.2.2 Patient Size

Displays the currently selected patient size (Adult, Pediatric, or Infant). Select to change the patient size when the A5/A3 is in **Standby** mode, **Manual** mode or Monitor mode (available with the AG module). (FIGURE 3-8)

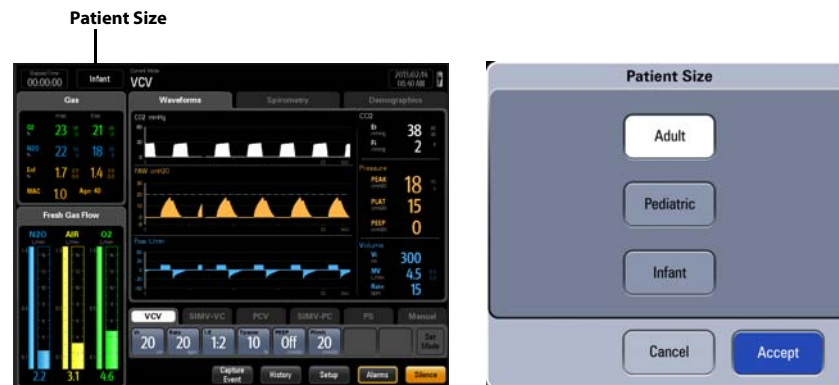

FIGURE 3-8 Patient Size Menu (with AG module connected)

3.2.3 Alarm and Prompt Messages

Displays physiological alarms, technical alarms, and prompt messages. The most recent highest priority alarm is displayed at the top.

The remaining alarms are displayed in the lower area and grouped by priority. The most recent of these alarms are displayed first.

Select this area to display a list of all active alarms. See "Alarms and Messages" on page 6-1 for tables that list the individual messages and their associated priority levels. High priority messages are red. Medium priority messages are yellow. Low priority messages are cyan. Prompt messages are black text on white background (see FIGURE 3-9).



FIGURE 3-9 Alarm and Prompt Messages

3.2.4 Alarm Silence Icon

The Alarm Silence icon and Alarm Silence countdown timer are displayed after selecting the **Silence** softkey is selected, which indicates that all currently sounding alarms are silenced for 120 seconds (see FIGURE 3-10).

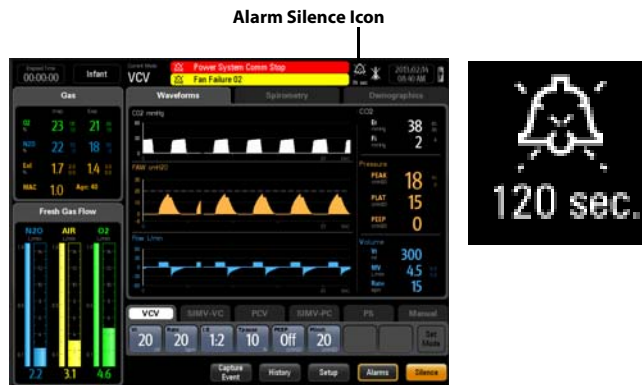

FIGURE 3-10 Alarm Silence Icon (with AG module connected)

3.2.5 Date and Time

Displays the current system date and time (see FIGURE 3-11).



FIGURE 3-11 Date and Time Icon (with AG module connected)

To adjust the date and time:

1. Select the Date and Time icon. The Date/Time dialog is displayed (see FIGURE 3-12).
2. Use the dialog keypad and softkeys to adjust the date, time, 12/24 hour format, date format, and daylight savings time.

NOTE: If applicable, select Daylight Savings Time first before all other settings.

NOTE: If the Daylight Savings Time On/Off button in the Date/Time dialog (see FIGURE 3-12) is disabled and cannot be selected, it is because the Daylight Savings setting has been set to Auto in the System settings (see TABLE 3-10, "System Tab Settings," on page 39).

3. Select the "Accept" to finalize your changes.



FIGURE 3-12 Date and Time Menu

3.2.6 Battery Status

Displays the main power supply and battery state (see FIGURE 3-14). For more information on the advanced A5/A3 power management system, see “Power Management / Battery Supply” on page 1-6.

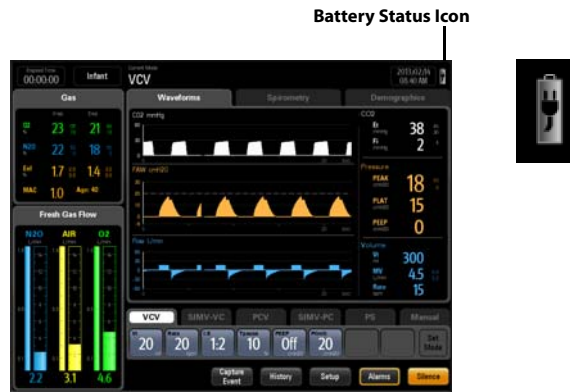

FIGURE 3-13 Battery Status Icon (with AG module connected)

PART(S)	DESCRIPTION
	Battery supply is fully charged. AC power is connected. The A5/A3 is being powered by AC power.
	Battery supply is partially charged. AC power is connected and charging batteries. The A5/A3 is being powered by AC power. The solid portion represents the current charge level of the batteries in proportion to its maximum charge level.
	Battery supply is fully charged. AC power is not connected. The A5/A3 is being powered by internal batteries.
	Battery supply is partially charged. AC power is not connected. The A5/A3 is being powered by internal batteries.
	Battery supply is low charged. Batteries need to be charged immediately to operate as a safe power backup. AC power is not connected. The A5/A3 is being powered by internal batteries.
	Battery supply is not installed.

FIGURE 3-14 Battery Status

3.3 Fresh Gas Flow Display

Displays real-time flowmeter levels for N₂O, Air, and O₂ (see FIGURE 3-15).

The flowmeter numerics display a precision to two decimal digits for flows < 1 L/min and one decimal digit for flows ≥ 1 L/min.

For the A5, the size (height) of the fresh gas flow tubes changes depending on whether the AG module is connected as shown in FIGURE 3-15.

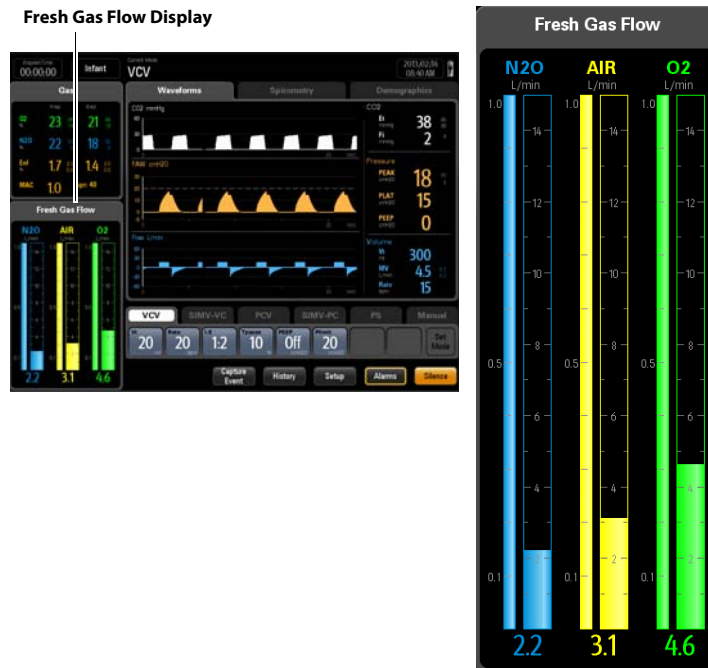

FIGURE 3-15 Fresh Gas Flow Display

3.4 Waveforms Tab

Displays PAW, Flow, Volume, CO₂, O₂, N₂O and AA (AA stands for anesthetic agent) waveforms (see FIGURE 3-16).

NOTE: O₂, N₂O and AA waveforms are available in software bundle version 02.06.00 and later.



FIGURE 3-16 Main Screen Waveforms Tab (with AG module connected)

3.4.1 Waveforms Autoscaling

If the measured value of Paw or Flow is larger than the boundary at the end of breath cycle, the system will auto scale the Paw or Flow at the beginning of the next breath cycle.

If the measured value of Paw or Flow is less than the boundary minus a margin at the end of two continuous breath cycles, the A5/A3 System will auto scale the Paw or Flow at the beginning of the next breath cycle.

Paw scale:

The margin will be 10 cmH₂O. For software bundle version 02.02.00 and later, the margin will be 10 cmH₂O if pressure \geq 30 cmH₂O.

For software bundle version 02.02.00 and later, the margin will be 3 cmH₂O if pressure $<$ 30 cmH₂O.

Flow scale:

- The margin will be 10 L/min if Flow \leq 30 L/min
- The margin will be 15 L/min if Flow $>$ 30 L/min

Volume scale:

- The margin will be 25 ml if volume \leq 100 mL
- The margin will be 100 ml if volume $>$ 100 mL

3.4.2 Waveforms Manual Scaling

The scale of CO₂, O₂, N₂O, and AA (AA stands for anesthetic agent) waveforms can be set manually through the menu:

1. Select **Setup** softkey $>$ **Display** tab.
2. Select the **Gas Scales** button.

GAS SCALES	UNIT OF MEASURE	SCALE		
	mmHg	0-40	0-60	0-80
CO₂ Scale	kPa	0.0-5.0	0.0-8.0	0.0-10.0
	%	0.0-5.0	0.0-8.0	0.0-10.0
O₂ Scale	%	0-35	0-50	0-100
N₂O Scale	%	0-35	0-50	0-100
Des Scale	%	0.0-6.0	0.0-9.0	0.0-18.0
Sev Scale	%	0.0-2.0	0.0-4.0	0.0-8.0
Iso Scale	%	0.0-1.2	0.0-2.5	0.0-5.0
Hal Scale	%	0.0-1.2	0.0-2.5	0.0-5.0
Enf Scale	%	0.0-1.2	0.0-2.5	0.0-5.0

TABLE 3-1 Gas Scales

3.5 Spirometry Tab (A5 Only)

Displays separate looped graphs and waveforms (see FIGURE 3-17).

NOTE: Displaying spirometry and waveforms simultaneously is available for software bundle version 02.06.00 and later.



You can press the  button (see FIGURE 3-17) to only view the spirometry loop (see FIGURE 3-18).



FIGURE 3-17 Spirometry and Waveforms

You can press the  button (see FIGURE 3-18) to see the spirometry loop and waveforms (see FIGURE 3-17).

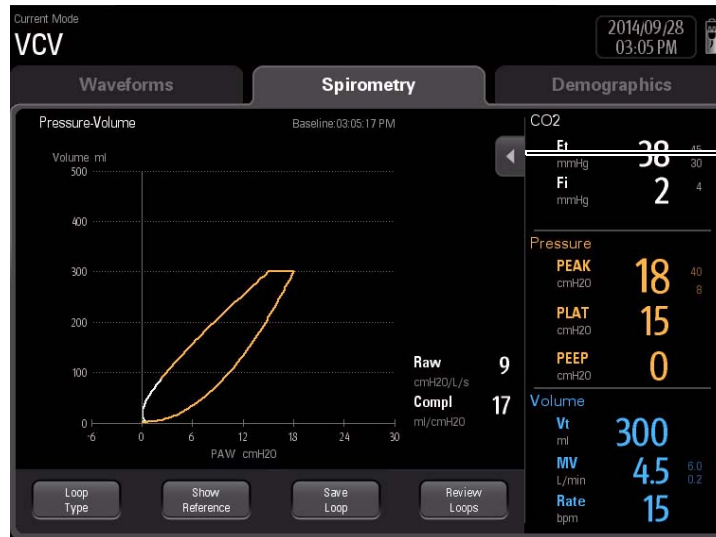

FIGURE 3-18 Spirometry: Pressure-Volume Loop

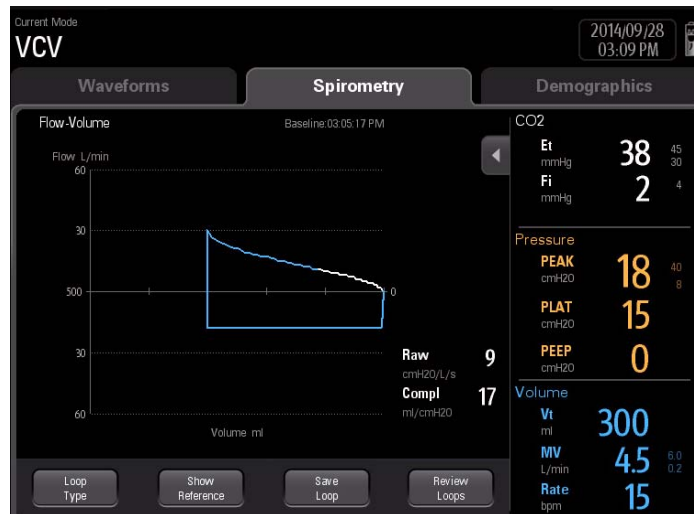

FIGURE 3-19 Spirometry: Flow-Volume Loop

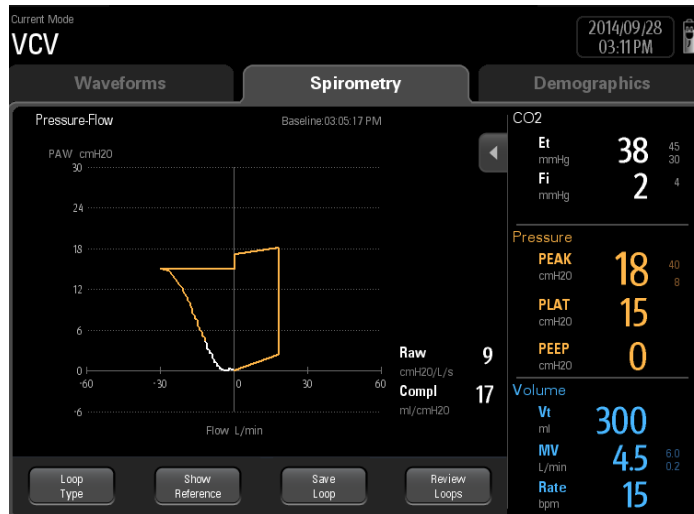

FIGURE 3-20 Spirometry: Pressure-Flow Loop (only for software bundle version 02.06.00 and later)

Spirometry loops reflect patient lung function and ventilation. They also indicate other related parameters such as compliance, over-inflation, breathing system leak, and airway blockage.

The system provides three types of spirometry loops: pressure - volume loop (see FIGURE 3-18), flow - volume loop (see FIGURE 3-19) and pressure - flow loop (see FIGURE 3-20). Loops data comes from pressure and flow data. Only one loop is displayed at a time.

The **Spirometry** tab displays four softkeys: **Loop Type**, **Show Reference**, **Save Loop**, and **Review Loops**.

3.5.1

Loop Type

The **Loop Type** selection is used to select pressure - volume loop, flow - volume loop or pressure-flow loop to display on the Spirometry screen. Default loop type is pressure - volume loop.

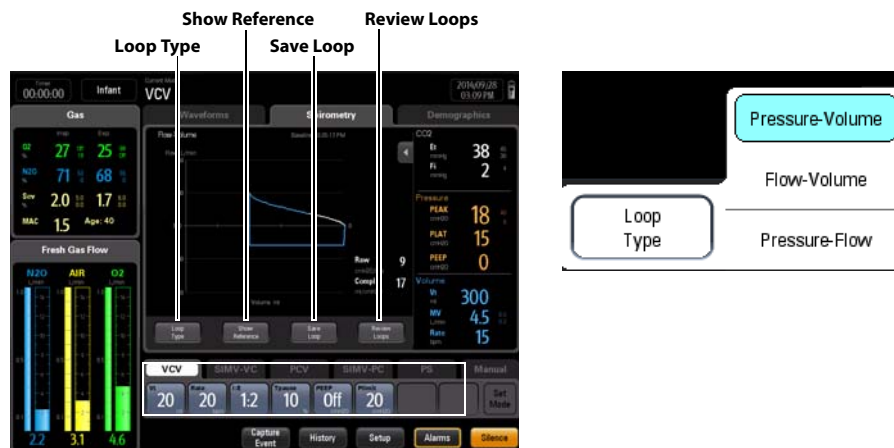

FIGURE 3-21 Spirometry Softkeys: Loop Type, Show Reference, Save Loop, and Review Loops

3.5.2 Show Reference

The **Show Reference** softkey can be selected only after a baseline has been saved via the **Save Loop** softkey.

The **Show Reference** softkey (see FIGURE 3-21) is used to select and display a saved baseline loop, reference loop, or no loop (Off) in the spirometry loop window, overlapped with the currently plotting loop. Only the four most recently saved reference loops are listed chronologically.

When a reference loop or baseline loop is selected to display in the spirometry loop Window, the time stamp will also be displayed.

3.5.3 Save Loop

Select the **Save Loop** softkey (see FIGURE 3-21) to save the currently plotting loop (including its numeric data) as either a baseline loop or reference loop. Only one baseline loop and up to four reference loops can be saved. Additional plotting loops can be saved to replace the baseline loop or reference loops. Only the four most recent reference loops are saved.

The saved baseline or reference loop can be reviewed with its numeric data (via **Review Loops** softkey) or displayed with the currently plotting loop on the same graph for comparison (via **Show Reference** softkey).

NOTE: **A reference loop cannot be saved without first saving a baseline loop. The A5 System will always make the first saved loop as the baseline loop if no previous loops have been saved. Afterward, additional loops can be saved either as a baseline replacement or as a new reference loop.**

To save a baseline loop:

1. From the main screen, select **Spirometry** tab > **Save Loop** softkey.
If there is no baseline loop saved in memory, the currently plotting loop will be saved automatically as the baseline loop.
2. If a baseline loop is already saved in memory, a dialog box will appear with the choices of "**Baseline**" and "**Reference**". Select "**Baseline**". A confirmation dialog will be displayed with the text "**Selecting Yes will replace the currently saved Baseline loop. Do you want to proceed?**" If "**Yes**" is selected, the currently saved baseline loop will be replaced. If "**No**" is chosen, the save will be aborted.

To save a reference loop:

1. From the main screen, select **Spirometry** tab > **Save Loop** softkey. If a baseline loop is already saved in memory, a dialog box will appear with the choices of "**Baseline**" and "**Reference**". Select "**Reference**".

A maximum of four (4) sets of reference loops plus one (1) Baseline loop and corresponding numeric data can be saved.

When the maximum of four (4) loops is reached, and the user attempts another save, a confirmation dialog will be displayed with the following text, "**Selecting Yes will replace the oldest reference loop. Do you want to proceed?**" If "**Yes**" is chosen, the oldest data will be removed as the new data is added. If "**No**" is chosen, the save will be aborted.

3.5.4 Review Loops Button

Selecting the **Review Loops** softkey (see FIGURE 3-21) displays the **Review Loops** screen (see FIGURE 3-22). The following areas and selections are displayed:

Small Loop Window: These small graphic windows show the baseline and reference loops. The baseline loop (only one) is always located on the left and has a white border around its graph. The reference loops (up to four) are located to the right of the baseline loop. The reference loops are displayed from oldest (left) to newest (right).

The baseline loop information is displayed below the small baseline loop window. The reference loop information is displayed in cyan highlight for the reference loop that is selected.

Large Loop Window: This graphic window shows an enlarged view of the selected reference loop overlapped with the baseline loop.

Loop Type: The **Loop Type** softkey is used to choose the type of loop to review. The choices are: **Pressure - Volume, Flow - Volume** and **Pressure - Flow**. Default loop type is **Pressure - Volume** loop.

Delete Loop: The **Delete Loop** softkey is used to delete a selected reference loop. When a reference loop is deleted, the newer reference loops will shift to the left. The **Delete Loop** softkey will be disabled (grayed out) if no reference loops have been saved. The baseline loop cannot be deleted. It can only be replaced by another baseline loop.

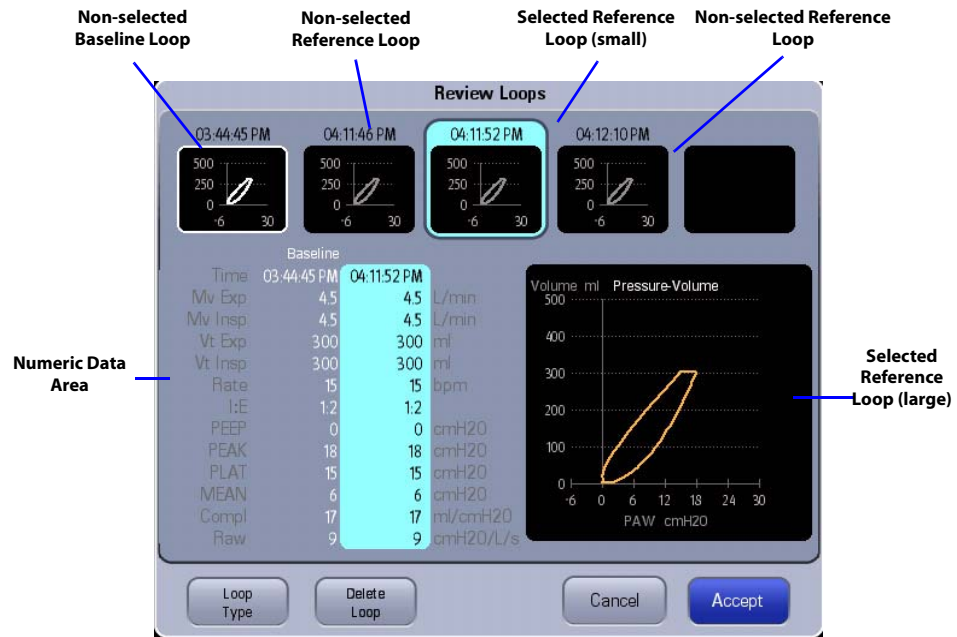

FIGURE 3-22 Review Loops window

Numeric Data Area: Displays the numerical data associated with a saved Baseline loop and saved Reference loops. The parameters listed in column form include:

- Time
- Expiratory Minute Volume (Mv Exp)
- Inspiratory Minute Volume (Mv Insp)
- Expiratory Tidal Volume (Vt Exp)
- Inspiratory Tidal Volume (Vt Insp)
- Ratio of Inspiratory time to Expiratory time (I:E)
- Positive End Expiratory Pressure (PEEP)
- Rate
- Peak Inspiratory Pressure (PEAK),
- Plateau Pressure (PLAT),
- Mean Pressure (MEAN),
- Dynamic Airway Compliance (Compl)
- Airway Resistance (Raw)

3.6 Demographics Tab

The **Demographics** tab is located on the main screen next to the Waveforms tab on the A3 system, and next to the Spirometry tab on the A5 system (see FIGURE 3-23). The Demographics tab contains editable fields to enter patient and hospital data (see TABLE 3-2).

NOTE: Facility data should be entered when first setting up the machine. After entering facility data, the user should go to the System tab > Manage Defaults > Save as O.R. Defaults so that the data is not erased in case of power cycle or end of case.

EDITABLE FIELD	COMMENT
Patient ID	Enter up to 30 characters per field. These fields are cleared when the case has ended or if the A5/A3 is power cycled.
First Name	
Last Name	
DOB (Date Of Birth)	Enter the information from the virtual keypad. If the input is outside the accepted range, a prompt message is displayed. If the age of the patient is less than 1, the Age will display < 1. These fields are cleared when the case has ended or if the A5/A3 is power cycled.
Age	
Weight (lbs/kg)	
Bed	Enter up to 20 characters per field. When the Restore default settings checkbox is selected, these fields are NOT cleared when the case has ended (applies to software bundle version 02.02.00 and later).
Room	
Point of Care	
Facility	

TABLE 3-2 Demographic Tab Fields for Patient and Hospital Data

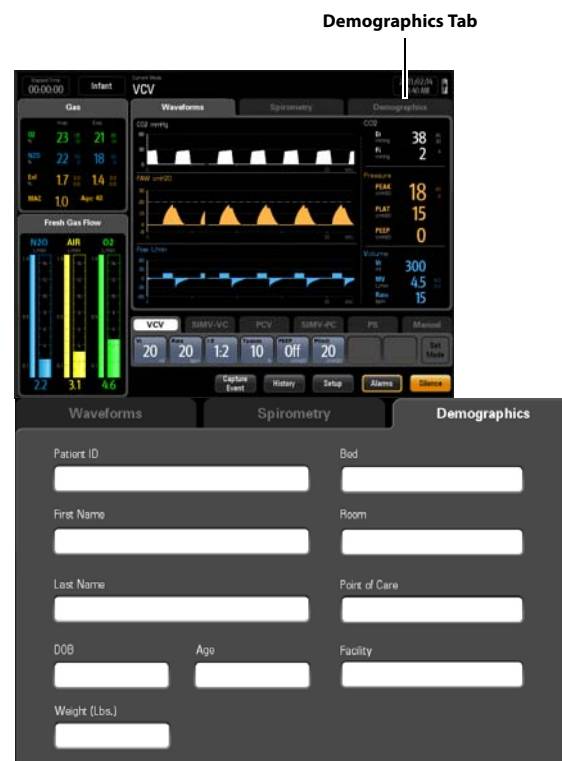

FIGURE 3-23 Demographics Tab

3.7 Ventilation Mode Tabs

Displays tabs for all ventilation modes. Each tab displays the ventilation mode and its parameters (see FIGURE 3-24 to FIGURE 3-31).

A5 ventilation modes:

- Volume Control Ventilation (VCV)
- Synchronized Intermittent Mandatory Ventilation with VC mode (SIMV-VC)
- Pressure Control Ventilation (PCV)
- Synchronized Intermittent Mandatory Ventilation with PC mode (SIMV-PC)
- Pressure Support ventilation (PS)
- Manual
- Bypass
- Monitor (with AG module)

A3 ventilation modes:

- Volume Control Ventilation (VCV)
- Synchronized Intermittent Mandatory Ventilation with VC mode (SIMV-VC)
- Pressure Control Ventilation (PCV)
- Pressure Support ventilation (PS)
- Manual (only A5 can have the AG module)

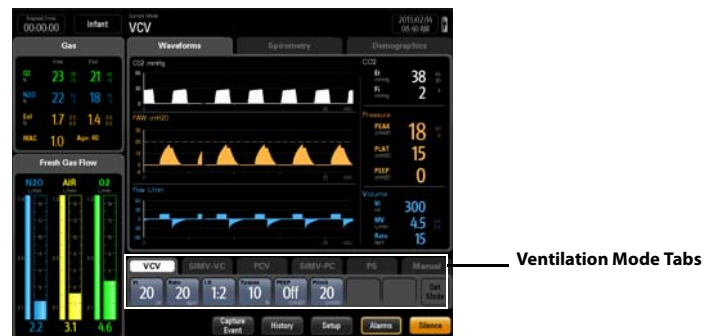

FIGURE 3-24 Ventilation Mode Tabs (with AG module installed)

To change the ventilation mode:

1. Select a desired ventilation mode tab. The **Set Mode** softkey begins to blink green.
2. Optionally, select one or more parameter buttons to change the parameter settings of the desired ventilation mode. Select the “Accept” button to save each parameter change.
3. Select the “Set Mode” softkey to finalize and change the ventilation mode.

NOTE: If the **Set Mode** softkey is not selected after several seconds, an audible reminder is sounded, and then the desired ventilation mode is cancelled.



FIGURE 3-25 Ventilation Mode: VCV



FIGURE 3-26 Ventilation Mode: SIMV-VC



FIGURE 3-27 Ventilation Mode: PCV (A5 unit)



FIGURE 3-28 Ventilation Mode: PCV (A3 unit)



FIGURE 3-29 Ventilation Mode: SIMV-PC (A5 only)



FIGURE 3-30 Ventilation Mode: PS

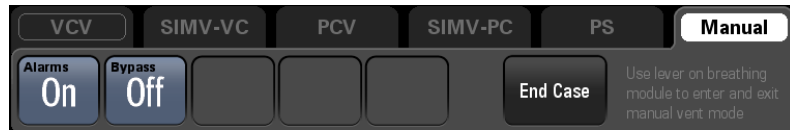

FIGURE 3-31 Ventilation Mode: Manual

NOTE: Bypass function is available only on the A5.



FIGURE 3-32 Ventilation Mode: Manual (with AG module installed)

NOTE: Bypass function is available only on the A5.

NOTE: Monitor mode available when external AG module connected.

3.8 Measured Values Area

The Measured Values area is used to display the numerical data. The parameters include: End tidal CO₂ (with AG module connected), Fractional CO₂ (with AG module connected), Peak Inspiratory Pressure (PEAK), Plateau Pressure (PLAT) (user can configure this to display Mean Pressure (MEAN) or PLAT (see "Pressure Display" on page 3-35)), Positive End Expiratory Pressure (PEEP), I:E Ratio, Expiratory Tidal Volume (Vt), Expiratory Minute Volume (MV), and Breath Rate (Rate), and Inspiratory O₂% (FiO₂). (FIGURE 3-33)

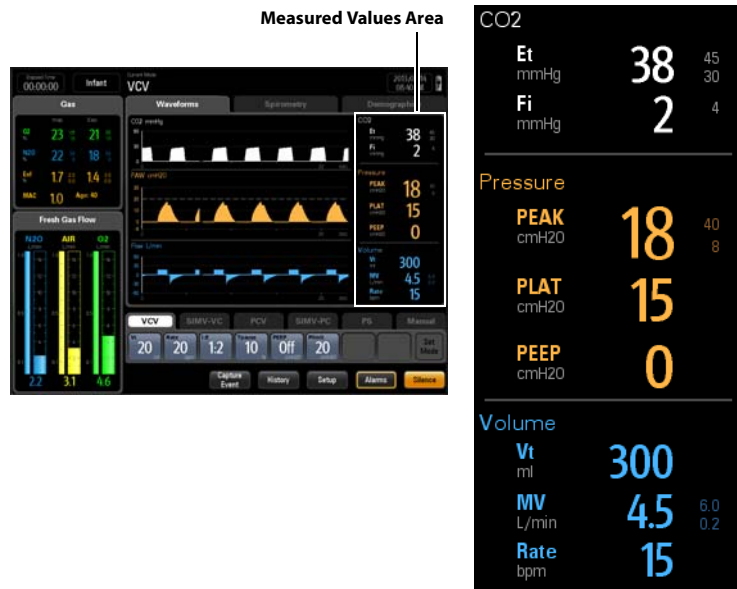

FIGURE 3-33 Measured Values Area (no AG module connected)

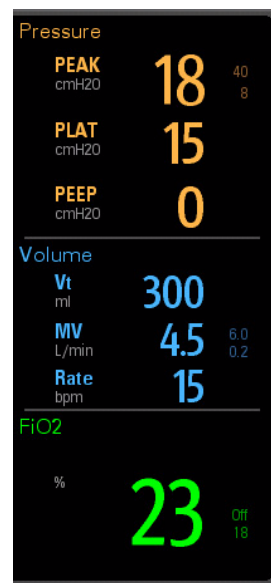

FIGURE 3-34 Measured Values Area (without AG module connected)

3.9 System Softkeys

The A5/A3 System provides system softkeys at the bottom right of the main screen for direct access to the history menu, system setup, and alarms menu, and for capturing events and silencing alarms (see FIGURE 3-35).



FIGURE 3-35 System Softkeys

3.9.1 Setup Softkey

Select the **Setup** softkey on the main screen to display the **Setup** menu. See FIGURE 3-35, "System Softkeys," on page 25.

The **Setup** menu contains the **General** tab, **Display** tab, **System** tab, and **Service** tab. See section 3.12 (page 3-34) "Display Tab".

3.9.2 Alarms Softkey

Select the **Alarms** softkey on the main screen to open the **Alarms** menu to set alarm limits, set alarm volume, and view all active alarms. See "Alarms and Messages" on page 6-1.

3.9.3 Silence Softkey

Select **Silence** softkey to silence all currently sounding alarm tones. The alarm will sound if a new alarm occurs.

If the silenced alarms contain middle or high level alarms, the alarm audio will be paused for 120 seconds. The alarm silence icon and 120 second countdown time appear at the top of the screen. Select again to resume the alarm audio. Note, however, the alarm will sound if a new alarm occurs while the system is in an audio-paused state. If this occurs, you can select the **Silence** softkey again to silence the new alarm and reset the silence countdown timer to 120 seconds.

Found in software bundle version 02.04.00 and later:

If the silenced alarms are only low level alarms, the alarm audio will be turned off till there is a new alarm occurs. Note, however, the alarm will sound if a new alarm occurs while the system is in an audio-off state. If the new alarm is low level alarm, you can select the **Silence** softkey again to turn off the new alarm audio. If the new alarm is medium or high level alarm, you can select the **Silence** softkey again to silence the new alarm for 120 seconds.

3.9.4 Capture Event (software bundle version 02.02.00 and later)

Select the **Capture Event** softkey on the main screen to capture parameters and log it in the **Event Log** (see FIGURE 3-38). The **Capture Event** softkey is disabled when the machine is in **Standby**.

3.9.5 History (software bundle version 02.02.00 and later)

Select the **History** button on the main screen to access a patient's historical physiological parameters. The History dialog contains **List Trends**, **Graphic Trends** and an **Event Log** tab.

Found in software bundle version 02.06.00 and later:

There is an interactive link among the three history tabs. When switching between tabs, the cursor will automatically position itself on the corresponding record that was selected in the previous tab.

3.9.5.1 List Trends

Select the **History** button on the main screen to access the **List Trends**. The **History** dialog displays (see FIGURE 3-36) with the **List Trends** tab selected.

The List Trends displays a tabular list of the physiological parameters. Trend data automatically displays in one minute intervals unless an alternate interval is selected.

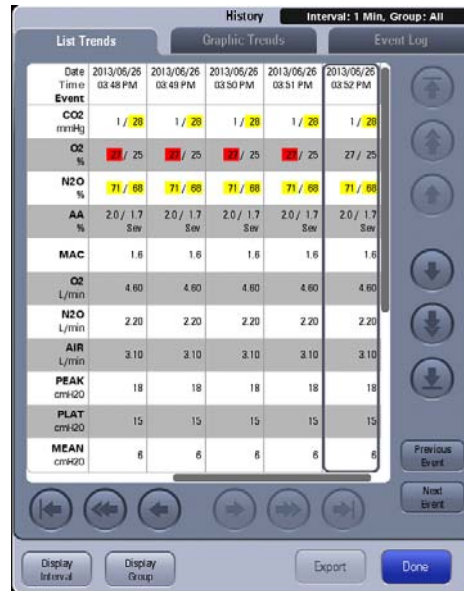

FIGURE 3-36 List Trends



3.9.5.1.1 About List Trends

- List Trends displays the time and date on the horizontal axis and it is always visible.
- List Trends displays the parameter name on the vertical axis and it is always visible.
- List Trends displays the trend records in descending order beginning with the most recent on the right side of the grid.
- List Trends are not stored when the machine is in standby.
- The display period of data is a rolling 48 hours of continuous data.
- List Trends highlights the parameter data in the corresponding alarm color if an alarm condition existed for the parameter at the time of trend record storage.

3.9.5.1.2 Navigating in List Trends

The dialog navigation buttons are described in TABLE 3-3.

NOTE: When a navigation button becomes disabled, this indicates that there is no more data available or the end of the data range was reached.

BUTTON	FUNCTION
	Moves the cursor to the oldest record from its current position.
	Moves the cursor one page back from its current position.







BUTTON	FUNCTION
	Moves the cursor one record back from its current position.
	Moves the cursor one record forward from its current position.
	Moves the cursor one page forward from its current position.
	Moves the cursor to the newest record from its current position.
Previous Event	Moves the cursor to the previous event from its current position.
Next Event	Moves the cursor to the next event from its current position.
	Moves the cursor up one parameter from its current position.
	Moves the cursor down one parameter from its current position.

TABLE 3-3**3.9.5.1.3****Display Interval**

Display Interval allows for the trends to be displayed in a specified time interval between two neighboring columns.

Set **Display Interval** to **1 Min, 5 Min, 10 Min, 15 Min, 30 Min, 1 Hour, or 2 Hour**.

3.9.5.1.4**Display Groups**

Display Group allows for the trends to be displayed in a specified parameter group.

Set **Display Group** to **Gas, Fresh Gas, Ventilation, or All**.

3.9.5.1.5**List Trend Export (software bundle version 02.06.00 and later)**

The **Export** button on the **List Trend** tab will allow the contents of the history to be exported to a USB mass storage device. The format of the data exported is a .html file which can be opened using Internet Explorer version 6.0, 7.0 and 8.0. The **Export** button on the **List Trend** tab is only available when the system is in **Standby** mode.

NOTE: If Internet Explorer greater than version 8.0 is used to view the exported file, set it to compatibility mode.

3.9.5.2**Graphic Trends (software bundle version 02.04.00 and later)**

Select the **History** button on the main screen and then select the **Graphic Trends** tab to access the **Graphic Trends**. The History dialog displays (see FIGURE 3-37) with the Graphic Trends tab selected.

Graphic trends display allows the user to observe the trend of the physiological parameters. The trend is reflected through a curve. Every point on the curve corresponds to the parameter value at a specific time point. Graphic Trends tab displays end case event, captured event and parameter alarm event. Graphic trend data automatically displays in one minute intervals unless the zoom is selected.

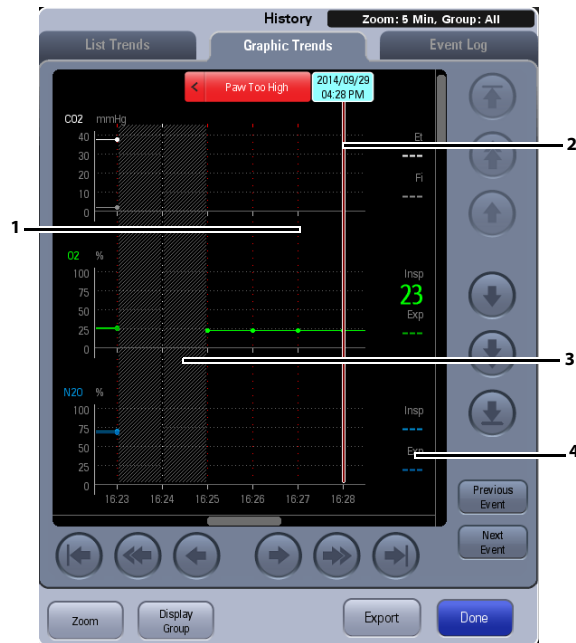

FIGURE 3-37 Graphic Trends

NUMBER	DESCRIPTION
1	Event marker. The dotted, colored line indicates an event occurred at that time. Events could be any of the following: end case, capture an event or a physiological alarm occurrence. For end case or capture an event, the dotted line is white. For physiological alarm occurrence, the dotted line is in the same color as alarm. If multiple events occurred, dotted line is in same color as the event of the highest alarm level. The event level can be specified as: high alarm level event > medium alarm level event > low alarm level event > capture event > end case event.
2	Current cursor. The corresponding time displays above the cursor. If alarms or events occurred at that time, the corresponding alarm information or events will also display above the cursor (hereinafter referred to as event bubble). Found in software bundle version 02.06.00 and later: Clicking on the event bubble will cause the event log tab (see FIGURE 3-38) to open on that specific event.
3	An end case event occurred during this period.
4	The parameter data of the time indicated by cursor.

TABLE 3-4

NOTE: The Graphic Trends will be cleared after the anesthesia machine undergoes power failure or is turned off.

3.9.5.2.1 About Graphic Trends

- Graphic Trends store the data with the interval in 1 minute.
- Graphic Trends displays the trend records in descending order beginning with the most recent on the right side of the grid.
- Graphic Trends are not stored when the machine is in standby.
- The display period of data is a rolling 48 hours of continuous data.
- Graphic Trends highlights the parameter data in the corresponding alarm color if an alarm condition existed for the parameter at the time of trend record storage.

3.9.5.2.2 Navigating in Graphic Trends

The dialog navigation buttons are described in TABLE 3-5.

NOTE: When a navigation button becomes disabled, this indicates that there is no more data available or the end of the data range was reached.









BUTTON	FUNCTION
	Moves the cursor to the oldest record from its current position.
	Moves the cursor one page back from its current position.
	Moves the cursor one record back from its current position.
	Moves the cursor one record forward from its current position.
	Moves the cursor one page forward from its current position.
	Moves the cursor to the newest record from its current position.
Previous Event	Moves the cursor to the previous event from its current position.
Next Event	Moves the cursor to the next event from its current position.
	Moves the cursor up one parameter from its current position.
	Moves the cursor down one parameter from its current position.

TABLE 3-5

3.9.5.2.3 Zoom

Zoom allows the trends to be displayed in one page in a specified time interval.

Set **Zoom** to **5Min**, **10Min**, **15Min**, **30Min**, **1Hour**, or **2Hour**.

3.9.5.2.4 Display Groups

Display Group allows for the trends to be displayed in a specified parameter group.

Set **Display Group** to **Gas**, **Fresh Gas**, **Ventilation**, or **All**.

3.9.5.2.5 Graphic Trends Export (software bundle version 02.06.00 and later)

The **Export** button on the **Graphic Trends** tab will allow the contents of the history to be exported to a USB mass storage device. The format of the data exported is a .html file which can be opened using Internet Explorer version 6.0, 7.0 and 8.0. The **Export** button on the **Graphic Trends** tab is only available when the system is in **Standby** mode.

NOTE: If Internet Explorer greater than version 8.0 is used to view the exported file, set it to compatibility mode.

3.9.5.3 Event Log

Select the **History** button on the main screen and then select the **Event Log** tab to access the **Event Log**. The History dialog displays (see FIGURE 3-38) with the Event Log tab selected.

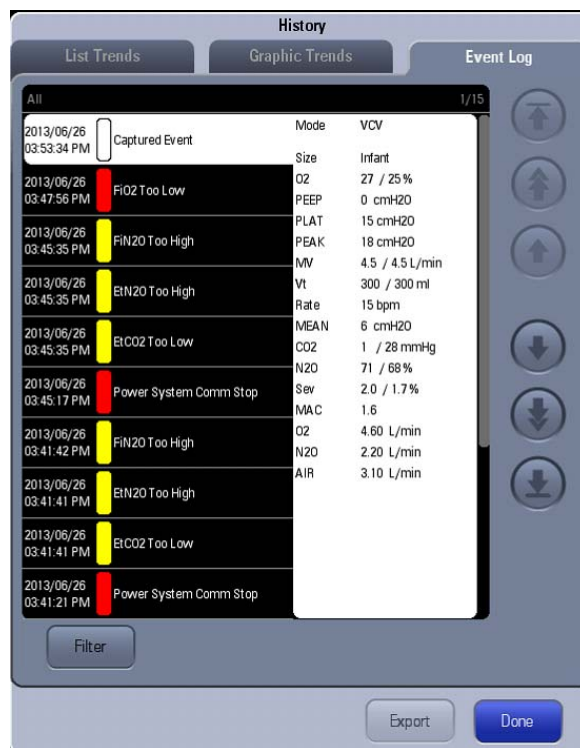

FIGURE 3-38 Event Log

The **Event Log** tab logs such events as technical alarms, physiological alarms, capture events, delay power off, end case, delay power off canceled and system time change. Events can be physiological indicating that a patient's physiological alarm thresholds have been violated or technical indicating that a specific technical issue has occurred.

An alarm entry and captured events in the Event Log displays the time, date, event, priority and additional information which includes the Ventilation Mode, Patient Size, and Monitored Parameters.

NOTE: **The Event log will be cleared after the anesthesia machine undergoes power failure or is turned off.**

3.9.5.3.1 Navigating in the Event Log

The dialog navigation buttons are described in TABLE 3-6.

NOTE: **When a navigation button becomes disabled, this indicates that there is no more data available or the end of the data range was reached.**







BUTTON	FUNCTION
	Moves the scroll up one record.
	-Moves the scroll up one page.
	Moves the scroll to the top most parameter.
	Moves the scroll down one record.
	Moves the scroll down one page.
	Moves the scroll to the bottom most parameter.

TABLE 3-6

3.9.5.3.2 Event Log Filter

The **Filter** button allows for the Event Log Entries trends to be displayed in a similar Event type.

Set **Filter** to **High, Medium, Low, Informational** or **All**. The A5 will display the corresponding event based on your setting.

3.9.5.3.3 Event Log Export

The **Export** button on the **Event Log** tab will allow the contents of the history to be exported to a USB mass storage device. The format of the data exported is a .html file which can be opened using Internet Explorer version 6.0, 7.0 and 8.0. The **Export** button on the **Event Log** tab is only available when the system is in **Standby** mode.

NOTE: **If Internet Explorer greater than version 8.0 is used to view the exported file, set it to compatibility mode.**

3.10 Setup

Select the **Setup** softkey (see FIGURE 3-35) to open the **Setup** menu (see FIGURE 3-39).

The **Setup** menu contains the **General** tab, **Display** tab, **System** tab, and **Service** tab. See section 3.12 (page 3-34) "Display Tab".

NOTE: The **System** tab is only available in **Standby** mode.

NOTE: The **Service** tab is for use only by **Mindray Technical Service**. Please contact **Mindray Technical Support** for details.

Many of these functions are only available if the A5/A3 is in **Standby** mode.

3.11 General Tab

The **General** tab provides access to calibrate the O₂ sensor and flow sensor, perform system leak and compliance tests, activate the breathing system warmer, and zero flow meters. The **General** tab also displays information for the most recent calibrations and leak test results, whether they were passed, failed, or skipped (see FIGURE 3-39).

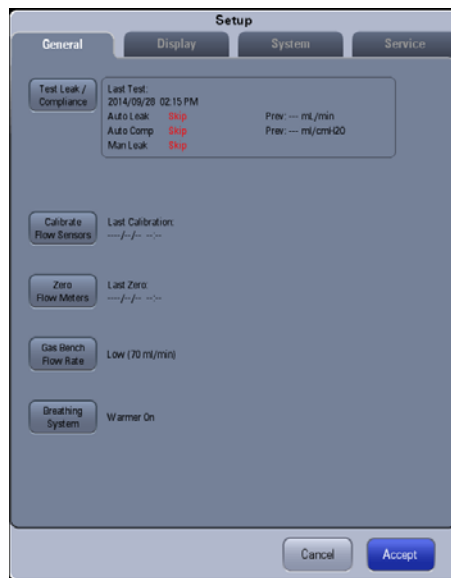

FIGURE 3-39 General Tab (with AG module connected)

Calibrate O₂ Sensor (without AG module connected)

To calibrate the O₂ sensor, select the **Calibrate O₂ Sensor** button. Follow the on-screen instructions and prompts. See "O₂ Sensor Calibration" on page 7-6 for more information. Note that information for the last O₂ sensor calibration is displayed next to the button.

Calibrate Flow Sensor

To calibrate the flow sensor, select the **Calibrate Flow Sensor** button. Follow the on-screen instructions and prompts. See "Flow Sensor Calibration" on page 7-5 for more information. Note that information for the last flow sensor calibration is displayed next to the button.

Leak Test / Compliance

The **Test Leak / Compliance** button enables the A5/A3 system to perform a manual leak test and automatic leak test, and calculates the compliance for the A5/A3.

To perform a leak test, select the **Test Leak/Compliance** button. Follow the on-screen instructions and prompts. See “Leak and Compliance Tests” on page 4-9 for more information. Note that information for the last Leak Test / Compliance is displayed next to the button.

Breathing System Warmer

To set the breathing system warmer, select **Warmer On** (default) or **Warmer Off**. If the warmer is off or if AC power is not connected, the system displays an icon to indicate that the warmer is not active (see FIGURE 3-40).



FIGURE 3-40 Warmer Inactive Icon

After cycling power, the breathing system warmer will return to the default state.

NOTE: **The breathing system warmer is inactive when the A5/A3 is powered by the battery supply.**

Zero Flow Meters

To zero the flow meters, select the **Zero Flow Meters** button. Follow the on-screen instructions and prompts. Note that information for the last zeroing of the flow meters is displayed next to the button.

NOTE: **Before zeroing the flow meters, make sure to disconnect the gas supply (N₂O, Air, O₂).**

Gas Bench Flow Rate

To set the gas bench flow rate, select the **Gas Bench Flow Rate** button. The flow rate can be set to High, Medium, or Low (default).

3.12 Display Tab

The **Display** tab provides access to screen cleaning, screen calibration, pressure parameter display, CO2 waveform placement, gas scales, waveform display, screen brightness and key click volume (see FIGURE 3-41).

Screen Brightness

To adjust the screen brightness:

1. Select **Setup** softkey > **Display** tab (See FIGURE 3-41).
2. In the **Screen Brightness** area, select the +/- buttons to adjust the screen brightness.
3. Select the **Accept** button to confirm the change, or select **Cancel** button to discard the change.

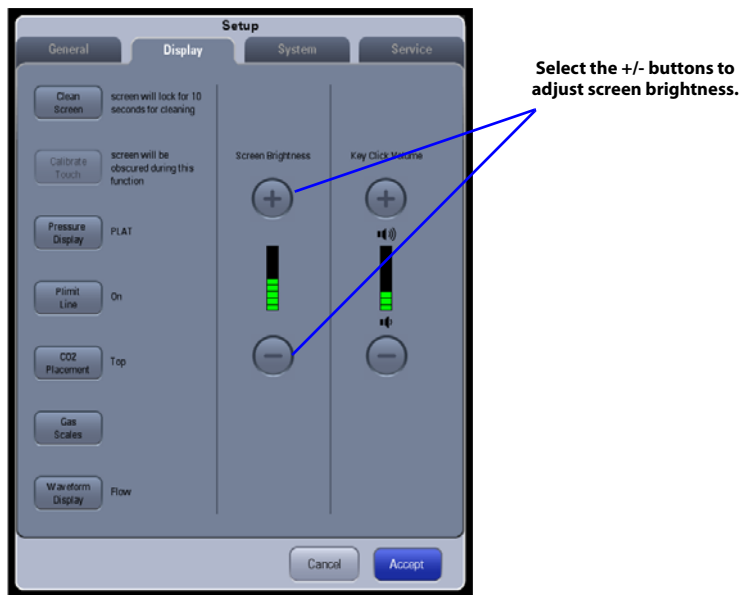

FIGURE 3-41 A5/A3 Display Tab> Screen Brightness Area

Key Click Volume

To adjust the key click volume:

1. Select **Setup** softkey > **Display** tab.
2. In the **Key Click Volume** area, select the +/- buttons to adjust the key click volume.
3. Select the **Accept** button to confirm the change, or select **Cancel** button to discard the change.

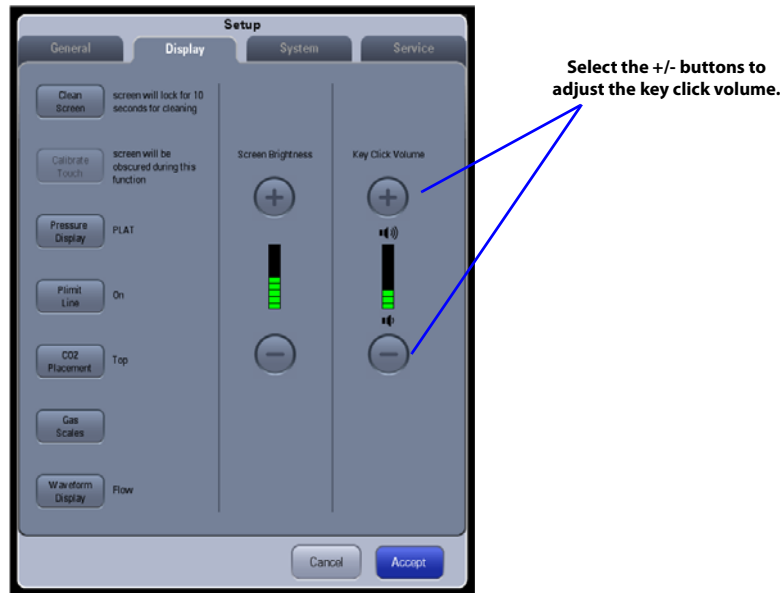

FIGURE 3-42 A5/A3 Display Tab > Key Click Volume Area

Clean Screen

To clean the LCD touch screen:

1. Select **Setup** softkey > **Display** tab.
2. Select the **Clean Screen** button.
The screen will lock for 10 seconds for cleaning.

Calibrate Touch

To calibrate the LCD touch screen:

1. Select **Setup** softkey > **Display** tab.
2. Select the **Calibrate Touch** button.
3. Follow the on-screen instructions.

Pressure Display

To change the pressure display:

1. Select **Setup** softkey > **Display** tab.
2. Select the **Pressure Display** button.
3. Choose between **MEAN** and **PLAT**.

4. Select the **Accept** button to confirm the change, or select **Cancel** button to discard the change.

Plimit Line

The Plimit line function displays a dashed line in the Pressure waveform area to indicate the Plimit position. The Plimit line can be displayed in VCV, SIMV-VC, and PCV with VG on mode. The Plimit line function can be switched On or Off by the user. The default value for Plimit Line is On.

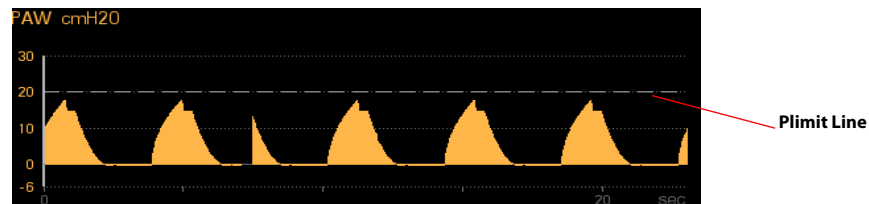

FIGURE 3-43 Plimit Line

NOTE: The Plimit line does not affect the auto-scaling algorithm. If the Plimit line is turned on but not visible, it may be because the line is positioned off the waveform scale.

To set the Plimit Line to ON or OFF:

1. Select **Setup** softkey > **Display** tab.
2. Select the **Plimit Line** button to ON or OFF.
3. Select the **Accept** button to confirm the change, or select **Cancel** button to discard the change.

CO₂ Placement (with an AG module connected)

The CO₂ waveform/data can be positioned at the top or bottom of the Waveform area.

To set the CO₂ placement:

1. Select **Setup** softkey > **Display** tab.
2. Select the **CO₂ Placement** button.
3. Select **Top** or **Bottom**.
4. Select the **Accept** button to confirm the change, or select **Cancel** button to discard the change.

CO₂ Scale (with an AG module connected)

The CO₂ scale of the CO₂ waveform can be adjusted to one of three settings. The table below shows the CO₂ scale options.

To set the CO₂ scale:

1. Select **Setup** softkey > **Display** tab.
2. Select the **CO₂ Scale** button.

3. Select the desired scale setting according to the table below.:

CO ₂ UNIT OF MEASURE	SCALE		
mmHg	0-40	0-60	0-80
kpa	0.0-5.0	0.0-8.0	0.0-10.0
%	0.0-5.0	0.0-8.0	0.0-10.0

TABLE 3-7 CO₂ Scale

4. Select the **Accept** button to confirm the change, or select **Cancel** button to discard the change.

Gas Scales (software bundle version 02.06.00 and later, with an AG module connected)

To set the Gas scales:

1. Select **Setup** softkey > **Display** tab.
2. Select the **Gas Scales** button.
3. Select the **CO₂ Scale, AA Scale, O₂ Scale or N₂O Scale** button. If an aesthetic agent, such as sevoflurane, is detected, the system displays **Sev Scale** instead of **AA Scale**.
4. Select the desired scale setting according to the table below:

GAS SCALES	UNIT OF MEASURE	SCALE		
CO ₂ Scale	mmHg	0-40	0-60	0-80
	kPa	0.0-5.0	0.0-8.0	0.0-10.0
	%	0.0-5.0	0.0-8.0	0.0-10.0
O ₂ Scale	%	0-35	0-50	0-100
N ₂ O Scale	%	0-35	0-50	0-100
Des Scale	%	0.0-6.0	0.0-9.0	0.0-18.0
Sev Scale	%	0.0-2.0	0.0-4.0	0.0-8.0
Iso Scale	%	0.0-1.2	0.0-2.5	0.0-5.0
Hal Scale	%	0.0-1.2	0.0-2.5	0.0-5.0
Enf Scale	%	0.0-1.2	0.0-2.5	0.0-5.0

TABLE 3-8 Gas Scales

5. If needed, select the **Load Scales Defaults** button and then select the **Yes** button to restore the factory default configurations. Select the **Accept** button to confirm the change, or select the **Cancel** button to discard the change.

GAS SCALE	FACTORY DEFAULT SCALE		
CO ₂ Scale	0-60 mmHg	0.0-8.0 kPa	0.0-8.0 %
O ₂ Scale	0-100 %		
N ₂ O Scale	0-100 %		
Des Scale	0-9.0 %		
Sev Scale	0-4.0 %		
Iso Scale	0-2.5 %		

TABLE 3-9 Factory default scale

GAS SCALE	FACTORY DEFAULT SCALE
Hal Scale	0-2.5 %
Enf Scale	0-2.5 %

TABLE 3-9 Factory default scale

Waveform Display (software bundle version 02.02.00 and later)

To set the waveform display:

1. Select **Setup** softkey > Display tab.
2. Select the **Waveform Display** button.
3. Select the desired waveform.
4. Select the **Accept** button to confirm the change, or select **Cancel** button to discard the change.

3.13 System Tab

The **System** tab is accessible only by authorized administrative service personnel with password access. The system tab can only be accessed in **Standby** mode.

NOTE: The default **System** tab password is: **1234**. The authorized administrator should change the default password immediately after the system is installed to prevent unauthorized access to the **System** tab. The password can be maximum of 6 digits in length containing numerals 0 to 9.



FIGURE 3-44 A5/A3 Setup Menu > System Tab

SYSTEM TAB BUTTON	CHOICES	DESCRIPTION
Calibration	External AG Module O₂ Sensor	Select to calibrate the External AG Module or O ₂ sensor. Follow the screen instructions. The date and time of the last calibration is displayed next to the O₂ Sensor or External AG Module button. NOTE: The AG module information appears only when an AG module is connected to the A5 system.
Language	ENGLISH (default) CHINESE FRENCH SPANISH	Select to set the user interface text language.
Default Settings	Default Patient Size (default= Infant, Adult, Pediatric) Default Vent Mode (default= VCV, SIMV-VC, PCV, SIMV-PC, PS) NOTE: Default changes take effect after next case or when O.R. defaults are loaded.	Select to set the default patient size. Select to set the default mechanical ventilation mode. For default changes to take effect: 1. Press Accept. 2. Start next case. 3. End case.
Manage Defaults	Save Defaults Save as O.R. Defaults Load User Defaults Load O.R. Defaults Restore Partial Defaults Import Defaults Export Defaults	Select "Save Defaults" or "Save as O.R. Defaults" to save the current configuration as the user default configuration. Select "Load User Defaults" or "Load O.R. Defaults" to load the user default configuration. Select "Restore Partial Defaults" to overwrite the user defaults and system settings with the factory default settings. Note that network settings will not be restored. Select "Import Defaults" to import a copy of the defaults from the USB mass storage device if one has been inserted into an SB port at the rear of the A5/A3 unit. Select "Export Defaults" to export a copy of the defaults to the USB mass storage device if one has been inserted into an SB port at the rear of the A5/A3 unit.

TABLE 3-10 System Tab Settings

SYSTEM TAB BUTTON	CHOICES	DESCRIPTION
Time Settings	Time Zone (Default = UTC-05:00)	Select to set the UTC time zone offset.
	Daylight Savings (Default = Manual, Auto)	Select to set the Daylight Savings Time (DST) to be adjusted automatically by the A5 system, or manually by the authorized administrator. If the region or country of installation does not observe DST, change this setting to Manual. If Daylight Savings is set to Auto, the Daylight Savings Time On/Off button in the Date/Menu dialog becomes inactive and cannot be selected (see FIGURE 3-12).
	DST Start (Default = First Sunday in April at 2:00 AM)	Select to set the START of Daylight Savings Time. This setting is not available if DST is set to Manual.
	DST End (Default = Last Sunday in October at 3:00 AM)	Select to set the END of Daylight Savings Time. This setting is not available if DST is set to Manual.
Network	See section 3.13.1 (page 3-41) "Network Configuration".	
Change Password	1234 (default)	Select to change the System tab password. The authorized administrator should change the default password immediately after the system is installed to prevent unauthorized access to the System tab. The password can be up to 6 digits in length containing numerals 0 to 9.
Units	Pressure (default= cmH₂O, hPa, mbar)	Select to set the Pressure unit of measure.
	CO₂ (default= mmHg, kPa, %)	Select to set the CO ₂ unit. NOTE: The Set CO₂ Unit button only displays if an external AG module is connected to the A5.

TABLE 3-10 System Tab Settings

SYSTEM TAB BUTTON	CHOICES	DESCRIPTION																		
Configuration Information	—	<p>Select to display the machine ID and the status of system functions.</p>  <table border="1"> <caption>Configuration Information</caption> <thead> <tr> <th>Function</th> <th>Status</th> </tr> </thead> <tbody> <tr> <td>VCV</td> <td>Activated</td> </tr> <tr> <td>PCV</td> <td>Inactivated</td> </tr> <tr> <td>PCV-VG</td> <td>Activated</td> </tr> <tr> <td>SIMM-VC</td> <td>Activated</td> </tr> <tr> <td>SIMM-PC</td> <td>Activated</td> </tr> <tr> <td>PS</td> <td>Inactivated</td> </tr> <tr> <td>Bypass</td> <td>Activated</td> </tr> <tr> <td>Spirometry</td> <td>Activated</td> </tr> </tbody> </table>	Function	Status	VCV	Activated	PCV	Inactivated	PCV-VG	Activated	SIMM-VC	Activated	SIMM-PC	Activated	PS	Inactivated	Bypass	Activated	Spirometry	Activated
Function	Status																			
VCV	Activated																			
PCV	Inactivated																			
PCV-VG	Activated																			
SIMM-VC	Activated																			
SIMM-PC	Activated																			
PS	Inactivated																			
Bypass	Activated																			
Spirometry	Activated																			
Export Data	—	Select to export patient data via mass storage device.																		
Clear History	On (default) Off	<p>Configures the Clear History setting at the end of the case.</p> <p>When turned on, event logs and all trends will be deleted at the start of the case.</p> <p>When turned off, event logs and all trends will not be deleted at the start of the case.</p> <p>NOTE: Button only appears for software bundle version 02.02.00 and later.</p>																		

TABLE 3-10 System Tab Settings

3.13.1 Network Configuration

Network configuration settings can be set via the **Network** button (see FIGURE 3-45). Select main screen > **Setup** button > **System** tab > **Network** button.

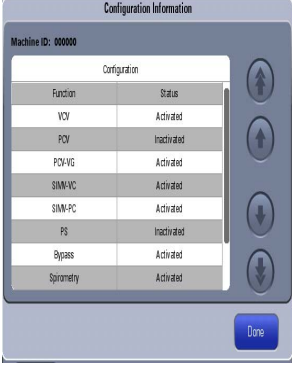
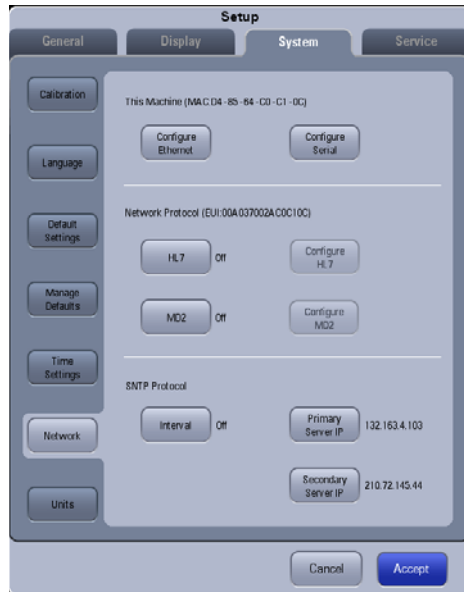

FIGURE 3-45 Network Configuration Screen

TABLE 3-11 lists the network settings and parameters.

NOTE: **MAC and EUI (Extended Unique Identifier) values are displayed on software bundle version 02.02.00 and later.**

NOTE: **Set HL7 Compatibility displayed on Network Configuration Screen is available in software bundle version 02.06.00 and later.**

SETTINGS	PARAMETERS
This Machine	
Configure Ethernet	Enter: • IP Address (default = 192.168.23.250) • Subnet (default = 255.255.255.0) • Default Gateway (default = [blank])

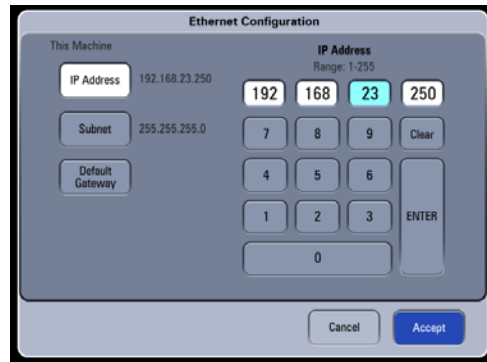



TABLE 3-11 Network Configuration Settings and Parameters

SETTINGS	PARAMETERS
Configure Serial	<p>Select:</p> <ul style="list-style-type: none"> • Protocol (None (default), MR-Link/HL7, MR-WATO, Philips (software bundle version 02.09.00 and later)) • Baud Rate (57600, 11520 (default)) • Data Bits (8 (default), 7, 6, 5) • Stop Bits (1(default), 2) • Parity (Odd, Even, None (default)) • Interval: <ul style="list-style-type: none"> Enabled when Protocol=None: Off (default); Enabled when Protocol=HL7: 10 Sec, 30 Sec, 1 Min (default), 5 Min, 30 Min, 1 Hour, 2 Hour, 6 Hour, 12 Hour, 24 Hour. <p>NOTE: MR-Link renamed to HL7 on software bundle version 02.02.00 and later.</p> <p>NOTE: When Protocol is set to MR-WATO, the A5 can communicate with the patient monitor of Mindray through Benelink module of Mindray.</p> <p>NOTE: When Protocol is set to Philips, the A5 can communicate with the patient monitor of Philips through IntelliBridge or VueLink module of Philips.</p>
	

Network Protocol

TABLE 3-11 Network Configuration Settings and Parameters

SETTINGS	PARAMETERS
Configure HL7	Interval(10 sec, 30 sec, 1 min (default), 5 min, 30 min, 1 hour, 2 hour, 6 hour, 12 hour, 24 hour) Destination IP (default = 192.168.23.200) Port (default = 1550) Set HL7 Compatibility(Most Recent (Default), 02.02.01 to 02.10.00, 02.00.00, 01.05.02, 01.00.00 to 01.05.01, None) Send Waveforms(Off(Default), On) Send Alarms(Off(Default), On) Send Alarm Ack.(Off(Default), On)
	
MD2 (software bundle version 02.09.00 and later)	Select: On, Off (default)
	<p>NOTE: MD2 is a communication protocol. The A5 can connect to the eGateway through MD2, and communicates with the devices connected to the eGateway.</p>
Configure MD2 (enabled when MD2 = On)	Destination IP (default = 192.168.23.99) Port (default = 6678)
SNTP Protocol	
Interval	Select: Off (default), 10 sec, 30 sec, 1 min, 5 min, 30 min, 1 hour, 2 hour, 6 hour, 12 hour, 24 hour
Primary Server IP	Enter: Primary Server IP (default = 132.163.4.103)
Secondary Server IP	Enter: Secondary Server IP (default = 210.72.145.44)

TABLE 3-11 Network Configuration Settings and Parameters

3.14 Service Tab

Accessible only by Mindray-authorized service personnel. Please contact Mindray Technical Support for assistance.

Preoperative Tests

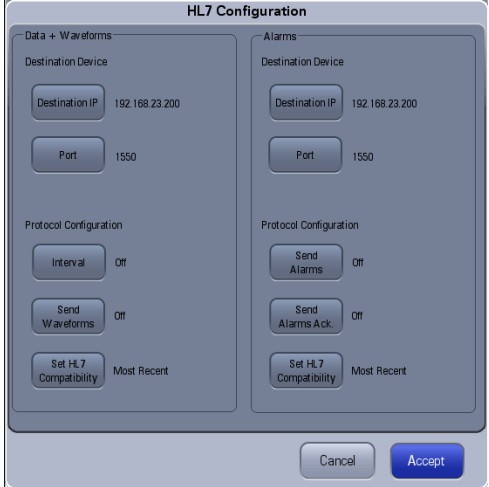
Preoperative Test Schedules	4-2
Inspect the System	4-3
Pre-Operative Checkout List.....	4-4
System Self-Test	4-6
Leak and Compliance Tests	4-9
Preoperative Check List (software bundle version 02.09.00 and later).....	4-17
Pipeline Tests	4-18
Basic Ventilation Testing	4-19
Cylinder Tests.....	4-20
Flow Control System Test.....	4-21
Vaporizer Tests	4-22
Breathing System Tests	4-24
Alarm Tests.....	4-26
Preoperative Preparations	4-28
Inspect the Active AGSS	4-29

4.1 Preoperative Test Schedules

Preoperative tests on the A5/A3 follow the ASA guidelines and should be performed according to the test intervals listed below. Refer to special procedures or precautions in this manual.

NOTE: This is a guideline which can be modified to accommodate variations in local clinical practice. Such local modifications should have appropriate peer review.

NOTE: It is recommended that the user check that N₂O cutoff and O₂/N₂O ratio are normal before use. Use an O₂ concentration tester to monitor the O₂ concentration in the gas output.

4.1.1 Test Intervals

Perform the preoperative tests listed below at these events:

- **When required after a maintenance or service procedure**
- **Every day before the first patient:**
 - System Self-Test (Section 4.4)
 - Leak and Compliance Tests (Section 4.5)
 - Pipeline Tests (Section 4.8)
 - Basic Ventilation Testing (Section 4.9)
 - Cylinder Tests (Section 4.10)
 - Flow Control System Test (Section 4.11)
 - Vaporizer Tests (Section 4.12)
- **Before each patient:**
 - Inspect the System (Section 4.2)
 - Pre-Operative Checkout List (Section 4.3)
 - Perform the Leak/Compliance Test (Section 4.5)
 - Preoperative Check List (software bundle version 02.09.00 and later) (Section 4.6)
 - Breathing System Tests (Section 4.13)
 - Alarm Tests (Section 4.14)
 - Preoperative Preparations (Section 4.15)
 - Inspect the Active AGSS (Section 4.16)

NOTE: Read and understand the operation and maintenance of each component before using the A5/A3 anesthesia machine.

NOTE: Do not use the A5/A3 anesthesia machine if a test failure occurs. Contact Mindray Technical Support for assistance.

NOTE: A checklist of the anesthetic system should be provided, including anesthetic gas delivery system, monitoring device, alarm system, and protective device, which are intended to be used for the anesthetic system, whether they are used alone or assembled together.

4.2 Inspect the System

NOTE: Ensure that the breathing system is correctly connected and not damaged.

Perform the following inspection checklist before operating the A5/A3 unit:

1. The A5/A3 anesthesia machine is correctly connected and undamaged.
2. Inspect the system for:
 - a. Damage to flowmeters, vaporizers, gauges, supply hoses
 - b. Complete breathing system with adequate CO₂ absorbent Pre-Pak or loose fill
 - c. Correct mounting of cylinders in yokes
 - d. Presence of cylinder wrench
 - e. Auxiliary O₂ supply, available and functioning
3. Check that:
 - a. Gas cylinders are turned off until needed to prevent the unintended use of gases
 - b. Flow-control valves are off
 - c. Vaporizers are off
 - d. Vaporizers are filled (not overfilled)
 - e. Filler caps are sealed tightly
 - f. Only one vaporizer can be turned on at the same time
4. All components are correctly attached.
5. The breathing system is correctly connected, the breathing tubes are undamaged, and the self-inflating manual ventilation device is available and functioning.
6. The gas supplies are connected and the pressures are correct.
7. Cylinder valves are closed on models with cylinder supplies (Verify that the cylinder wrench is attached).
8. The necessary emergency equipment is available and in good condition.
9. Equipment for airway maintenance and tracheal intubation is available and in good condition.
10. Inspect the color of the soda lime in the canister. Replace the soda lime immediately if obvious color change is detected. The soda lime is white when new. If it is purple, it must be changed.

WARNING: Check if the gasket is properly installed in place while installing the absorber canister. If the gasket is not properly installed (for example, gasket is not evenly seated and centered) it may cause breathing system leakage.

11. Applicable anesthetic and emergency drugs are available.
12. The casters are not damaged or loose, and the brake (s) is set and prevents movement.
13. Ensure the breathing system is in proper position.
14. The AC mains indicator and the battery indicator are displayed when the power cord is connected to the AC power source. If the indicators are not displayed, the system does not have electrical power.
15. The A5/A3 anesthesia machine is switched on or off normally.

4.3 Pre-Operative Checkout List

4.3.1 Introduction

The purpose of the pre-operative checkout is to detect potential system problems before use.

An effective method for detecting pneumatic circuit occlusions, leaks, and other system problems can be found in the A5/A3 pre-operative checkout procedures. In addition, it is recommended that the breathing circuit be tested for the ability to effectively deliver positive pressure ventilation before beginning each case. Testing the ability to properly ventilate a test lung can quickly identify an occluded circuit limb and other breathing circuit problems.

Before starting each case, test the machine's ability to ventilate the patient by removing the breathing bag from the bag arm and connecting it to the patient connection (elbow or Y-piece on the disposable circuit). Set the ventilator to deliver a specific tidal volume to the test lung and verify the exhaled tidal volume monitor. Observe that the test lung (breathing bag) inflates as the bellows descends, and that the test lung deflates during the exhalation phase. Observe that the measured exhaled volume matches the tidal volume set on the ventilator. With the ventilator running, lower the fresh gas flow to zero and observe if the bellows rapidly falls with each exhalation. If this occurs, then a leak should be suspected, identified, and repaired.

This test should be performed before starting each case. By verifying that a test lung (breathing bag) can be manually and mechanically ventilated, this indicates that the A5/A3 is capable of ventilating a patient with the attached breathing circuit.

4.3.2 Suggested Pre-Operative Checkout List

Below is a suggested checkout list that should be conducted before administering anesthesia. This is a guideline which users are encouraged to modify according to their local clinical practice. Such local modifications should have appropriate peer review. Users should refer to the A5/A3 Operating Instructions for special procedures, precautions, and step-by-step instructions.

WARNING: To ensure proper machine operation, user safety, and patient safety, follow all checkout procedures established by the facility before administering anesthesia to the patient.

WARNING: Refer to the procedure "Preparation for Malignant Hyperthermia Susceptible Patients" on page F-1 before applying A5 to malignant hyperthermia susceptible patients.

Each day before administering anesthesia, the following should be done:

1. With the anesthesia machine connected to AC Power, turn the Mains switch to ON and verify that the unit is operating on AC. Follow the on-screen prompts to perform and complete the automatic machine start-up tests.
2.
 - a. Check the O₂ Supply fail-safe message and alarm.
(See "O₂ Pipeline Test" on page 4-18.)
 - b. Test low O₂ concentration alarm.
(See "Test the O₂ Concentration Monitoring and Alarms" on page 4-26.)
 - c. Test high and low airway pressure alarms.
(See "Test the High Paw Alarm" on page 4-28.)
(See "Test the Low Paw Alarm" on page 4-28.)
 - d. Test low minute volume and apnea alarms.
(See "Test the Low Minute Volume (MV) Alarm" on page 4-27.)
(See "Test the Apnea Alarm" on page 4-27.)
3. Verify that the O₂ sensor displays approximately 21% in room air and above 94% after exposure to 100% O₂ (see "Test the O₂ Concentration Monitoring and Alarms" on page 4-26).

4. Check that the vaporizers are properly installed and sufficiently filled and that filler ports are tightly closed. Verify that only one vaporizer turns ON at a time (see "Install the Vaporizer" on page 2-5).
5. Perform a 40 cmH₂O manual leak test. If present, set the left vaporizer to ON and perform a 40 cmH₂O manual leak test. Set the vaporizer to OFF. Repeat for the right vaporizer if installed (see "Manual Leak Test" on page 4-22).
6. Perform a vaporizer leak test for each vaporizer installed on the A5/A3 system (see "Vaporizer Leak Test" on page 4-22).
7. Check that AGSS float moves freely. Set the vacuum flow so that the float position is between the Min and Max lines (see "Inspect the Active AGSS" on page 4-29).
8. Drain any moisture from the breathing system water trap and the condensation drain valve at the bottom of the absorber canister assembly.

Prior to each patient, before administering anesthesia, the following should be done:

1. Inspect the A5/A3 for damage or hazardous conditions; ensure all necessary equipment and supplies are present, e.g., drugs, CO₂ absorbent (not exhausted), breathing circuits and tank wrench.
2. Check that central supply O₂, N₂O and Air pressures are each within the pipeline input range specifications (i.e., 40 to 87 psi).
3. Check that O₂, N₂O and Air flowmeters operate properly: Check that all flow levels on the monitor screen are at zero flow with flow-control valves closed. Adjust flow of all gases through their full ranges and check for erratic movements of the gas levels.
4. Check that a hypoxic mixture of less than 21% O₂ may not be administered: Attempt to create a hypoxic O₂/ N₂O mixture by slowly opening the N₂O flow control valve fully with the O₂ flow valve fully closed (no N₂O gas should be flowing). Then, slowly open the O₂ flow valve and observe O₂ and N₂O rise in proportion to maintain a minimum concentration of 21% O₂ in fresh gas.
5. Perform a vaporizer leak test for each vaporizer installed on the A5/A3 system (see "Vaporizer Leak Test" on page 4-22).
6. Verify that Auxiliary O₂ and Air are available and functioning.
7. Verify that a Self-inflating Manual Ventilation device is available and functioning.
8. Check that the O₂, N₂O, and Air cylinders (if present) are mounted on the A5/A3, have adequate pressure, and no high pressure leaks are present (see "Cylinder Tests" on page 4-20).
9. Check that valves on the O₂, N₂O, and Air cylinders (if present) are closed until needed to prevent unintentional use of gas.
10. With a breathing circuit and reservoir bag attached, check that the unidirectional valves operate by visual inspection.
11. Check ventilation capability in Standby, Manual, VCV and PCV ventilator modes.
12. Check that patient suction is adequate to clear the airway.
13. Verify ability of required monitors and check alarms.

The following step is recommended to be performed when prompted by the machine:

- Complete the 21% O₂ Calibration (see "O₂ Sensor Calibration" on page 7-6).

The following step is recommended when replacing an O₂ sensor:

- Complete the 21% and 100% O₂ Calibration (see “O₂ Sensor Calibration” on page 7-6).

The following step is recommended to be performed weekly, whenever a new vaporizer is installed or when CO₂ absorbent is replaced:

- Perform a vaporizer leak test (see “Vaporizer Leak Test” on page 4-22).

4.4 System Self-Test

When the A5/A3 is powered on, it performs a self-test to ensure its alarm system (alarm LED, speaker, and buzzer) and hardware (flowmeter board, ventilator board, assistant ventilator board, power board, and CPU board) are properly functioning.

Perform a System Self-test:

1. Turn the system switch on the front panel to the **ON** position. The A5/A3 powers up and begins its system self-test. See TABLE 4-1 for the system self-test sequence.

After the system self-test is completed, the test results are displayed on the screen. Startup alarm messages also may be displayed.

See TABLE 4-2 for a list of possible test result conditions.

See “Startup Alarm Messages” on page 6-18 for a list of Startup Alarm Messages.

2. Proceed to operate or troubleshoot the A5/A3 based on the self-test results.

SYSTEM SELF-TEST SEQUENCE		COMMENTS
1.	A high-pitched beep is sounded.	Alarm self-test
2.	The A5/A3 startup screen is displayed.	
3.	The LED above the touchscreen illuminates in sequence: red, yellow, and blue.	Alarm self-test
4.	A test low priority alarm is sounded.	Alarm self-test
5.	The System Self-Test progress bar is displayed.	
6.	The System Self-Test is automatically started.	Hardware self-test
7.	The results of the System Self-Test are displayed.	

TABLE 4-1 A5/A3 System Self-Test Sequence



RESULT	COMMENTS/OPTIONS
<p>Pass condition Example:</p> 	<p>The Pass condition indicates that the A5/A3 has passed the System Self-Test. No errors have been detected. Alarms and hardware are functioning properly.</p> <p>Select Continue to enter the Automatic Circuit Leak and Compliance Test screen. or Select Skip to enter the Standby with automatic ventilation enabled.</p>
<p>All-Functional error condition Example:</p> 	<p>The All-Functional error condition indicates that errors have been detected. However, all automatic ventilation, manual, and bypass modes are still enabled.</p> <p>Select Accept to enter the Automatic Circuit Leak and Compliance Test screen. or Select Skip to enter the main screen with automatic ventilation enabled,</p>
<p>Manual Only error condition Example:</p> 	<p>The Manual Only error condition indicates that the A5/A3 can be used in manual mode only.</p> <p>Select Retry to repeat the System Self-Test. or Select Manual Only to place the device in manual ventilation mode only. The following low priority alarm will be displayed on the main screen: Automatic Ventilation Disabled.</p>  <p>WARNING: Selecting the “Manual Only” button will disable automatic ventilation.</p>

TABLE 4-2 Types of System Self-Test Results

RESULT	COMMENTS/OPTIONS
Machine Non-Functional error condition Example:	The Machine Non-Functional error condition indicates that the A5/A3 cannot be used.
 <p>System Self Test Complete</p> <p>MACHINE NON-FUNCTIONAL</p> <p>Bundle Version: 01.00.01 Flowmeter Self Test: Fail PEEP Valve: Fail Power Supply Voltage: Fail</p> <p>Select "Retry" to repeat System Self Test -or- Contact service</p>	Select Retry to repeat the System Self-Test. or Contact service if this error condition persists. NOTE: The Service Access button is only available to Mindray-authorized service personnel and requires a service password.

TABLE 4-2 Types of System Self-Test Results

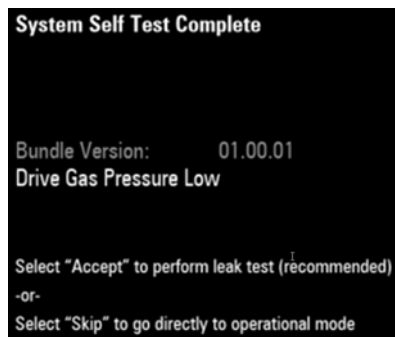
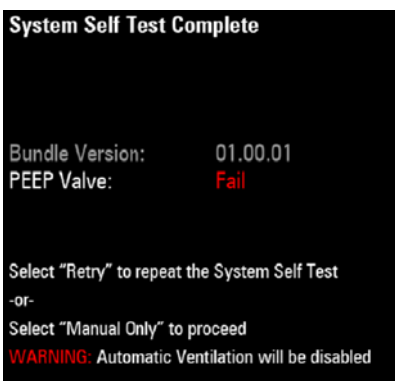
Bundle Version – The Bundle Version is displayed in all System Self-Test results. The Bundle Version is the version number of the package of software that is installed in the A5/A3. If the Bundle Version displays a fail status, contact Mindray Technical Support.

4.5 Leak and Compliance Tests

4.5.1 Automatic Circuit Leak and Compliance Test

The Automatic Circuit Leak Test screen is displayed in FIGURE 4-1.

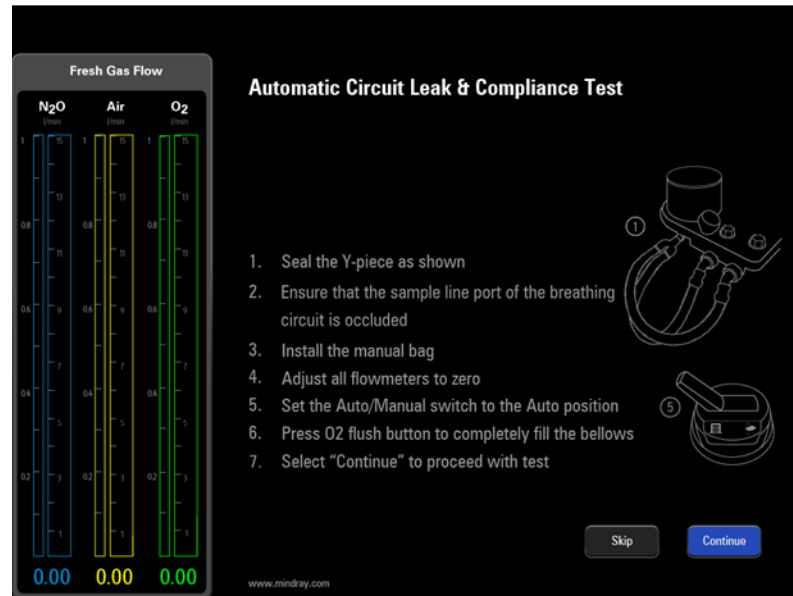

FIGURE 4-1 Automatic Circuit Leak Test

To Perform an Automatic Circuit Leak Test:

NOTE: The A5/A3 system records the result of the last Automatic Circuit Leak Test in the General tab, including if the test had passed, failed, or was skipped. To access this information, from the main screen, select the Setup softkey > General tab.

NOTE: If fresh gas is detected by the system before proceeding with the Automatic Circuit Leak & Compliance Test, a message is displayed on the screen to adjust all flowmeters to zero.

1. From power up:

If the A5/A3 System is being powered on, the system automatically initiates a self-test and enters the **Preoperative Check List** screen. Select **Continue** to enter the **Automatic Circuit Leak Test** screen, followed by the **Manual Circuit Leak Test** screen. If the **Skip** button is selected, the system bypasses the **Automatic Circuit Leak Test** and the **Manual Circuit Leak Test** and enters the Standby screen.

or

From the main screen:

Select the **Setup** softkey > **General** tab > **Test Leak/Compliance** button.

2. Follow the instructions on the screen:

1. Seal the Y-piece:

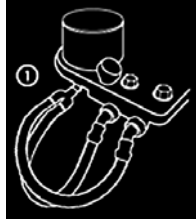

2. Ensure that the sample line port of the breathing circuit is occluded.

3. Install the manual bag.

4. Adjust all flowmeters to zero.

5. Set the **Auto/Manual** switch to the **Auto** position:6. Press the **O₂** flush button to completely fill the bellows.7. Select **Continue** to proceed with the **Automatic Circuit Leak Test**.

NOTE: The “Continue” button can be selected only when the Auto/Manual switch is set to the Auto position and when no fresh gas is detected.

3. Compare the test results with the information in TABLE 4-3, “Automatic Circuit Leak and Compliance Test Results,” on page 4-11, and proceed accordingly.

RESULTS	COMMENTS/OPTIONS
Automatic Circuit Leakage: Pass Compliance Test: XX.X mL/cmH₂O Example:	Leak rate ≤ 200 ml/min Compliance test results are displayed in green.
 <p>Automatic Circuit Leak & Compliance Test Complete</p> <p>Automatic Circuit Leakage: Pass Compliance Test: XX.X mL/cmH₂O</p> <p>Select "Continue" to proceed</p>	Select Continue to proceed to the Manual Circuit Leak Test screen.
Automatic Circuit Leakage: Pass Compliance Test: Fail Example:	Leak rate ≤ 200 ml/min Compliance test failed.
 <p>Automatic Circuit Leak & Compliance Test Complete</p> <p>Automatic Circuit Leakage: Pass Compliance Test: Fail</p> <p>Select "Retry" to repeat the test -or- Select "Accept" to proceed using previous compliance values (3.1mL/cmH₂O on 11/17/2011)</p>	The results screen displays the compliance values and time of the last compliance test that passed. If the compliance test has never been performed successfully, the compliance values and test time are displayed as ---. Select Accept to proceed to the Manual Circuit Leak Test screen and use the previous compliance values. or Select Retry to repeat the Automatic Circuit Leak Test & Compliance Test.
Automatic Circuit Leakage: XXX ml/min Compliance Test: Fail Example:	Leak rate > 200 ml/min and ≤ 1000 ml/min
 <p>Automatic Circuit Leak & Compliance Test Complete</p> <p>Automatic Circuit Leakage: 230 mL/min Compliance Test: Fail</p> <p>Check the following and select "Retry" to repeat the test (recommended):</p> <ol style="list-style-type: none"> 1. Is the condensate drain closed? 2. Is sample port plugged? <p>-or- Select "Accept" to proceed using previous compliance values (3.1 mL/cmH₂O on 11/17/2011)</p>	The results screen displays the compliance values and time of the last compliance test that passed. If the compliance test has never been performed successfully, the compliance values and test time are displayed as ---. Select Accept to proceed to the Manual Circuit Leak Test screen and use the previous compliance values. or Select Retry to repeat the Automatic Circuit Leak Test & Compliance Test.

TABLE 4-3 Automatic Circuit Leak and Compliance Test Results



RESULTS	COMMENTS/OPTIONS
<p>Automatic Circuit Leakage: Fail: Fresh gas flow detected Compliance Test: Fail Example:</p> 	<p>Fresh gas is detected. Approximate threshold for fresh gas detection is 0.15 L/min of gas flow.</p> <p>Adjust all flowmeters to zero. Select Retry to repeat the test.</p>
<p>Automatic Circuit Leakage: Fail Compliance Test: Fail Example:</p> 	<p>Leak rate >1000 ml/min. Fresh gas is not detected.</p> <p>Follow on-screen instructions to troubleshoot the problem. or Select Manual Only to place the device in manual ventilation mode only. The following low priority alarm will be displayed on the main screen: Auto Ventilation Disabled – Leak Test Failed:</p>  <p>WARNING: Selecting the “Manual Only” button will disable automatic ventilation.</p>

TABLE 4-3 Automatic Circuit Leak and Compliance Test Results

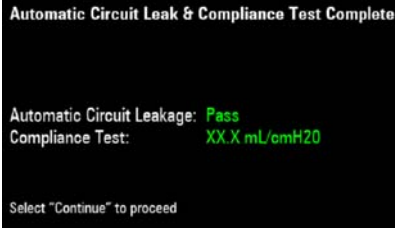
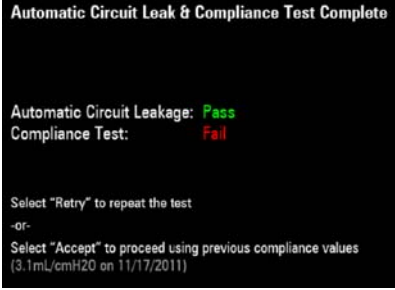
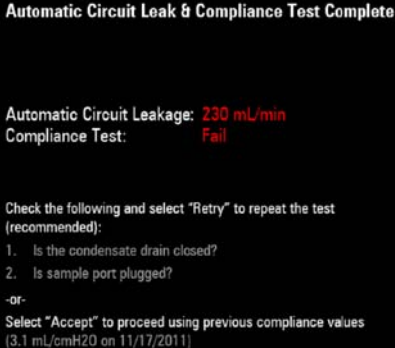
RESULTS	COMMENTS/OPTIONS
<p>MACHINE NON-FUNCTIONAL</p> <p>Automatic Circuit Leakage: Pass Compliance Test: XX.X mL/cmH₂O Safety Valve Control: Fail Example:</p> 	<p>Safety valve control test or pressure verification test failed.</p> <p>Select Retry to repeat the Automatic Circuit Leak Test & Compliance Test. or Contact service if this error condition persists.</p> <p>NOTE: The Service Access button is only available to Mindray-authorized service personnel and requires a service password.</p>
<p>Time out Example:</p> 	<p>Test result cannot be shown due to an internal communication error.</p> <p>Select Retry to repeat the Automatic Circuit Leak Test & Compliance Test. or Select Override to skip the test.</p>

TABLE 4-3 Automatic Circuit Leak and Compliance Test Results

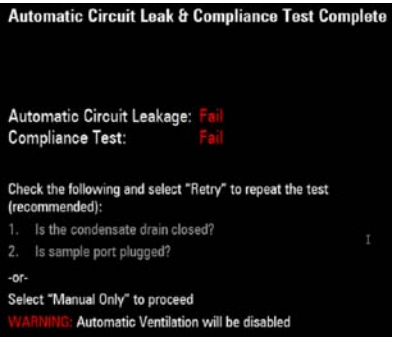
4.5.2 Manual Circuit Leak Test

The Manual Circuit Leak Test screen is displayed in FIGURE 4-2:

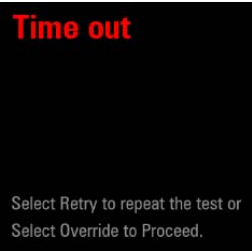
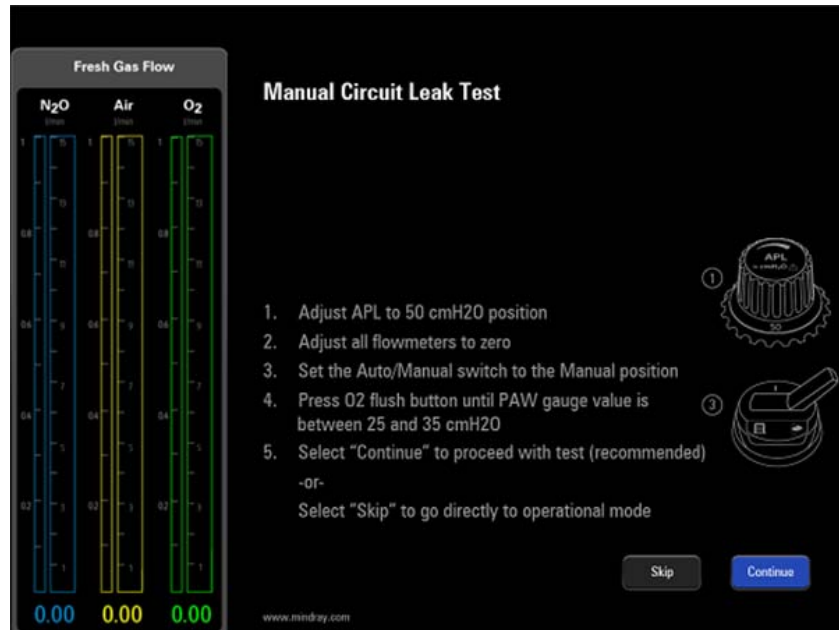

FIGURE 4-2 Manual Circuit Leak Test screen

To Perform a Manual Circuit Leak Test:

NOTE: If fresh gas is detected by the system before proceeding with the **Manual Circuit Leak Test**, a message is displayed on the screen to adjust all flowmeters to zero.

1. *From power up:*
If the A5/A3 System is being powered on, the system automatically initiates a self-test and enters the **Preoperative Check List** screen. Select **Continue** to enter the **Automatic Circuit Leak and Compliance Test** and the **Manual Circuit Leak Test**. If the **Skip** button is selected, the system bypasses these tests and enters the Standby screen.

or

From the main screen:

Select the **Setup** softkey > **General** tab > **Test Leak/Compliance** button.

2. Follow the instructions on the screen:
 1. Adjust the **APL** to the 50 cmH₂O position.
 2. Adjust all flowmeters to zero.
 3. Set the **Auto/Manual** switch to **Manual**.
 4. Press the **O₂** flush button until the PAW gauge value is between 25 and 35 cmH₂O.
 5. Select "Continue" to proceed with the **Manual Circuit Leak Test**.

or

Select "**Skip**" to go directly to operational mode.

NOTE: The "**Continue**" button can be selected only when the Auto/Manual switch is set to the Manual position and when no fresh gas is detected.

3. Compare the test results with the information in TABLE 4-4, "Manual Circuit Leak Test Results," on page 4-15, and proceed accordingly.



RESULTS	COMMENTS/OPTIONS
<p>Pass Example:</p> 	<p>Manual Circuit Leak Test passed.</p> <p>Adjust the APL valve to SP position. Select Continue to proceed to the main screen.</p>
<p>Fail: Fresh gas flow detected Example:</p> 	<p>Manual Circuit Leak Test failed. Fresh gas is detected.</p> <p>Adjust all flowmeters to zero. Select Retry to repeat the test.</p>

TABLE 4-4 Manual Circuit Leak Test Results

RESULTS	COMMENTS/OPTIONS
<p>Fail Example:</p>  <p>Manual Circuit Leak Test Complete</p> <p>Fail</p> <p>Check the following and select "Retry" to repeat the test (recommended):</p> <ol style="list-style-type: none"> 1. Is the condensate drain closed? 2. Is the sample port plugged? <p>-or-</p> <p>Adjust APL valve to SP position as shown and select "Accept" to proceed</p>	<p>Manual Circuit Leak Test failed. Fresh gas is not detected.</p> <p>Follow on-screen instructions to troubleshoot the problem. or Adjust APL valve to SP position and select Accept to proceed to the main screen.</p>
<p>Time out Example:</p>  <p>Manual Circuit Leak Test Complete</p> <p>Time out</p> <p>Check the following and select "Retry" to repeat the test (recommended):</p> <ol style="list-style-type: none"> 1. Is the condensate drain closed? 2. Is the sample port plugged? <p>-or-</p> <p>Adjust APL valve to SP position as shown and select "Accept" to proceed</p>	<p>Test result cannot be shown due to an internal communication error.</p> <p>Select Retry to repeat the Automatic Circuit Leak Test & Compliance Test. In certain rare instances, after pressing "Retry" the manual circuit leak test will be performed, but the progress bar will be blank and will not show that the manual leak test was completed. If this anomaly occurs, press the Cancel button on the screen to continue. or Select Accept to proceed.</p>

TABLE 4-4 Manual Circuit Leak Test Results

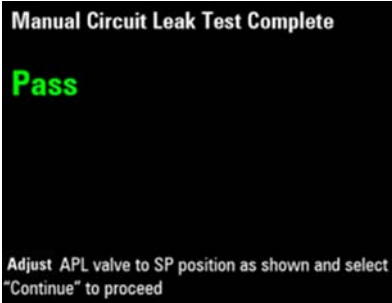
4.6 Preoperative Check List (software bundle version 02.09.00 and later)

While powering on the A5, the system automatically initiates a self-test and enters the **Preoperative Check List** screen. Select **Continue** to proceed to Standby mode. The **Preoperative Check List** screen is displayed in FIGURE 4-3.

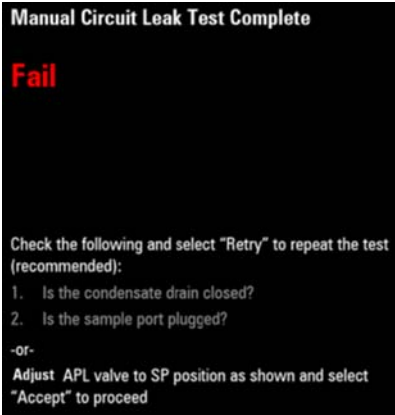
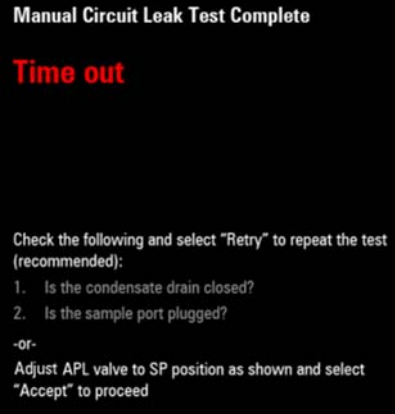
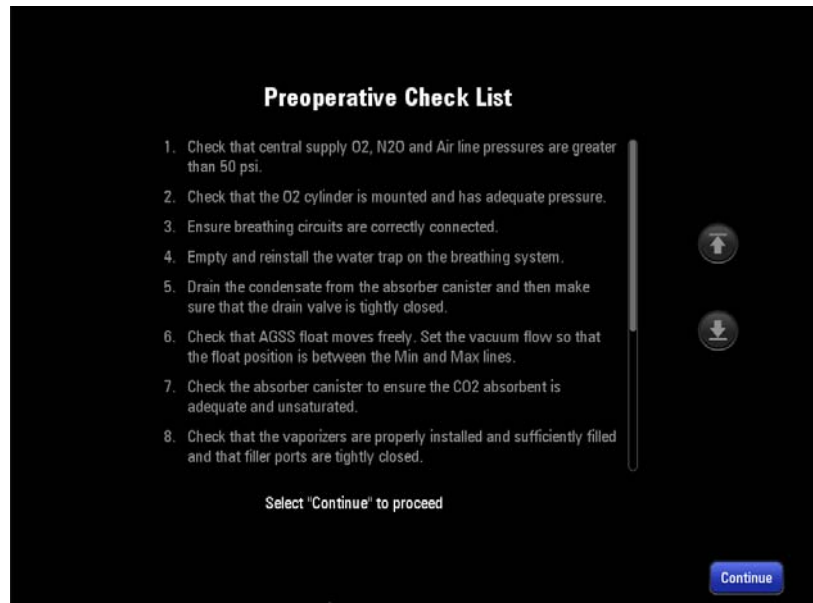

FIGURE 4-3 Preoperative Check List

4.7 Power Failure Alarm Test

1. Set the system switch to the **ON** position.
2. Disconnect the AC mains.
3. Ensure that the AC mains indicator and battery charge indicator are extinguished. An audible alarm should sound and the prompt message "**Battery in Use**" should be displayed on the main screen.
4. Reconnect the AC mains.
5. Ensure that the AC mains indicator and battery charge indicator are illuminated. The prompt message "**Battery in Use**" should not be displayed on the main screen.
6. Set the system switch to the **OFF** position.

4.8 Pipeline Tests

NOTE: If the pipeline supply is unavailable, please use the cylinder.

4.8.1 O₂ Pipeline Test

1. Connect the O₂ pipeline supply.
2. Close all cylinder valves if the A5/A3 anesthesia machine is equipped with cylinders.
3. Set the system switch to the **ON** position.
4. Set the flow controls approximately to mid-range (approximately 6 L/min).
5. Ensure that the O₂ pipeline pressure gauges show 280 to 600 kPa (40 to 87 psi).
6. Disconnect the O₂ pipeline supply.
7. As O₂ pressure decreases, alarms for "O₂ Supply Failure" and "Drive Gas Pressure Low" should occur.
8. Ensure that the O₂ gauge decreases to zero.

4.8.2 N₂O Pipeline Test

NOTE: When doing the N₂O pipeline test, connect the O₂ supply first to enable N₂O flow control.

NOTE: Different from O₂ pipeline supply, when N₂O supply is disconnected, no alarms related to N₂O pressure occur as N₂O pressure decreases.

1. Connect the O₂ and N₂O pipeline supplies.
2. Close all cylinder valves if the A5/A3 anesthesia machine is equipped with cylinders.
3. Set the system switch to the **ON** position.
4. Set the flow controls approximately to mid-range (approximately 6 L/min).
5. Check that the N₂O pipeline pressure gauges show 280 to 600 kPa (40 to 87 psi).
6. Disconnect the N₂O pipeline supply. Ensure that the N₂O gauge decreases to zero.

4.8.3 Air Pipeline Test

NOTE: Different from the O₂ pipeline supply, when the air pipeline supply is disconnected, no alarms related to Air pressure occur as Air pressure decreases.

1. Connect the Air pipeline supply.
2. Close all cylinder valves if the A5/A3 anesthesia machine is equipped with cylinders.
3. Set the system switch to the **ON** position.
4. Set the flow controls approximately to mid-range (approximately 6 L/min).
5. Check that the Air pipeline pressure gauges show 280 to 600 kPa (40 to 87 psi).
6. Disconnect the Air pipeline supply.
7. Ensure that the Air gauge decreases to zero.

4.9 Basic Ventilation Testing

- a. Attach a breathing circuit and breathing bag.
- b. Attach an adult test lung or breathing bag to the patient end of the Y-fitting of the breathing circuit.
- c. Set the O₂ flow to 3 L/min and set the N₂O and AIR flow rates to zero flow.
- d. Set the ventilator controls to:

VENTILATOR CONTROLS	VENTILATOR SETTINGS
Patient Type	Adult
Ventilation Mode	PCV
Tidal Volume Guarantee - VtG	Off
Target Pressure - P_{INSP}	20
Breath Rate - freq	8
I:E Ratio - I:E	1:2
PEEP - PEEP	Off
Inspiratory Slope - T_{slope}	0.5

- e. Select **PCV** and begin ventilation.
- f. Verify that the breathing bag at the patient end of the Y-fitting of the breathing circuit inflates and deflates and that the PLAT on the display and the PAW gauge are consistent with the P_{target} setting.

4.10 Cylinder Tests

NOTE: You do not need to perform cylinder tests if the A5/A3 anesthesia machine is not equipped with cylinders.

4.10.1 Check the Cylinder Pressure

1. Set the system switch to the **OFF** position and connect the cylinders to be checked.
2. Open each cylinder valve using the supplied wrench.
3. Ensure that each cylinder has sufficient pressure. If not, close the applicable cylinder valve and install a full cylinder.
O₂ cylinder input range: 6.9 to 15.5 MPa (1000 - 2250 psi)
N₂O cylinder input range: 4.2 to 6 MPa (600 - 870 psi)
Air cylinder input range: 6.9 to 15.5 MPa (1000 - 2250 psi)
4. Close all cylinder valves.

4.10.2 O₂ Cylinder High Pressure Leak Test

1. Set the system switch to the **OFF** position and disconnect the O₂ pipeline supply.
2. Turn off the O₂ flowmeter.
3. Open the O₂ cylinder valve.
4. Record the current cylinder pressure.
5. Close the O₂ cylinder valve.
6. Record the cylinder pressure after one minute.
If the cylinder pressure decreases more than 1.25 MPa (181 psi), install a new cylinder gasket.
Repeat steps 1 through 6. If the leak continues, do not use the cylinder supply system.

4.10.3 N₂O Cylinder High Pressure Leak Test

1. Set the system switch to the **OFF** position and disconnect the N₂O pipeline supply.
2. Turn off the N₂O flowmeter.
3. Open the N₂O cylinder valve.
4. Record the current cylinder pressure.
5. Close the N₂O cylinder valve.
6. Record the cylinder pressure after one minute.
If the cylinder pressure decreases more than 0.5 MPa (73 psi), install a new cylinder gasket.
Repeat steps 1 through 6. If the leak continues, do not use the cylinder supply system.

4.10.4 Air Cylinder High Pressure Leak Test

1. Set the system switch to the **OFF** position and disconnect the Air pipeline supply.
2. Turn off the Air flowmeter.
3. Open the Air cylinder valve.
4. Record the current cylinder pressure.
5. Close the Air cylinder valve.
6. Record the cylinder pressure after one minute.
If the cylinder pressure decreases more than 1.25 MPa (181 psi), install a new cylinder gasket.
Repeat steps 1 through 6. If the leak continues, do not use the cylinder supply system.

4.11 Flow Control System Test

WARNING: If N₂O is available and flows through the system during this test, use a safe and approved procedure to collect and remove N₂O gas.

WARNING: Incorrect gas mixtures can cause patient injury. If the O₂:N₂O ratio system does not supply O₂ and N₂O in the correct proportions, do not use the system.

CAUTION: Slowly open the cylinder valves to avoid damage. Do not use excessive force on the flow controls. After performing the cylinder tests, close all cylinder valves if cylinder supplies are not used.

CAUTION: Turn the flow controls slowly. To avoid damaging the control valves, do not turn further when the flowmeter reading is outside the range. When turning a flow control knob clockwise to decrease flow, the flowmeter should reach zero before the knob reaches its most clockwise mechanical stop (Off) position. Do not turn any further when the knob has reached the Off position.

Similarly, when turning a flow control knob counterclockwise to increase flow from zero, the flowmeter reading should not indicate a change from zero until the flow control knob is turned approximately one (1) rotation counterclockwise from the Off position, and only if permitted according to the gas ratio control system.

To perform the flow control system tests:

1. Connect the pipeline supplies or slowly open the cylinder valves.
2. Turn all flow controls fully clockwise (flow OFF).
3. Set the system switch to the **ON** position.
4. Do not use the system if the low battery alarm or other ventilator failure alarms occur.
5. Test the O₂: N₂O ratio system with change of O₂ flow:
Turn the O₂ and N₂O flow controls fully clockwise (flow OFF). Then, turn the N₂O flow control fully counterclockwise (open position). There should be no N₂O flow since there is no O₂ flow yet. Turn the O₂ control to the values shown in the table below. The N₂O value should meet the criteria shown in the table.

STEP	O ₂ FLOW SETTING (L/MIN)	N ₂ O FLOW (L/MIN)
1	0	0
2	0.3	≤ 1.0
3	0.8	≥ 2.0 and ≤ 2.5
4	1.0	≥ 2.5 and ≤ 3.2
5	2.0	≥ 4.90 and ≤ 6.3
6	3.0	≥ 7.4 and ≤ 9.5
7	4.0	≤ 12.7
8	5.0	≤ 15.8
9	6.0	≤ 19.0
10	0	0

4.12 Vaporizer Tests

WARNING: During the vaporizer tests, the anesthetic agent exits from the fresh gas outlet. Use a safe and approved procedure to remove and collect the agent.

WARNING: To prevent damage, turn the flow controls fully clockwise (flow OFF) before using the system.

Before the test, ensure that the vaporizers are correctly installed. For details about vaporizer installation, see "Install the Vaporizer" on page 2-5.

4.12.1 Vaporizer Back Pressure Test

1. Connect the O₂ pipeline supply or open the O₂ cylinder valve.
2. Set the O₂ flow to 6 L/min.
3. Ensure that the O₂ flow stays constant.
4. Adjust the vaporizer concentration from 0 to 1%. Ensure that the O₂ flow must not decrease more than 1 L/min through the full range. Otherwise, install a different vaporizer and repeat this step. If the problem persists, the malfunction is in the anesthesia system. Do not use this system.
5. Test each vaporizer as per the steps above.

NOTE: Do not perform this test on the vaporizer when the concentration control is between "OFF" and the first graduation above "0" (zero) as the amount of anesthetic drug outputted is very small within this range.

4.12.2 Manual Leak Test

1. Set the **Auto/Manual** ventilation switch to **Manual**.
2. Connect a breathing circuit to the inspiratory and expiratory ports. Connect a ventilation bag to the bag arm.
3. Set APL Valve to 75 cmH₂O.
4. Close the breathing system at the patient connection by connecting the Y-piece on the breathing circuit to the leak test port.
5. Inflate the ventilation bag with O₂ flush to 40 cmH₂O.
6. Verify that circuit holds pressure for greater than 10 seconds.
7. Set the APL valve to SP.

4.12.3 Vaporizer Leak Test

1. Set the **Auto/Manual** ventilation switch to **Manual**.
2. Set the APL valve to the **SP** position.

3. Connect one end of the breathing circuit to the bag arm, one end to the inspiratory port and the Y-piece to the test port:



4. Mount and lock the vaporizer onto the vaporizer mount. (Certain vaporizers need to be set to at least 1% for correct testing. See the vaporizer manufacturer's manual for details.)
5. Set the fresh gas flow to 200 ml/min.
6. Set the APL valve to 75 and verify that the pressure on the airway pressure gauge increases above 30 cmH₂O within 2 minutes.
7. Turn off the vaporizer.
8. Repeat Steps 4, 5, 6, and 7 for the other vaporizer.

4.13 Breathing System Tests

WARNING: Objects in the breathing system can stop gas flow to the patient. This can cause injury or death. Ensure that there are no test plugs or other objects in the breathing system.

WARNING: Do not use a test plug that is small enough to fall into the breathing system.

1. Ensure that the breathing system is correctly connected and not damaged.
2. Ensure that the check valves in the breathing system work correctly:
 - a. The inspiratory check valve opens during inspiration and closes at the start of expiration.
 - b. The expiratory check valve opens during expiration and closes at the start of inspiration.

4.13.1 Bellows Test

1. Select the **End Case** button in the **Manual** tab.
2. Follow the screen prompts to end the case and enter **Standby** mode.
3. Set the **Auto/Manual** ventilation switch to **Auto**.
4. Set all flow controls to Off.
5. Close the breathing system at the patient connection by connecting the Y-piece on the breathing circuit to the leak test port.
6. Push the O₂ flush button to expand the bellows to the top of the bellows enclosure.
7. Ensure that the pressure does not increase to more than 15 cmH₂O on the airway pressure gauge.
8. The bellows should not fall faster than a rate of approximately 300 ml/min. If the leak rate is greater, troubleshoot the source of the leak. If the source of the leak is the bellows, then the bellows must be replaced.

4.13.2 Breathing System Leak Test in Manual Ventilation Status

1. Set the **Auto/Manual** ventilation switch to **Manual**.
2. Adjust all flowmeters to zero.
3. Select the **End Case** button in the **Manual** tab.
4. Follow the screen prompts to end the case and enter **Standby** mode.
5. Connect the manual bag to the manual bag port.
6. Turn the APL valve control to fully close the APL valve (75 cmH₂O).
7. Turn the O₂ flow control to set the O₂ flow to 0.15 L/min.
8. Connect the Y-piece on the breathing circuit to the leak test port.
9. Push the O₂ flush button to let the pressure increase to approximately 30 cmH₂O on the airway pressure gauge.
10. Release the flush button. A pressure decrease on the airway pressure gauge indicates a leak. Contact your service personnel.

4.13.3 APL Valve Test

- 1.** Select the **End Case** button in the **Manual** tab.
- 2.** Follow the screen prompts to end the case and enter **Standby** mode.
- 3.** Set the **Auto/Manual** switch to Manual.
- 4.** Connect the manual bag to the manual bag port.
- 5.** Connect the Y-piece on the breathing circuit to the leak test port.
- 6.** Turn the APL valve control to 30 cmH₂O.
- 7.** Set the O₂ flow to 10 L/min. Turn any other gases off.
- 8.** Press the flush button until the manual bag is inflated and then release the button. Ensure that the reading on the airway pressure gauge is with the range of 25 cmH₂O to 40 cmH₂O after it is steady.
- 9.** Turn the APL valve control to the fully open position.
- 10.** Set the O₂ flow to 3 L/min. Turn any other gases off.
- 11.** Ensure that the reading on the airway pressure gauge is less than 5 cmH₂O.
- 12.** Push the O₂ flush button continuously. Ensure that the reading on the airway pressure gauge does not exceed 10 cmH₂O.
- 13.** Turn the O₂ flow control to Off. Ensure that the reading on the airway pressure gauge does not decrease below 0 cmH₂O.

4.14 Alarm Tests

Alarms also can be verified by creating an alarm condition on the A5/A3 and verifying the corresponding alarm indicators are present on the monitor.

4.14.1 Prepare for Alarm Tests

1. Connect a test lung or manual bag to the Y-piece of the breathing circuit.
2. Set the **Auto/Manual** switch to **Auto**.
3. Set the system switch to the **ON** position.
4. Set the system to **Standby** mode.
5. Set the Patient Size to Adult.
6. Set the ventilator controls as follows:
 - Ventilation mode: select VCV
 - Vt: 500 ml
 - Rate: 12 bpm
 - I:E: 1:2
 - Tpause: 10%
 - PEEP: OFF
 - Plimit: 30 cmH₂O
7. Turn the O₂ flow control to set the O₂ flow to 0.5 to 1 L/min.
8. Push the O₂ flush button to expand the bellows to the top of the bellow enclosure.
9. Touch the screen to exit **Standby** mode and begin ventilation.
10. Ensure that:
 - The main screen displays the correctly set data. The measured values should be within the tolerances specified in the specifications (see TABLE 9-28, "Control and Monitoring Accuracy," on page 9-19).
 - The bellows inflates and deflates normally during mechanical ventilation.

4.14.2 Test the O₂ Concentration Monitoring and Alarms

NOTE: For A5s with an installed gas module, disconnect the sample tube from the Y-piece and breathe into it until you see a CO₂ reading on the screen. Then reconnect the sample tube to the Y-piece. This will activate the gas module alarms.

1. Set the **Auto/Manual** switch to Manual.
2. Remove the O₂ sensor. After three minutes, ensure that the sensor measures approximately 21 % O₂ in room air by verifying the FiO₂ value on the main screen.
3. Select the **Alarms** softkey and then the **Limits** tab. Set the FiO₂ low alarm limit to 50 %.
4. Ensure that a low O₂ alarm ("FiO₂ Too Low") occurs.
5. Set the FiO₂ low alarm limit back to a value less than the measured O₂ value and ensure that the alarm cancels.
6. Put the O₂ sensor back in the breathing system.
7. Select the **Alarms** softkey and then the **Limits** tab. Set the FiO₂ high alarm limit to 50 %.

8. Connect the manual bag to the manual bag port. Push the O₂ flush button to fill the manual bag. Ensure that the sensor measures at least 90 % O₂.
9. Ensure that a high O₂ alarm ("FiO₂ Too High") occurs.
10. Set the FiO₂ high alarm limit to 100 % and ensure that the alarm cancels.

4.14.3 Test the Low Minute Volume (MV) Alarm

1. Set the **Auto/Manual** ventilation switch to **Auto**.
2. Set the ventilator controls as follows:
 - Ventilation mode: select VCV
 - Vt: 500 mL
 - Rate: 12 bpm
 - I:E: 1:2
 - Tpause: 10%
 - PEEP: OFF
 - Plimit: 30 cmH₂O
3. Select the **Alarms** softkey and then the **Limits** tab. Set the MV low alarm limit to 8.0 L/min.
4. Ensure that a low MV alarm occurs after approximately 60 seconds.
5. Select the **Alarms** softkey and then the **Limits** tab. Set the MV low alarm limit back to a value less than the measured MV value and ensure that the alarm cancels.

4.14.4 Test the Apnea Alarm

1. Connect the manual bag to the manual bag port
2. Set the **Auto/Manual** ventilation switch to **Manual**.
3. Turn the APL valve control to set the APL valve to 10 cmH₂O.
4. Inflate using the O₂ pushbutton and squeeze the manual bag to ensure that a complete breathing cycle occurs on screen.
5. Stop inflating the manual bag and wait for more than 30 seconds to ensure that the apnea alarm occurs.
6. Inflate and squeeze the manual bag to ensure that the apnea alarm cancels.

4.14.5 Test the Continuous Airway Pressure Alarm

1. Connect the manual bag to the manual bag port.
2. Turn the O₂ flow control clockwise to set the O₂ flow to Off.
3. Turn the APL valve control to set the APL valve to 30 cmH₂O position.
4. Set the **Auto/Manual** ventilation switch to **Manual**.
5. Push the O₂ flush button for approximately 15 seconds. Ensure that the Continuous Airway Pressure alarm occurs.
6. Disconnect the breathing circuit and ensure that the alarm cancels.
7. Reconnect the breathing circuit.

4.14.6 Test the High Paw Alarm

1. Set the **Auto/Manual** ventilation switch to **Auto**.
2. Select the **Alarms** softkey and then the **Limits** tab.
3. Set the PEAK low alarm limit to 0 cmH₂O and PEAK high alarm limit to 10 cmH₂O.
4. Ensure that a high Paw alarm ("Paw Too High") occurs.
5. Set the PEAK high alarm limit to 40 cmH₂O.
6. Ensure the high Paw alarm cancels.

4.14.7 Test the Low Paw Alarm

1. Set the **Auto/Manual** ventilation switch to **Auto**.
2. Select the **Alarms** softkey and then **Limits** tab.
3. Set the Peak low alarm limit to 2 cmH₂O.
4. Disconnect the test lung or manual bag from the Y-piece of the breathing circuit.
5. Wait for 20 seconds. View the alarm area and ensure that a low Paw alarm occurs.
6. Connect the test lung or manual bag to the Y-piece of the breathing circuit. If using a manual bag, squeeze the bag to cancel the alarm.
7. Ensure the low Paw alarm cancels.

4.15 Preoperative Preparations

1. Ensure that the ventilator parameters and alarm limits are set to applicable clinical levels.
2. Ensure that the system is in Standby.
3. Ensure that the equipment for airway maintenance, manual ventilation and tracheal intubation, and applicable anesthetic and emergency drugs are available.
4. Set the **Auto/Manual** ventilation switch to **Manual**.
5. Connect the manual bag to the manual bag port.
6. Turn off all vaporizers.
7. Turn the APL valve control to the SP position to fully open the APL valve.
8. Turn all flow controls to set all gas flows to Off.
9. Ensure that the breathing system is correctly connected and not damaged.

WARNING: Before connecting a patient, flush the A5/A3 anesthesia machine with 8 L/min of O₂ for at least two minutes. This removes unwanted mixtures and by-products from the system.

4.16 Inspect the Active AGSS

1. Connect the vacuum hose to the EVAC port or vacuum port of the healthcare facility and turn on the waste gas disposal system. Adjust the position of the float to be between the **MIN** and **MAX** lines by turning its flow adjustment knob (counterclockwise increases flow, clockwise decreases flow).
2. Check if the float can rise and exceed the "MIN" mark. If any blockage, tackiness, or damage occurs to the float, disassemble, clean the filter, and assemble the float again or replace the float.
3. Drain any moisture from the waste gas hose. Reconnect the waste gas hose to the active AGSS waste gas port.

NOTE: Do not block the active AGSS pressure compensation openings during the inspection. If the float cannot rise, the possible reasons are:

1. The float surface is tacky. Turn over the active AGSS and check if the float moves up and down freely.
2. The float is rising slowly. The filter may be blocked. Check if the filter is blocked.
3. The waste gas disposal system is not working or the pump rate is less than 50 L/min at which the active AGSS works normally. Check the waste gas disposal system.

NOTE: The knob on the top of the scavenger is meant to adjust the flow from the EVAC. When the knob is fully closed it does not need to completely shut off flow.

This page intentionally left blank.

Operations

Powering On the A5/A3 Anesthesia System	5-2
Powering Off the A5/A3 Anesthesia System	5-2
Patient Setup	5-3
Oxygen Sensor Calibration	5-5
Input Fresh Gas	5-6
Ventilation Modes	5-8
Start Mechanical Ventilation	5-19
Stop Mechanical Ventilation	5-19
Relationships of Ventilation Parameters	5-19
Parameter Monitoring (Numerics)	5-20

WARNING: Before using the A5/A3 Anesthesia System on the patient, ensure that the system is correctly assembled and in good condition, and that all the tests described in the Preoperative Test are already completed. In case of test failure, do not use the system. Have a qualified Mindray service representative repair the system.

5.1 Powering On the A5/A3 Anesthesia System

1. Connect the gas supplies and gas cylinders to the A5/A3.
2. Connect the power cord to the AC power source. Ensure that the AC power LED is illuminated.
3. Set the system switch to **ON**. Ensure that both the operating state LED and battery LED are illuminated (the battery is being charged or fully charged).
4. The display shows the start-up screen.
5. The alarm LED flashes red, yellow, and cyan once in turn and then a beep is given. This verifies that audible and visual alarms are operational.
6. After several seconds, the system self-test screen is displayed and the A5/A3 runs its system self-test.

5.2 Powering Off the A5/A3 Anesthesia System

The A5/A3 system provides a powering off function with the following features:

- A prompt sound is given when user turns off the A5/A3. If the system switch is turned off in Standby mode, the A5/A3 will immediately power off.
- If the system switch is turned off in Manual mode or in any of the Automatic ventilation modes, the A5/A3 will wait 12 seconds to power off completely. In the 12-second power off delay period, the screen will display a 10 second countdown timer. If the A5/A3 is performing Automatic ventilation, the ventilator will continue ventilating the patient in the current ventilation mode.
- A beep is sounded for each second of the countdown from 10 to 1 second, after which a two-second shutdown sound is given when the timer reaches zero.
- The volume of power off delay sound can be adjusted in the System Alerts setting in the Alarm Volume menu.
- When the user turns on the machine during the power off delay period, the countdown timer will disappear, and the ventilator will resume its previous state.

NOTE: The powering off function is not implemented during Standby, only when actively ventilating.

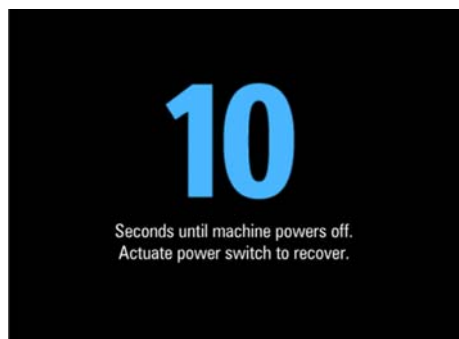

FIGURE 5-1 Countdown timer screen

5.3 Patient Setup

NOTE: Discharge button was renamed **End Case** in software bundle version 02.06.00 and later.

5.3.1 End Case / Standby Mode

The **End Case** button is located in the **Manual** tab (see FIGURE 5-2). The **End Case** button can be selected only when the **Auto/Manual** ventilation switch is set to **Manual**, and when all gas flows are turned off.



FIGURE 5-2 End Case Button

Ending the case changes the current patient size to the default patient size and loads the user defaults for the system; clears the patient demographics; clears the User Alarm Log and Spirometry Loops (including the currently plotting loop, reference loop, and baseline loop); and places the system into **Standby** mode (see FIGURE 5-4).

For software bundle version 02.02.00 or later, after the **End Case** button is selected, a warning box with a **Restore default settings** checkbox will be displayed. Selecting the **Restore default settings** checkbox reloads the user defaults, clears patient demographics, clears the history, clears the spirometry reference loops, and places the system into **Standby** mode (see FIGURE 5-4).

If the Restore Default settings checkbox is not selected, all the settings are retained.

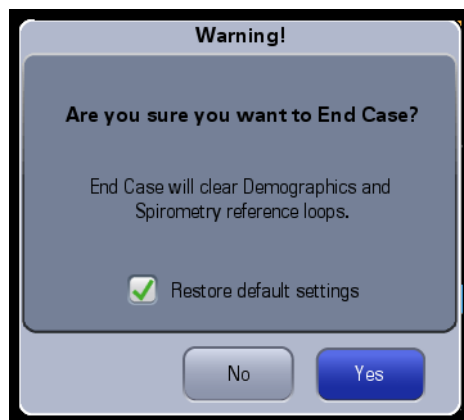

FIGURE 5-3 End Case Checkbox

In **Standby**, all system functions are on idle. It is the default system startup mode and is used after ending the case.



FIGURE 5-4 Standby Mode

To end the case and enter Standby:

1. Set the **Auto/Manual** ventilation switch to **Manual**.
2. Turn off all fresh gas flows by turning their knobs clockwise. Wait until all fresh gas flow levels are effectively at 0.0 L/min (i.e., flow < 0.05 L/min).

NOTE: The A5/A3 system will not allow the **End Case** button to be selected until the **Auto/Manual** ventilation switch is set to **Manual**, and system detects the individual fresh gas flows are effectively turned off (i.e., flow < 0.05 L/min).

3. Select the **End Case** button in the **Manual** tab (see FIGURE 5-2).
4. Follow the screen prompts to end the case and enter **Standby** mode.
5. To exit **Standby**, set the **Auto/Manual** ventilation switch to **Manual**, then touch the screen or turn on the fresh gas flow to more than 0.2 L/min of individual gas.

NOTE: To exit **Standby** by turning on the fresh gas flow, the flow must be increased to more than 0.2 L/min.

NOTE: The **End Case** button can be selected only when the system is not in **Standby**, all fresh gas flows are off, and the **Auto/Manual** switch is in the **Manual** position.

NOTE: When the system is in **Standby** mode, the **Bypass**, **Monitor** and **End Case** buttons in the **Manual** tab are disabled. However, the **Alarms** button remains enabled and can be toggled to **On** or **Off**.

WARNING: Selecting **End Case** to enter **Standby** mode will stop ventilation and parameter monitoring. Do not select **Standby** mode if the patient requires continuous ventilation.

5.3.2 Select the Patient Size (Adult, Pediatric, Infant)

Patient size can only be changed when the current ventilation mode is **Manual** mode, **Standby** mode or **Monitor** mode (available with AG module).

1. Select **Manual** mode or select the **End Case** button (in the **Manual** tab) to enter **Standby** mode.
2. Select the **Patient Size** softkey at the top left of the main screen. The softkey displays "Adult", "Pediatric", or "Infant".
3. Select the **Patient Size: Adult, Pediatric, or Infant**.
4. Select the **Accept** softkey to finalize your selection.

NOTE: The A5/A3 saves the latest patient parameter settings (VCV, PCV, PCV-VG (A5 only), PS, SIMV-VC, SIMV-PC (A5 only), and Alarms) for each patient type: Adult, Pediatric, and Infant. Changing to another patient type does not erase the parameter settings from the previous patient type. For example, changing from Adult to Pediatric and back to Adult will result in the Adult patient parameter settings still saved.

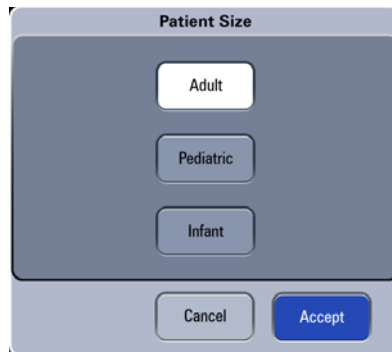

FIGURE 5-5 Patient Size Setup Menu

5.4 Oxygen Sensor Calibration

If oxygen sensor calibration is needed, please see "O2 Sensor Calibration" on page 7-6.

5.5 Input Fresh Gas

5.5.1 Set N₂O, Air, and O₂ Inputs

1. You can control the N₂O, Air, and O₂ flows in the fresh gas through the N₂O, Air, and O₂ flow controls. Readings of the gas flow can be seen on the respective electronic flowmeter on the screen. Below the electronic flowmeters and between the pressure gauges is the total flowmeter showing the total flow of the mixed gas.
 - Safety systems within the A5/A3 work to prevent hypoxic mixtures from being delivered to the patient. Nitrous oxide will not be delivered unless oxygen flow is present. A mechanical safety system assures that at least 21% O₂ is present when setting mixtures of O₂ and N₂O.
 - Ensure that both O₂ and N₂O flow controllers are turned OFF fully (clockwise) at the start and at the end of each case.
 - All A5/A3 units are designed to maintain a safe O₂:N₂O ratio by allowing nitrous oxide to be set to a flow rate that is proportional to a previously adjusted flow of oxygen. The N₂O flow is limited by the flow of O₂ so that a safe ratio of no less than 21% oxygen can be maintained.
 - When adjusting N₂O and O₂ flow rates, always adjust the oxygen flow first to enable the nitrous oxide flow. To add N₂O to the fresh gas flow, the user must open the N₂O flowmeter valve, but only after opening the O₂ flowmeter valve.

NOTE: You can adjust O₂ concentration in the breathing system through the O₂ flow control.

NOTE: The total flowmeter is calibrated based on 100% O₂. The accuracy of the flowmeter may degrade with other gas or mixed gas.

NOTE: When viewing the readings on the total flowmeter, keep your visual angle at the same level of the float. The reading of the scale may vary when viewed at a different angle.

NOTE: If the readings shown on the electronic flowmeters differ from that on the total flowmeter, the electronic flowmeter will prevail and the total flowmeter is an approximate value.

NOTE: When the AC power supply is not connected and batteries are depleted, the flow and the composition of the fresh gas are not affected. When the individual N₂O or Air supply fails, the corresponding fresh gas cannot be achieved. When O₂ supply fails, both O₂ and N₂O fresh gas cannot be achieved.

5.5.2 Set Anesthetic Agent

NOTE: You do not need to perform this operation if inspiratory anesthetic agent is not used.

NOTE: The A5/A3 anesthesia system can be mounted with vaporizers corresponding with Halothane, Enflurane, Isoflurane, Sevoflurane and Desflurane. Only one vaporizer can be opened at a time because of the interlock system.

5.5.2.1 Select the Desired Anesthetic Agent

1. Determine the anesthetic agent to be used and then fill the vaporizer.

NOTE: Install the vaporizers with a Selectatec interlock system that are compliant to ISO 80601-2-13 on the A5 unit. Refer to the vaporizer manufacturer's Instructions For Use for filling or draining the vaporizer and other information.

WARNING: Ensure that the correct anesthetic agent is used. The vaporizer is designed with the specific anesthetic agent named on it and further indicated by color coded labelling. The concentration of the anesthetic agent actually output will vary if the vaporizer is filled with the wrong agent.

2. Mount the vaporizer filled with anesthetic agent onto the A5/A3 Anesthesia System. See "Install the Vaporizer" on page 2-5.

5.5.2.2 Adjust the Concentration of Anesthetic Agent

Push and turn the concentration control on the vaporizer to set the appropriate concentration of anesthetic agent. For details about how to use the anesthetic agent, refer to the Vaporizer Instructions for Use.

5.6 Ventilation Modes

NOTE: In all ventilation modes, when inspiration pressure reaches the high alarm limit of Paw, the system switches to expiration immediately and airway pressure is released.

NOTE: When the drive gas supply fails, mechanical ventilation cannot work normally.

5.6.1 Monitored Parameters

NOTE: The monitored parameters are measured in the condition of ATPS (ambient temperature and pressure saturated).

The A5/A3 monitors the following ventilation parameters:

PARAMETER	RANGE*	COMMENTS
PEAK	-20 – 120 cmH ₂ O	
MEAN	-20 – 120 cmH ₂ O	
Vt	0 – 3000 ml	
MV	0 – 100 L	
PLAT	-20 – 120 cmH ₂ O	
Rate	0 – 120 bpm	
PEEP	0 – 70 cmH ₂ O	
FiO ₂	18 – 100%**	
I:E	—	Displayed only in SIMV-VC, SIMV-PC, and PS modes

* If the monitored parameter is out of range, it will be displayed as “- - -”.

**FiO₂ measurements between 100% and 110% inclusive will be displayed as 100%. Above this range, the system will display “- - -”.

5.6.2 Ventilation Modes

The A5/A3 provides the following ventilation modes:

VENTILATION MODE	PARAMETERS
VCV	Vt, Rate, I:E, Tpause, PEEP, Plimit
SIMV-VC	Vt, Rate, Tinsp, Tpause, PEEP, Plimit, PS (On/Off), ΔP, Trigger, Tslope,
PCV	A5: VtG, PlimVG, Pinsp, Rate, I:E, PEEP, Tslope A3: Pinsp, Rate, I:E, PEEP, Tslope
SIMV-PC (A5 only)	Pinsp, Rate, Tinsp, PS (On/Off), ΔP, Trigger, PEEP, Tslope
PS	Min Rate, ΔP, Trigger, PEEP, Tslope, Apnea Ti
Manual	Bypass (A5 only), Alarms, Monitor (available with AG module)

5.6.3 Change Ventilation Mode

To change ventilation mode to Manual

1. Use the Auto/Manual Bag switch on the breathing system block to enter and exit Manual ventilation mode.

To change ventilation mode to VCV, SIMV-VC, PCV, SIMV-PC (A5 only), or PS:

1. Select the tab of the desired ventilation mode. The “Set Mode” button (or “Preset Mode” button in manual) will flash (see FIGURE 5-6).
2. Select the “Set Mode” button (or “Preset Mode” button in manual) to confirm. If the “Set Mode” button is not selected after several seconds, an audio reminder will sound for several seconds and then the system will return to the previous ventilation mode.
3. Optionally, select each available ventilation parameter to edit the parameter setting.
4. Move the Auto/Manual Bag switch to the Auto position.

NOTE: When the Auto/Manual switch is in Auto position, all the buttons in Manual tab (Alarms, Bypass, Monitor and End Case) are disabled; Alarms are set to On; and Bypass is set to Off.



FIGURE 5-6 Ventilation Mode Tabs

5.6.4

Set Manual Ventilation Mode

Manual ventilation mode is used for manually ventilating a patient or to let a patient breathe spontaneously. To use the manual mode, the user must first set the APL valve to the desired pressure value and then use the **Auto/Manual** switch on the breathing module to enter and exit **Manual** mode. Push the **O₂** flush button to inflate the bag if necessary.

When the **Auto/Manual** switch is set to **Manual**, and the **Alarms** button in the **Manual** mode tab is set to **Off**, the alarm limit indicators on the main screen to the right of the measured values related to **Pressure** and **Volume** (such as PEAK and MV) will change to **Off** (see FIGURE 5-7).

The **Alarms** button setting (**On/Off**) in the **Manual** mode tab is saved and restored when toggling from **Manual** to **Auto** and back to **Manual** mode. For example, if the **Alarms** button is set to **Off**, this setting will be saved and restored to **Off** after switching to **Auto** and back to **Manual** mode.



FIGURE 5-7 Alarm Limit Indicators

Setting the APL Valve for Manual Ventilation

Rotate the APL valve adjustment knob to the desired pressure. The number on the rotating portion that lines up with the index mark on the bottom section of the valve indicates the approximate pressure setting.

NOTE: Clockwise rotation increases the pressure, and counterclockwise rotation decreases the pressure.

The patient can be ventilated by hand using the breathing bag. The pressure will be limited to the value set on the APL valve.

Setting the APL Valve for Spontaneous Breathing

Rotate the APL valve adjustment knob fully counterclockwise until the **SP** marking on the knob lines up with the index mark on the bottom section of the valve. The valve will then be open for spontaneous patient breathing.

NOTE: In the manual ventilation mode, you can use the APL valve to adjust the breathing system pressure limit and gas volume in the manual bag. When the pressure in the breathing system reaches the pressure limit set for the APL valve, the valve opens to release excess gas.

NOTE: The APL valve adjusts the breathing system pressure limit during manual ventilation. Its scale shows approximate pressure.

Cardiac Bypass Mode (A5 Only)

Cardiac Bypass mode is only available in **Manual** ventilation mode. This mode turns off pressure volume and apnea alarms when they are not appropriate (e.g., during heart/lung bypass).

NOTE: When Bypass mode is On, the Alarms button is disabled and set to Off.

A confirmation dialogue appears when turning Bypass mode On or Off.

Enter **Cardiac Bypass** mode by setting the **Bypass** softkey in **Manual** mode to **On**. When the **Bypass** softkey is set to **On**, the **Alarm** softkey is disabled and set to **Off** automatically. When **Bypass** is set to **Off**, the **Alarm** button returns to its setting before entering **Bypass**. When exiting Manual mode or discharging a patient, Bypass will be set to Off.

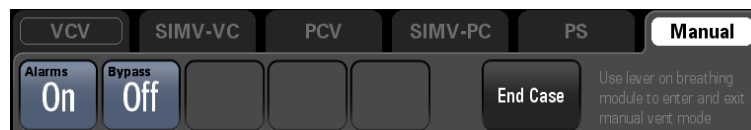

FIGURE 5-8 Bypass Mode Softkey

5.6.5 Setting Monitor Mode (A5 with AG Module connected)

Monitor mode is only available in the Manual ventilation mode when there is an AG module connected to the A5. This mode turns off all ventilation related alarms.

NOTE: When Monitor mode is On, the Alarms button is disabled and set to Off.

A confirmation dialog displays when turning Monitor mode On or Off.

Enter the Monitor mode by setting the Monitor softkey in **Manual** mode to On. When the Monitor softkey is set to On, the Alarm softkey is disabled and set to Off automatically. When Monitor is set to Off, the Alarm button restores to its settings before entering the Monitor mode. When exiting Manual mode or discharging a patient, Monitor will be set to Off.

When the system is working in **Monitor** mode, the flow, volume and pressure waveforms and measured values are removed from the Waveforms tab. Only the CO2 waveform and the CO2 parameters will remain on the Waveforms tab. The Rate as determined by the AG module is displayed in the measured values area.

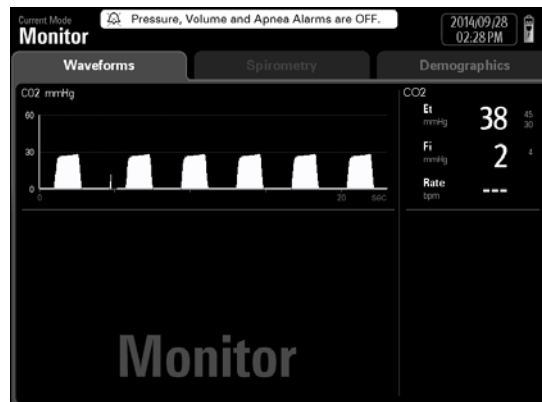

FIGURE 5-9 Monitor Mode

Setting Alarms

In **Manual** ventilation mode, when **Bypass** and **Monitor** are set to **Off**, the pressure, volume and apnea alarms can be turned off by setting the **Alarms** softkey to **Off**. The related alarm limits are then displayed as **Off**.

Pressure, volume and apnea alarms can be turned on by setting the **Alarms** softkey to **On**, which returns the related alarm limits to their original settings.

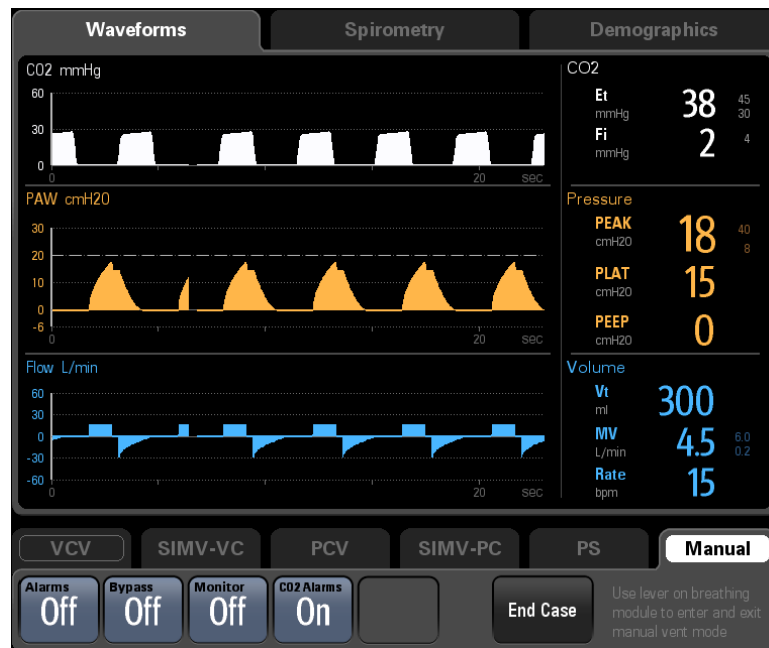

FIGURE 5-10 Set Alarms to Off

Setting CO₂ Alarms (software bundle version 02.04.00 and later)

In manual ventilation mode, the CO₂ and the CO₂ apnea alarms can be turned off by setting the **CO₂ Alarms** softkey to **Off**. The related alarm limits are then displayed as **Off** and the **CO₂ and the CO₂ Apnea Alarms are Off** prompt will be displayed in the alarm area.

The CO₂ and the CO₂ apnea alarms can be turned on by setting the **CO₂ Alarms** softkey to **On** or by switching to mechanical ventilation mode which returns the related alarm limits to their original settings.

NOTE: In mechanical ventilation mode, the CO₂ alarms are turned on and cannot be turned off.

When the system exits standby mode and the **CO₂ Alarms** softkey is **On**, the system will not activate the CO₂ and the CO₂ apnea alarms until three continuous CO₂ waves are monitored.

The CO₂ and the CO₂ apnea alarms are disabled for 30 seconds when the ventilation mode is switched from **Manual** to **Auto** or when the **CO₂ Alarms** softkey is set from **Off** to **On**. After 30 seconds, the CO₂ and the CO₂ apnea alarms would be enabled even if CO₂ has not been detected.

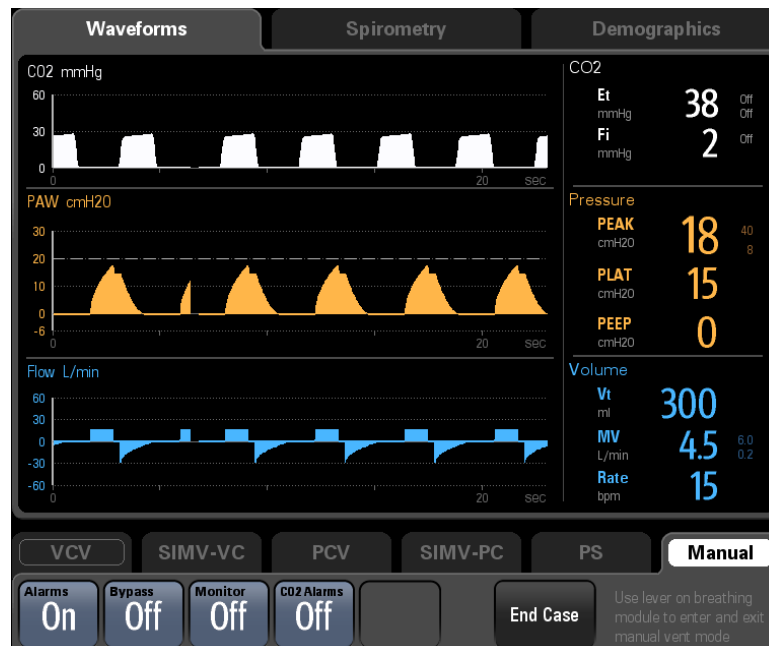

FIGURE 5-11 Set CO₂ Alarms to Off

WARNING: Risk of inadequate monitoring. National standards require a minimum monitoring with some alarm functions. These standards may not be met if the alarm function of the CO₂ monitoring parameter is disabled. Only disable this monitoring parameter after consulting national standards.

5.6.6 Make Settings before Starting Mechanical Ventilation Mode

1. Set the **Auto/Manual** ventilation switch to **Manual**. If discharging a patient, select the **End Case** button in the **Manual** tab to enter **Standby** mode.
2. Select the desired ventilation mode tab.
3. Set the desired ventilation parameters.
4. Select the **Preset** button (flashing green) on the right of the ventilation tabs to confirm the ventilation mode.
5. If necessary, push the O₂ flush button to inflate the bellows.
6. If in **Standby**, exit **Standby** by touching the main screen or by turning on the fresh gas flow to more than 0.2 L/min.
7. To begin mechanical ventilation, set the **Auto/Manual** ventilation switch to **Auto**.

5.6.7 Volume Control Ventilation (VCV)

Volume Control Ventilation (VCV) mode is a fully-mechanical ventilation mode. In the VCV mode, each time mechanical ventilation starts, gas is delivered to the patient at a constant flow, which reaches the preset V_t within the gas delivery time. To ensure a certain amount of V_t, the resulted airway pressure (Paw) changes based on patient pulmonary compliance and airway resistance.

In VCV mode, you can set P_{limit} to prevent high airway pressure from injuring the patient. In this mode, you can select to set T_{pause} to improve patient pulmonary gas distribution and PEEP to improve expiration of end-tidal carbon dioxide and to increase oxygenation of breathing process.

To ensure the set tidal volume gas delivery, the ventilator adjusts gas flow based on the measured inspiratory volume, dynamically compensates for the loss of tidal volume arising from breathing system compliance and system leakage and eliminates the effect of fresh gas as well. This is called tidal volume compensation.

In the VCV mode, if tidal volume compensation has failed, the A5/A3 Anesthesia System can continue delivering gas stably but cannot compensate for the effects of fresh gas flow and breathing system compliance losses.

In VCV and SIMV-VC modes, when inspiration pressure reaches P_{limit}, respectively, the inspiration pressure is held.





FIGURE 5-12 Volume Control Ventilation (VCV) Tab

5.6.7.1 To Set VCV Mode

1. Select the **VCV** tab on the **Main Screen**.

2. Check that all VCV parameters are set appropriately.
If necessary, select the parameter softkey to edit the parameters settings (see FIGURE 5-12).
You can use the digital keyboard on the screen to enter the desired value, or continuously

press the  or  buttons to rapidly increase or decrease the parameter values.

3. Select the **Set Mode** softkey to confirm.

VCV parameters:

- Vt: Tidal volume (mL)
- Rate: Breath rate (bpm)
- I:E: Ratio of inspiratory time to expiratory time

NOTE: The screen displays the calculated T_{insp} when adjusting the I:E ratio (software bundle version 02.06.00 and later).

- T_{pause}: Percentage of inspiratory plateau time in inspiratory time (%)
- PEEP: Positive end-expiratory pressure (cmH₂O)
- P_{limit}: Pressure limit level (cmH₂O)

NOTE: Before activating a new mechanical ventilation mode, ensure that all related parameters are set appropriately.

5.6.8

Pressure Control Ventilation (PCV)

Pressure control ventilation (PCV) mode is a basic fully-mechanical ventilation mode. In the PCV mode, each time mechanical ventilation starts, PAW rises rapidly to the preset P_{insp}. Then gas flow slows down through the feedback system to keep PAW constant until expiration starts at the end of inspiration. The tidal volume delivered in the PCV mode changes based on patient pulmonary compliance and airway resistance.

In the PCV mode, you can set PEEP to improve expiration of end-tidal carbon dioxide and to increase oxygenation of breathing process.

For the A5, in PCV mode, Tidal Volume Guarantee (VtG) can be enabled with the VtG setting. When VtG is a value, then P_{insp} is disabled. The ventilator attempts to deliver the set VtG while maintaining the PAW at or below P_{limVG}. When VtG is Off, P_{limVG} is disabled and P_{insp} is enabled. Changing the value of P_{insp} will automatically set P_{limVG} to the same value, but P_{limVG} can be adjusted without affecting the value of P_{insp}.



NOTE: In PCV mode, even when the P_{limVG} or P_{insp} parameters are inactive, they are restricted to the parameter relationship equations $P_{limVG} \geq PEEP + 5$ and $P_{insp} \geq PEEP + 5$. See section C.9 (page C-15) "Ventilation Parameter Relationships".



FIGURE 5-13 Pressure Control Ventilation Tab

5.6.8.1 To Set PCV Mode

1. Select the **PCV** tab on the **Main Screen**.
2. Check that all PCV parameters are set appropriately.
If necessary, select the parameter softkey to edit the parameters settings (see FIGURE 5-13).
You can use the digital keyboard on the screen to enter the desired value, or continuously

press the  or  buttons to rapidly increase or decrease the parameter values.

3. Select the **Set Mode** softkey to confirm.

PCV parameters:

- VtG (A5 only): Tidal volume guarantee (mL)
- PlimVG (A5 only): pressure limit level of volume guarantee (cmH₂O)
- PInsp: Peak inspiratory airway pressure (cmH₂O)
- Rate: Breath rate (bpm)
- I:E: Ratio of inspiratory time to expiratory time

NOTE: The screen displays the calculated T_{insp} when adjusting the I:E ratio (software bundle version 02.06.00 and later).

- PEEP: Positive end-expiratory pressure (cmH₂O)
- Tslope: Rise time (sec)

NOTE: Before activating a new mechanical ventilation mode, ensure that all related parameters are set appropriately.

5.6.9 Synchronized Intermittent Mandatory Ventilation (SIMV)

The **A5** supports two modes of SIMV: SIMV-volume control (SIMV-VC) and SIMV-pressure control (SIMV-PC). The **A3** supports SIMV-VC only.

5.6.9.1 Pressure Support in Synchronized Intermittent Mandatory Ventilation (SIMV)

In SIMV-VC and SIMV-PC (A5 only) Ventilation modes, PS Ventilation can be turned on and off by changing the PS setting to On and Off, respectively. When PS Ventilation is Off, the ΔP and Tslope settings are disabled in SIMV-VC mode, and the ΔP setting is disabled in SIMV-PC mode.

5.6.9.2 Synchronized Intermittent Mandatory Ventilation–Volume Control (SIMV-VC)



FIGURE 5-14 Synchronized Intermittent Mandatory Ventilation–Volume Control (SIMV-VC) Tab

SIMV-VC means to deliver synchronized intermittent mandatory volume controlled ventilation to the patient. In the SIMV-VC mode, the ventilator waits for patient's next inspiration based on the specified time interval. The sensitivity depends on Trigger. If Trigger is reached within the trigger waiting time (called synchronous trigger window), the ventilator delivers volume controlled ventilation synchronously with the preset tidal volume and inspiratory time. If the patient does not inspire within the trigger window, the ventilator delivers volume controlled ventilation to the patient at the end of trigger window. Spontaneous breathing outside trigger window can acquire pressure support.

In VCV and SIMV-VC modes, when inspiration pressure reaches P_{limit}, the inspiration pressure is held.

5.6.9.3 Synchronized Intermittent Mandatory Ventilation–Pressure Control (SIMV-PC) - A5 Only



FIGURE 5-15 Synchronized Intermittent Mandatory Ventilation–Pressure Control (SIMV-PC) Tab

SIMV-PC is available on the A5 only. SIMV-PC means to deliver synchronized intermittent mandatory pressure controlled ventilation to the patient. In the SIMV-PC mode, the ventilator waits for patient's next inspiration based on the specified time interval. The sensitivity depends on Trigger. If Trigger is reached within the trigger waiting time (called synchronous trigger window), the ventilator delivers pressure controlled ventilation synchronously with the preset inspiratory pressure and inspiratory time. If the patient does not inspire within the trigger window, the ventilator delivers pressure controlled ventilation to the patient at the end of trigger window. Spontaneous breathing outside trigger window can acquire pressure support.

5.6.9.4 To Set SIMV-VC or SIMV-PC Mode

1. Select the **SIMV-VC** tab or **SIMV-PC** tab on the **Main Screen**.
2. Check that all **SIMV-VC** or **SIMV-PC** parameters are set appropriately. If necessary, select the parameter softkey to edit the parameters settings (see FIGURE 5-15). You can use the digital keyboard on the screen to enter the desired value, or continuously



press the  or  buttons to rapidly increase or decrease the parameter values.

3. Select the **Set Mode** softkey to confirm.

SIMV-VC parameters:

- Vt: Tidal volume (mL)
- Rate: Breath rate (bpm)
- T_{insp}: Time of inspiration (sec)

NOTE: The screen displays the calculated I:E ratio based on Rate and T_{insp} when adjusting the T_{insp} (software bundle version 02.06.00 and later).

- Tpause: Inspiratory pause (%)
- PEEP: Positive end-expiratory pressure (cmH₂O)
- Plimit: Pressure limit level
- Trigger: Flow trigger level (L/min)
- PS: Pressure support (On/Off)
- ΔP: Change in pressure (cmH₂O)
- Tslope: Rise time (sec)

SIMV-PC (A5 only) parameters:

- PInsp: Peak inspiratory airway pressure (cmH₂O)
- Rate: Breath rate (bpm)
- TInsp: Time of inspiration (sec)

NOTE: The screen displays the calculated I:E ratio based on Rate and TInsp when adjusting the TInsp (software bundle version 02.06.00 and later).

- Trigger: Flow trigger level (L/min)
- PEEP: Positive end-expiratory pressure (cmH₂O)
- Tslope: Rise time (sec)
- PS: Pressure support (On/Off)
- ΔP: Change in pressure (cmH₂O)

NOTE: Before activating a new mechanical ventilation mode, ensure that all related parameters are set appropriately.

5.6.10 Pressure Support Ventilation (PS)

In Pressure Support (PS) mode, the patient's effort is supported by the A5/A3 at a preset level of inspiratory pressure. Inspiration is triggered and cycled by patient effort.



The user can set the Trigger flow, ΔP, PEEP, minimum allowed breathing frequency, and Slope Time. If the Min Rate (bpm) is violated, the A5/A3 will give an Apnea Ventilation breath to assure ventilation is occurring.



FIGURE 5-16 Pressure Support Tab

5.6.10.1 To Set PS Mode

1. Select the **PS** tab on the **Main Screen**.
2. Check that all **PS** parameters are set appropriately. If necessary, select the parameter softkey to edit the parameters settings (see FIGURE 5-16). You can use the digital keyboard on the screen to enter the desired value, or continuously

press the  or  buttons to rapidly increase or decrease the parameter values.

3. Select the **Set Mode** softkey to confirm.

PS parameters:

- Min Rate: Minimum rate (bpm), applies to apnea backup breaths only
- ΔP : Change in pressure (cmH₂O)
- Trigger: Flow trigger level (L/min)
- PEEP: Positive end-expiratory pressure (cmH₂O)
- Tslope: Rise time (sec)
- Apnea Ti: Apnea Inspiratory Time

NOTE: Apnea Ti permits the user to vary the inspiratory time of the apnea backup breaths. Apnea backup breaths are only triggered when the patient does not achieve the Min Rate that is set by the user. If the patient's spontaneous breaths meet or exceed the Min Rate, the apnea backup is not used.

NOTE: Before activating a new mechanical ventilation mode, ensure that all related parameters are set appropriately.

5.7 Start Mechanical Ventilation

NOTE: Before starting a new mechanical ventilation mode, ensure that all related ventilation parameters are set appropriately.

To start mechanical ventilation from Standby mode:

1. Set the **Auto/Manual** ventilation switch to **Manual**.
2. Exit **Standby** by touching the main screen or by turning on the fresh gas flow to more than 0.2 L/min.
3. Set the **Auto/Manual** ventilation switch to **Auto**. The A5/A3 system will begin mechanical ventilation.

5.8 Stop Mechanical Ventilation

To stop mechanical ventilation:

1. Ensure that the breathing system is set up and the APL valve is set properly before stopping mechanical ventilation.
2. Set the **Auto/Manual** Bag switch to the **Manual** Bag position. This selects manual ventilation and stops mechanical ventilation.

5.9 Relationships of Ventilation Parameters

Ventilation modes may share the same ventilation parameters and values. For example, SIMV-VC and VCV both include V_t, P_{limit}, Rate, T_{pause}, and PEEP. Therefore, these parameter values that are linked may be passed from the previous ventilation mode to the current mode. Section C.8 "Linked Ventilation Parameter" on page C-13 includes a table that lists how the linked parameter values are set when changing ventilation modes.

Ventilation parameter values that are non-linked are set according to relationship equations. Section C.9 "Ventilation Parameter Relationships" on page C-15 includes a table of equations to show how non-linked parameter values are set when changing ventilation modes.

5.10 Parameter Monitoring (Numerics)

The system displays parameter monitored values in the monitored parameter area. The monitored parameters are separated into three groups: pressure, volume and gas (available with the AG module) or FiO₂ (available without the AG module).

5.10.1 Pressure

The **Pressure** parameter group consists of 3 parameters:

- Airway Peak Pressure (PEAK)
- Plateau Pressure (PLAT) or Mean Pressure (MEAN)
- Positive End Expiratory Pressure (PEEP)

If the parameter data is out of range, it is displayed as “-- --”.

NOTE: The high alarm limit for Airway Peak Pressure (PEAK) is displayed to the top right of the reading. The low alarm limit for Airway Peak Pressure (PEAK) is displayed to the bottom right of the reading.

NOTE: The display of either Plateau Pressure (PLAT) or Mean Pressure (MEAN) is configured from the System menu tab.



FIGURE 5-17 Pressure Parameter Group

5.10.2 Volume

The **Volume** parameter group consists of 3 parameters:

- Tidal Volume (V_T)
- Minute Volume (MV)
- Respiratory Rate (Rate)

If the parameter data is out of range, it is displayed as “-- --”.

NOTE: The high alarm limit for Minute Volume (MV) is displayed to the top right of the reading. The low alarm limit for Minute Volume (MV) is displayed to the bottom right of the reading.



FIGURE 5-18 Volume Parameter Group

5.10.3 Gas (available with the AG module)

The gas monitored parameter group consists of the following parameters:

- Fraction of inspired carbon dioxide and End-tidal carbon dioxide (FiCO₂ and EtCO₂)
- Fraction of inspired oxygen and End-tidal oxygen (FiO₂ and EtO₂)
- Fraction of inspired nitrous oxide and End-tidal nitrous oxide (FiN₂O and EtN₂O)
- Fraction of inspired anesthetic agent and End-tidal anesthetic agent (FiAA and EtAA, AA stands for anesthetic agent)
- Minimum alveolar concentration (MAC)
- Age

If the parameter data is out of range, it is displayed as "-- --".

NOTE: The high alarm limit is displayed to the top right of the reading. The low alarm limit is displayed to the bottom right of the reading.

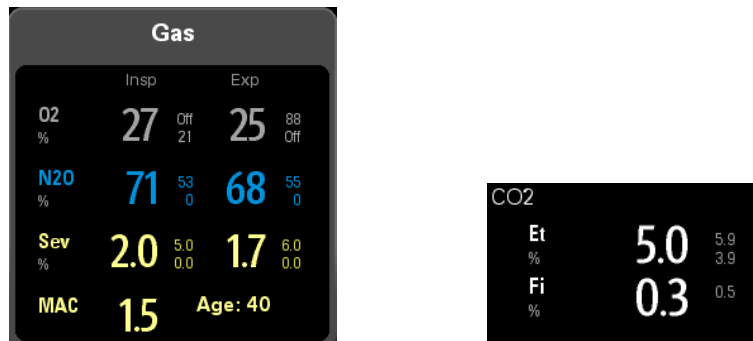

FIGURE 5-19 Gas Parameter Group

5.10.4 Inspired O₂ (available without the AG module)

The unit of measure is % (volume %). If the parameter data is out of range, it is displayed as "-- --". FiO₂ measurements between 100 % and 110 % inclusive will be displayed as 100 %. Above this range, the system will display "-- --".

FiO₂ values above 100 %, although not realistic, are possible due to errors in calibration.

NOTE: The high alarm limit is displayed to the top right of the reading. The low alarm limit is displayed to the bottom right of the reading.

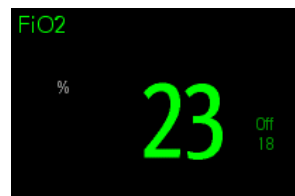

FIGURE 5-20 FiO₂ Parameter

5.11 Parameter Monitoring (Waveforms)

The system displays waveforms in the waveforms / spirometry area. The waveforms are separated into four groups: pressure waveform, flow waveform, volume waveform and gas waveform (available with the AG module).

5.11.1 Pressure Waveform

The **Pressure vs. Time** waveform is displayed in the Waveform Area.

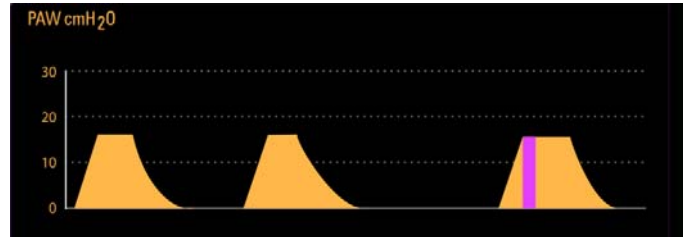

FIGURE 5-21 Example Simulated Pressure vs. Time Waveform

Pressure vs. Time

The Y-axis of the Pressure vs. Time waveform is labeled **Paw** (which represents **Airway Pressure**). The unit of measure is **cmH₂O**, hPa, or mbar. The Y-axis can automatically adjust the scales. Though the X-axis is not labeled, it represents a time scale of 0 to 15 seconds.

NOTE: The purple in the waveform means it is a triggered breath.

5.11.1.1 Auto-zeroing the Pressure Sensors

The A5/A3 auto-zeros the pressure sensors at regular intervals to compensate for changes in temperature and/or barometric pressure that could affect both pressure and flow measurements. This may affect the waveforms on the screen, but does not affect the volume/pressure delivered to the patient.

The auto-zeroing intervals are: startup, 5 mins, 15 mins, 30 mins, 60 mins, and every 120 mins thereafter.

NOTE: The A5/A3 will display the message "Auto-zeroing in process" during the auto-zeroing intervals.

5.11.2 Flow Waveform

The **Flow vs. Time** waveform is displayed in the Waveform Area.



FIGURE 5-22 Example Simulated Flow vs. Time Waveform

Flow vs. Time

The Y-axis of the Flow vs. Time waveform represents **Flow**. The unit of measure is L/min. The Y-axis can automatically adjust the scales. Though the X-axis is not labeled, it represents a time scale of 0 to 15 seconds.

NOTE: The purple in the waveform means it is a triggered breath.

5.11.3 Volume Waveform

The **Volume vs. Time** waveform can be displayed in the waveform area (software bundle version 02.02.00 and later). The default waveform displayed on the waveform area is **Flow vs. Time** waveform. Select **Setup** softkey > **Display** tab > **Waveform Display** button and select **Volume** to set the waveform display.

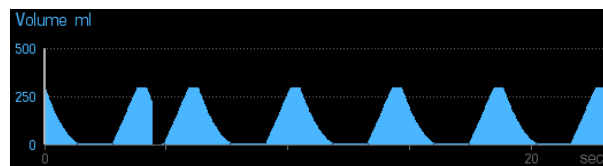

FIGURE 5-23 Example Simulated Volume vs. Time Waveform

Volume vs. Time

The Y-axis of the Volume vs. Time waveform is labeled **Volume**. The unit of measure is **ml**. The Y-axis can automatically adjust the scales. Though the X-axis is not labeled, it represents a time scale of 0 to 15 seconds.

5.11.4 Gas Waveform (available with the AG module)

The **CO₂ vs. Time** waveform can be displayed in the waveform area.

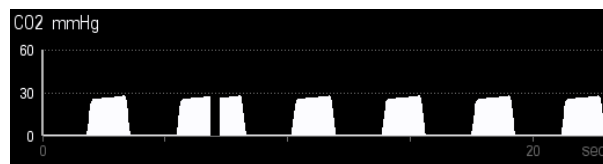

FIGURE 5-24 Example Simulated CO₂ vs. Time Waveform

CO₂ vs. Time

The Y-axis of the CO₂ vs. Time waveform is labeled **CO₂**. The unit of measure is **mmHg, kPa, or %**. The Y-axis can automatically adjust the scales. Though the X-axis is not labeled, it represents a time scale of 0 to 15 seconds.

NOTE: **N₂O, O₂, and AA waveforms are available for software bundle version 02.06.00 and later.**

The **N₂O vs. Time** waveform can be displayed in the waveform area.

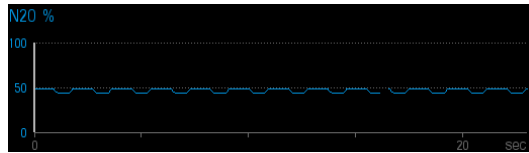

FIGURE 5-25 Example Simulated N₂O vs. Time Waveform (available with the AG module)

N₂O vs. Time

The Y-axis of the N₂O vs. Time waveform is labeled **N₂O** . The unit of measure is %. You can adjust the scales of the Y-axis (See “Gas Scales (software bundle version 02.06.00 and later, with an AG module connected)” on page 3-37.). Though the X-axis is not labeled, it represents a time scale of 0 to 15 seconds.

The **O₂ vs. Time** waveform can be displayed in the waveform area.

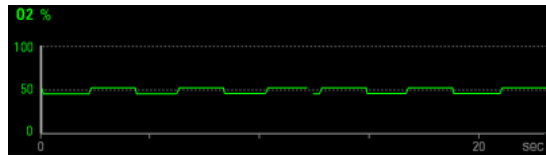

FIGURE 5-26 Example Simulated O₂ vs. Time Waveform (available with the AG module)

O₂ vs. Time

The Y-axis of the O₂ vs. Time waveform is labeled **O₂** . The unit of measure is %. You can adjust the scales of the Y-axis (See “Gas Scales (software bundle version 02.06.00 and later, with an AG module connected)” on page 3-37.). Though the X-axis is not labeled, it represents a time scale of 0 to 15 seconds.

The **AA vs. Time** waveform can be displayed in the waveform area.



FIGURE 5-27 Example Simulated AA vs. Time Waveform (available with the AG module)

AA vs. Time

The Y-axis of the AA vs. Time waveform is labeled **AA** . The unit of measure is %. You can adjust the scales of the Y-axis (See “Gas Scales (software bundle version 02.06.00 and later, with an AG module connected)” on page 3-37.). Though the X-axis is not labeled, it represents a time scale of 0 to 15 seconds. If no agent is detected, the system displays AA vs. Time waveform (see FIGURE 5-27). If an anesthetic agent such as sevoflurane is detected, the system displays Sev vs. Time waveform (see FIGURE 5-28).

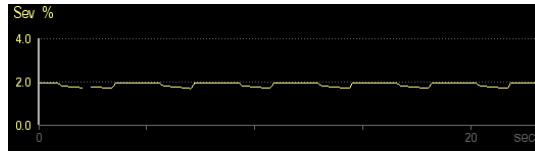

FIGURE 5-28 Example Simulated Sev vs. Time Waveform (available with the AG module)

5.11.5 Waveform Autoscaling

If the measured values of Paw, Flow, or Volume are larger than the boundary at the end of the breath cycle, the system will autoscale the Paw, Flow, or Volume at the beginning of next breath cycle.

If the measured values of Paw, Flow, or Volume are less than the boundary minus a margin (see TABLE 5-1) at the end of two continuous breath cycles, the system will autoscale the Paw, Flow, or Volume at the beginning of the next breath cycle.

SCALE	MARGIN
Paw	10 cmH ₂ O if PAW ≥ 30 cmH ₂ O 3 cmH ₂ O if PAW < 30 cmH ₂ O
Flow	10 L/min if Flow ≤ 30 L/min 15 L/min if Flow > 30 L/min
Volume	25 ml if volume ≤ 100 ml 100 ml if volume > 100 ml

TABLE 5-1 Autoscaling Margins of Paw, Flow, and Volume

5.12 Parameter Monitoring (Spirometry, A5 Only)

Spirometry is a respiratory monitoring technology that provides continuous (breath-by-breath) measurement of patient lung mechanics. The resultant pressure, volume, flow, compliance, and resistance data enables quick assessment of the patient's pulmonary status.

Open the **Spirometry Loop Window** by selecting the **SPIROMETRY** tab.

NOTE: The spirometry and waveforms can be displayed on the same screen in software bundle version 02.06.00 and later (see section 3.5 (page 3-14) "Spirometry Tab (A5 Only)").

Currently plotting loop, reference loop, and baseline loop can be displayed in manual and mechanical ventilation modes.

End the case will clear spirometry loops (baseline and reference loops).

NOTE: This will not occur when the Restore default settings box is unselected (software bundle version 02.02.00 and later).

Restart the machine will clear spirometry loops (baseline and reference loops).

Spirometry is disabled in Bypass mode. If Bypass mode is entered when the **Spirometry** tab is open, then the system will switch to the **Waveforms** tab.

Pressure - Volume Spirometry Loop

FIGURE 5-29 is an example of the Pressure - Volume loop.

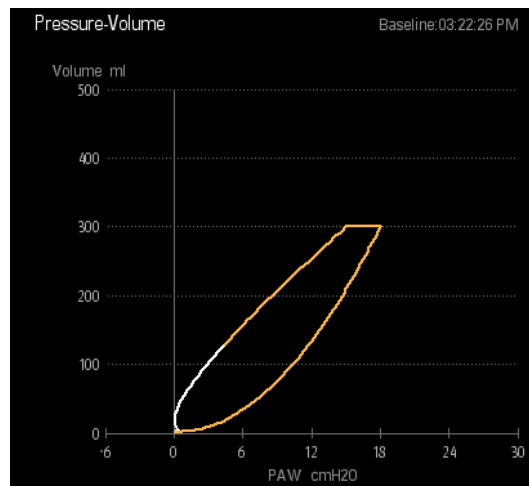

FIGURE 5-29 Pressure - Volume Loop

The Y-axis of the Pressure - Volume Spirometry loop represents **Volume**. The X-axis is labeled **Paw** (which represents **Airway Pressure**).

Flow - Volume Spirometry Loop

FIGURE 5-30 is an example of the Flow - Volume loop.

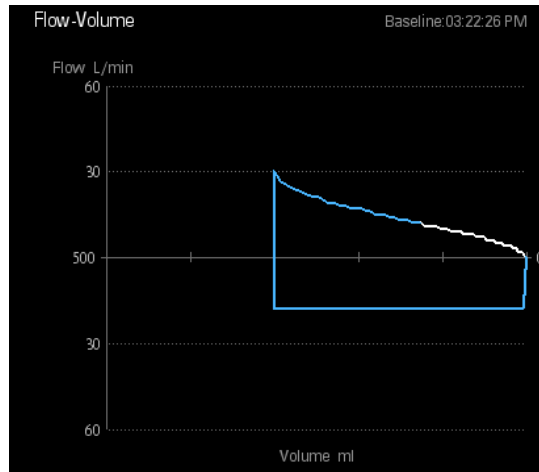

FIGURE 5-30 Flow - Volume Loop

The Y-axis of the Flow - Volume Spirometry loop represents **Flow**. The X-axis represents **Volume**.

Pressure - Flow Spirometry Loop

FIGURE 5-31 is an example of the Pressure - Flow loop.

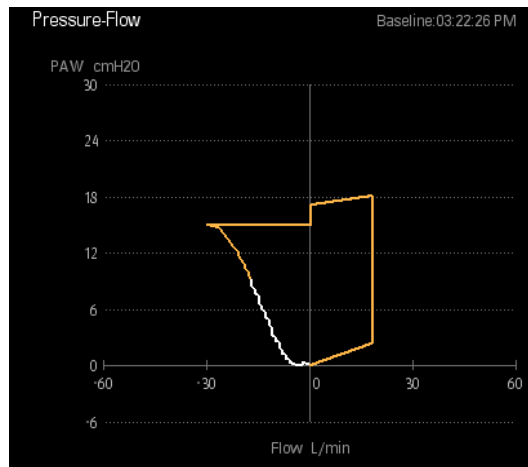

FIGURE 5-31 Pressure - Flow Loop

The Y-axis of the Pressure - Flow Spirometry loop labeled **PAW** represents airway pressure. The X-axis represents **Flow**.

This page intentionally left blank.

Alarms and Messages

Introduction	6-2
Displaying Alarms.....	6-5
Setting Alarm Volume.....	6-7
Silencing Alarms.....	6-8
Alarm Limits	6-9
Alarm and Prompt Messages	6-15

6.1 Introduction

The A5/A3 System provides alarms and messages that are indicated to the user by visual and audible alerts. Alarms and messages appear at the top of the **Main Screen** and in the **Alarms** window (see FIGURE 6-1). Users can adjust alarm properties, which include setting alarm limits to trigger alarm conditions, adjusting alarm volume, and silencing alarms.



FIGURE 6-1 Alarms and Messages On The Main Screen and In The Alarms Window

6.1.1 Alarm System Self-Test

The A5/A3 System performs a self-test of its alarm system when powered on. The self-test includes the alarm LED and speaker as follows:

- During the self-test, the alarm LED will illuminate in sequence with the colors red, yellow, and cyan for approximately 1 second each color.
- The system speaker will produce one tone after the alarm light is in self-test.

6.1.2 Types of Alarms and Messages

The A5/A3 provides the following types of alarms and messages below. See section 6.6 (page 6-15) "Alarm and Prompt Messages" for the list of alarms and messages:

- **Physiological Alarm:**
This is an alarm caused by a patient-related variable. It requires a response from the user. It can have the following priority: high, medium, or low.
- **Technical Alarm:**
This is an alarm caused by a machine-related variable. It requires a response from the user. It can have the following priority: high, medium, or low.
- **Prompt Message:**
This is a message to the user. It does not require a response from the user. It always has the lowest priority, below Physiological and Technical alarms. It is displayed in black text on white background.

6.1.3 Alarm Indicators

The A5/A3 provides the following alarm indicators:

- **An alarm LED located on top of the LCD monitor.** The LED can illuminate red, yellow, cyan, or OFF depending on the alarm condition.

TABLE 6-1 describes the alarm behavior of different alarm types and different alarm priority labels. If multiple alarms occur simultaneously, the audio and LED behavior will follow the highest priority active alarm.

- **Colored alarm messages displayed on the Main Screen.** High priority messages are red. Medium priority messages are yellow. Low priority messages are cyan. Prompt messages are black text, white background. Messages are displayed according to priority and time. (See “Displayed Order of Alarm Messages” on page 6-6.)
- **Alarm audio through the system alarm speaker.** TABLE 6-1 lists the audio behavior for each type of alarm.









ALARM TYPE	ALARM PRIORITY	AUDIO BEHAVIOR	MESSAGE BEHAVIOR	ALARM LED COLOR
Physiological Alarm	High	Play high priority alarm sound, the interval between each play is 5 ± 1 sec.	white text red background, high priority icon. 	Red
	Medium	Play medium priority alarm sound, the interval between each play is 5 ± 1 sec.	black text yellow background, medium priority icon. 	Yellow
	Low	Play low priority alarm sound, the interval between each play is 17 ± 1 sec.	white text cyan background, low priority icon. 	Cyan
Technical Alarm	High	Play high priority alarm sound, the interval between each play is 5 ± 1 sec.	white text red background, high priority icon. 	Red
	Medium	Play medium priority alarm sound, the interval between each play is 5 ± 1 sec.	black text yellow background, medium priority icon. 	Yellow
	Low	Play low priority alarm sound, the interval between each play is 17 ± 1 sec.	white text cyan background, low priority icon. 	Cyan
Prompt Message	None	None	black text with white background	Off

TABLE 6-1 Alarm Indicators (Audio and On-screen Messages)

6.2 Displaying Alarms

On the LCD monitor screen, alarm messages are automatically displayed at the top area of the **Main Screen** when alarm conditions occur (see FIGURE 6-3). Additionally, a list of all active alarms and an alarm log can be found in the **Alarms** window (see FIGURE 6-2).

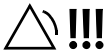
Each message is displayed with an associated priority symbol as follows:

- High priority 
- Medium priority 
- Low priority 

To display a list of all active alarms:

1. On the **Main Screen**, select the **Alarms** softkey or touch the Alarm Message area at the top of the screen.
The **Alarms** window is displayed.
2. Select the **Active** tab.
A list of all active alarm messages is displayed (see FIGURE 6-2). Up to 15 current alarms can be displayed on screen, after which a scroll bar is used to display the remaining alarms.

Alarms are displayed in order of priority and time. See section 6.2.1 (page 6-6) "Displayed Order of Alarm Messages" for more information.

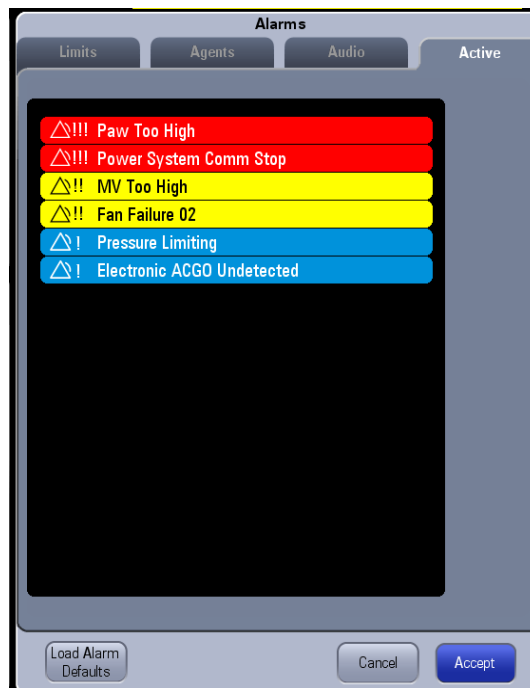

FIGURE 6-2 Active Alarms list in the Alarms window

6.2.1 Displayed Order of Alarm Messages

Alarm messages are displayed in order of priority and time of occurrence. FIGURE 6-3 shows the alarm messages list divided into two areas (Area A and Area B).

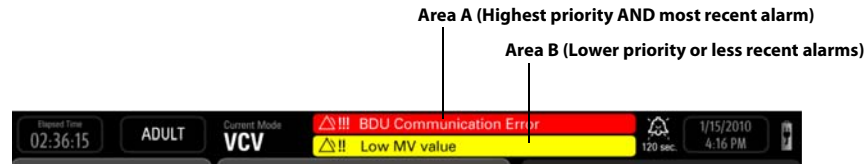

FIGURE 6-3 Displayed order of alarm messages

Alarm messages are displayed in Area A and Area B according to the following rules:

- To be in Area A, an alarm must be both the highest priority AND the most recent (Area A does not cycle). The remaining active alarms and prompt messages cycle in Area B.
- New Alarms with less priority than alarms in Area A are displayed immediately in Area B, and the cycle proceeds from that position in the list.
- Alarms cycling in Area B are grouped and displayed in the following order: highest priority, medium priority, low priority, and prompt messages. In each group, the most recent alarm is displayed first.
- If the alarm in Area A is removed, then the most recent and highest priority alarm from Area B is moved to Area A.

6.3 Setting Alarm Volume

Users can set the audio level of alarms and system alerts by selecting the **Alarms** softkey on the **Main Screen** to display the **Alarms** window (see FIGURE 6-4).

The **Alarms** volume settings adjust the audio level of all High, Medium, and Low Priority sounding alarms. The **System Alerts** volume settings adjust the audio level of all sounding pop-up prompts and non-confirmed ventilation mode alerts.

To set the Alarm Volume:

1. On the main screen, select the **Alarms** softkey. The **Alarms** window is displayed.
2. Select the **Audio** tab. Volume controls for **Alarms** and **System Alerts** are displayed.
3. Adjust the volume by selecting the + (increase) or – (decrease) buttons. The Alarms volume has 10 levels of adjustment. Default level is 3. The System Alerts volume has 10 levels of adjustment. Default level is 3.
4. Select **Accept** to activate your changes and exit the Alarms window. (Selecting **Cancel** will discard your changes and exit the Alarms window.)

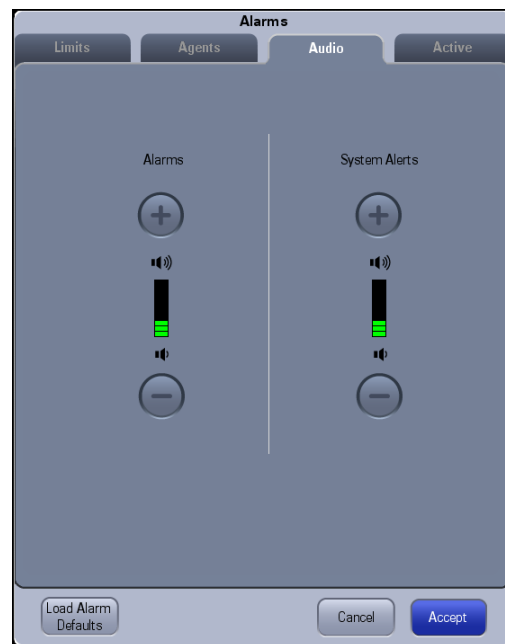

FIGURE 6-4 Audio Tab

WARNING: Do not rely exclusively on the audible alarm system when using the A5/A3 Anesthesia System. Adjustment of alarm volume to a low level may result in a hazard to the patient. Always keep the patient under close surveillance.

6.4 Silencing Alarms

When an alarm condition occurs and the alarm audio is sounded, the user can select the **Silence** softkey at the bottom of screen to silence the alarm audio. In silenced status, all the alarm indicators work normally except audible alarm tones.

Select **Silence** softkey to silence all currently sounding alarm tones. The alarm will sound if a new alarm occurs.

If the silenced alarms contain medium or high level alarms, the alarm audio will be paused for 120 seconds. The alarm silence icon and 120 second countdown time appear at the top of the screen. Select again to resume the alarm audio.

NOTE: The alarm will sound if that a new alarm occurs while the system is in an audio-paused state. If this occurs, you can select the Silence softkey again to silence the new alarm and reset the silence countdown timer to 120 seconds.

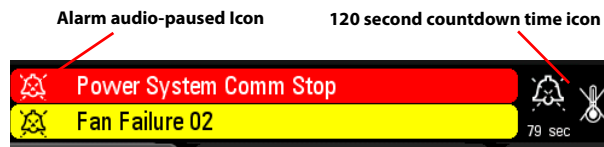

FIGURE 6-5 Alarm Audio-paused

Found in software bundle version 02.04.00 and later

If the silenced alarms are only low level alarms, the alarm audio will be turned off till there is a new alarm occurs.

NOTE: The alarm will sound if that a new alarm occurs while the system is in an audio-off state. If the new alarm is low level alarm, you can select the Silence softkey again to turn off the new alarm audio. If the new alarm is medium or high level alarm, you can select the Silence softkey again to silence the new alarm for 120 seconds.

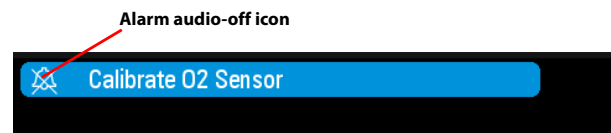

FIGURE 6-6 Alarm Audio-off

6.5 Alarm Limits

6.5.1 Setting Alarm Limits

Users can set the high and low alarm limits of Paw, MV, and FiO₂ to create alarm conditions consistent with patient needs. The alarm is then triggered when the parameter value is greater than the High Limit or lesser than the Low Limit.

NOTE: When using the A5/A3 Anesthesia System, ensure that the alarm limits of each parameter are set to the appropriate values for the patient.

There are two ways to set alarm limits:

1. On the main screen, select the **Alarms** softkey. The **Alarms** window is displayed.



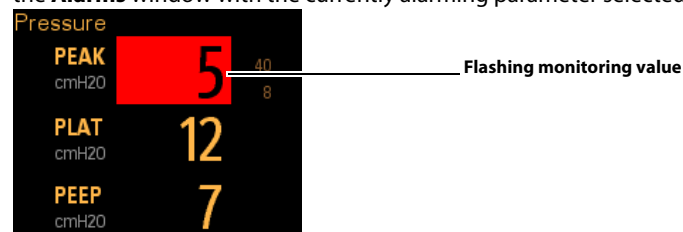

or

When the monitoring value on the main screen is flashing, select the flashing area to open the **Alarms** window with the currently alarming parameter selected.



2. Select the **Limits** tab or **Agents** tab. (see FIGURE 6-7, FIGURE 6-8 and FIGURE 6-9.)
3. Select a parameter softkey. The softkey is highlighted when selected.
4. Use the on-screen keypad to enter the desired parameter value, or continuously press



the  or  buttons to rapidly increase or decrease the parameter value. For each parameter, the range of values is displayed above the keypad. The section "Alarm Limits" on page C-3 also lists the range of values for the parameters.

5. Optionally, to restore the default values, select the **Load Alarm Defaults** button. This restores the high and low values for the parameters to the user default values.
6. Repeat Steps 3 to 4 for each parameter value.
7. Select **Accept** to save the change (or select **Cancel** to not save).

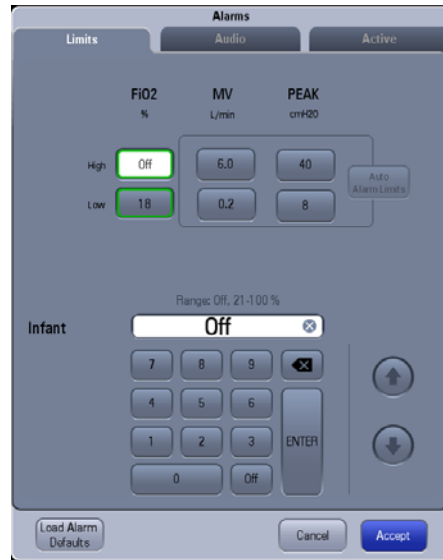

FIGURE 6-7 Limits tab in the Alarms Window (without AG module connected)



FIGURE 6-8 Limits tab in the Alarms Window (with AG module connected)

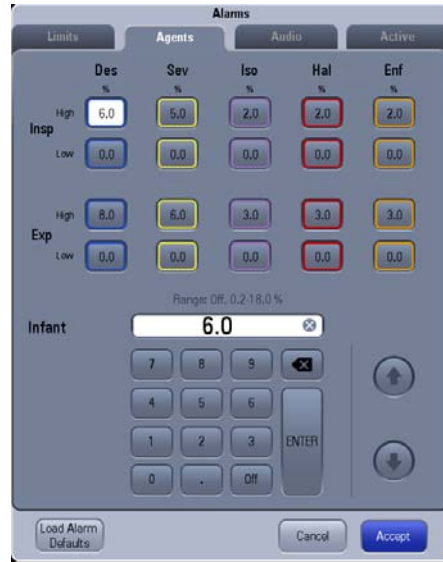

FIGURE 6-9 Agents tab in the Alarms Window (with AG module connected)

6.5.2 Loading Alarm Defaults

Users can load the user alarm limit defaults of all modules from the **Alarms** window.

To load alarm limit defaults:

1. On the **Main Screen**, select the **Alarms** softkey. The **Alarms** window is displayed.
2. Select the **Load Alarm Defaults** button at the bottom of the **Alarms** window. This restores the high and low values for the parameters to the user default values.
3. Select the **Accept** button to save these settings and close the **Alarms** window.

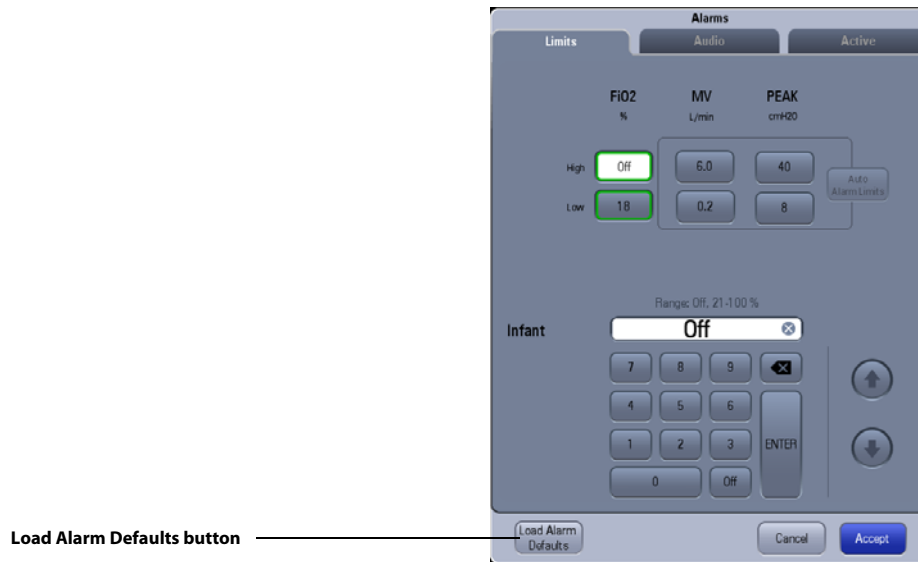

FIGURE 6-10 Load Alarm Defaults button in the **Alarms** window (without AG module connected)

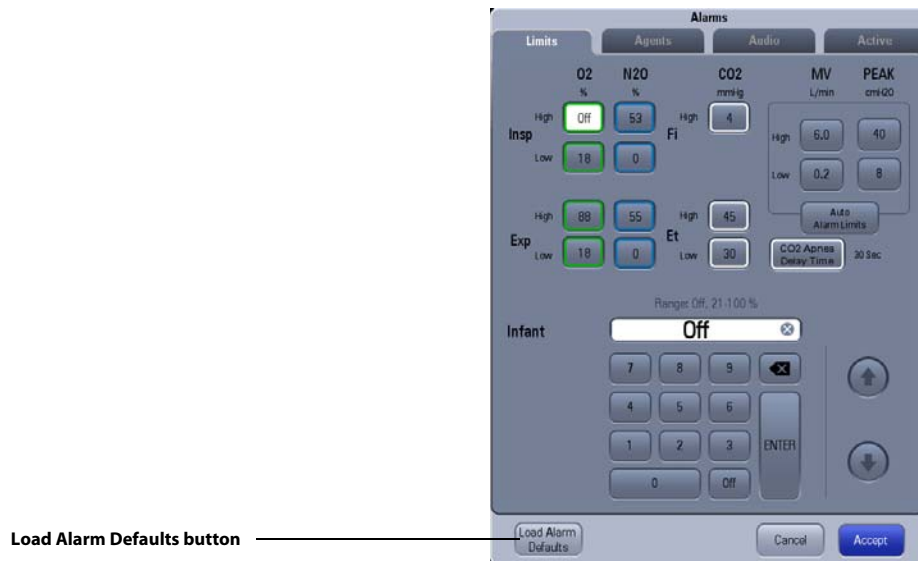
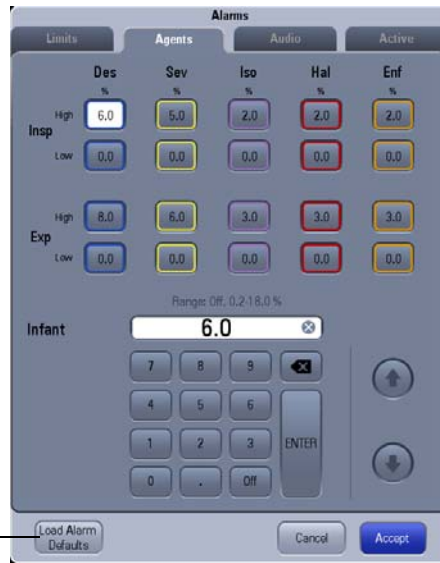

FIGURE 6-11 Load Alarm Defaults button in the **Alarms** window (with AG module connected)



Load Alarm Defaults button

FIGURE 6-12 Load Alarm Defaults button in the **Agents** window (with AG module connected)

6.5.3 Auto Alarm Limits

The Auto Alarm Limits function uses an algorithm based on measured values. The relationship is shown in the TABLE 6-2.

The **Auto Alarm Limits** button is disabled when the A5/A3 is in **Standby** mode, **Manual** mode or **Monitor** mode (with AG module). The **Auto Alarm Limits** button is also disabled when the current mode is PS, SIMV-VC, or SIMV-PC.

ALARM LIMIT	ADJUST FORMULA
Paw High	PEAK+5 or PLAT+10, whichever is greater minimum 35 cmH ₂ O
Paw Low	(PLAT-PEEP) x 0.6 + PEEP - 1 minimum 3 cmH ₂ O maximum Paw High - 1
MV High	MV x 1.4 minimum 2.0 L/min
MV Low	MV x 0.6 minimum 0.3 L/min maximum MV High - 0.1

TABLE 6-2 Auto Alarm Limits

The parameters in the formula are all measured parameters. The new alarm limits for Paw are calculated on the basis of average values for PEAK, PLAT, and PEEP. The value used for average uses the value of the last four ventilation cycles or the value in one minute, whichever is smaller. Spontaneous breaths by the patient are not taken into account.

If there is not a valid measured minute volume (MV), the corresponding MV alarm limits will not be adjusted.

If the average value for PEAK, PLAT, and PEEP cannot be calculated, the corresponding alarm limits will not be adjusted.

If the calculated alarm limit is more than the high threshold of setting range or less than the low threshold, the corresponding threshold is used as the auto alarm limit.

6.5.4 Setting CO₂ Apnea Delay Time (software bundle version 02.09.00 and later)

The **Apnea CO₂** alarm is triggered when no breath is detected within a specified time.

To set the CO₂ Apnea Delay Time:

1. On the main screen, select the **Alarms** softkey.
The **Alarms** window displays.
2. Select the **Limits** tab. (see FIGURE 6-7 and FIGURE 6-8)
3. Select the **CO₂ Apnea Delay Time** button and set it to **10 sec, 15 sec, 20 sec, 25 sec, 30 sec, 35 sec, or 40 sec.**

6.6 Alarm and Prompt Messages

This section lists the following alarms and messages:

- Physiological Alarm Messages
- Technical Alarm Messages
- Prompt Messages

For each alarm message, corresponding actions are given instructing you to troubleshoot problems. If the problem persists, contact your service personnel.

NOTE: The Disable in Manual and Cardiac Bypass mode column indicates how this alarm is controlled by the alarm on/off button and the cardiac bypass mode button in manual mode.

NOTE: The Disabled in Standby mode column indicates which physiological alarms will be disabled automatically in Standby mode.

NOTE: The Disabled in Monitor mode column indicates which physiological alarms will be disabled automatically in Monitor mode.

Physiological Alarm Messages

MESSAGE	CAUSE	ALARM PRIORITY	DISABLED WHEN ALARM IS OFF	DISABLED IN STANDBY MODE	DISABLED IN MONITOR MODE
Apnea	Two triggering conditions occur simultaneously: 1. Paw < (PEEP+3) cmH ₂ O for more than 30 seconds 2. Vt < 10 ml for more than 30 seconds	Medium	Yes	N/A *	Yes
Apnea >2 min	No breath has been detected within the last 120 seconds.	High	Yes	N/A *	Yes
Paw Too High	Ppeak ≥ Paw high alarm limit setting	High	Yes	N/A *	Yes
Paw Too Low	Ppeak ≤ Paw low alarm limit setting for 20 seconds	High	Yes	N/A *	Yes
Pressure Limiting	Paw ≥ Plimit	Low	N/A *	N/A *	N/A*
FiO₂ Too High	FiO ₂ > high alarm limit setting	Medium	No	N/A *	No
FiO₂ Too Low	FiO ₂ < low alarm limit setting	High	No	N/A *	No
MV Too High	MV > high alarm limit setting	Medium	Yes	N/A *	Yes
MV Too Low	MV < low alarm limit setting	Medium	Yes	N/A *	Yes

* N/A - Not Applicable. This alarm message does not exist within this mode and therefore cannot be disabled or enabled.

TABLE 6-3 Physiological Alarm Messages

MESSAGE	CAUSE	ALARM PRIORITY	DISABLED WHEN ALARM IS OFF	DISABLED IN STANDBY MODE	DISABLED IN MONITOR MODE
Continuous Airway Pressure	Paw in the breathing circuit > sustained airway pressure alarm limit for 15 seconds	High	No	N/A *	Yes
Negative Pressure	Paw < -10 cmH ₂ O for 1 second.	High	No	N/A *	Yes
EtCO₂ Too High	EtCO ₂ > high alarm limit setting	Medium	No	Yes	No
EtCO₂ Too Low	EtCO ₂ < low alarm limit setting	Medium	No	Yes	No
FiCO₂ Too High	FiCO ₂ > high alarm limit setting	Medium	No	Yes	No
EtN₂O Too High	EtN ₂ O > high alarm limit setting	Medium	No	Yes	No
EtN₂O Too Low	EtN ₂ O < low alarm limit setting	Medium	No	Yes	No
FiN₂O Too High	FiN ₂ O > high alarm limit setting	Medium	No	Yes	No
FiN₂O Too Low	FiN ₂ O < low alarm limit setting	Medium	No	Yes	No
EtHAL Too High	EtHAL > high alarm limit setting	Medium	No	Yes	No
EtHAL Too Low	EtHAL < low alarm limit setting	Medium	No	Yes	No
FiHAL Too High	FiHAL > high alarm limit setting	Medium	No	Yes	No
FiHAL Too Low	FiHAL < low alarm limit setting	Medium	No	Yes	No
EtENF Too High	EtENF > high alarm limit setting	Medium	No	Yes	No
EtENF Too Low	EtENF < low alarm limit setting	Medium	No	Yes	No
FiENF Too High	FiENF > high alarm limit setting	Medium	No	Yes	No
FiENF Too Low	FiENF < low alarm limit setting	Medium	No	Yes	No
EtISO Too High	EtISO > high alarm limit setting	Medium	No	Yes	No
EtISO Too Low	EtISO < low alarm limit setting	Medium	No	Yes	No
FiISO Too High	FiISO > high alarm limit setting	Medium	No	Yes	No
FiISO Too Low	FiISO < low alarm limit setting	Medium	No	Yes	No
EtSEV Too High	EtSEV > high alarm limit setting	Medium	No	Yes	No

* N/A - Not Applicable. This alarm message does not exist within this mode and therefore cannot be disabled or enabled.

TABLE 6-3 Physiological Alarm Messages

MESSAGE	CAUSE	ALARM PRIORITY	DISABLED WHEN ALARM IS OFF	DISABLED IN STANDBY MODE	DISABLED IN MONITOR MODE
EtSEV Too Low	EtSEV < low alarm limit setting	Medium	No	Yes	No
FiSEV Too High	FiSEV > high alarm limit setting	Medium	No	Yes	No
FiSEV Too Low	FiSEV < low alarm limit setting	Medium	No	Yes	No
EtDES Too High	EtDES > high alarm limit setting	Medium	No	Yes	No
EtDES Too Low	EtDES < low alarm limit setting	Medium	No	Yes	No
FiDES Too High	FiDES > high alarm limit setting	Medium	No	Yes	No
FiDES Too Low	FiDES < low alarm limit setting	Medium	No	Yes	No
EtO₂ Too High	EtO ₂ > high alarm limit setting	Medium	No	Yes	No
EtO₂ Too Low	EtO ₂ < low alarm limit setting	Medium	No	Yes	No
Apnea CO₂	No breath is detected and Apnea time ≥ Apnea alarm time.	High	Yes	Yes	No

* N/A - Not Applicable. This alarm message does not exist within this mode and therefore cannot be disabled or enabled.

TABLE 6-3 Physiological Alarm Messages

NOTE: If an Apnea CO₂ alarm occurs, the CO₂ apnea elapse timer will display on the CO₂ waveform screen. The time displayed is the time since the last breath and the time will reset once the CO₂ Apnea alarm has cleared (software bundle version 02.06.00 and later).

6.6.1 Technical Alarm Messages

6.6.1.1 Startup Alarm Messages

NOTE: Startup alarms will not trigger the alarm sound and alarm light.

NOTE: Startup alarms priority is only used to display in the Service menu alarm logbook.

NOTE: Startup Result if Fail column indicates the result when this startup phase alarm is triggered, which may be ALL, only manual, and Non-Functional.

NOTE: "All" indicates that all Automatic Ventilation, Manual Ventilation, and Cardiac Bypass modes are enabled.

"Only Manual" indicates that only Manual Ventilation and Cardiac Bypass modes are enabled.

"Non-Functional" indicates that the A5/A3 Anesthesia System cannot be used.

MESSAGE	CAUSE	ALARM PRIORITY	MACHINE MODE WHEN CHECKED	STARTUP RESULT IF FAIL	REMARK
Bundle Version Error / Incompatible version found	Incompatible firmware version is installed.	High	Startup	Non-Functional	CPU Board
Bundle Version: Time out	Self-test result cannot be obtained due to an internal communication error.	High	Startup	Non-Functional	CPU Board
Flowmeter Voltage Error / Flowmeter Voltage: Fail	DVCC, AVDD or VC voltage error	High	Startup	Only Manual	Electronic Flowmeter Board
Flowmeter Self Test Error / Flowmeter Self Test Fail	CPU, Flash or WTD error	High	Startup	Non-Functional	Electronic Flowmeter Board
Flowmeter Self Test: Time out	Self-test result cannot be obtained due to an internal communication error.	High	Startup	Non-Functional	Electronic Flowmeter Board
Aux Control Module Self Test Error / Aux Control Module Self Test: Fail	1. CPU, Flash or WTD error 2. After power on, CPU board can't communicate with the Aux Control board.	High	Startup	Non-Functional	Aux Vent Control Board
Aux Control Module Self Test: Time out	Self-test result cannot be obtained due to an internal communication error.	High	Startup	Non-Functional	Aux Vent Control Board

TABLE 6-4 Startup Alarm Messages

MESSAGE	CAUSE	ALARM PRIORITY	MACHINE MODE WHEN CHECKED	STARTUP RESULT IF FAIL	REMARK
Ventilator Self Test Error / Ventilator Self Test: Fail	1. CPU, TIMER, RAM, WTD, EEPROM or AD error 2. After power on, CPU board cannot communicate with the ventilator board.	High	Startup	Non-Functional	Ventilator Control Board
Ventilator Self Test: Time out	Self-test result cannot be obtained due to an internal communication error.	High	Startup	Non-Functional	Ventilator Control Board
Ventilator Voltage Error / Ventilator Voltage: Fail	5 V or 12 V voltage error	High	Startup	Only Manual	Ventilator Control Board
PEEP Valve Failure / PEEP Valve: Fail	1. PEEP valve voltage error. 2. PEEP valve pressure error.	Medium	Startup	Only Manual	Ventilator Control Board
Insp Valve Failure / Insp Valve: Fail	1. Inspiratory valve voltage error. 2. Inspiratory valve flow error.	Medium	Startup	Only Manual	Ventilator Control Board
Safety Valve Failure / Safety Valve: Fail	PEEP safety valve voltage error.	Medium	Startup	Only Manual	Ventilator Control Board
Flow Sensor Failure / Flow Sensor: Fail	Ventilator flow is out of range.	Low	Startup	Only Manual	Ventilator Control Board
Calibrate Flow Sensor and Insp Valve	1. Calibration table isn't found in EEPROM. 2. Checksum of Calibration table does not match.	Low	Startup	Only Manual	Ventilator Control Board
Calibrate Pressure Sensor and PEEP Valve	1. Calibration table isn't found in EEPROM. 2. Checksum of Calibration table does not match.	Low	Startup	Only Manual	Ventilator Control Board
Perform 100% O₂ Sensor Calibration	1. Calibration table isn't found in EEPROM. 2. Checksum of Calibration table does not match.	Low	Startup	All	Ventilator Control Board
Ventilator Initialization Error / Ventilator Initialization: Fail	After powering on, CPU board cannot send the parameter settings to the ventilator board.	High	Startup	Non-Functional	CPU Board

TABLE 6-4 Startup Alarm Messages

MESSAGE	CAUSE	ALARM PRIORITY	MACHINE MODE WHEN CHECKED	STARTUP RESULT IF FAIL	REMARK
Ventilator Initialization: Time out	Self-test result cannot be obtained due to an internal communication error.	High	Startup	Non-Functional	CPU Board
Drive Gas Pressure Low	Drive Gas Pressure is low.	High	Startup	All	Ventilator Control Board
O₂ Supply Failure / O₂ Supply: Fail	O ₂ Supply Failure.	High	Startup	All	Ventilator Control Board
Power Supply Voltage Error / Power Supply Voltage: Fail	3.3 V, 5 V, 12 V voltage error.	High	Startup	Only Manual	Power Board
RT Clock Needs Battery	There is no button battery cell available in the system, or the button battery cell power is depleted.	High	Startup only	All	CPU Board
RT Clock Failure / RT Clock: Fail	RT chip malfunction.	High	Startup only	All	CPU Board
External AG Self Test Error	If the module sends the ErrorMessage, except for data limit error and unspecified accuracy, "External AG Self Test Error" will be triggered.	Low	Startup only	All	AG Module
External AG: Time out	External AG selftest result can-not be obtained due to communication error.	Low	Startup only	All	AG Module

TABLE 6-4 Startup Alarm Messages

6.6.1.2 CPU Board Runtime Alarm

MESSAGE	CAUSE	ALARM PRIORITY	MACHINE MODE WHEN CHECKED	DISABLE IN STANDBY MODE
IP Address Conflict	The IP address of the machine is the same as the IP address of another device in the local network.	Medium	Runtime	No
Fan Failure	Speed of the fan \leq 20% of normal speed	Medium	Runtime	No
Fan Failure O₂	Speed of Module Rack fan < 3640	Medium	Runtime	No

TABLE 6-5 CPU Board Runtime Alarm Messages

6.6.1.3 Power Board Runtime Alarm

MESSAGE	CAUSE	ALARM PRIORITY	MACHINE MODE WHEN CHECKED	DISABLE IN STANDBY MODE
Power System Comm Stop	Lost communication with CPU board for 10 seconds.	High	Runtime	No
Power Supply Voltage Error	3.3 V, 5 V, 12 V voltage error	High	Runtime	No
Low Battery Voltage!	Battery voltage is less than 10.6 V for 5 seconds.	High	Runtime	No
System going DOWN, Battery depleted!	Battery voltage is less than 10.2 V.	High	Runtime	No
Battery Undetected	Battery undetected	Medium	Runtime	No
Battery in Use	AC power fail	Low	Runtime	No
Power Board High Temp	Power board temperature is greater than 95° C	High	Runtime	No
Heating Module Failure	1. Both resistance temperatures are greater than 105° C or less than 0° C for 20 seconds. 2. One of the resistance temperatures is greater than 110° C for 15 seconds.	Low	Runtime	No
Breathing Circuit Not Mounted	Breathing Circuit is not mounted.	High	Runtime	No

TABLE 6-6 Power Board Runtime Alarm Messages

NOTE: If the power board loses communication with the CPU board for 10 seconds, the alarm buzzer will be turned on.

NOTE: If the system restarts accidentally, the alarm buzzer will sound for 10 seconds to show notification.

6.6.1.4 Electronic Flowmeter Board Runtime Alarm

MESSAGE	CAUSE	ALARM PRIORITY	MACHINE MODE WHEN CHECKED	DISABLE IN STANDBY MODE
Flowmeter Voltage Error	DVCC, AVDD, or VC voltage error	High	Runtime	No
N₂O Flow Too High	N ₂ O flow is greater than 15 L/min for 1 second.	Low	Runtime	No
O₂ Flow Too High	O ₂ flow is greater than 25 L/min for 1 second.	Low	Runtime	No
Air Flow Too High	Air flow is greater than 20 L/min for 1 second.	Low	Runtime	No

TABLE 6-7 Electronic Flowmeter Board Runtime Alarm Messages

MESSAGE	CAUSE	ALARM PRIORITY	MACHINE MODE WHEN CHECKED	DISABLE IN STANDBY MODE
O₂-N₂O Ratio Error	N ₂ O flow is greater than 0.5 L/min and greater than 4 times O ₂ flow for 1.6 seconds.	High	Runtime	No
Flowmeter Comm Stop	Lost communication with CPU board for 10 seconds. When this alarm is triggered, the fresh gas flow value will be displayed as '---'.	High	Runtime	No
NO Fresh Gas	Fresh gas flow is less than 50 mL/min for 5 seconds when the machine is not in Standby mode or Monitor mode..	Medium	Runtime	Yes
Internal N₂O Flow Failure	The I2C communication between the CPU and N ₂ O flow sensor has failed.	Low	Runtime	No
Internal O₂ Flow Failure	The I2C communication between the CPU and O ₂ flow sensor has failed.	Low	Runtime	No
Internal Air Flow Failure	The I2C communication between the CPU and Air flow sensor has failed.	Low	Runtime	No

TABLE 6-7 Electronic Flowmeter Board Runtime Alarm Messages

6.6.1.5 Ventilator Control Board Runtime Alarm

MESSAGE	CAUSE	ALARM PRIORITY	MACHINE MODE WHEN CHECKED	DISABLE IN STANDBY MODE
Aux Control Module Comm Stop	Lost communication with CPU board for 10 seconds.	High	Runtime	No
Ventilator Voltage Error	5 V or 12 V voltage error	High	Runtime	No
PEEP Valve Failure	1. PEEP valve voltage error 2. PEEP valve pressure error	Medium	Runtime	No
Insp Valve Failure	1. Inspiratory valve voltage error 2. Inspiratory valve flow error	Medium	Runtime	No
Safety Valve Failure	PEEP safety valve voltage error	Medium	Runtime	No
Flow Sensor Failure	1. Inspiratory flow is out of range. 2. Expiratory flow is out of range.	Low	Runtime	No

* N/A - Not Applicable. This alarm message does not exist within this mode and therefore cannot be disabled or enabled.

TABLE 6-8 Ventilator Control Board Runtime Alarm Messages

MESSAGE	CAUSE	ALARM PRIORITY	MACHINE MODE WHEN CHECKED	DISABLE IN STANDBY MODE
Check Flow Sensors	1. Inspiratory reverse flow 2. Expiratory reverse flow	High	Runtime	N/A *
Pinsp Not Achieved	Pinsp does not reach the Pinsp setting in pressure mode.	Low	Runtime	N/A *
Vt Not Achieved	Vt does not reach the Vt setting in volume mode.	Low	Runtime	N/A *
Auto Ventilation Disabled	When system is in the Auto Ventilation, Non functional state	High	Runtime	N/A*
Automatic Ventilation Disabled	The machine is in the automatic ventilation disabled state.	Low	Runtime	No
Auto Ventilation Disabled-Leak Test Failed	Automatic Circuit Leak Test failed, and the result is "Manual Only".	Low	Runtime	No
Patient Circuit Leak	1. Ppeak is less than 2cmH ₂ O for continuously 30s during mechanical ventilation. 2. Patient is not connected.	Medium	Runtime	N/A*
CO₂ Absorber Canister Not Locked	CO ₂ Canister is not mounted.	High	Runtime	No
O₂ Sensor Disconnected	O ₂ Sensor is not connected.	Low	Runtime	No
Replace O₂ sensor	The O ₂ value is less than 5 %.	Medium	Runtime	No
Perform 100% O₂ Sensor Calibration	O ₂ value is greater than 110 % or between 5 % and 15 % for 3 seconds.	Low	Runtime	No
Ventilator Comm Stop	Lost communication with the CPU board for 10 seconds.	High	Runtime	No
Drive Gas Pressure Low	Drive Gas Pressure is low.	High	Runtime	No
O₂ Supply Failure	O ₂ Supply Failure	High	Runtime	No
Fresh Gas Flow Too High	In VCV and SIMV-VC modes, the fresh gas flow is greater than or equal to the desired flow.	Low	Runtime	N/A*

* N/A - Not Applicable. This alarm message does not exist within this mode and therefore cannot be disabled or enabled.

TABLE 6-8 Ventilator Control Board Runtime Alarm Messages

6.6.1.6 Anesthetic Gas (AG) Module Alarm Messages

MESSAGE	CAUSE	ALARM PRIORITY	MACHINE MODE WHEN CHECKED	DISABLE WHEN EXTERNAL AG IS IN STANDBY MODE
AG Hardware Error	AG module Hardware Error.	Medium	Runtime	Yes
O₂ Sensor Error	Paramagnetic O ₂ sensor error.	Medium	Runtime	Yes
External AG Self Test Error	Module fault or communication failure between the module and anesthesia system.	Low	Runtime	Yes
AG Hardware Malfunction	AG module hardware malfunction. The AG module enters Standby and measurement stops.	High	Runtime	Yes
AG Init Error	The AG module was installed improperly or malfunctioned.	High	Runtime	Yes
AG No Watertrap	The AG module watertrap was installed improperly or not installed.	Low	Runtime	Yes
AG Watertrap Type Wrong	When the patient type is infant, but the watertrap type is adult/pediatric, this alarm will be triggered.	Low	Runtime	Yes
AG Change Watertrap	When the actual flow is less than 75 % of the set flow, the alarm indicates that the watertrap is gradually occluded and it is necessary to replace the water trap.	Medium	Runtime	Yes
AG Comm Stop	AG module malfunction or communication failure.	High	Runtime	No
AG Airway Occluded	Pump rate is lower than 20 ml/min for 1 second.	High	Runtime	Yes
AG Zero Failed	Gas measurements may have bad accuracy during zeroing.	Low	Runtime	Yes
Mixed Agent and MAC < 3	More than one anesthetic gas and MAC < 3	Low	Runtime	Yes
Mixed anesthetic gas and MAC >= 3	More than one anesthetic gas and MAC >= 3	Medium	Runtime	Yes

TABLE 6-9 AG Module Alarm Messages

MESSAGE	CAUSE	ALARM PRIORITY	MACHINE MODE WHEN CHECKED	DISABLE WHEN EXTERNAL AG IS IN STANDBY MODE
Incompatible AG Software Version	The AG Version Limit is On, and the AG module is loaded while the AG software version is lower than 1.7.3.0	High	Runtime	No
CO₂ Over Range	The monitoring value exceeds the measurable range.	Low	Runtime	Yes
N₂O Over Range				
Hal Over Range				
Enf Over Range				
Iso Over Range				
Sev Over Range				
Des Over Range				
O₂ Over Range	The monitoring value of Rate exceeds the measurable range. when this type of alarm is triggered, "--" will be displayed.	Low	Runtime	Yes
Rate Over Range				

TABLE 6-9 AG Module Alarm Messages

6.6.2 Prompt Messages

6.6.2.1 Prompt Messages Displayed in Alarm Area

MESSAGE	TIMEOUT	REMARK
Pressure, Volume and Apnea Alarms are OFF	Correspond status does not exist.	This Alarms Off icon and message appear on a white background when the Alarms button in the Manual mode tab is set to Off .
CO₂ and CO₂ Apnea Alarms are OFF (software bundle version 02.04.00 and later)	Correspond status does not exist.	This message appears when the CO ₂ Alarms button in the Manual mode tab is set to OFF.
Load Configuration Failure	10 sec	This message appears when the download or latest configuration update failed.
DEMO Mode - Not for Clinical Use	Never	This message appears when the system is set to demo mode from the Service tab.
Service Mode - Not for Clinical Use	Never	This message appears when the machine is worked in Service mode.
Apnea Ventilation	Correspond status does not exist.	This message appears when the Min Rate triggers a breath in PS ventilation mode.
Calibrate O₂ sensor for 21 %	<ul style="list-style-type: none"> • When the machine is powered on, if more than 72 hours have elapsed since the last successful calibration, the prompt message "Calibrate O₂ sensor for 21%" is displayed. The message disappears after successful calibration. • If the machine is kept powered on, the prompt message "Calibrate O₂ sensor for 21%" is displayed at the next Standby mode after 5am after 72 hours have elapsed since the last successful calibration. • If the alarm message "RT Clock Needs Battery" or "RT Clock Failure" is displayed, the prompt message "Calibrate O₂ sensor for 21%" is disabled. • If the calibrate time is empty, the prompt message "Calibrate O₂ sensor for 21%" is displayed. 	
Auto-zero in process	Correspond status does not exist.	This message appears when auto-zeroing of the pressure sensors is in process.
Fresh Gas Is On	Correspond status does not exist.	This message is displayed if the fresh gas flow value is flashing in Standby mode.
New functions activated, please restart!	After the machine restart	This message appears when activation successfully completed.
Calibrate O₂ sensor for 100%	It will not disappear until O ₂ sensor calibration successfully performed	This message displays when the 100 % calibration data could not be revised correctly after 21% O ₂ sensor calibrate successfully.
Could not locate time server	It will not disappear until the Interval of SNTP Protocol is set to Off or the time server is available again.	This message displays when the Interval SNTP Protocol is not Off and the time server is unavailable for five (5) intervals.
External AG Loaded Successfully	5 s	"External AG Loaded Successfully." and "External AG Unloaded." will not display at the same time.
External AG Unloaded Successfully	5 s	Only the latest one will be shown when both of them exist.

TABLE 6-10 Prompt Messages Displayed in Alarm Area

MESSAGE	TIMEOUT	REMARK
External AG Startup	/	External AG module is starting up. This prompt message is triggered by External AG.
External AG Warmup	/	External AG module is warming up. This prompt message is triggered by External AG.
External AG Zeroing	/	Gas concentrations cannot be measured during zero, instead the last measured concentrations are reported to the application.
Leak Test Not Performed	Only appears in standby mode. It will disappear when both the automatic and manual leak test has been performed.	This message displays when either the automatic leak test or manual leak test was skipped from startup, or when the last time that the leak test was performed was more than 24 hours ago (software bundle version 02.06.00 and later).

TABLE 6-10 Prompt Messages Displayed in Alarm Area

6.6.2.2 Prompt Messages Displayed in Pop-up Area

MESSAGE	TIMEOUT	REMARK
Can only End Case in Manual Mode!	5 sec	This message appears if the End Case button is selected when the Manual switch is set to Auto and the machine is in non-standby.
Invalid Age! Please check DOB or current system time.	5 sec	This message appears after entering the patient's date of birth if the calculated age of the patient is outside the accepted range (0-150).
Patient Size can only be changed in Manual Mode or in Standby	5 sec	This message appears when the Patient Size selection is pressed while the system is in Automatic Ventilation mode.
Vent modes can only be changed using "Set Mode" button below	5 sec	This message appears when the Current Mode area is pressed.
Out of Range	5 sec	This message appears when the entered value is outside the allowable range.
Invalid Password	5 sec	This message appears when the entered password is wrong.
Saving User Configuration has failed.	5 sec	This message appears when the Saving User Configuration process has failed.
New password input is inconsistent.	5 sec	This message appears when the new password and the confirmed new password do not match.
Automatic ventilation disabled. Check lever on breathing system.	15 sec	This message appears when exiting Standby mode while the Auto/Manual switch is in Auto position and system is in the Automatic Ventilation disabled state.

TABLE 6-11 Prompt Messages Displayed in Pop-up Area

MESSAGE	TIMEOUT	REMARK
Fresh gas flow detected! Adjust all flowmeters to zero	After fresh gas flow is turned off or after exiting "Manual Circuit Leak Test" or "Automatic Circuit Leak Test & Compliance Test" screen.	This message appears in the first "Manual Circuit Leak Test" or "Automatic Circuit Leak Test & Compliance Test" screen when fresh gas flow is detected.
Access to System settings only available in Standby	5 sec	This message appears when the current mode is in non-standby and the user tries to enter the Setup > System menu.
Can not end case while fresh gas flow is detected!	5 sec	This message appears when user tries to end the case by pressing the disabled End Case button while fresh gas is on, Auto/Manual switch is set to Manual , and the system is in non-standby.
Set Auto/Manual switch to Manual position before starting case	1. When triggered by turning on fresh gas, it will disappear after fresh gas flow is turned off or Auto/Manual switch is set to Manual ; 2. When triggered by touching the Waveforms/Spirometry screen, it will disappear after 5 seconds or Auto/Manual switch is set Manual .	When Auto/Manual switch is in Auto position and system is in Standby mode, this message will appear in the following cases: 1. Turning on fresh gas 2. Touching the Waveforms/Spirometry screen
Set Auto/Manual switch to Manual position and adjust all flowmeters to zero.	5 sec	This message appears in the first "Automatic Circuit Leak Test & Compliance Test" screen when pressing the disabled Continue button.
Set Auto/Manual switch to Auto position and adjust all flowmeters to zero.	5 sec	This message appears in the first "Manual Circuit Leak Test" screen when pressing the disabled Continue button.
Can only End Case in Manual Mode!	5 sec	This message displays when the Auto/Manual switch is in Auto position and the system is in non-Standby, then if the user presses the disabled End Case button.

TABLE 6-11 Prompt Messages Displayed in Pop-up Area

Maintenance

Theory of Operation	7-3
Block Diagram.....	7-3
Maintenance Schedule	7-4
Breathing System Maintenance.....	7-4
Flow Sensor Calibration	7-5
O2 Sensor Calibration	7-6
Water Build-up in the Flow Sensor	7-9
AGSS Transfer Tube Maintenance.....	7-9
Electrical Safety Inspection.....	7-9
Cleaning and Disinfection	7-11
Regular Maintenance	7-30

-
- WARNING:** Do not use a malfunctioning A5/A3 Anesthesia System. Have all repairs and service done by an authorized service representative.
- WARNING:** Use a cleaning and disinfection schedule that conforms to your institution's disinfection and risk-management policies.
- Refer to the material safety data sheet as applicable.
 - Refer to the operation and maintenance manuals of all disinfection equipment.
 - Do not inhale fumes that may result from any disinfection process.
- WARNING:** Do not use talc, zinc stearate, calcium carbonate, corn starch, or similar material to prevent sticking of the bellows, as these materials may enter the patient's lungs or airway, causing irritation or injury.
- WARNING:** Only use lubricants approved for anesthesia or O₂ equipment.
- WARNING:** Do not use lubricants that contain oil or grease. They can burn or explode in the presence of high O₂ concentrations.
- WARNING:** Obey infection control and safety procedures. Utilized equipment may contain blood and body fluids.
- WARNING:** Movable parts and removable components may present a pinch or a crush hazard. Use care when moving or replacing system parts and components.
- WARNING:** Before using the A5/A3 System (after cleaning or disinfecting), power up the system and follow the on-screen prompts to perform the leak test and the compliance test. (see section 4.5 (page 4-9) "Leak and Compliance Tests".)
- CAUTION:** To prevent system damage:
- Refer to the literature supplied by the manufacturer of the cleaning agent.
 - Never use organic, halogenated or petroleum-based solvents, anesthetics, glass cleaning agents, acetone or other irritant agents.
 - Never use abrasive agents (i.e. steel wool or silver polish) to clean components.
 - Keep all liquids away from electronic components.
 - Prevent liquid from entering the equipment.
 - All cleaning solutions used must have a pH between 7.0 and 10.5.
- CAUTION:** Never immerse the oxygen sensor or its connector in any type of liquid. Dispose of the oxygen sensor as per the local regulations.
- CAUTION:** Do not wash the inner surface of the oxygen sensor.
- CAUTION:** Do not autoclave the following components: Paw gauge, oxygen sensor, flow sensor, and bellows. These components cannot withstand immersion or the heat and pressure of autoclaving.
- NOTE:** No repair should ever be attempted by anyone not having experience in the repair of devices of this nature. Replace damaged parts with components manufactured or sold by Mindray. Then test the unit to ensure that it complies with the manufacturer's published specifications.

7.1 Theory of Operation

The A5/A3 System is a pneumatically-driven and electronically-controlled anesthesia machine. Three types of supply gases are available: N₂O, O₂, and Air. The user adjusts supply gas flows through the flowmeters. The mixed gas outputted from the flowmeters is further mixed with the anesthetic agent inside the anesthetic vaporizer to form the fresh gas.

During the inspiratory phase, the microprocessor-controlled inspiratory valve produces the preset drive gas inspiratory flow and the expiratory valve closes. The drive gas enters the bellows inside the dome and depresses the bellows inside the dome to move downward. This forces the gas inside the bellows to enter the patient's lungs until the end of the inspiratory phase.

During the expiratory phase, the inspiratory valve closes and the expiratory valve opens. The patient can expire freely. The patient's expired gas, mixed with the fresh gas, enters and lifts the bellows inside the dome. The drive gas outside the bellows is scavenged to the Anesthetic Gas Scavenging System (AGSS) until the end of the expiratory phase.

During ventilation, the ventilator performs real-time monitoring over airway pressure and flow. If the airway pressure or minute volume is outside the user-preset alarm limits, an audible and visible alarm occurs. When the airway pressure is higher than the limit value determined by the PEAK high alarm limit, the ventilator enters the expiratory phase automatically to avoid causing injury to the patient. Additionally, the ventilator has a built-in pressure safety valve that opens at an approximate pressure of 110 cmH₂O (11 kPa).

7.2 Block Diagram

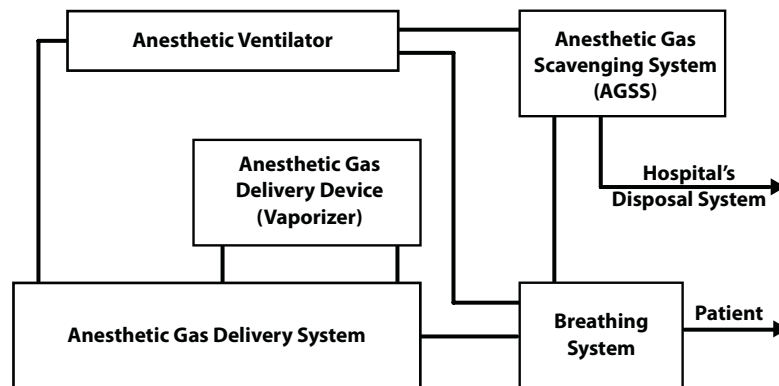

FIGURE 7-1 Block Diagram of A5/A3 System

7.3 Maintenance Schedule

The schedules listed in TABLE 7-1 are the minimum frequency based on 2000 hours of usage per year. The equipment should be serviced more frequently if used more than this yearly usage. Maintenance should be performed by a trained technician.

NOTE: During cleaning and setup, inspect the parts and seals for damage. Replace or repair as necessary.

MINIMUM FREQUENCY	MAINTENANCE
Daily	Clean the external surfaces.
Every 72 hours	Perform 21% O ₂ calibration (O ₂ sensor in breathing system). The A5/A3 will prompt the user for 21% O ₂ calibration (only for units with an galvanic O ₂ cell).
Annually	Periodic maintenance due, to be performed by a trained technician. Gas Bench calibration. Contact Mindray Technical Support for details.
Every three years	Periodic maintenance due, to be performed by a trained technician. Contact Mindray Technical Support for details.
As necessary	<ul style="list-style-type: none"> • Perform 100% O₂ calibration after replacing the O₂ sensor. • Replace the O₂ sensor if it cannot be calibrated. • Before installing the cylinder, use a new cylinder gasket on the cylinder yoke. • Empty the water trap if there is water buildup. • Replace the soda lime in the canister if soda lime color change is detected. Follow the manufacturer's instructions. • Replace the flow sensor if the seal for the flow sensor is damaged, the membrane inside the flow sensor is cracked or distorted, or the flow sensor is cracked or distorted. • Calibrate the flow sensor after re-installing the cleaned or disinfected flow sensor, after replacing with a new flow sensor, or when tidal volume measurement is inaccurate. • Replace the waste gas transfer tube if it is damaged. • Inspect the O₂ flush button for normal movement. If not, refer to the service manual for the disassembling and cleaning.

TABLE 7-1 Maintenance Schedule

7.4 Breathing System Maintenance

When cleaning the breathing system, replace any parts that are visibly cracked, chipped, distorted or worn. For details, refer to "Inspect the System" on page 4-3 and "Cleaning and Disinfection" on page 7-11.

7.5 Flow Sensor Calibration

WARNING: Do not perform calibration while the unit is connected to a patient.

NOTE: During calibration, do not operate the pneumatic parts. Do not move or press the breathing tubes.

NOTE: Calibrate the flow sensor after re-installing the cleaned or disinfected flow sensor, after replacing with a new flow sensor, or when tidal volume measurement is inaccurate.

The flow sensor must be calibrated whenever the flow volume is out of specification or after changing the flow sensor.

To calibrate the flow sensor:

1. Ensure that the supply gas pressure is normal.
2. Turn off all fresh gas inputs.
3. Set the ventilation switch to the automatic ventilation position.
4. Remove the bellows and reinstall the bellows housing.
5. Plug the Y-piece of the breathing circuit into the leak test port to close the breathing system.
6. Remove the water trap.
7. Ensure that the system is in **Standby** mode. If not, select the **End Case** button in the **Manual** tab and follow the screen prompts to end the case and enter **Standby** mode.
8. Select the **Setup** softkey, then the **Calibrate Flow Sensor** button.
9. Follow the on-screen prompts and select the **Begin** button to start to calibrate the flow sensor (see FIGURE 7-2). The calibration process takes several minutes. The system will display the results of the calibration status when the process is completed.
10. Reinstall the bellows and water trap.
11. Select **Done** to close the **Calibration** window (see FIGURE 7-3).
12. Select the **Accept** or **Cancel** softkey to close the **Setup** window.

NOTE: In case of repeated calibration failure, contact Mindray Technical Support.

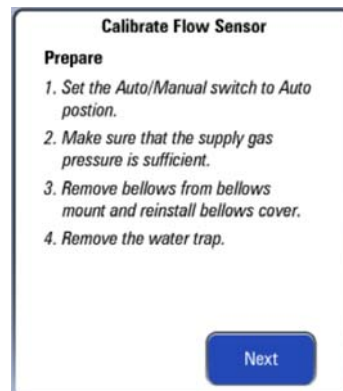

FIGURE 7-2 Flow Sensor Calibration Begin

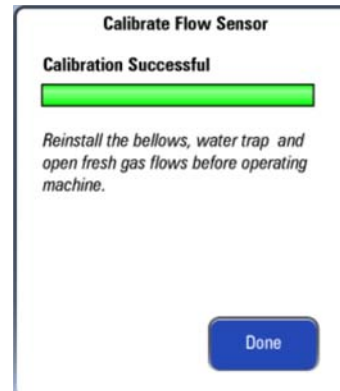

FIGURE 7-3 Flow Sensor Calibration Successful

7.6 O₂ Sensor Calibration

Perform O₂ calibration when the measured value of O₂ concentration has a large deviation from other reference sources or when the O₂ sensor is replaced. If the O₂ sensor is replaced, 100 % O₂ sensor calibration is required.

For continued O₂ sensor accuracy, the A5/A3 checks for 21 % O₂ calibration approximately every 72 hours. The A5/A3 prompts the user for 21 % O₂ calibration as follows:

- When the machine is powered on, if more than 72 hours have elapsed since the last successful calibration, the prompt message "Calibrate O₂ sensor for 21 %" is displayed. The message disappears after successful calibration.
- If the machine is kept powered on, the prompt message "Calibrate O₂ sensor for 21 %" is displayed at the next **Standby** mode after 5 AM after 72 hours have elapsed since the last successful calibration.

NOTE: If the alarm message "RT Clock Needs Battery" or "RT Clock Failure" is displayed, the prompt message "Calibrate O₂ sensor for 21 %" is disabled.

The O₂ sensor must be removed from the breathing system before calibrating it at 21 %. The O₂ sensor can be reinstalled after verifying that there is no water build-up in the O₂ sensor and its installation part.

7.6.1 Calibrate the O₂ Sensor

21 % O₂ sensor calibration can be performed in all ventilation modes when calibrating from the **Setup > General** tab. When calibrating from the **Setup > System** tab, the A5/A3 must be placed in **Standby** mode and a system password is required. See “System Tab” on page 3-38 for password information.

NOTE: The breathing system automatically seals off the O₂ sensor port when the O₂ sensor is removed.

1. Set the A5/A3 to **Standby** mode:
 - a. Set the **Auto/Manual** ventilation switch to **Manual**.
 - b. Turn off all fresh gas flows by turning their knobs clockwise. Wait until all fresh gas flow levels are effectively at 0.0 L/min (i.e., flow < 0.05 L/min).
 - c. Select the **End Case** button in the **Manual** tab.

NOTE: The A5/A3 system will not allow the **End Case** button to be selected until the **Auto/Manual** ventilation switch is set to **Manual**, and system detects the individual fresh gas flows are effectively turned off (i.e., flow < 0.05 L/min).

- d. Follow the screen prompts to end the case and enter **Standby** mode.
2. Select **Setup > General > Calibrate O₂ Sensor**.
Only 21 % O₂ sensor calibration is available in the **General** tab,

or

Select **Setup > System** (system password needed) > **Calibration > O₂ Sensor**. Both 21 % and 100 % O₂ sensor calibrations are available in the **System** tab. The **21 %** button is highlighted by default.

NOTE: In the **System** tab, 21 % oxygen sensor calibration must be completed before performing 100 % calibration. The 100 % button is disabled if a 21 % oxygen sensor calibration has not been successfully completed within 72 hours.

3. Remove the O₂ sensor from the O₂ sensor port on the breathing system. Allow three (3) minutes for the sensor to acclimate to the environment.
4. Carefully follow the on-screen prompts to prepare for calibration.
5. Select the **Begin** button to start 21 % O₂ sensor calibration. The system will indicate the calibration status when the process is completed.
6. When 21 % O₂ sensor calibration is successfully completed, reinstall the O₂ sensor into the O₂ sensor port on the breathing system. If an error code in red (e.g., 00 00 00 10) is displayed, see TABLE 7-2, “O₂ Sensor Calibration Error Codes,” on page 7-8 for troubleshooting information.
7. If you are in the **Setup > General**, select **Done** when 21 % O₂ sensor calibration is completed. Skip the remaining steps below.

or

If you are in the **Setup > System** and wish to skip 100 % O₂ sensor calibration, select **Done** to close the calibration window. Skip the remaining steps below.

8. Select the **100 %** button to perform 100 % O₂ sensor calibration.
9. Carefully follow the on-screen prompts to prepare for calibration.

10. Select the **Begin** button to start 100 % O₂ sensor calibration. The system will indicate the calibration status when the process is completed. If an error code in red (e.g., 00 00 00 10) is displayed, see TABLE 7-2, "O₂ Sensor Calibration Error Codes," on page 7-8 for troubleshooting information.

11. After calibration, select **Done** to close the calibration window.

NOTE: **In case of repeated calibration failures, replace the O₂ sensor and repeat the calibration. If calibration still fails, contact Mindray Technical Support.**

ERROR CODE	DESCRIPTION	RECOMMENDED ACTION
00 00 00 01	O ₂ sensor calibration is canceled.	. Perform O ₂ sensor calibration again.
00 00 00 02	O ₂ supply pressure is low. During 100 % calibration process, O ₂ supply pressure was not sufficient.	. Check that the O ₂ sensor is connected to the cable correctly. . Check the O ₂ supply pressure. . Check that the O ₂ sensor output voltage in the calibration menu is steady. . Replace the O ₂ sensor.
00 00 00 04	O ₂ sensor is disconnected. Sampled data is greater than 2900 (AD value).	. Check that the O ₂ sensor is connected to the cable correctly. . Check that the O ₂ sensor output voltage in the calibration menu is steady. . Replace the O ₂ sensor.
00 00 00 08	21 % calibration value is outside of the expected range (150~500) (AD value).	. Check that the O ₂ sensor is connected to the cable correctly. . Check that the O ₂ sensor is in 21 % O ₂ . . Check that the O ₂ sensor output voltage in the calibration menu is steady. . Replace the O ₂ sensor.
00 00 00 10	100 % calibration value is outside of the expected range (800~2028) (AD value).	. Check that the O ₂ sensor is connected to the cable correctly. . Check that the O ₂ sensor is in 100 % O ₂ . . Check that the O ₂ sensor output voltage in the calibration menu is steady. . Replace the O ₂ sensor.
00 00 00 20	Error writing to EEPROM.	. Repeat the calibration. . Replace the O ₂ sensor. . Replace the CPU board.

TABLE 7-2 O₂ Sensor Calibration Error Codes

NOTE: **The error code can be a combination of 2 codes e.g. 00 00 00 18 is 00 00 10 and 00 00 00 08.**

7.7 Water Build-up in the Flow Sensor

7.7.1 Prevent Water Build-up

Water comes from the condensation of exhaled gas and a chemical reaction between CO₂ and the soda lime in the CO₂ absorbent canister. At lower fresh gas flows more water builds up because of the following:

- Less gas in the breathing system is removed through AGSS and gets replaced with fresh gas.
- More CO₂ stays in the CO₂ absorbent canister to react and produce water.
- More moist, exhaled gas stays in the breathing system and CO₂ absorbent canister to produce condensed water.

Check the inspiratory and expiratory flow sensors when abnormal flow waveform or unstable tidal volume fluctuation is detected. Check the sensor for water. If there is water build-up, clear it immediately before use.

To prevent water build-up:

- Use a filter between the flow sensor and the patient to limit water condensation in the flow sensor.
- Check the water trap for water before using the A5/A3 Anesthesia System. If there is water build-up, clear it immediately.

7.7.2 Clear Water Build-up

The water build-up inside the flow sensor will result in inaccurate measured value of tidal volume. If there is water built up inside the flow sensor, remove the sensor and clear the water. Then reinstall the sensor for use.

WARNING: Check water build-up inside the flow sensor before every system use. Accumulated water in the flow sensor causes erroneous readings.

WARNING: Ensure that all breathing system parts are completely dried after the breathing system is cleaned and disinfected.

7.8 AGSS Transfer Tube Maintenance

Check the tube of the AGSS transfer system. Replace it if it is damaged.

7.9 Electrical Safety Inspection

NOTE: Perform electrical safety inspection after servicing or routine maintenance. Before the electrical safety inspection, make sure all the covers, panels, and screws are correctly installed.

NOTE: The electrical safety inspection should be performed once a year.

7.9.1 Auxiliary Electrical Outlet Test

Verify the mains voltage is present at each auxiliary outlet when the A5/A3 is connected with power.

7.9.2 Electrical Safety Inspection Test

- 1.** Perform protective earth resistance test:
 - a.** Plug the probes of the analyzer into the protective earth terminal and equipotential terminal of the AC power cord.
 - b.** Test the earth resistance with a current of 25 A.
 - c.** Verify the resistance is less than 0.1 ohms (100 mohms).
 - d.** Plug the probes of the analyzer into the protective earth terminal of the AC power cord and the protective earth terminal of any auxiliary outlet. Repeat steps b and c.
 - e.** If the resistance is larger than 0.1 ohms (100 mohms) but less than 0.2 ohms (200 mohms), disconnect the AC power cord and plug the probe that is previously plugged in the protective earth terminal of the AC power cord into the protective earth contact of the power outlet. Repeat steps a to d.
- 2.** Perform the following earth leakage current tests:
 - normal polarity;
 - reverse polarity;
 - normal polarity with open neutral; and
 - reverse polarity with open neutral.
- 3.** Verify the maximum leakage current does not exceed 300 μ A (0.3 mA) in the first two tests. While for the last two tests, verify that the maximum leakage current does not exceed 1000 μ A (1 mA).

NOTE: **Make sure the safety analyzer is authorized by certificate organizations (UL, CSA, or AAMI etc.). Follow the instructions of the analyzer manufacturer.**

7.10 Cleaning and Disinfection

CAUTION: Before using the A5/A3 System (after cleaning or disinfecting), power up the system and follow the on-screen prompts to perform the leak test and the compliance test. (see section 4.5 (page 4-9) "Leak and Compliance Tests".)

CAUTION: To prevent system damage:

- Refer to the literature supplied by the manufacturer of the cleaning agent.
- Never use organic, halogenated or petroleum-based solvents, anesthetics, glass cleaning agents, acetone or other irritant agents.
- Never use abrasive agents (i.e. steel wool or silver polish) to clean components.
- Keep all liquids away from electronic components.
- Prevent liquid from entering the equipment.
- All cleaning solutions used must have a pH between 7.0 and 10.5.
- Do not use Cavacide: Cavacide is known to cause degradation of plastic polymers.
- Do not use Oxicide: May cause discoloration of device hardware.

7.10.1 General Guidelines

Follow all WARNINGS and CAUTIONS listed at the beginning of this chapter. Prior to use, refer to the facility's infection control policy to determine the frequency and level at which cleaning and disinfection should be performed. If disinfection is required, all components must first be cleaned and dried as described in the following sub-sections. For additional information about infection control practices, refer to the *APIC Guidelines for Selection and Use of Disinfectants*, published in the American Journal of Infection Control, Vol. 24, No. 4, August 1996.

For additional information about infection control, refer to the ASA's Recommendations for Infection Control for the Practice of Anesthesiology, second edition. For additional information on reprocessing medical devices, refer to AAMI TIR 30:2003, A compendium of process, materials, test methods, and acceptance criteria for cleaning reusable medical devices.

7.10.2 Cleaning and Disinfecting Agents / Autoclaving

The A5/A3 should be cleaned and disinfected before its first use, then daily and as often as needed. (see TABLE 7-1, "Maintenance Schedule," on page 7-4.)

TABLE 7-3 lists the cleaning and disinfecting agents and autoclaving process that may be used on the A5/A3 Anesthesia System.

AGENT	CLASSIFICATION
Water	Cleaning agent
Green soap tincture	Cleaning agent
Sodium hypochlorite solution, 10 % available chlorine	Disinfecting agent
Isopropyl alcohol (70 %)	Disinfecting agent

* All breathing system components are autoclavable except the PAW gauge, flow sensor, O₂ sensor, and bellows. The components can be autoclaved up to a maximum temperature of 134 °C (273 °F).

TABLE 7-3 Cleaning and Disinfecting Agents

AGENT	CLASSIFICATION
Super Sani-Cloth (0.5 % Quaternary ammonium chloride and 55% Isopropyl alcohol)	Disinfecting agent
Cidex (Only for bellows, Inspiratory Pressure Gauge and Ins/Exp Flow sensors)	Disinfecting agent
ALPET D2 Surface sanitizer wipes	Disinfecting agent
Viraguard surface disinfectant towelette	Disinfecting agent
Autoclaving process *	Autoclaving

* All breathing system components are autoclavable except the PAW gauge, flow sensor, O₂ sensor, and bellows. The components can be autoclaved up to a maximum temperature of 134 °C (273 °F).

TABLE 7-3 Cleaning and Disinfecting Agents

7.10.3 External Surfaces

Use a soft cloth with an approved cleaning agent (see section 7.10.2 (page 7-11) "Cleaning and Disinfecting Agents / Autoclaving") to clean all outer surfaces, hoses, and cables.

7.10.4 Bellows Assembly



FIGURE 7-4 Bellows Assembly

Read all content in this section before disassembling, cleaning, disinfecting, and re-assembling the bellows to avoid equipment malfunction and patient injury.

1. The bellows dome is a transparent cover with graduation marks from 300 to 1500 ml. Remove the bellows dome by turning it counterclockwise and lifting it away from the breathing system. (see FIGURE 7-5)



FIGURE 7-5 Removing the Bellows Dome

2. Detach the bellows from the base plate (see FIGURE 7-6).



FIGURE 7-6 Detaching the Bellows

3. Detach the top plate from the bellows (see FIGURE 7-7).



FIGURE 7-7 Detaching the Bellows Top Plate

4. Remove the bellows adapter ring from inside the bellows (see FIGURE 7-8). Note the orientation of the bellows adapter ring as it is being removed to ensure that it is properly inserted during reassembly. (If the ring contains grooves, the ring should be oriented so that the grooves are facing downward in the final reassembly.)



Grooves on adapter ring face downward.

FIGURE 7-8 Removing the Bellows Adapter Ring

5. Remove the bellows dome O-ring as shown in FIGURE 7-9.

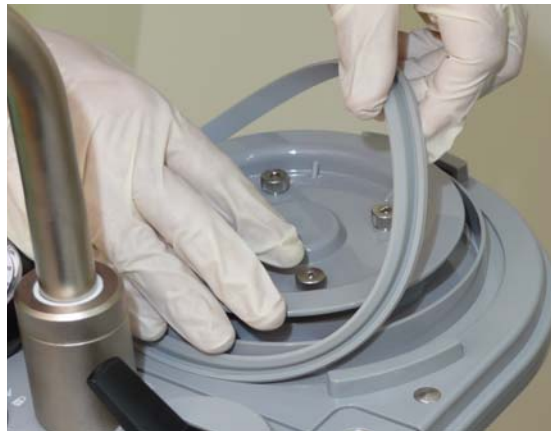

FIGURE 7-9 Removing the Bellows Dome O-ring

6. Cleaning

- a. To prevent damage, wash each component gently using a recommended cleaning agent (see section 7.10.2 (page 7-11) "Cleaning and Disinfecting Agents / Autoclaving"). Ensure that all bellows surfaces are cleaned. Do not autoclave the bellows.
- b. Rinse with clean, hot water, and allow to dry.

NOTE: Dry the bellows by allowing it to hang so that it is fully expanded. This will facilitate thorough drying and prevent it from sticking to itself.

CAUTION: Do not autoclave the following components: Paw gauge, oxygen sensor, flow sensor, and bellows. These components cannot withstand immersion or the heat and pressure of autoclaving.

CAUTION: If moisture remains in the bellows after cleaning, the bellows surface folds may become tacky and prevent the bellows from properly expanding. Ensure all moisture is removed from the bellows after cleaning.

- c. After all bellows components are completely dry, inspect them for damage before disinfection or re-assembly and functional testing.
- d. If disinfecting the bellows components, continue with step 7, otherwise skip to step 8.

7. Disinfection

NOTE: Ensure that all bellows components have been cleaned as described in step 6 before disinfecting.

See section 7.10.2 (page 7-11) "Cleaning and Disinfecting Agents / Autoclaving" and use an approved disinfecting agent for all bellows components while adhering to facility policies and procedures.

- 8. Connect the bellows to the breathing system by reassembling all components in the reverse order. Prior to use after cleaning or disinfecting, power up the system and follow the on-screen prompts to perform the leak test and the compliance test (see section 4.5 (page 4-9) "Leak and Compliance Tests").

7.10.5 Inspiration and Expiration Valves

The following procedure is written generically for a single, unspecified valve. It should be performed on both the inspiration and expiration valves.



FIGURE 7-10 Location of Expiration and Inspiration Valves

- 1. Remove the valve dome (see FIGURE 7-11), turning it counterclockwise.



FIGURE 7-11 Valve Dome Removal

CAUTION: The valve disc in each of the inhalation and exhalation valve assemblies on the breathing system is fragile and must be handled with care while removing the valve cage from the valve assembly.

2. Remove the valve cage (see FIGURE 7-12). The six prongs of the valve cage have tabs that secure cage onto the valve assembly. While noting the previous **CAUTION**, use two hands to remove the valve cage by gently manipulating the prongs to release the tabs. As the valve cage is lifted away from the assembly, ensure that the valve disc does not fall out.
3. Remove the valve disc from the valve cage (see FIGURE 7-12).
4. Remove the O-ring from the bottom of the valve assembly (see FIGURE 7-12).

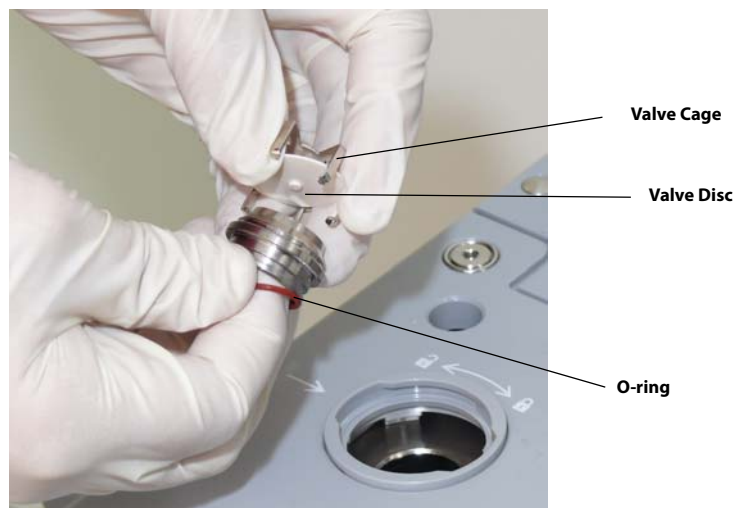

FIGURE 7-12 Valve Cage Removal

CAUTION: The valve disc in each of the inhalation and exhalation valve assemblies on the breathing system is fragile and must be handled with care while removing the valve cage from the valve assembly.

5. Cleaning

- a.** Wash each component using a recommended cleaning agent (see section 7.10.2 (page 7-11) "Cleaning and Disinfecting Agents / Autoclaving").
- b.** Rinse with clean, hot water, and allow to dry.
- c.** After all components are completely dry, verify that the valve disc and the prongs of the valve cage are undamaged before disinfection or re-assembly and functional testing.
- d.** If disinfecting the valve components, continue with step 6, otherwise skip to step .

6. Disinfection

NOTE: **Ensure that all valve components have been cleaned as described in step 5 before disinfecting.**

See section 7.10.2 (page 7-11) "Cleaning and Disinfecting Agents / Autoclaving" and use an approved disinfecting agent for all valve components while adhering to facility policies and procedures.

7. Reassembly

Reassemble the valve components in the reverse order, noting any previously stated **CAUTION**. Prior to use after cleaning or disinfecting, power up the system and follow the on-screen prompts to perform the leak test and the compliance test (see section 4.5 (page 4-9) "Leak and Compliance Tests").

7.10.6 Oxygen Sensor

1. During use, the oxygen sensor is plugged firmly into the breathing system block. It is not necessary to remove this component to clean it. However, if removal is desired, first disconnect the oxygen sensor cable from the main unit (see FIGURE 7-13). Then hold the oxygen sensor and pull straight out firmly from the breathing system block



FIGURE 7-13 Oxygen Sensor and Cable

CAUTION: Never immerse the oxygen sensor or its connector in any type of liquid.

- Dispose of the oxygen sensor as per the local regulations.

CAUTION: Do not wash the inner surface of the oxygen sensor.

CAUTION: Do not autoclave the following components: Paw gauge, oxygen sensor, flow sensor, and bellows. These components cannot withstand immersion or the heat and pressure of autoclaving.

2. Clean the oxygen sensor exterior with a soft, lint-free cloth, and a recommended cleaning agent (see section 7.10.2 (page 7-11) "Cleaning and Disinfecting Agents / Autoclaving"). Allow to dry thoroughly.
3. Inspect the oxygen sensor for damage and replace as necessary.
4. Re-insert the oxygen sensor if it had been removed.

7.10.7 APL Valve

1. The APL valve is a component that is plugged into position and secured by a threaded base collar. Loosen the base collar of the APL valve by turning the collar (not the valve knob) counterclockwise until it is no longer threaded (see FIGURE 7-14). Then, firmly pull the APL valve upward to remove.

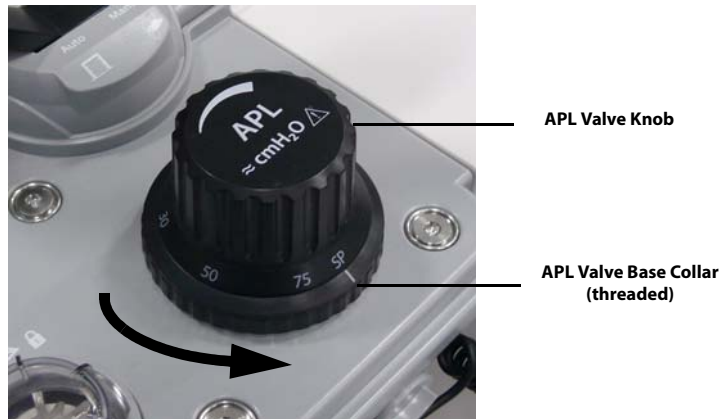

FIGURE 7-14 APL Valve Removal

2. Cleaning

- a. Clean the APL valve with a soft, lint-free cloth and a recommended cleaning agent (see section 7.10.2 (page 7-11) "Cleaning and Disinfecting Agents / Autoclaving"). Allow it to dry thoroughly.
- b. If disinfecting the APL valve, continue with step 3, otherwise skip to step 4.

3. Disinfection

NOTE: Ensure that the APL valve has been cleaned as described in step 2 before disinfecting.

See section 7.10.2 (page 7-11) "Cleaning and Disinfecting Agents / Autoclaving" and use an approved disinfecting agent for the APL valve while adhering to facility policies and procedures.

4. Reassemble the APL valve by turning its base collar clockwise until it is securely tightened. Prior to use after cleaning or disinfecting, power up the system and follow the on-screen prompts to perform the leak test and the compliance test (see section 4.5 (page 4-9) "Leak and Compliance Tests").

7.10.8 PAW Gauge

1. The PAW gauge is a component that is plugged into position for use. It is not necessary to remove this component to clean it. However, if removal is desired, simply hold it and lift it straight up from the breathing system block (see FIGURE 7-15).



FIGURE 7-15 PAW Gauge Removal

CAUTION: Do not autoclave the following components: Paw gauge, oxygen sensor, flow sensor, and bellows. These components cannot withstand immersion or the heat and pressure of autoclaving.

2. Clean the PAW gauge with a soft, lint-free cloth and a recommended cleaning agent (see section 7.10.2 (page 7-11) "Cleaning and Disinfecting Agents / Autoclaving"). Allow it to dry thoroughly.
3. Re-insert the PAW gauge if it was removed. Prior to use after cleaning or disinfecting, power up the system and follow the on-screen prompts to perform the leak test and the compliance test (see section 4.5 (page 4-9) "Leak and Compliance Tests").

7.10.9 Bag Arm

1. At the base of the bag arm, locate the retaining ring. Turn the ring counterclockwise until it is no longer threaded. Lift the bag arm from the breathing system block (see FIGURE 7-16).

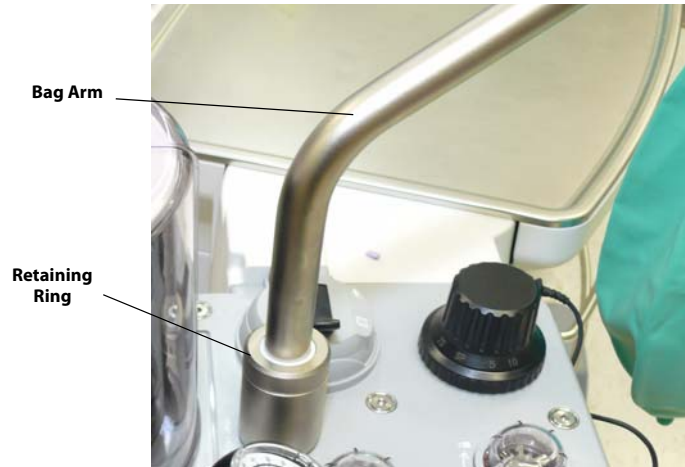

FIGURE 7-16 Bag Arm Removal

2. Cleaning

- a. Clean the bag arm with a soft, lint-free cloth and a recommended cleaning agent (see section 7.10.2 (page 7-11) "Cleaning and Disinfecting Agents / Autoclaving"). Allow it to dry thoroughly.
- b. If disinfecting the bag arm, continue with step 3, otherwise skip to step 4.

3. Disinfection

NOTE: Ensure that the bag arm has been cleaned as described in step 2 before disinfecting.

See section 7.10.2 (page 7-11) "Cleaning and Disinfecting Agents / Autoclaving" and use an approved disinfecting agent for the bag arm while adhering to facility policies and procedures.

4. Reassemble the bag arm to the breathing system. Prior to use after cleaning or disinfecting, power up the system and follow the on-screen prompts to perform the leak test and the compliance test (see section 4.5 (page 4-9) "Leak and Compliance Tests").

7.10.10 Absorber Canister

1. Locate the condensate drain valve at the bottom of the absorber canister assembly.

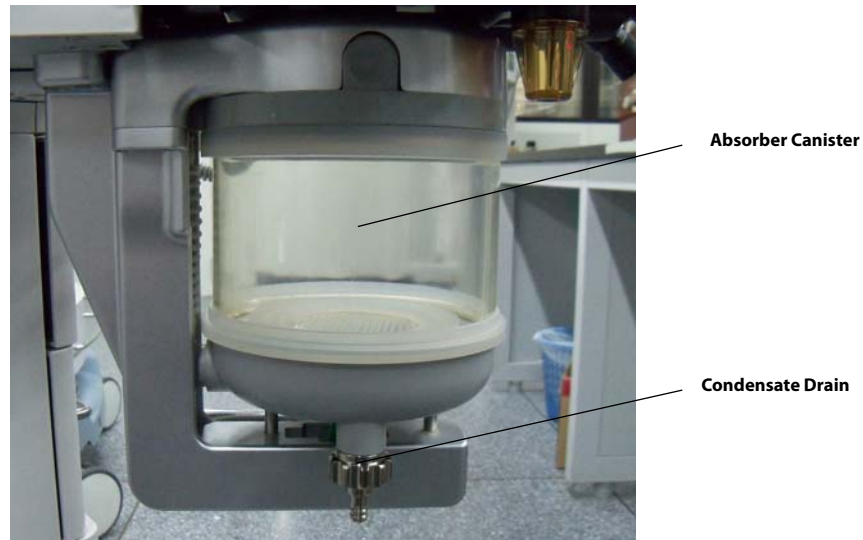

FIGURE 7-17 Condensate Drain Valve Location

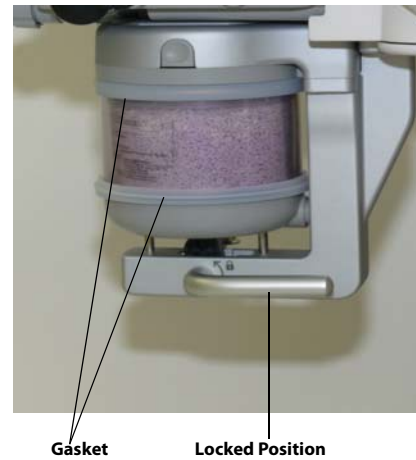

FIGURE 7-18 Condensate Drain Valve (Close Up View)

2. While holding a small cup below the drain, turn the condensate drain valve clockwise to open the drain and collect any water that may have gathered. Turn the drain valve counter-clockwise to close the drain. Discard any water collected.

WARNING: Use extreme care while handling the absorbent as it contains a caustic irritant.

3. Rotate the locking mechanism handle clockwise into the unlocked position (see FIGURE 7-19). This separates the absorber canister from the top of the assembly. While noting the previous **WARNING**, remove the absorber canister. Then remove the Pre-Pak or loose fill absorbent from the canisters. Dispose of the absorbent as per the local regulations.

**FIGURE 7-19** Absorber Canister, Unlocked**FIGURE 7-20** Absorber Canister, Locked

4. Cleaning

- a. Clean the absorber canister with a soft, lint-free cloth and a recommended cleaning agent (see section 7.10.2 (page 7-11) "Cleaning and Disinfecting Agents / Autoclaving"). Allow them to dry thoroughly.
- b. If disinfecting the absorber canister, continue with step 5, otherwise skip to step 6.

5. Disinfection

NOTE: **Ensure that the absorber canister has been cleaned as described in step 4 before disinfecting.**

See section 7.10.2 (page 7-11) "Cleaning and Disinfecting Agents / Autoclaving" and use an approved disinfecting agent for the absorber canister while adhering to facility policies and procedures.

6. Make sure that the gasket is correctly installed. The comparison between correct installation and incorrect installation is shown below.

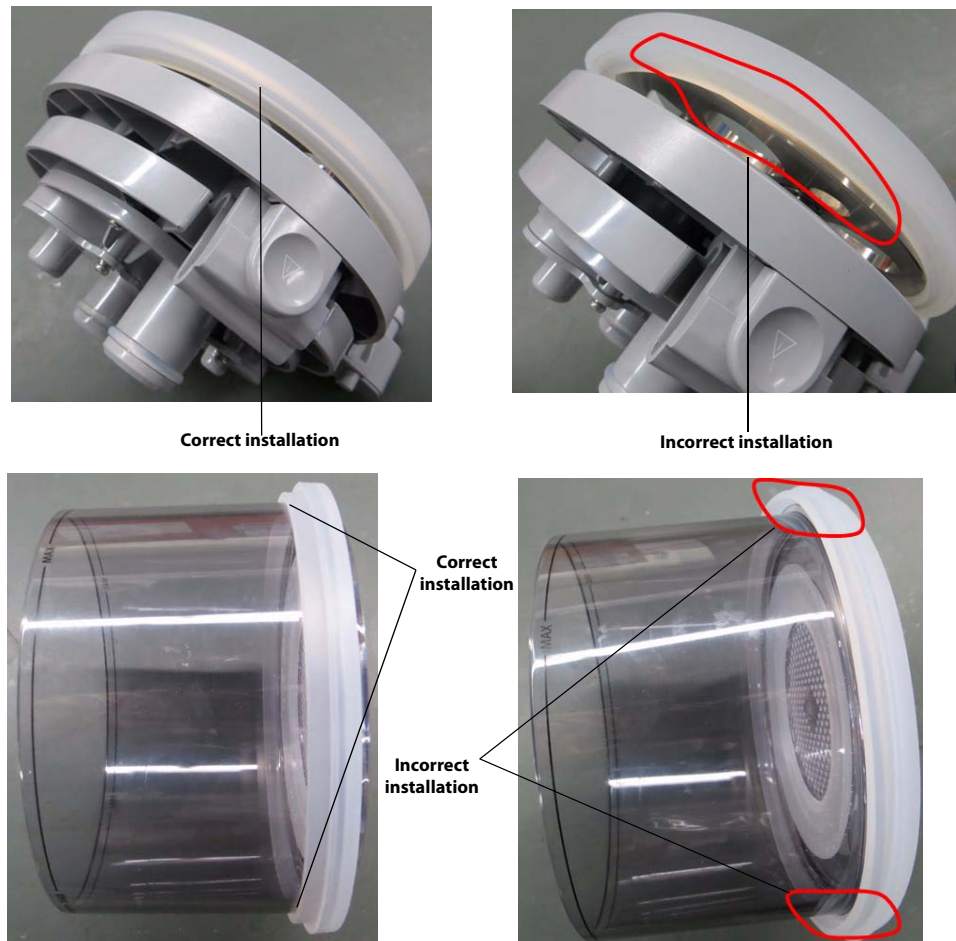

FIGURE 7-21 Gasket installation

WARNING: Use extreme care while handling the absorbent as it contains a caustic irritant.

WARNING: Check if the gasket is properly installed in place while installing the absorber canister. If the gasket is not properly installed (for example, gasket is not evenly seated and centered) it may cause breathing system leakage.

WARNING: Ensure that the absorber canister is completely dry before adding absorbent.

7. While noting the previous **WARNING**, add new Pre-Pak or loose fill absorbent to the absorber canister. Re-install the absorber canister into the assembly. Rotate the locking mechanism handle clockwise into the locked position (see FIGURE 7-20). Prior to use after cleaning or disinfecting, power up the system and follow the on-screen prompts to perform the leak test and the compliance test (see section 4.5 (page 4-9) "Leak and Compliance Tests").

7.10.11 Breathing System Block

1. Remove all of the following components from the breathing system block:
 - Bellows Assembly
 - Oxygen Sensor
 - Inspiratory and Expiratory Valves (all components)
 - APL Valve
 - PAW Gauge
 - Bag Arm
 - Absorber Canister
 - Inspiratory and Expiratory Flow Sensors
2. Remove the absorber canister (see section 7.10.10 (page 7-22) "Absorber Canister").
3. Press and hold the buckle on the bypass assembly to take out the bypass assembly downward.



FIGURE 7-22 Remove Bypass Assembly

4. Pull out the canister bottom plate upward.



FIGURE 7-23 Remove Canister Bottom Plate

CAUTION: Use care in lifting and manipulating the breathing system block during removal from its mounting arm as handling may be awkward due to its weight and shape.

CAUTION: The breathing system block is calibrated and matched with the anesthesia machine at the factory. A label in the back of the machine indicates the serial number of the matching breathing system block. When reassembling, ensure that the breathing system block and anesthesia machine are properly matched. Otherwise, the breathing system must be recalibrated.

5. While holding the sides of the breathing system block, firmly separate and slide it away from its mounting arm.

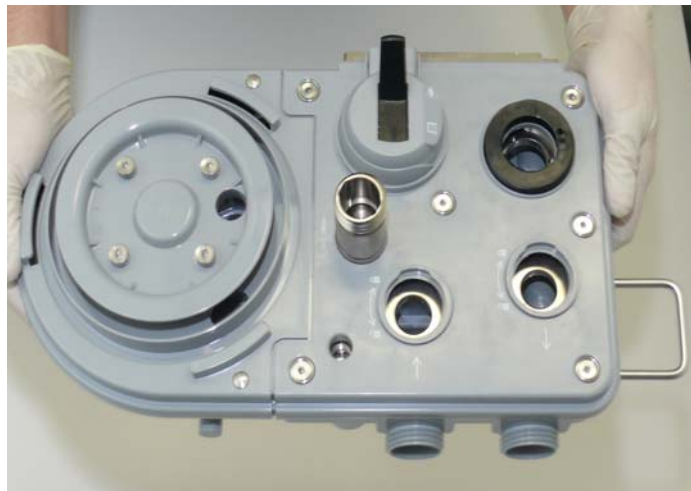

FIGURE 7-24 Breathing System Block Removal, Top View

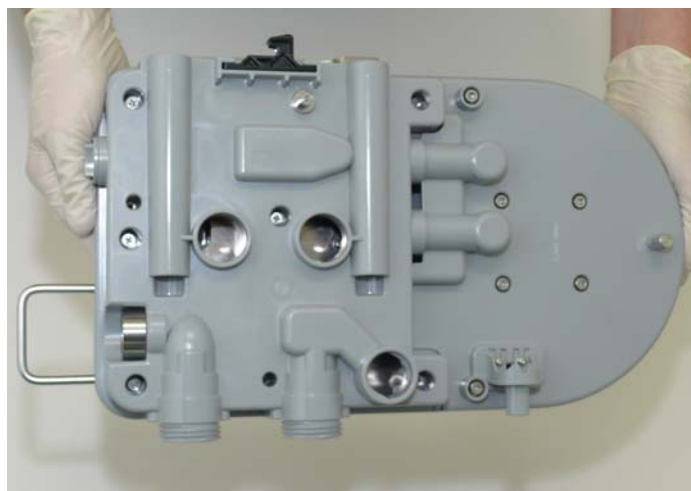

FIGURE 7-25 Breathing System Block Removal, Bottom View

6. Cleaning

- a.** Clean the breathing system block exterior with a soft, lint-free cloth and a recommended cleaning agent (see section 7.10.2 (page 7-11) "Cleaning and Disinfecting Agents / Autoclaving"). Allow to dry thoroughly.
- b.** If disinfecting the breathing system block, continue with step 7, otherwise skip to step 8.

7. Disinfection

NOTE: **Ensure that the breathing system block has been cleaned as described in step 6 before disinfecting. High level disinfection of the breathing system block can be performed through steam autoclaving up to a maximum temperature of 134 °C (273 °F).**

Using an autoclave, follow the manufacturer's instructions for high level disinfection of the breathing system block while adhering to facility policies and procedures.

- 8.** Reassemble the breathing system components in reverse order. Prior to use after cleaning or disinfecting, power up the system and follow the on-screen prompts to perform the leak test and the compliance test (see section 4.5 (page 4-9) "Leak and Compliance Tests").

CAUTION: **To ensure patient safety, use only parts and accessories specified in this manual.**

CAUTION: **To ensure measurement accuracy and to avoid possible damage to the A5/A3, use only Mindray-approved cables and accessories.**

CAUTION: **Inspiratory and expiratory flow sensors are flow-direction-sensitive.**

7.10.12 Active AGSS (Anesthetic Gas Scavenging System) and AGSS Transfer Hose

1. Disconnect the EVAC hose from the AGSS (see FIGURE 7-26).
2. Remove the AGSS and Transfer Hose from the A5/A3.

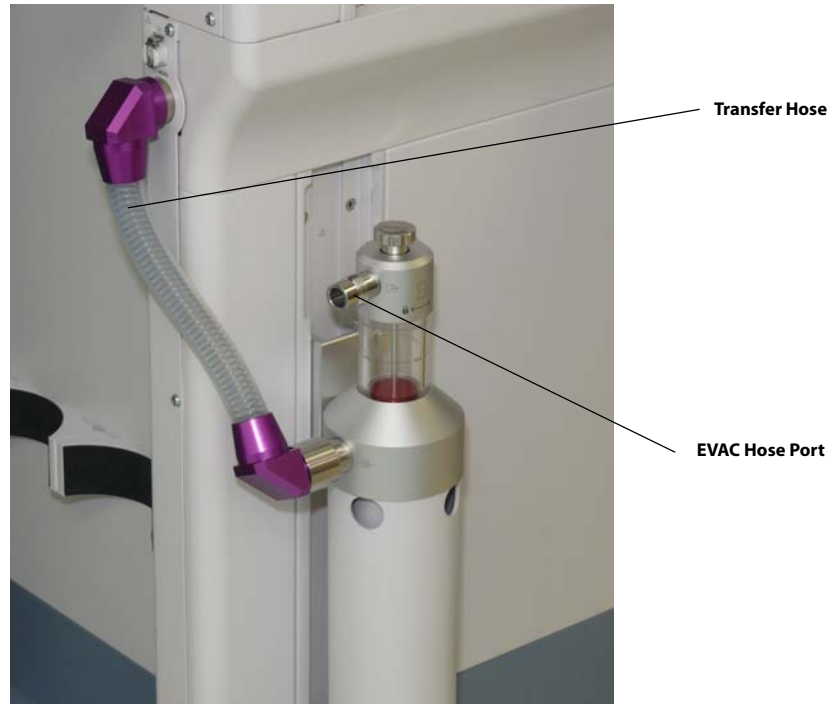

FIGURE 7-26 AGSS and Transfer Hose Removal

3. Clean the outer surface of the AGSS and Transfer Hose with a soft, lint-free cloth and a recommended cleaning agent (see section 7.10.2 (page 7-11) "Cleaning and Disinfecting Agents / Autoclaving"). Allow to dry thoroughly.
4. Remove the top of the AGSS (see FIGURE 7-27). Inspect the AGSS filter and shake it over a waste container to clean it as necessary. If the filter must be replaced, dispose of the old filter per local disposal regulations.



FIGURE 7-27 Removal of AGSS Top / AGSS Filter Inspection

5. Reassemble the AGSS and Transfer Hose and reconnect them to the A5/A3 in the reverse order.

7.11 Regular Maintenance

WARNING: To avoid endangering a patient, do not perform testing or maintenance when the machine is in use.

Visual inspection should be performed every 30 days to ensure timely replacement of worn or damaged parts.

1. Power off the system.
2. Perform an overall visual inspection of the system.
3. Power up the system and follow the on-screen prompts to perform the leak test and the compliance test (see section 4.5 (page 4-9) "Leak and Compliance Tests").

AG and O₂ Concentration Monitoring (Optional)

Introduction	8-2
Understand MAC Values.....	8-3
Identify External AG Modules.....	8-4
Prepare to Measure AG.....	8-6
Make AG Settings.....	8-6
Measurement Limitations	8-8
Troubleshooting.....	8-8
Scavenge the Sample Gas.....	8-9
Calibrate the AG Module	8-10

8.1 Introduction

The Anaesthetic Gas (AG) module measures the patient's anesthetic and respiratory gases, and incorporates the features of the O₂ module as well.

The AG (anesthesia gas) module determines the concentrations of certain gases using the infrared (IR) light absorption measurement. The gases that can be measured by the AG module absorb IR light. Each gas has its own absorption characteristic. The gas is transported into a sample cell, and an optical IR filter selects a specific band of IR light to pass through the gas. For multiple gas measurement, there are multiple IR filters. This means that higher concentration of IR absorbing gas causes a lower transmission of IR light. The amount of IR light transmitted after it has been passed through an IR absorbing gas is measured. From the amount of IR light measured, the concentration of gas present can be calculated.

Oxygen does not absorb IR light as other breathing gases and is therefore measured relying on its paramagnetic properties. Inside the O₂ sensor are two nitrogen-filled glass spheres mounted on a strong rare metal taut-band suspension. This assembly is suspended in a symmetrical non-uniform magnetic field. In the presence of paramagnetic oxygen, the glass spheres are pushed further away from the strongest part of the magnetic field. The strength of the torque acting on the suspension is proportional to the oxygen concentration. From the strength of the torque, the concentration of oxygen is calculated.

The measurement provides:

1. An EtCO₂ waveform;
2. Measured parameters: O₂, EtCO₂, FiCO₂, EtN₂O, FiN₂O, EtAA, FiAA and MAC,

where, AA stands for any of the five anesthetic agents: Des (desflurane), Iso (isoflurane), Enf (enflurane), Sev (sevoflurane), or Hal (halothane).

8.2 Understand MAC Values

Minimum alveolar concentration (hereinafter referred to as MAC) can be displayed on the screen when the anesthesia system is configured with an external AG module.

MAC is a basic index indicating the depth of inhaled anesthesia. The ISO 80601-2-55 defines MAC as follows: alveolar concentration of an inhaled anesthetic agent that, in the absence of other anesthetic agents and at equilibrium, prevents 50% of subjects from moving in response to a standard surgical stimulus.

The following table lists 1 MAC of various inhaled anesthetic agents.

Anesthetic agent	Des	Iso	Enf	Sev	Hal	N ₂ O
1 MAC	6.0%	1.15%	1.7%	2.1%	0.77%	105%*

* 1 MAC nitrous oxide can only be reached in a hyperbaric chamber.

TABLE 8-1 1 MAC of various inhaled anesthetic agents

NOTE: The data shown in this table is from ISO 80601-2-55, which are published by the U.S. Food and Drug Administration for a healthy 40-year-old male patient.

NOTE: In actual applications, although the A5 accounts for patient age, the effects of weight and other factors on the inhaled anesthetic agent should be considered.

When one or more than one anesthetic agents are used, the formula for calculating MAC is:

$$MAC = \sum_{i=0}^{N-1} \frac{EtAgent_i}{AgentVol_{age}i}$$

Where, N stands for the number of all anesthetic agents (including N₂O) which the AG module can measure, EtAgent_i for the concentration of end-tidal anesthetic agent and AgentVol_{age}_i for the 1MAC value corresponding to the anesthetic agent after age correction.

The formula for calculating age correction of 1MAC is:

$$MAC_{age} = MAC_{40} \times 10^{(-0.00269 \times (age-40))}$$

NOTE: The formula above is only suitable for patients who are older than one year old. If the patient is less than one year old, the system will use one year to do age correction.

For example, for a 60-year-old patient, if the AG module detects 0.9% Iso and 50% N₂O in the patient end-tidal mixed gas, the 1MAC of Iso is 1.01% and 1MAC of N₂O is 92.7% of the 60-year-old patient based on the above age correction formula. The MAC value is calculated as follows:

$$MAC = \frac{0.9\%}{1.01\%} + \frac{50\%}{92.7\%} = 1.4$$

8.3 Identify External AG Modules



FIGURE 8-1 External AG Module

NOTE: The AG module (see FIGURE 8-1) is configured with the function of compensating barometric pressure automatically.

NOTE: The hardkey on the AG module has been disabled.

8.4 Prepare to Measure AG

1. Select the appropriate watertrap according to patient type and attach it to the watertrap socket.
2. Connect one end of the gas sampling tube to the watertrap.
3. Connect the other end of the gas sampling tube to the patient via the airway adapter.
4. Connect the exhaust tube to the gas outlet on the module to scavenge the sample gas to the waste gas disposal system.

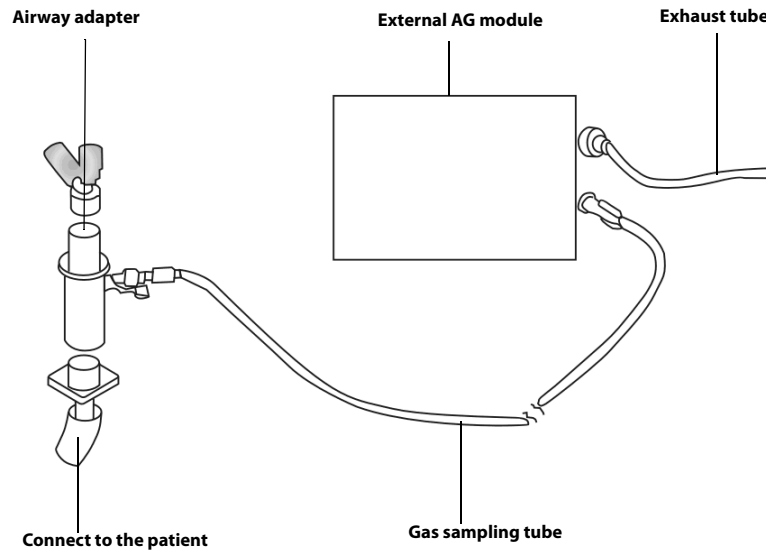

FIGURE 8-2 Prepare to Measure AG

- CAUTION:** Position the airway adapter properly so that the part connecting to the gas sampling tube is pointing upwards. This prevents condensed water from entering the gas sampling tube and causing an occlusion as a result.
- CAUTION:** The watertrap collects water drops condensed in the sampling tube and therefore prevents them from entering the module. If the collected water reaches a certain amount, you should drain it to avoid airway blockage.
- CAUTION:** The watertrap has a filter preventing bacterium, vapor and patient secretions from entering the module. After long-term use, dust or other substances may compromise the performance of the filter or even block the airway. In this case, replace the watertrap. Replacing the watertrap once a month is recommended.
- WARNING:** Do not use high volume watertraps with Infant patients. Otherwise, patient injury could result.
- WARNING:** Make sure that all connections are reliable. Any leak in the system can result in erroneous readings due to patient breathing gas mixed with ambient air.

8.5 Make AG Settings

Perform the settings below when the anesthesia system is configured with an external AG module.

8.5.1 Set CO₂ Unit

To change the CO₂ Unit:

1. Select **Setup** softkey > **System** tab.
2. Select the **CO₂ Unit** button.
3. Choose between **mmHg**, **kPa** and **%**.
4. Select the **Accept** button to confirm the change.

8.5.2 Set CO₂ Placement

To change the CO₂ Placement:

1. Select **Setup** softkey > **Display** tab.
2. Select the **CO₂ Placement** button.
3. Choose between **TOP** and **Bottom**.
4. Select the **Accept** button to confirm the change.

8.5.3 Set CO₂ Scale

To change the CO₂ Scale:

1. Select **Setup** softkey > **Display** tab.
2. Select the **CO₂ Scale** button.
3. Choose between **0-40**, **0-60** and **0-80**.
4. Select the **Accept** button to confirm the change.

8.5.4 Gas Bench Flow Rate

To change the Gas Bench Flow Rate:

1. Select **Setup** softkey > **General** tab.
2. Select the **Gas Bench Flow Rate** button.
3. Choose between **High** (recommended), **Med** and **Low**, as follows:
High: 200 ml/min for high volume watertrap; 120 ml/min for low volume watertrap
Med: 150 ml/min for high volume watertrap; 90 ml/min for low volume watertrap
Low: 120 ml/min for high volume watertrap; 70 ml/min for low volume watertrap
4. Select the **Accept** button to confirm the change.

8.5.5 Set Alarm Limits

Users can set the high and low alarm limits of N₂O, CO₂, and Agents to create alarm conditions consistent with patient needs. The alarm is then triggered when the parameter value is greater than the High Limit or lesser than the Low Limit.

NOTE: When using the A5 Anesthesia System, ensure that the alarm limits of each parameter are set to the appropriate values for the patient.

To set the Alarm Limits:

1. On the main screen, select the **Alarms** softkey.
The **Alarms** window is displayed.
2. Select the **Limits** tab (see FIGURE 6-8) or **Agents** tab (see FIGURE 8-3).
3. Select a parameter softkey.
The softkey is highlighted when selected.
4. Use the on-screen keypad to enter the desired parameter value.
For each parameter, the range of values is displayed above the keypad.
5. Optionally, to restore the default values, select the "Load Alarm Defaults" button. This restores the high and low values for the parameters to the user default values.
6. Select the **Accept** to save the change (or select **Cancel** to not save).
7. Repeat Steps 3 to 6 for each parameter value.

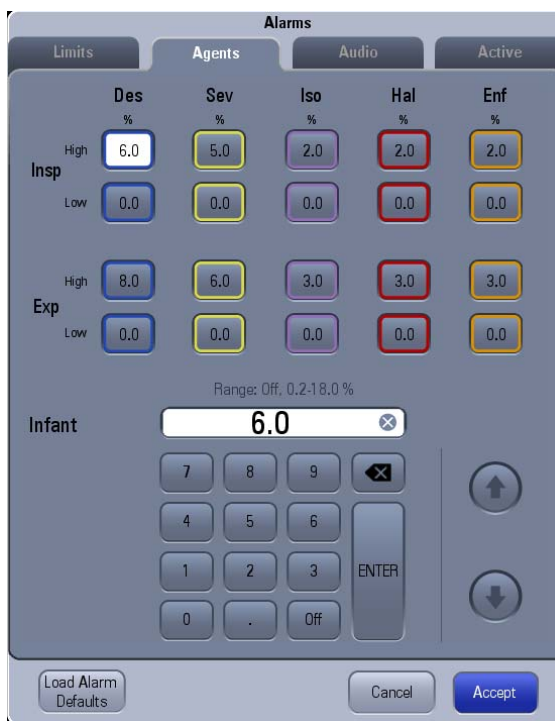

FIGURE 8-3 Agents Tab

8.6 Measurement Limitations

Measurement accuracy may degrade due to:

- Leakage or internal leakage of the sample gas
- Mechanical shock
- Humidity or condensate
- Cyclic pressure which is greater than 10 kPa (100 cmH₂O)
- Other interference source (if available)

NOTE: Gas data is reported as zero if the measured concentration is below the defined threshold level during more than 3 s: CO₂ - 0.1/0.3%; N₂O - 3/3%; O₂ - 0/0%, Agents - 0.15/0.3% (Full/ISO accuracy).

NOTE: Inaccuracy is specified at 10-55 °C operating temperature and default compensated for an H₂O partial pressure of 11 mBar (i.e. 22 °C @40% RH ambient conditions) and using a DRYLINE™ sampling system. Any other ambient H₂O partial pressure will dilute the gas sample to a different extent, causing a measurement error. Under typical operating conditions this effect is negligible. An increase of the ambient H₂O partial pressure to 30 mBar (i.e. 28 °C @80% RH or 33 °C @60% RH) will cause a general error for all measured gases of -2%_{REL}. For automatic compensation of the ambient humidity effect on the gas sample composition, the actual ambient H₂O partial pressure can be input to AION™ from the host via the communication interface.

8.7 Troubleshooting

If the gas inlet (including watertrap, sampling tube and airway adapter) is occluded by condensed water, airway occlusion will be prompted on the screen.

To remove the occlusion:

- Check the airway adapter for occlusion and replace if necessary.
- Check the sampling tube for occlusion or kinking and replace if necessary.
- Check the watertrap for water build-up. Empty the watertrap. If necessary, replace the watertrap.

If that does not resolve it, internal occlusions may exist. Contact your service personnel.

If the expired O₂ concentration is higher than the inspired O₂ concentration, it is possible that the pump rate is too low. Setting **Gas Bench Flow Rate** to **High** is recommended.

8.8 Scavenge the Sample Gas



Metal clip

Exhaust tube

To scavenge the sample gas to the waste gas disposal system, depress the metal clip and then plug the exhaust tube to the sample gas return port marked **A.** ← as shown in the above picture.

WARNING: When using the AG module to perform AG measurements on the patients who are receiving or have recently received anesthetic agents, connect the outlet to the sample gas return port to prevent the medical staff from breathing in the anesthetic agents.

8.9 Calibrate the AG Module

Prepare the following before doing the calibration:

- Gas cylinder, with a certain standard gas or mixture gas. Gas concentration should meet the following requirements: AA \geq 1.5%, CO₂ \geq 1.5%, N₂O \geq 40%, O₂ \geq 40%, of which AA represents an anesthetic agent. $a/c \leq 0.01$ (a is the gas absolute concentration accuracy; c is the gas concentration).
- T-shape connector
- Tubing

Follow this procedure to perform a calibration:

1. Connect the test system as follows.

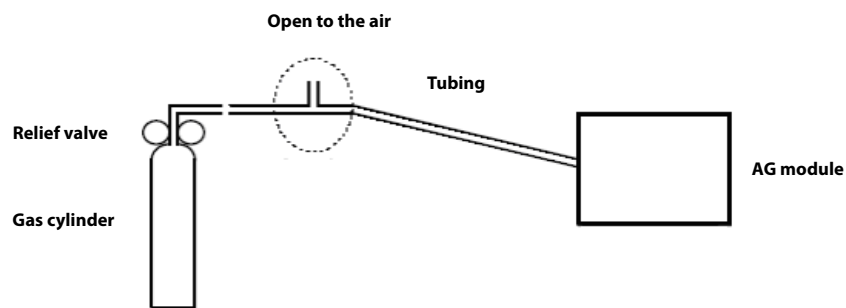

2. Ensure that the system is in **Standby** mode. If not, select the **End Case** button in the **Manual** tab and follow the on-screen prompts to end the case and enter **Standby** mode.
3. Select the **Setup** softkey > **System** tab (system password needed).
4. Select the **Calibration** button.
5. Select the **External AG Module** button.
6. Wait for the AG module to be completely warmed up
7. Enter the actual concentration of the calibration gas.
8. Turn on the calibration gas canister. The system displays the real-time concentration of calibration gas.
9. Select the **Calibrate** button to start to calibrate the AG Module. The system will display the results of the calibration status when the process is completed.
10. After calibration, select **Done** to close the **Calibration** window.
11. Select **Accept** to close the **Setup** window.

Product Specifications

Standards Compliance	9-2
Safety Designations.....	9-4
Physical Specifications	9-5
Stability Configurations and Conditions	9-5
Environmental Specifications.....	9-6
Electrical Specifications.....	9-7
Pneumatic Specifications.....	9-9
Breathing System Specifications	9-11
Anesthetic Gas Scavenging System (AGSS)	9-14
Monitor Module.....	9-14
Ventilator Specifications	9-18
Displays and Controls Specifications	9-20
Alarms	9-22
Safety Specifications	9-23
ASTM F 1208 – 89 (2005) Disclosures.....	9-24
Data Storage (Non-Volatile) and Recording	9-25
Electromagnetic Compatibility	9-26

9.1 Standards Compliance

The A5/A3 Anesthesia System is in compliance with the following industry standards.

ISO 10993-1: 2009	Biological Evaluation of Medical Devices - Part 1: Evaluation and Testing
ISO 15223-1: 2012	Medical Devices - Symbols to be used with Medical Device labels, labelling and information to be supplied
ASTM F1101-90 (2003)	Standard Specification for Ventilators Intended for Use During Anesthesia
CGA V-1: 2005	Standard for Compressed Gas Cylinder Valves Outlet and Inlet Connections
CGA V-5: 2008	Diameter-Index Safety System (Non-interchangeable Low Pressure Connections for Medical Gas Applications
IEC 60068-2-27: 2008/EN 60068-2-27: 2009	Basic Environmental Testing Procedures. Part 2 Tests - Tes Ea and Guidance: Shock
IEC 60068-2-64: 2008/EN 60068-2-64: 2008	Environmental Testing: Part 2: Test Methods, Test Fh: Vibration, Broad-band Random (Digital Control) and Guidance
ANSI / AAMI ES60601-1:2005/(R)2012 and C1:2009/(R)2012 and, A2:2010/(R)2012 (consolidated text)	Medical electrical equipment - Part 1: General requirements for basic safety and essential performance
IEC 60601-1-2: 2007	Medical Electrical Equipment - Part 1-2: General Requirements for Basic Safety and Essential Performance - Collateral Standard: Electromagnetic Compatibility - Requirements and Tests
IEC 60601-1-8: 2006	Collateral Standard: General Requirements, Tests and Guidance for Alarm Systems in Medical Electrical Equipment and Medical Electrical Systems
ISO 80601-2-13:2011	Medical electrical equipment —Part 2-13: Particular requirements for basic safety and essential performance of an anaesthetic workstation
IEC 62304: 2006	Medical Device Software - Software Life Cycle Processes
IEC 62366: 2007	Medical Devices - Application of Usability Engineering to Medical Devices
ISO 14971: 2007	Medical Devices - Application of Risk Management to Medical Devices
ISO 80601-2-55:2011	Medical electrical equipment - Part 2-55: Particular requirements for the basic safety and essential performance of respiratory gas monitors
ISO 5356-1: 2004	Anaesthetic and Respiratory Equipment - Conical Connectors - Part 1: Cones and Sockets

TABLE 9-1 Standards Compliance

The anesthesia workstation shall be used together with the monitoring devices, alarm system and protective devices below:

- The pressure measurement device in compliance with ISO 80601-2-13;
- The pressure restriction device in compliance with ISO 80601-2-13;
- The expiratory volume monitor in compliance with ISO 80601-2-13;
- The breathing system with alarm system in compliance with ISO 80601-2-13;
- The anaesthetic vapour delivery system in compliance with ISO 80601-2-13;
- The anaesthetic gas scavenging system in compliance with ISO 80601-2-13;
- The anesthetic gas delivery device in compliance with ISO 80601-2-13;
- The anesthetic ventilator in compliance with ISO 80601-2-13;
- The O₂ monitor in compliance with ISO 80601-2-55;
- The CO₂ monitor in compliance with ISO 80601-2-55;
- The AG monitor in compliance with ISO 80601-2-55.

The anesthesia workstation is integrated with the pressure measurement device, pressure restriction device, expiratory volume monitor, anaesthetic breathing system with alarm system, anaesthetic gas delivery system, anaesthetic vapour delivery system, anaesthetic ventilator, optional anesthetic gas (AG) monitor and O₂ monitor in compliance with the afore mentioned standards, where:

- The pressure restriction device, expiratory volume monitor and breathing system with alarm system also comply with ISO 80601-2-13.
- AG monitor in compliance with ISO 80601-2-55.
- O₂ monitor in compliance with ISO 80601-2-55.

9.2 Safety Designations

Type of Protection against Electric Shock:	Class I equipment with internal electric power supply. Where the integrity of the external protective earth (ground) in the installation or its conductors is in doubt, the equipment shall be operated from its internal electric power supply (i.e., battery supply).
Degree of Protection against Electric Shock:	BF, defibrillation-proof
Power Supply Connection:	External electric power supply: 100 to 120 VAC, 60 Hz, 12 A Internal battery supply: Lithium-ion, 11.1 V, 4.5 Ah (1 or 2 batteries installed)
Mode of Operation:	Continuous
Degree of Protection against Hazards of Explosion:	Ordinary equipment, without protection against explosion; not for use with flammable anesthetics.
Degree of Protection against Harmful Ingress of Water:	Protection against vertically falling water drops - IPX1 (IEC 60529)
Electrical Connection between Equipment and Patient:	Equipment designed for non-electrical connection to the patient
Degree of Mobility:	Mobile: including the base and casters of the anesthesia system
Disinfection:	Steam autoclavable or disinfectable

TABLE 9-2 Safety Designations

9.2.1 Oxygen Enriched Environments

The A5/A3 complies with the standards for oxygen-enriched environments by staying below the required power threshold or by providing forced ventilation and ventilation failure monitoring and alarm.

9.2.2 Wiring and PC Board Materials

The A5/A3 complies with NRTL standards for wiring and PC board materials. Primary wiring is double insulated (jacketed). All wires are UL recognized.

9.3 Physical Specifications

Dimensions:	Height: 1400 mm \pm 25 mm Width: 1050 mm \pm 25 mm (including breathing system) Depth: 805 mm \pm 25 mm
Weight (no vaporizers or gas cylinders):	A3: 150 kg (331 lbs) \pm 5 kg A5: 160 kg (353 lbs) \pm 5 kg
Work Surface (stainless steel):	Width: 616 mm (24.3 in) \pm 25 mm Depth: 380 mm (15.0 in) \pm 25 mm Height: 850 mm (33.5 in) \pm 25 mm
Top Shelf:	Weight Capacity: 40 kg (88.2 lbs) Width: 616 mm (24.3 in) \pm 25 mm Depth: 362 mm (14.3 in) \pm 25 mm
Side Mounting Rails:	Supporting weight: 25 kg at a maximum distance of 0.41 m
Bag Arm:	Fixed Height Bag Arm: Length: 312 mm \pm 10 mm Height: 1150 mm \pm 10 mm Swiveling angle: 150 \pm 10 degrees Flexible Bag Arm: Length: 550mm \pm 10mm The height and angle of the flexible bag arm can be adjusted freely.
Drawers (internal dimensions):	Drawers are of equal size: • Height: 135 mm \pm 10 mm • Width: 440 mm \pm 10 mm • Depth: 385 mm \pm 10 mm
Casters:	Diameter: 15 cm (6 in) Brake: • A5 model: central brake with lock/unlock indicator • A3 model: individual caster brakes Cable pusher: cable pusher with each caster
Handle	Length: 650 mm \pm 25 mm

TABLE 9-3 Physical Specifications

9.4 Stability Configurations and Conditions

Maintains stability when tilted 10 degrees, as required by IEC 60601-1, clause 9.4.

WARNING: Due to the size and weight of the A5/A3, it should only be moved by qualified personnel.

WARNING: To avoid tip hazards, use care when moving the A5/A3 up or down inclines, around corners and across thresholds. Remove all equipment from the top shelf and mounted to the side of the A5/A3 before moving. Do not attempt to roll the A5/A3 over hoses, cords or other obstacles.

9.5 Environmental Specifications

Operating Temperature:	+10 to +40°C +50 to 104°F
Storage Temperature:	-20 to +60°C -4 to 140°F oxygen sensor: -20 to +50°C
Humidity (Operating and Storage):	15 to 90% RH, non-condensing
Atmospheric Pressure (Operating):	70 kPa to 106.7 kPa
Atmospheric Pressure (Storage):	50 kPa to 106.7 kPa
Resistance to Ingress of Water:	Complies with the requirements of clause 11.6.3 in IEC 60601-1 and also the requirements in IEC 60529 for protection against vertically falling water drops (IPX1)

TABLE 9-4 Environmental Specifications

9.6 Electrical Specifications

9.6.1 Main Electrical Power Specifications

The A5/A3 complies with IEC 60601-1 for its main power supply.

Power Supply Input Voltage:	100 to 120 VAC @ 60 Hz
Power Supply Input Current:	12 A maximum for A5 unit 10 A maximum for A5 auxiliary outlets 12 A maximum for A3 unit 9 A maximum for A3 auxiliary outlets
Power Cord:	5 ± 0.05 m (length), hospital grade

TABLE 9-5 Main Electrical Power Specifications

9.6.2 Battery Power Specifications

Battery Type:	Sealed Lithium-ion, 11.1 V, 4.5 Ah A5: two (2) batteries A3: one (1) battery
Battery Run-time:	One (1) new battery installed: > 75 minutes Two (2) new batteries installed: > 150 minutes Run-time criteria: VCV mode (Tv = 500 ml, Rate = 10 bpm, I:E = 1:2, Plimit = 30 cmH ₂ O, PEEP = OFF)
Time to Shutdown from Lower Battery Alarm:	> 5 minutes (new fully-charged battery supply)
Battery Charge Time:	New Battery: < 8 hours from an initial charge of 10 % Charging occurs whenever AC is applied to the A5/A3 System.

TABLE 9-6 Battery Power Specifications

9.6.3 Auxiliary Electrical Outlets

Number of Outlets:	A5: 4 A3: 3
Output Voltage:	100 to 120 VAC @ 60 Hz (corresponds to power supply input voltage)
Output Current of Each Auxiliary Outlet:	3 A
Output Current Total:	A5: 10 A A3: 9 A
Breaker Rating per Auxiliary Outlet:	3 A
Breaker Rating Total:	A5: 10 A A3: No total current breaker

TABLE 9-7 Auxiliary Electrical Outlets

9.6.4 Communication Ports

Communication Port (SP1):	One DB9 male connector on the rear of the A5/A3. Provides a non-isolated output serial RS232C interface.
	CAUTION: Do not connect any non-isolated devices to the DB9/RS232C interface of the A5/A3.
Network Port (CS1):	One RJ-45 network port
SB Ports (SB1, SB2):	Two SB ports
	CAUTION: Do not connect any devices to the SB ports other than Mindray approved USB storage devices and a supported USB mouse (see "Networking and USB Storage" on page A-4).
Data Port (DP1):	One test port for connection of calibration equipment by a Mindray-authorized service representative

TABLE 9-8 Communication Ports

9.7 Pneumatic Specifications

9.7.1 Pipeline Supply (N₂O, Air, O₂)

Pipeline Input Pressure Range:	N ₂ O: 280 to 600 kPa (40 to 87 psi) Air: 280 to 600 kPa (40 to 87 psi) O ₂ : 280 to 600 kPa (40 to 87 psi)
Pipeline Input Flow Rate Range:	O ₂ : Max. 190 L/min (Including maximum drive gas flow rate, maximum flow rate to seal PEEP valve, maximum O ₂ Flow meter and maximum O ₂ flush) Air: Max. 20 L/min N ₂ O: Max. 20 L/min
Pipeline Connections:	DISS threaded body as per CGA V-5
Gas Configuration:	N ₂ O, Air, O ₂

TABLE 9-9 Pipeline Supply

9.7.2 Cylinder Supply (N₂O, Air, O₂)

Cylinder Supply:	E-cylinder (American style) and pin indexed per CGA V-1
O₂ Cylinder Input Pressure Range:	6.9 to 15.5 MPa (1000 to 2250 psi)
N₂O Cylinder Input Pressure Range:	4.2 to 6 MPa (600 to 870 psi)
Air Cylinder Input Pressure Range:	6.9 to 15.5 MPa (1000 to 2250 psi)
Cylinder Input Flow Rate Range:	O ₂ : Max. 190 L/min (Including maximum drive gas flow rate, maximum flow rate to seal PEEP valve, maximum O ₂ Flow meter and maximum O ₂ flush) Air: Max. 20 L/min N ₂ O: Max. 20 L/min
Cylinder Connections:	Pin-Index Safety System (PISS)
Yoke Configuration:	N ₂ O, Air, O ₂

TABLE 9-10 Cylinder Supply

9.7.3 Vaporizer Connections

Vaporizer Positions:	Two vaporizer mount or three vaporizer mount.
Vaporizer Parking Mount:	Inactive, for storage only (A5 only)
Mounting Mode:	Selectatec, with interlocking function (Selectatec® is registered trademark of Datex-Ohmeda Inc.)

TABLE 9-11 Vaporizer Connections

9.7.4 Drive Gas

O₂

9.7.5 N₂O Automatic Cutoff

An N₂O automatic cutoff stops the flow of N₂O when O₂ flow is less than 200 ml/min.

9.7.6 O₂ Controls

O₂ supply failure alarm: 185.5 to 254.5 kPa (27 to 36 psi)

9.7.7 Oxygen Ratio Controller

Provides 25 % \pm 4 % O₂ when N₂O valve is fully open and O₂ flow range is 0.8 L/min to 3 L/min

9.8 Breathing System Specifications

9.8.1 Breathing System Volume

Automatic Ventilation:	Total volume: 4350 ml +/-100 ml (including bellows) Bellows: 1500 ml +/-100 ml
Manual Ventilation:	3300 ml +/-100 ml (not including breathing bag)

TABLE 9-12 Breathing System Volume

9.8.2 CO₂ Absorber Assembly

Absorber Capacity:	1 Pre-Pak (1500 ± 100 ml)
Absorber Canister Contents:	1 Pre-Pak canister or Loose Fill absorbent

TABLE 9-13 CO₂ Absorber Assembly

9.8.3 Water Trap

Mode:	Detachable separately
Capacity:	6 ± 1 ml

TABLE 9-14 Water Trap

9.8.4 Breathing System Connections

Exhalation Connection:	22 mm OD ISO 15 mm ID ISO Taper
Inhalation Connection:	22 mm OD ISO 15 mm ID ISO Taper
Connections from Breathing System to a Gas Scavenger:	30 mm OD ISO

TABLE 9-15 Breathing System Connections

9.8.5 APL Valve

Range:	SP, Approximately 0 to 75 cmH ₂ O
Adjustable Range of Motion:	330 ± 10 degrees
Tactile Knob Indication:	30 cmH ₂ O and above
Minimum pressure to open the APL valve:	Dry: 0.1 kPa Wet: 0.1 kPa

TABLE 9-16 APL Valve

Resistance of APL valve in dry gas:

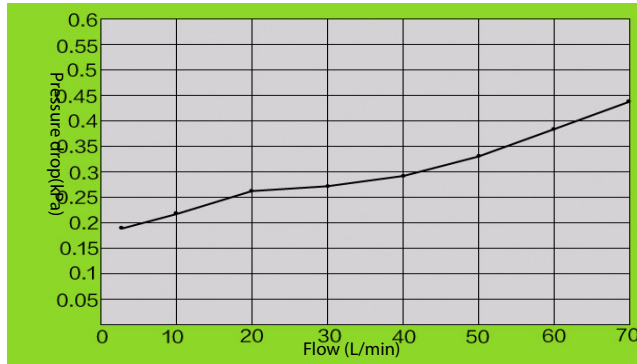

Resistance of APL valve in wet gas:

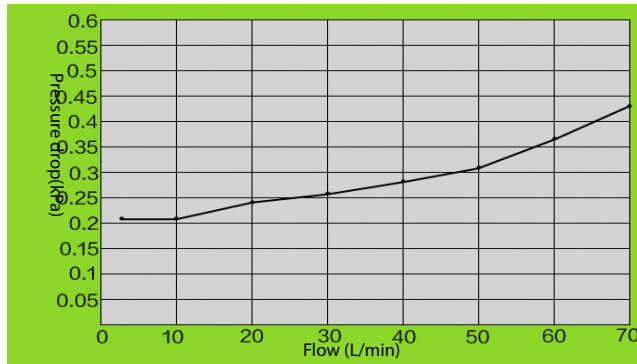

TABLE 9-16 APL Valve

9.8.6 Resistance

Expiratory resistance:

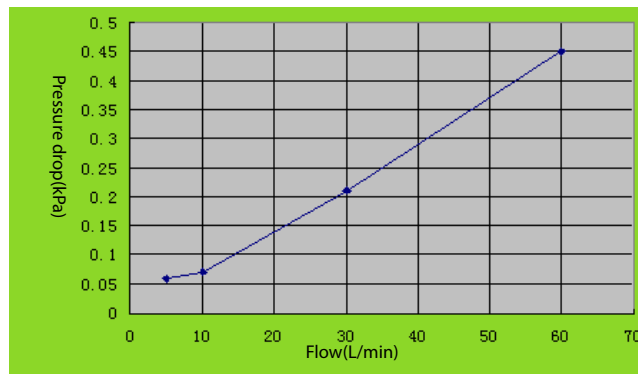

TABLE 9-17 Resistance

Inspiratory resistance:

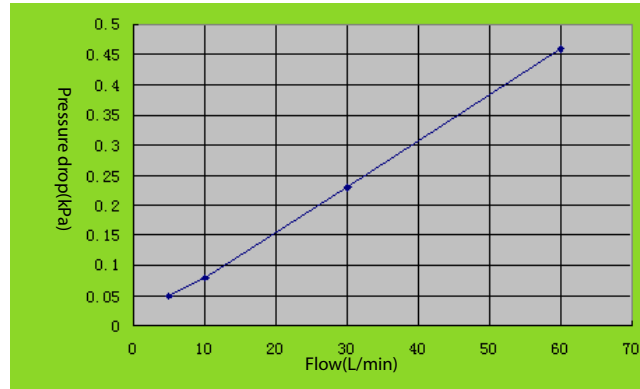

TABLE 9-17 Resistance

9.8.7 Breathing System Temperature Controller

Breathing System Temperature Maintained to:	35°C typical at 20°C ambient temperature
--	--

Note: The block heater does not operate while the system is being powered by the internal battery supply.

TABLE 9-18 Breathing System Temperature Controller

9.8.8 Breathing Circuit Parameters

System Compliance:	Volume of gas lost due to internal compliance (manual ventilation mode only): ≤ 2 ml/cm H ₂ O
Internal Compliance:	≤ 4 ml/cm H ₂ O
Impedance in Manual Mode:	≤ 6 cmH ₂ O (the gas under test is a bi-directional sine wave at a frequency of 20 with tidal volume of 1 L)
Impedance in Automatic Ventilation Mode:	≤ 6 cmH ₂ O (the gas under test is a semi-sine wave at a frequency of 20 with tidal volume of 1 L)
Leakage:	≤ 150 ml @ 3 kPa
System Safety Pressure on Patient Circuit:	110 ± 10 cmH ₂ O @ 10 to 10 L/min

TABLE 9-19 Breathing Circuit Parameters

9.8.9 Materials

All materials in contact with the patient’s exhaled gas are autoclavable, except the flow sensors, pressure gauge, bellows, and O₂ cell. All materials in contact with the patient’s gas comply with ISO 10993-1, ISO 10993-5, ISO 10993-10.

9.9 Anesthetic Gas Scavenging System (AGSS)

Type of the Applicable Disposable System:	Low flow
Size:	430 mm x 132 mm x 114 mm Tolerance: +/- 5 mm
Weight	2.15 kg +/- 0.05 kg
Extract Flow:	25 to 50 L/min
Resistance:	≤ 0.35 kPa @ 75 L/min

TABLE 9-20 Anesthetic Gas Scavenging System (AGSS)

9.10 Monitor Module

9.10.1 AG Module

Measurement mode:	Sidestream
Warm-up time:	ISO accuracy mode: < 45 s Full accuracy mode: < 10 min
Sampling rate:	Sampling rate: 120/150/200 ml/min: High Volume AG Watertrap 70/90/120 ml/min: Low Volume AG Watertrap Accuracy: ± 10 ml/min or ± 10 %, whichever is greater
Emptying interval (half full, worst case):	High volume AG watertrap: 17h @ 200 mL/min, 37°C, 100% RH Low volume AG watertrap: 20h @ 120 mL/min, 37°C, 100% RH
Gas:	CO ₂ , O ₂ (Paramagnetic O ₂ module), N ₂ O, and any of the five anesthetic agents: DES, ISO, ENF, SEV and HAL.
Range:	CO ₂ : 0 to 30 % O ₂ : 0 to 100 % N ₂ O : 0 to 100 % DES : 0 to 30 % SEV : 0 to 30 % ENF : 0 to 30 % ISO : 0 to 30 % HAL : 0 to 30 %
ISO accuracy mode	As Full accuracy specifications, but derated as follows: Add ± 0.3 % _{ABS} to accuracy for CO ₂ ; Add ± 8 % _{REL} to accuracy for all agents; N ₂ O accuracy is ± (8 % _{REL} + 2 % _{ABS}).

1): 10 % to 90 %. Sample gas flow: 200 ml/min. DRYLINE™ watertrap. Adult DRYLINE™ sampling line (2.5 m).

2): 10 % to 90 %. Sample gas flow: 120 ml/min. DRYLINE™ watertrap. Pediatric DRYLINE™ sampling line (2.5 m).

TABLE 9-21 AG Module

Full accuracy mode	Gas	Range (%REL)	Accuracy (%ABS)
	CO ₂	0 to 1	± 0.1
		1 to 5	± 0.2
		5 to 7	± 0.3
		7 to 10	± 0.5
		> 10	Unspecified
	N ₂ O	0 to 20	± 2
		20 to 100	± 3
	O ₂	0 to 25	± 1
		25 to 80	± 2
		80 to 100	± 3
	DES	0 to 1	± 0.15
		1 to 5	± 0.2
		5 to 10	± 0.4
		10 to 15	± 0.6
		15 to 18	± 1
	SEV	0 to 1	± 0.15
		1 to 5	± 0.2
		5 to 8	± 0.4
		> 8	Unspecified
	ENF, ISO, HAL	0 to 1	± 0.15
1 to 5		± 0.2	
> 5		Unspecified	
Rise time @ 200 ml/min ¹⁾	CO ₂ : ≤ 250 ms		
	O ₂ : ≤ 500 ms		
	N ₂ O : ≤ 250 ms		
	ENF : ≤ 350 ms		
	DES, SEV, ISO, HAL: ≤ 300 ms		
Rise time @ 120 ml/min ²⁾	CO ₂ : ≤ 250 ms		
	O ₂ : ≤ 500 ms		
	N ₂ O : ≤ 250 ms		
	ENF : ≤ 350 ms		
	DES, SEV, ISO, HAL: ≤ 300 ms		
Delay time	< 4 s		
Update time	Once per second		
Calibration	Once per year		
Primary agent ID threshold	0.15 % (0.4 % during ISO accuracy mode)		
Secondary agent ID threshold	0.3 % (0.5 % during ISO accuracy mode) or 5 % _{REL} (10 % _{REL} for Isoflurane) of primary agent if primary agent > 10 %		
Agent ID time	Less than 3 breaths, typically 12 seconds		

1): 10 % to 90 %. Sample gas flow: 200 ml/min. DRYLINE™ watertrap. Adult DRYLINE™ sampling line (2.5 m).

2): 10 % to 90 %. Sample gas flow: 120 ml/min. DRYLINE™ watertrap. Pediatric DRYLINE™ sampling line (2.5 m).

TABLE 9-21 AG Module

Measurement accuracy drift	Meets accuracy requirements within 6 hours
Rate measurement	Measurement range: 2 rpm to 100 rpm Resolution: 1 rpm Measurement accuracy: 2 rpm to 60 rpm: ± 1 rpm 60 rpm to 100 rpm: ± 2 rpm

1): 10 % to 90 %. Sample gas flow: 200 ml/min. DRYLINE™ watertrap. Adult DRYLINE™ sampling line (2.5 m).
2): 10 % to 90 %. Sample gas flow: 120 ml/min. DRYLINE™ watertrap. Pediatric DRYLINE™ sampling line (2.5 m).

TABLE 9-21 AG Module

9.10.2 Alarms

AG Alarm Limits	Range	Default	Step	Unit
EtCO ₂ High Limit	Off, 2 to 99	Adult/Ped: 50 mmHg Infant: 45 mmHg	1	mmHg, %, kPa
EtCO ₂ Low Limit	Off, 0 to 97	Adult/Ped: 25 mmHg Infant: 30 mmHg		
FiCO ₂ High Limit	Off, 1 to 99	4 mmHg		
EtO ₂ High Limit	Off, low+2 to 100	88%		
EtO ₂ Low Limit	Off, 18 to high-2	18%		
EtN ₂ O High Limit	Off, 2 to 100	55%	1	%
EtN ₂ O Low Limit	Off, 0 to 98	0%		
FiN ₂ O High Limit	Off, 2 to 100	53%		
FiN ₂ O Low Limit	Off, 0 to 98	0%		
EtHal High Limit	Off, 0.2 to 5.0	3%	0.1	%
EtHal Low Limit	Off, 0.0 to 4.8	0%		
FiHal High Limit	Off, 0.2 to 5.0	2%		
FiHal Low Limit	Off, 0.0 to 4.8	0%		
EtEnf High Limit	Off, 0.2 to 5.0	3%	0.1	%
EtEnf Low Limit	Off, 0.0 to 4.8	0%		
FiEnf High Limit	Off, 0.2 to 5.0	2%		
FiEnf Low Limit	Off, 0.0 to 4.8	0%		
EtIso High Limit	Off, 0.2 to 5.0	3%	0.1	%
EtIso Low Limit	Off, 0.0 to 4.8	0%		
FiIso High Limit	Off, 0.2 to 5.0	2%		
FiIso Low Limit	Off, 0.0 to 4.8	0%		
EtSev High Limit	Off, 0.2 to 8.0	6%	0.1	%
EtSev Low Limit	Off, 0.0 to 7.8	0%		
FiSevHigh Limit	Off, 0.2 to 8.0	5%		
FiSev Low Limit	Off, 0.0 to 7.8	0%		
EtDes High Limit	Off, 0.2 to 18.0	8%	0.1	%
EtDes Low Limit	Off, 0.0 to 17.8	0%		
FiDes High Limit	Off, 0.2 to 18.0	6%		
FiDes Low Limit	Off, 0.0 to 17.8	0%		

TABLE 9-22 Alarms

Mixed Agent	Low priority
Multiple halogenated Anesthesia agents value > 3 MAC	Medium priority

TABLE 9-22 Alarms

9.10.3 Effect of Interfering Gas on AG Measured Value

Gas Contaminants	Quantitative effect(% _{ABS}) ³⁾			
	CO ₂	N ₂ O	Agents ¹⁾	O ₂
CO ₂	0	0.1	0.1	0.2
N ₂ O	0.1	0	0.1	0.2
Agents ^{1) 2)}	0	0.1	0.1 ⁴⁾	1.0
<100 % Xenon	0.1	0	0	0.5
<50 % Helium	0.1	0	0	0.5
<0.1 % Ethanol	0	0	0	0.5
<1 % Acetone	0.1	0.1	0	0.5
<1 % Methane	0.1	0.1	0	0.5
Saturated Isopropanol vapor	0.1	0	0	0.5
Metered dose inhaler propellants	Unspecified	Unspecified	Unspecified	0.5

1) Agents represents one of DES, ISO, ENF, SEV, and HAL.

2) Multiple agent interference on CO₂, N₂O and O₂ is typically the same as single agent interference.

3) For CO₂, N₂O and Agents, maximum interference from each gas at concentrations within specified accuracy ranges for each gas. The total interference of all gases is never larger than 5 %_{REL}.

4) Interference for one of the five agents with secondary agent.

TABLE 9-23 Effect of Interfering Gas on AG Measured Value

9.11 Ventilator Specifications

General Ventilator Specifications	
Ventilation Modes:	<ul style="list-style-type: none"> • Manual ventilation mode with breathing bag • Spontaneous ventilation in manual mode with APL fully open • Volume Control Ventilation (VCV) mode with PLV function • A3: Pressure Control Ventilation (PCV) mode • A5: Pressure Control Ventilation (PCV) mode with/without VG ventilation mode • Pressure Support (PS) ventilation mode • Synchronous Intermittent Mandatory Ventilation (SIMV) mode with VCV ventilation mode • A5: Synchronous Intermittent Mandatory Ventilation (SIMV) mode with PCV ventilation mode
Patient Size:	Adult, Pediatric, Infant
Fresh Gas Flow Compensation:	Volume-compensated ventilation
Inspiratory Flow (Min/Max):	The A5/A3 does not allow combinations of ventilation parameters (e.g., I: E, Vt and Freq.) to be set if the resultant inspiratory flow is greater than 110 L/m maximum or less than 2.4 L/min minimum.
Inspiratory Flow Range:	2.4 to 110 L/min
Low Flow Anesthesia:	Tidal volume delivery at 1 L/min total fresh gas flow.
Trigger Window:	PS and SIMV are adjustable flow triggers.
Inspiratory Trigger Level:	1 to 15 L/min
Plateau (End Insp.):	Plateau pressure in VCV and SIMV-VC mode. Adjustable from Off, 5 to 60 % of inspiratory period.

TABLE 9-24 General Ventilator Specifications

Ventilator Parameter Settings Range	
Apnea Ti:	0.2 to 5.0 sec (PS), Step: 0.1 sec
Tidal Volume:	20 to 1500 ml (VCV, SIMV-VC, PCV), Step: 1 ml
Respiration Rate:	4 to 100 bpm (VCV, SIMV-VC, PCV, SIMV-PC*), Step: 1 bpm
Minimum Rate:	2 to 60 bpm (PS), Step: 1 bpm
I:E	4:1 to 1:8 (VCV, PCV), Step: 0.5
T_{insp}:	0.2 to 5 sec (SIMV-PC*, SIMV-VC), Step: 0.1 sec
P_{insp}:	5 to 70 cmH ₂ O (PCV, SIMV-PC*), Step: 1 cmH ₂ O 5 to 1500 ml volume delivery
T_{pause}:	OFF, 5 to 60 % (VCV, SIMV-VC), Step: 1 %
P_{limit}:	10 to 100 cmH ₂ O (VCV, SIMV-VC), Step: 1 cmH ₂ O
PEEP:	OFF, 3 to 30 cmH ₂ O (VCV, SIMV-VC, PCV, SIMV-PC*, PS), Step: 1 cmH ₂ O
ΔP:	3 to 50 cmH ₂ O (SIMV-VC, SIMV-PC*, PS), Step: 1 cmH ₂ O
Trigger:	1 to 15 L/min (SIMV-VC, SIMV-PC*, PS), Step: 1 L/min

TABLE 9-25 Ventilator Parameter Settings Range

Tslope:	0.0 to 2.0 sec (SIMV-VC, SIMV-PC*, PCV, PS), Step: 0.1 sec NOTE: The Tslope setting is an approximation. The exact waveform shape may not be realized under certain clinical scenarios.
VtG*	Off, 20 to 1500 ml (PCV), Step: 1
PlimVG*	5 to 100 cmH ₂ O (PCV), Step: 1 cmH ₂ O

* SIMV-PC, VtG, and PlimVG available on A5 only

TABLE 9-25 Ventilator Parameter Settings Range

Ventilator Performance	
Drive Pressure:	280 to 600 kPa
Inspiratory flow range:	2.4 to 110 L/min
Flow Valve Range:	1 to 110 L/min

TABLE 9-26 Ventilator Performance

Ventilator Monitored Parameters	
Oxygen Monitor:	Type: Galvanic fuel cell FiO ₂ displayed: 18 to 100 vol% O ₂ Accuracy of measurements: ± (volume fraction of 2.5 % + 2.5 % gas level) Response Time of O ₂ Sensor: ≤ 20 seconds Measurement accuracy drift: Meets accuracy requirements within 6 hours
Pressure Monitor:	PEEP range: 0 to 70 cmH ₂ O Pmean range: -20 to 120 cmH ₂ O Ppeak range: -20 to 120 cmH ₂ O Pplateau range: -20 to 120 cmH ₂ O
Ventilator Monitor:	Tidal Volume Range: 0 to 3000 ml Minute Volume Range: 0 to 100 L/min
Respiration Monitor:	Rate range: 0 to 120 bpm

TABLE 9-27 Ventilator Monitored Parameters

Control and Monitoring Accuracy *	
Volume Control (O₂ driving):	< 60 ml ± 10 ml ≥ 60 ml and ≤ 210 ml ± 15 ml > 210 ml ± 7 % of the set value
Pressure Control:	P _{insp} : ± 2.5 cmH ₂ O or ± 7 % of the set value, whichever is greater P _{limit} : ± 10 % of the set value
PEEP Control:	3 to 30 cmH ₂ O: ± 2.0 cmH ₂ O, or ± 10 % of the displayed value, whichever is greater OFF: not defined
Volume Monitoring (O₂ driving):	< 60 mL ± 10 ml ≥ 60 ml and ≤ 210 ml ± 18 ml > 210 ml ± 9 % of the set value
Airway Pressure Monitoring:	± 2.0 cmH ₂ O or ± 5 % of the set value, whichever is greater

TABLE 9-28 Control and Monitoring Accuracy

PEEP Monitoring Accuracy	0 to 30 cmH ₂ O: ± 2.0 cmH ₂ O, or ± 10 % of the displayed value, whichever is greater > 30 cmH ₂ O: not defined
Respiration Monitoring Accuracy:	± 1 bpm or ± 10 % of the set value, whichever is smaller
Minute Volume Monitoring Accuracy:	0 to 30 L/min ± 15 % of the displayed value, repeatable to ± 5 % over a 1-hour period

* Specifications are applicable after warm-up time of the Breathing System (Section 9.8.6).

TABLE 9-28 Control and Monitoring Accuracy

9.12 Displays and Controls Specifications

9.12.1 Electronic Controls

Display Size:	Color LCD, 15 inch diagonal, 4:3 ratio, 1024 X 768 resolution TFT technology with touch screen
Graphic Waveforms:	Airway Pressure and Flow
Graphic Virtual Flow Meters:	Displayed range (N ₂ O, Air, O ₂): 0 to 15 L/min Control range (Air, O ₂): 0 to 15 L/min Control range (N ₂ O): 0 to 10 L/min Accuracy: ± 10 % or 0.12 L/min, whichever is greater Resolution: 50 ml/min @ 0 to 1 L/min 100 ml/min @ 1 to 15 L/min
Numeric Data:	Tidal Volume, Minute Volume, Peak airway pressure, PEEP, Mean or Plateau pressure, Breath Rate, FiO ₂
AC Power Indicator LED:	Green illuminated = plugged active AC power line Not illuminated = unplugged or inactive AC power line
Battery State Indicator LED:	Solid green illuminated = battery supply is charging or fully charged Not illuminated = battery supply is discharging or not charging
Work Light:	Settings: Off, Low, High
System Switch:	ON position = power applied to unit, O ₂ fresh gas flow available Power Standby position = power applied only to charge battery supply, O ₂ fresh gas flow not available Note: Flow of Air is independent of the system switch position and is regulated by the flow control knobs.
Touchpad (A5 only):	Allows alternate control of the touch screen
Mouse:	SB port on rear of A5/A3 allows connection of a mouse for alternate control of the touch screen.

TABLE 9-29 Electronic Controls

9.12.2 Pneumatic Controls

Line Pressure Gauges:	Gauges: N ₂ O, Air, O ₂ Range: 0 to 145 psi (0 to 1000 kPa) Accuracy: ± (4 % of full scale reading + 8 % of actual reading) Units of measure: kPa, psi
Cylinder Pressure Gauges:	Gauges: N ₂ O, Air, O ₂ N ₂ O: 0 to 1400 psi (0 to 10 MPa) Air: 0 to 3500 psi (0 to 25 MPa) O ₂ : 0 to 3500 psi (0 to 25 MPa) Accuracy: ± (4 % of full scale reading + 8 % of actual reading) Units of measure: kPa, psi
Individual Flow Meter, Control Needle Valve and Knob:	Configuration: N ₂ O, Air, O ₂ Displayed Range: N ₂ O, Air, O ₂ : 0 to 15 L/min Control Range (N ₂ O): 0 to 10 L/min Control Range (Air): 0 to 15 L/min Control Range (O ₂): 0 to 15 L/min Accuracy: ± 10 % or 0.12 L/min, whichever is greater Resolution: 50 ml/min @ 0 to 1 L/min 100 ml/min @ 1 to 15 L/min Rotations: 5 (from 0 flow to maximum flow)
Total Flow Meter Range:	0 to 10 L/min ± 10 % of the indicated value for flows (between 10 % and 100 % of full scale with oxygen)
Auxiliary O₂ and Air Flow Meter:	Flow range for each meter: 0 to 15 L/min
Auxiliary O₂ Gas Power Outlet (A5 Only):	Pressure range: 280 to 600 kPa Maximum flow: ≥ 90 L/min
O₂ Flush Pushbutton (green):	Flow rate: 35 to 50 L/min
Inspiratory Airway Pressure Gauge:	Range: -20 to 100 cmH ₂ O Accuracy: ± (2 % of full scale reading + 4 % of actual reading)

TABLE 9-30 Pneumatic Controls

9.13 Alarms

Self-test:	Self-testing of alarm system functions (alarm light, speaker, and buzzer) is performed when A5/A3 System is powered on.
Alarm Indicators:	Audible: speaker / buzzer Visual: alarm light and on-screen alarm messages (Audible and visual alarms comply with the requirements of IEC 60601-1-8.)
Alarm Categories:	Physiological alarms: three levels (high, medium, low) Technical alarms: three levels (high, medium, low)
Sound Levels:	10 alarm sound levels, adjustable (levels 1 to 10)
Alarm Status:	Normal Status: all alarms are functioning properly Silence Status: silenced alarms do not produce alarm audio; only new alarms produce alarm audio
Sound Pressure levels (normal operation without alarm):	≤ 60 dBA Measured from the patient's head location at 1 meter height, 1 meter from the front of the unit, and 1 meter to the left of the unit.

TABLE 9-31 Alarms

9.14 Safety Specifications

Vibration Test:	Frequency range: 10 to 2000 Hz ASD 10 to 100 Hz: 1.0 (m/s ²) ² /Hz ASD 100 to 200 Hz: -3 dB/Octave ASD 200 to 2000 Hz: 0.5 (m/s ²) ² /Hz Duration: 10 min per perpendicular axis (3 total)
Shock Test:	Peak acceleration: 150 m/s ² (15 g) Duration: 11 ms Pulse shape: half-sine Number of shocks: 3 shocks per direction per axis (18 total)
Drop:	Complies with the requirements of clause 15.3.5 in IEC 60601-1.
Spillage and Harmful Ingress of Water:	Complies with the requirements of clause 11.6.3 in IEC 60601-1 and also the requirements in IEC 60529 for protection against vertically falling water drops equipment (IPX1).
Surface Temperature:	Complies with the requirements of clauses 11.1 in IEC 60601-1.
Mechanical Stability:	Complies with the requirements of clause 9.4 in IEC 60601-1.
Incompatibility with External Connectors:	Complies with the requirements of clause 15.4 in IEC 60601-1.
Enclosure Rigidity and Strength:	Complies with the requirements of clauses 15.3.2, 15.3.3, 15.3.6, and 15.3.7 in IEC 60601-1.
Impairment of Cooling:	Complies with the requirements of clause 13.2.7 in IEC 60601-1.
Leakage Current:	Complies with the requirements of clause 8.7 in IEC 60601-1. Earth leakage current: • Normal condition ≤ 500 μA • Single fault condition ≤ 1000 μA Enclosure leakage current: • Normal condition ≤ 100 μA • Single fault condition ≤ 300 μA Patient leakage current: • Normal condition ≤ 100 μA • Single fault condition ≤ 500 μA Patient auxiliary current DC: • Normal condition ≤ 10 μA • Single fault condition ≤ 50 μA Patient auxiliary current AC: • Normal condition ≤ 100 μA • Single fault condition ≤ 500 μA Patient leakage current (applied part plus mains voltage): • Single fault condition ≤ 5000 μA
Dielectric Strength:	Complies with the requirements of clause 8.8.3 in IEC 60601-1. Mains supply to earth (A-a1): 1500 VRMS, 1 min Mains supply to applied part (B-a): 4000 VRMS, 1 min Applied part to earth (B-d): 1500 VRMS, 1 min Isolation at network port: 1500 VRMS, 1 min

TABLE 9-32 Safety Specifications

Grounding Impedance:	Complies with the requirements of clause 8.6 in IEC 60601-1. The impedance between the protective earth terminal and any accessible metal part (e.g., screw and equipotential stud) that is protectively earthed does not exceed 0.1 ohm.
Protective Grounding:	Complies with the requirements of clause 8.6 in IEC 60601-1. The protective earth terminal is not used for the mechanical connection between different parts of the equipment or the fixing of any component not related to protective earthing or functional earthing.

TABLE 9-32 Safety Specifications

9.15 ASTM F 1208 – 89 (2005) Disclosures

Based on the following disclosures, the A5/A3 meets ASTM Standard Specification F1208 for Anesthesia Breathing Systems.

9.15.1 Leakage of Breathing System

Mode	Resistance	Pressure
Leakage (Manual mode, Bypass Off)	10.19 ml/min	@ 3 kPa
Leakage (Manual mode, Bypass On)	15.10 ml/min	@ 3 kPa
Leakage (Mechanical Ventilation mode, Bypass Off)	8.15 ml/min	@ 3 kPa
Leakage (Mechanical Ventilation mode, Bypass On)	14.77 ml/min	@ 3 kPa

TABLE 9-33 Leakage of Breathing System

9.15.2 Resistance of Breathing Systems

The typical pressure drops due to inspiratory and expiratory gas flow in the breathing system at reference flows of 0.5 and 1.0 L/s are:

- Manual, Inspiratory flow: flow rate = 0.5 L/s @ 0.59 kPa resistance
- Manual, Inspiratory flow: flow rate = 1.0 L/s @ 0.24 kPa resistance
- Manual, Expiratory flow: flow rate = 0.5 L/s @ 0.21 kPa resistance
- Manual, Expiratory flow: flow rate = 1.0 L/s @ 0.43 kPa resistance
- Auto, Inspiratory flow: flow rate = 0.5 L/s @ 0.23 kPa resistance
- Auto, Inspiratory flow: flow rate = 1.0 L/s @ 0.58 kPa resistance
- Auto, Expiratory flow: flow rate = 0.5 L/s @ 0.44 kPa resistance
- Auto, Expiratory flow: flow rate = 1.0 L/s @ 0.20 kPa resistance

9.15.3 CO₂ Absorber Resistance

For a filled CO₂ absorber, resistance at 1 L/s flow = 0.14 kPa

9.15.4 CO₂ Absorber Capacity

CO₂ absorber capacity is 1 Pre-Pak or 1500 ml.

9.15.5 Unidirectional Valve Opening Pressure

Dry: 0.03 kPa opening pressure

Wet: 0.05 kPa opening pressure.

9.16 Data Storage (Non-Volatile) and Recording

Configuration Storage:	A5/A3 supports one factory configuration group and one user configuration group. Each configuration has three patient size types: Adult, Pediatric, and Infant.
Log Storage:	500 entries of event log 500 entries of activity log 500 entries of error log 500 entries of service log

TABLE 9-34 Data Storage (Non-Volatile) and Recording

9.17 Electromagnetic Compatibility

The A5/A3 meets the requirements of IEC 60601-1-2 / EN 60601-1-2.

- NOTE:** Using accessories, sensors and cables other than those specified may result in increased electromagnetic emission or decreased electromagnetic immunity of the equipment.
- NOTE:** The anesthesia machine or its components should not be used adjacent to or stacked with other equipment. If adjacent or stacked use is necessary, the anesthesia machine or its components should be observed to verify normal operation in the configuration in which it will be used.
- NOTE:** The anesthesia machine needs special precautions regarding EMC and needs to be installed and put into service according to the EMC information provided below.
- NOTE:** Other devices may interfere with this equipment even though they meet the requirements of CISPR.
- NOTE:** When the input signal is below the minimum amplitude provided in technical specifications, erroneous measurements could result.
- NOTE:** Use of portable or mobile communications devices will degrade the performance of the equipment.

GUIDANCE AND DECLARATION - ELECTROMAGNETIC EMISSION

The A5/A3 is intended for use in the specified electromagnetic environment. The customer or the user of the A5/A3 should assure that it is used in such an environment as described below.

EMISSIONS TEST	COMPLIANCE	ELECTROMAGNETIC ENVIRONMENT - GUIDANCE
Radio frequency (RF) emissions CISPR 11	Group 1	The A5/A3 uses RF energy only for its internal function. Therefore, its RF emissions are very low and are not likely to cause any interference in nearby electronic equipment.
Radio frequency (RF) emissions CISPR 11	Class B	A5/A3 is suitable for use in all establishments, including domestic establishments and those directly connected to the public low-voltage power supply network that supplies buildings used for domestic purposes.
Harmonic emissions IEC 61000-3-2	Class A	
Voltage fluctuations/ Flicker emissions IEC 61000-3-3	Complies	

TABLE 9-35 Guidance and Declaration - Electromagnetic Emission

GUIDANCE AND DECLARATION - ELECTROMAGNETIC IMMUNITY

The A5/A3 is intended for use in the specified electromagnetic environment. The customer or the user of the A5/A3 should assure that it is used in such an environment as described below.

IMMUNITY TEST	IEC 60601 TEST LEVEL	COMPLIANCE LEVEL	ELECTROMAGNETIC ENVIRONMENT - GUIDANCE
Electrostatic discharge (ESD) IEC 61000-4-2	±6 kV contact	±6 kV contact	Floors should be wood, concrete or ceramic tile. If floors are covered with synthetic material, the relative humidity should be at least 30%.
	±8 kV air	±8 kV air	
Electrical fast transient/burst (EFT) IEC 61000-4-4	±2 kV for power supply lines	±2 kV for power supply lines	Mains power quality should be that of a typical commercial or hospital environment.
	±1 kV for input/output lines (length≥3 m)	±1 kV for input/output lines (length≥3 m)	
Surge IEC 61000-4-5	±1 kV line (s) to line (s)	±1 kV line (s) to line (s)	Mains power quality should be that of a typical commercial or hospital environment.
	±2 kV line (s) to earth	±2 kV line (s) to earth	
Voltage dips, short interruptions and voltage variations on power supply input lines IEC 61000-4-11	<5% U_T (>95% dip in U_T) for 0.5 cycle	<5% U_T (>95% dip in U_T) for 0.5 cycle	Mains power quality should be that of a typical commercial or hospital environment. If the user of A5/A3 requires continued operation during power mains interruptions, it is recommended that the A5/A3 be powered from an uninterruptible power supply (UPS) or a battery.
	40% U_T (60% dip in U_T) for 5 cycles	40% U_T (60% dip in U_T) for 5 cycles	
	70% U_T (30% dip in U_T) for 25 cycles	70% U_T (30% dip in U_T) for 25 cycles	
	<5% U_T (>95% dip in U_T) for 5 sec	<5% U_T (>95% dip in U_T) for 5 sec	
Power frequency (50/60 Hz) magnetic field IEC 61000-4-8	3 A/m	3 A/m	Power frequency magnetic fields should be at levels characteristic of a typical location in a typical commercial or hospital environment.

U_T is the A.C. mains voltage prior to application of the test level.

TABLE 9-36 Guidance and Declaration - Electromagnetic Immunity

GUIDANCE AND DECLARATION - ELECTROMAGNETIC IMMUNITY

The A5/A3 is suitable for use in the specified electromagnetic environment. The customer or the user of the A5/A3 should assure that it is used in such an environment as described below.

IMMUNITY TEST	IEC 60601 TEST LEVEL	COMPLIANCE LEVEL	ELECTROMAGNETIC ENVIRONMENT - GUIDANCE
Conducted RF IEC 61000-4-6	3 Vrms 150 kHz to 80 MHz outside ISM bands ^a	3 Vrms	Portable and mobile RF communications equipment should be used no closer to any part of the system, including cables, than the recommended separation distance calculated from the equation appropriate to the frequency of the transmitter. Recommended separation distance $d = 1.2 \times \sqrt{P}$
	10 Vrms 150 kHz to 80 MHz in ISM bands ^a	10 Vrms	
Radiated RF IEC 61000-4-3	10 V/m 80 MHz to 2.5 GHz	10 V/m	Recommended separation distance $d = 1.2 \times \sqrt{P}$ 80 MHz to 800 MHz $d = 2.3 \times \sqrt{P}$ 800 MHz to 2.5 GHz where P is the maximum output power rating of the transmitter in watts (W) according to the transmitter manufacturer and d is the recommended separation distance in meters (m) ^b . Field strengths from fixed RF transmitters, as determined by an electromagnetic site survey ^c , should be less than the compliance level in each frequency range ^d . Interference may occur in the vicinity of equipment marked with the following symbol: 

NOTE: At 80 MHz to 800 MHz, the separation distance for the higher frequency range applies.

NOTE: These guidelines may not apply in all situations. Electromagnetic propagation is affected by absorption and reflection from structures, objects and people..

- a The ISM (Industrial, Scientific and Medical) bands between 150 kHz and 80 MHz are 6,765 MHz to 6,795 MHz; 13,553 MHz to 13,567 MHz; 26,957 MHz to 27,283 MHz; and 40,66 MHz to 40,70 MHz.*
- b An additional factor of 10/3 is used in calculating the recommended separation distance for transmitters in the ISM frequency bands between 150 kHz and 80 MHz and in the frequency range 80 MHz to 2,5 GHz to decrease the likelihood that mobile/portable communications equipment could cause interference if it is inadvertently brought into patient areas.*
- c Field strengths from fixed transmitters, such as base stations for radio (cellular/cordless) telephones and land mobile radios, amateur radio, AM and FM radio broadcast and TV broadcast cannot be predicted theoretically with accuracy. To assess the electromagnetic environment due to fixed RF transmitters, an electromagnetic site survey should be considered. If the measured field strength in the location in which the A5/A3 is used exceeds the applicable RF compliance level above, the A5/A3 should be observed to verify normal operation. If abnormal performance is observed, additional measures may be necessary, such as reorienting or relocating A5/A3.*
- d Over the frequency range 150 kHz to 80 MHz, field strengths should be less than 3 V/m.*

TABLE 9-37 Guidance and Declaration - Electromagnetic Immunity

RECOMMENDED SEPARATION DISTANCES BETWEEN PORTABLE AND MOBILE RF COMMUNICATIONS EQUIPMENT AND THE A5/A3

The A5/A3 is suitable for use in an electromagnetic environment in which radiated RF disturbance are controlled. The customer or the user of the A5/A3 can help prevent electromagnetic interference by maintaining a minimum distance between portable/mobile RF communications equipment (transmitters) and the A5/A3 as recommended below, according to the maximum output power of the communications equipment.

RATED MAXIMUM OUTPUT POWER OF TRANSMITTER (W)	SEPARATION DISTANCE (M) ACCORDING TO FREQUENCY OF TRANSMITTER			
	150 kHz to 80 MHz outside ISM bands $d = 1.2 \times \sqrt{P}$	150 kHz to 80 MHz in ISM bands $d = 1.2 \times \sqrt{P}$	80 MHz to 800 MHz $d = 1.2 \times \sqrt{P}$	800 MHz to 2.5 GHz $d = 2.3 \times \sqrt{P}$
0.01	0.12	0.12	0.12	0.23
0.1	0.38	0.38	0.38	0.73
1	1.20	1.20	1.20	2.30
10	3.80	3.80	3.80	7.30
100	12.00	12.00	12.00	23.00

For transmitters rated at a maximum output power not listed above, the recommended separation distance d in meters (m) can be determined using the equation applicable to the frequency of the transmitter, where P is the maximum output power rating of the transmitter in watts (W) according to the transmitter manufacturer.

- NOTE:** At 80 MHz to 800 MHz, the separation distance for the higher frequency range applies.
- NOTE:** The ISM (Industrial, Scientific and Medical) bands between 150 kHz and 80 MHz are 6,765 MHz to 6,795 MHz; 13,553 MHz to 13,567 MHz; 26,957 MHz to 27,283 MHz; and 40,66 MHz to 40,70 MHz.
- NOTE:** An additional factor of 10/3 is used in calculating the recommended separation distance for transmitters in the ISM frequency bands between 150 kHz and 80 MHz and in the frequency range 80 MHz to 2,5 GHz to decrease the likelihood that mobile/portable communications equipment could cause interference if it is inadvertently brought into patient areas.
- NOTE:** These guidelines may not apply in all situations. Electromagnetic propagation is affected by absorption and reflection from structures, objects and people.

TABLE 9-38 Recommended separation distances between portable and mobile RF communications equipment and the A5/A3

ANESTHESIA SYSTEM'S ESSENTIAL PERFORMANCE		ESSENTIAL PERFORMANCE TESTED DURING EMC IMMUNITY TESTS	CRITERIA DURING EMC IMMUNITY
Oxygen flow under all conditions except the failure of the oxygen supply (pipeline or cylinder) to the anesthetic workstation or the generation of a technical alarm condition	Oxygen supply failure protection device	Oxygen supply failure protection device	No false O ₂ supply failure alarm shall be activated and the fresh gas flow shall be maintained when the O ₂ supply pressure is within the rated input pressure range.
	Interruption of the electrical power supply	Power management	The anesthesia system can run on AC power supply and battery supply, and <ol style="list-style-type: none"> 1. Battery in Use alarm of low priority will be indicated only in case of AC power supply failure. 2. The ventilation will be maintained, and the control and monitoring accuracy shall meet the requirements of the specification. 3. The fresh gas flow shall be maintained, and the accuracy will meet the requirements of the specification.
Delivery of a non-hypoxic gas mixture to the patient or generation of a technical alarm condition	Internal electrical power source	Battery power supply	The residual capacity of battery power can be indicated normally when battery power works.
	Protection against hazardous output	Control and monitoring accuracy	Control accuracy: Tidal volume: 50 ± 10 ml Breath rate: 40 ± 1 bpm Monitoring accuracy: Tidal volume: 50 ± 10 ml Breath rate: 40 ± 1 bpm Airway pressure: ± 2.0 cmH ₂ O or ± 5 % of the measured value, whichever is greater
	Gas mixers	Gas mixers	Accuracy: 0.2 ± 0.1 L/min
Non-delivery of excessive concentrations of a volatile anesthetic agent or generation of a technical alarm condition	Anesthetic agent monitoring equipment	Anesthetic agent monitoring equipment	Accuracy (%): CO ₂ : 5 ± 0.2 N ₂ O: 45 ± 3 DES: 5 ± 0.2 O ₂ : 45 ± 2

TABLE 9-39 Anesthesia system's EMC essential performance

Accessories

Accessory Kits.....	A-2
AG Accessories	A-2
CO2 Absorbent Canister.....	A-2
Gas Cylinder Accessories.....	A-2
Gas Supply Hoses	A-3
Manuals and Reference Cards.....	A-3
Mounting Accessories	A-3
Networking and USB Storage	A-4
Vaporizers	A-5

- WARNING:** Use only accessories specified in this chapter. Using other accessories may cause incorrect measured values or equipment damage.
- WARNING:** Disposable accessories cannot be reused. Reuse may degrade performance or cause cross-contamination.
- WARNING:** Check the accessories and their packages for damage. Do not use them if any sign of damage is detected.
- WARNING:** At the end of its service life, the equipment, as well as its accessories, must be disposed of in compliance with the guidelines regulating the disposal of such products, and in accordance with local regulations for contaminated and biologically hazardous items.

The following accessories are designed for the A5/A3 Anesthesia System. The use of other accessories is not recommended. To place an order for these or other accessories, contact Customer Service at 1 (800)288-2121 or order accessories online at www.mindray.com.

A.1 Accessory Kits

PART NUMBER	DESCRIPTION
121-000994-00	A5 Kit, User Resource Kit

A.2 AG Accessories

PART NUMBER	DESCRIPTION
9200-10-10530	Watertrap (high volume, reusable)
9200-10-10574	Watertrap (low volume, reusable)
9200-10-10533	Sampling line (high volume, disposable)
9200-10-10555	Sampling line (low volume, disposable)
9000-10-07486	Airway adapter (straight, disposable)
9000-10-07487	Airway adapter (elbow, disposable)
6800-30-50502	Gas Module without BIS
6800-30-50842	Multi-gas module with accessory kit
115-016612-00	O ₂ Port Cover Kit

A.3 CO₂ Absorbent Canister

PART NUMBER	DESCRIPTION
0683-00-0326-12	CO ₂ Absorbent, Pre-Pak (12)

A.4 Gas Cylinder Accessories

PART NUMBER	DESCRIPTION
0348-00-0185	Washer, Seal for Cylinder

A.5 Gas Supply Hoses

PART NUMBER	DESCRIPTION (15 FOOT LENGTH)
0004-00-0077-11	O ₂ Gas Supply Hose, 15 ft, Ohmeda
0004-00-0077-12	O ₂ Gas Supply Hose, 15 ft, Chemetron
0004-00-0077-13	O ₂ Gas Supply Hose, 15 ft, Puritan Bennett
0004-00-0077-14	O ₂ Gas Supply Hose, 15 ft, DISS Female
0004-00-0078-11	N ₂ O Gas Supply Hose, 15 ft, Ohmeda
0004-00-0078-12	N ₂ O Gas Supply Hose, 15 ft, Chemetron
0004-00-0078-13	N ₂ O Gas Supply Hose, 15 ft, Puritan Bennett
0004-00-0078-14	N ₂ O Gas Supply Hose, 15 ft, DISS Female
0004-00-0079-11	Air Gas Supply Hose, 15 ft, Ohmeda
0004-00-0079-12	Air Gas Supply Hose, 15 ft, Chemetron
0004-00-0079-13	Air Gas Supply Hose, 15 ft, Puritan Bennett
0004-00-0079-14	Air Gas Supply Hose, 15 ft, DISS Female
0004-00-0080-13	VAC Gas Supply Hose, 15 ft, Ohmeda
0004-00-0080-14	VAC Gas Supply Hose, 15 ft, Chemetron
0004-00-0080-15	VAC Gas Supply Hose, 15 ft, Puritan Bennett
0004-00-0080-16	VAC Gas Supply Hose, 15 ft, DISS Female
0004-00-0081-11	EVAC Gas Supply Hose, 15 ft, Ohmeda
0004-00-0081-12	EVAC Gas Supply Hose, 15 ft, Chemetron
0004-00-0081-13	EVAC Gas Supply Hose, 15 ft, Puritan Bennett
0004-00-0081-14	EVAC Gas Supply Hose, 15 ft, DISS Female
0004-00-0081-31	EVAC DISS to VAC Ohmeda Gas Supply Hose, 15 ft
0004-00-0081-32	EVAC DISS to VAC Chemetron Gas Supply Hose, 15 ft
0004-00-0081-33	EVAC DISS to VAC Puritan Bennett Gas Supply Hose, 15 ft
0004-00-0081-34	EVAC DISS to VAC DISS Female Gas Supply Hose, 15 ft

A.6 Manuals and Reference Cards

PART NUMBER	DESCRIPTION
046-003777-01	A5/A3 Operations Manual (Hardcopy, English)
046-009638-00	Disinfection / Cleaning Card
801-0631-00081-00	A5/A3 Pre-Operation Checklist (English)
801-0631-00082-00	A5/A3 Auxiliary O ₂ /Air Reference Card

A.7 Mounting Accessories

PART NUMBER	DESCRIPTION
0436-00-0169	Monitor Mounting Arm, Pivot, 12"
0386-00-0344	Mounting Kit, GM3 to GCX mount adapter plate

PART NUMBER	DESCRIPTION
0040-00-0452	Mounting Kit, Passport 12M / 17M, DPM6/7, T5 & T8 to GCX Mount Adapter Plate
115-009637-00	Kit for SMR to A5/A3 without Hooks
0436-00-0198	Monitor Mounting Arm, Pivot, 16"
0436-00-0258	Utility Tray, Two Pivot, 24"
045-000250-00	Writing Surface Insert (for Utility Tray)
0436-00-0259	Mount, Suction Canister
0992-00-0256	Regulator, Patient Suction
0436-00-0207	Mounting Arm, Suction Regulator
050-000702-00	Mounting Adapter Plate with Cable Hooks
115-011304-00	Cable Management Kit
115-004003-00	Mounting Kit for Passport 17M / DPM7 Monitor (top mounting)
115-004004-00	Mounting Kit for Passport 12M / DPM6 Monitor (top mounting)
008-000468-00	CPU Mount 3-4.5"/7.6-11.4 cm wide
008-000468-01	CPU Mount 1.5-3"/3.8-7.6 cm wide
008-000468-02	CPU Mount 4.5-7"/11.4-17.8 cm wide
008-000468-03	CPU Mount 7-9.5"/17.8-24.1 cm wide
115-021015-00	Spring hook material package
034-000288-00	AIMS Mounting Arm
121-001111-00	A Series AIMS Mounting Ergotron kit (kit contents listed below)
045-000794-00	Ergotron AIMS Adjustable Mounting Bracket
045-000795-00	Ergotron AIMS Mounting Arm
115-017467-00	Ergotron Mounting System

A.8 Networking and USB Storage

PART NUMBER	DESCRIPTION
0012-00-1274-01	CAT 5 Ethernet Cable, Patch, STP, 6' (1.83 m)
0012-00-1274-02	CAT 5 Ethernet Cable, Patch, STP, 25' (7.62 m)
0012-00-1392-05	CAT 5 Ethernet Cable, Crossover, STP, 3' (0.91 m)
0012-00-1392-06	CAT 5 Ethernet Cable, Crossover, STP, 6' (1.83 m)
0012-00-1392-07	CAT 5 Ethernet Cable, Crossover, STP, 10' (3.05 m)
0992-00-0297-01	USB Storage Device, 2 GB
0000-10-10751	USB Wired Mouse
0992-00-0297-03	USB Storage Device, 8 GB
0992-00-0297-04	USB Storage Device, 16 GB

A.9 Vaporizers

PART NUMBER	DESCRIPTION
0992-00-0148	Sevoflurane Vaporizer with Quick Fill Adapter
0004-00-0100	Sevoflurane Quick Fill Bottle Adapter
0992-00-0149	Isoflurane Vaporizer with Fill Adapter
0004-00-0101	Isoflurane Fill Bottle Adapter
115-020218-00	Three vaporizer mount
040-001997-00	Desflurane Vaporizer
115-025532-00	Mindray Sevoflurane Quik Filler Vaporizer
040-000067-00	Mindray Quik-Fil Drain Funnel Adaptor
115-026747-00	Mindray Quik-Fil filling adapter for sevoflurane
115-025535-00	Mindray Isoflurane Key Filler Vaporizer
040-002707-00	Mindray Key Filler Adaptor for Isoflurane

A.10 Scavenging Accessories

PART NUMBER	DESCRIPTION
115-037548-00	Passive scavenging kit

The Dynamic Gas Scavenging System (DGSS) from Anesthetic Gas Reclamation is approved for use on the A5/A3.

NOTE: The Active AGSS comes standard with the A5 system.

This page intentionally left blank.

User Accessible Spare Parts

Active AGSS	B-2
Breathing System.....	B-2
CO2 Absorbent Canister.....	B-2
Flow Sensor	B-2
Gas Cylinder Accessories.....	B-3
O2 Sensor.....	B-3
Battery.....	B-3

The following spare parts are designed for the A5/A3 Anesthesia System. The use of other spare parts is not recommended. To place an order for these or other spare parts, contact Customer Service at 1 (800)288-2121 or order spare parts online at www.mindray.com.

B.1 Active AGSS

PART NUMBER	DESCRIPTION
115-023175-00	Waste Gas Scavenger Assembly
801-0631-00074-00	AGSS Transfer Tube
801-0631-00078-00	Waste Gas Hose for Gas module to Quick Release Fitting

B.2 Breathing System

PART NUMBER	DESCRIPTION
801-0631-00054-00	Bellows Dome, A Series
0601-30-78968	Bellows Assembly, A Series
801-0631-00057-00	Insp/Exp Connector, A Series
801-0631-00059-00	Insp/Exp Connector Rotary Cap, A Series
801-0631-00058-00	Water Trap, A Series
801-0631-00061-00	Check valve dome, A Series
801-0631-00104-00	Check valve, A Series
115-017033-00	Bag Arm - Fixed Height, A Series
115-028041-00	Flexible Bag Arm , A Series
115-025563-00	Airway pressure gauge, A Series
801-0631-00062-00	APL valve, A Series
115-017036-00	Breathing system, A3/A5

B.3 CO₂ Absorbent Canister

PART NUMBER	DESCRIPTION
801-0631-00066-00	CO ₂ Absorbent Canister, A Series
801-0631-00099-00	CO ₂ Bypass Assembly, A Series
801-0631-00092-00	CO ₂ Absorber Hose, A Series
801-0631-00100-00	CO ₂ Absorber Base with Drain Valve, A Series

B.4 Flow Sensor

PART NUMBER	DESCRIPTION
801-0631-00056-00	Expiratory Flow Sensor Assembly, A Series
801-0631-00060-00	Inspiratory Flow Sensor Assembly, A Series
115-008264-00	Flow sensor kit

B.5 Gas Cylinder Accessories

PART NUMBER	DESCRIPTION
115-033063-00	Gas Cylinder Wrench

B.6 O₂ Sensor

PART NUMBER	DESCRIPTION
040-001270-00	O ₂ Sensor, A Series
801-0631-00102-00	O ₂ Sensor Cable and Housing, A Series
801-0631-00091-00	O ₂ Sensor Cable, A Series

B.7 Battery

PART NUMBER	DESCRIPTION
115-018012-00	Lithium-ion Battery

This page intentionally left blank.

Parameters and Factory Defaults

Waveform/Spirometry Tabs (A5 Only)	C-2
Alarm Limits	C-3
Setup Menu.....	C-5
Alarm Volume and History.....	C-8
Date and Time	C-8
Demographics.....	C-9
Ventilation Modes	C-9
Linked Ventilation Parameter	C-13
Ventilation Parameter Relationships.....	C-15

C.1 Waveform/Spirometry Tabs (A5 Only)

OBJECT	RANGE	DEFAULT	Current selection saved when powered off
Waveform/Spirometry Tab	Waveform tab, Spirometry tab	Waveform tab	No
Spirometry Tab: Loop Type	Pressure - Volume, Flow - Volume, Pressure- Flow	Pressure - Volume	No
Spirometry Tab: Save Loop	Reference, Baseline	Reference	No
Spirometry Tab: Show Reference	Off, Baseline, [time]	Off	No
Spirometry Tab: Review Loops: Loop Type	Pressure - Volume, Flow - Volume, Pressure- Flow	Pressure - Volume	No

C.2 Alarm Limits

PARAMETER	RANGE	DEFAULT	UNIT	Current selection saved when powered off
PEAK High	The greater of 10 and (PEAK Low+1) to 100 Step: 1	Adult: 50 Pediatric: 40 Infant: 40	cmH ₂ O	Yes
PEAK Low	0 to the lesser of 70 and (PEAK High-1) Step: 1	Adult: 10 Pediatric: 8 Infant: 8	cmH ₂ O	Yes
MV High	The greater of 0.2 and (MV Low+0.1) to 25 Step: 0.1	Adult: 12 Pediatric: 6 Infant: 6	L/min	Yes
MV Low	0 to the lesser of 20 and (MV High-1) Step: 0.1	Adult: 1 Pediatric: 1 Infant: 0.2	L/min	Yes
FiO₂ High	The greater of 21 and (FiO ₂ Low+1) to 100, Off Step: 1	Off	%	Yes
FiO₂ Low	18 to the lesser of 98 and (FiO ₂ High-1) Step: 1	18	%	Yes
EtCO₂ High	Off, 2 to 99 Step: 1	Adult: 50 mmHg Pediatric: 50 mmHg Infant: 45 mmHg	mmHg, % kPa	Yes
EtCO₂ Low	Off, 0 to 97 Step: 1	Adult: 25 mmHg Pediatric: 25 mmHg Infant: 30 mmHg	mmHg, % kPa	Yes
FiCO₂ High	Off, 1 to 99 Step: 1	4	%	Yes
EtN₂O High	Off, (Low+2) to 100 Step: 1	55	%	Yes
EtN₂O Low	Off, 0 to (High-2) Step: 1	0	%	Yes
FiN₂O High	Off, (Low+2) to 100 Step: 1	53	%	Yes
FiN₂O Low	Off, 0 to (High-2) Step: 1	0	%	Yes
EtHal High	Off, (Low+0.2) to 5.0 Step: 0.1	3	%	Yes
EtHal Low	Off, 0.0 to (High-0.2) Step: 0.1	0	%	Yes
FiHal High	Off, (Low+0.2) to 5.0 Step: 0.1	2	%	Yes
FiHal Low	Off, 0.0 to (High-0.2) Step: 0.1	0	%	Yes
EtEnf High	Off, (Low+0.2) to 5.0 Step: 0.1	3	%	Yes

PARAMETER	RANGE	DEFAULT	UNIT	Current selection saved when powered off
EtEnf Low	Off, 0.0 to (High-0.2) Step: 0.1	0	%	Yes
FiEnf High	Off, (Low+0.2) to 5.0 Step: 0.1	2	%	Yes
FiEnf Low	Off, 0.0 to (High-0.2) Step: 0.1	0	%	Yes
EtIso High	Off, (Low+0.2) to 5.0 Step: 0.1	3	%	Yes
EtIso Low	Off, 0.0 to (High-0.2) Step: 0.1	0		Yes
Filso High	Off, (Low+0.2) to 5.0 Step: 0.1	2	%	Yes
Filso Low	Off, 0.0 to (High-0.2) Step: 0.1	0	%	Yes
EtSev High	Off, (Low+0.2) to 8.0 Step: 0.1	6	%	Yes
EtSev Low	Off, 0.0 to (High-0.2) Step: 0.1	0		Yes
FiSev High	Off, (Low+0.2) to 8.0 Step: 0	5	%	Yes
FiSev Low	Off, 0.0 to (High-0.2) Step: 0.1	0	%	Yes
EtDes High	Off, (Low+0.2) to 18.0 Step: 0.1	8	%	Yes
EtDes Low	Off, 0.0 to (High-0.2) Step: 0.1	0	%	Yes
FiDes High	Off, (Low+0.2) to 18.0 Step: 0.1	6	%	Yes
FiDes Low	Off, 0.0 to (High-0.2) Step: 0	0	%	Yes
EtO2 High	Off, (Low+0.2) to 100 Step: 1	88	%	Yes
EtO2 Low	Off, 10 to (High-2) Step: 1	Off	%	Yes
CO2 Apnea Delay Time	10 sec, 15 sec, 20 sec, 25 sec, 30 sec, 35 sec, 40 sec	30	sec,	Yes

C.3 Setup Menu

PARAMETER	RANGE	DEFAULT	Current selection saved when powered off
General Tab: Breathing System	Warmer On, Warmer Off	Warmer On	No
General Tab: Gas Bench Flow Rate	Adult watertrap: Low (120 ml/min), Med (150ml/min), High (200 ml/min) Infant watertrap: Low (70 ml/min), Med (90 ml/min), High (120 ml/min)	Low (120 ml/min)	Yes
Display Tab: Pressure Display	Mean, PLAT	PLAT	Yes
Display Tab: Plimit Line	On/Off	On	Yes
Display Tab: Screen Brightness	level 1-10	5	Yes
Display Tab: Key Click Volume	level 1-10	3	Yes
Display Tab: CO₂ Placement	Top, Bottom	Top	Yes
Display Tab: Gas Scales: CO₂ Scale	0-40 mmHg, 0-60 mmHg, 0-80 mmHg	0-60 mmHg	Yes
Display Tab: Gas Scales: Des Scale	0-6.0%, 0-9.0%, 0-18.0%	0-9.0%	Yes
Display Tab: Gas Scales: Sev Scale	0-2.0%, 0-4.0%, 0-8.0%	0-4.0%	Yes
Display Tab: Gas Scales: Iso Scale	0-1.2%, 0-2.5%, 0-5.0%	0-2.5%	Yes
Display Tab: Gas Scales: Hal Scale	0-1.2%, 0-2.5%, 0-5.0%	0-2.5%	Yes
Display Tab: Gas Scales: Enf Scale	0-1.2%, 0-2.5%, 0-5.0%	0-2.5%	Yes
Display Tab: Gas Scales: O₂ Scale	0-35%, 0-50%, 0-100%	0-100%	Yes
Display Tab: Gas Scales: N₂O Scale	0-35%, 0-50%, 0-100%	0-100%	Yes

PARAMETER	RANGE	DEFAULT	Current selection saved when powered off
Display Tab: Waveform Display	No module: Volume, Flow AG module: Volume, Flow, AA, O ₂ , N ₂ O	Flow	Yes
System Tab: Language	CHINESE, ENGLISH, FRENCH, SPANISH, PORTUGUESE, RUSSIAN, TURKISH, DUTCH	ENGLISH	Yes
System Tab: Default Settings: Default Patient Size	Adult, Pediatric, Infant	Infant	Yes
System Tab: Default Settings: Default Vent Mode	VCV, SIMV-VC, PCV, SIMV-PC, PS	VCV	Yes
System Tab: Manage Defaults	Save as O.R. Defaults, Load O.R. Defaults, Restore Partial Defaults, Import Defaults, Export Defaults	Save as O.R. Defaults	No
System Tab: Change Password	—	1234	Yes
System Tab: Units: Pressure	cmH ₂ O, hPa, mbar	cmH ₂ O	Yes
System Tab: Units: CO₂	mmHg, kPa, %	mmHg	Yes
System Tab: Clear Historys	On, Off	Off	Yes
System Tab: Time Settings: Daylight Savings	Manual, Auto	Manual	Yes
System Tab: Network: This Machine: Configure Ethernet: IP Address	0 - 255	192.168.23.250	Yes
System Tab: Network: This Machine: Configure Ethernet: Subnet	0 - 255	255.255.255.0	Yes
System Tab: Network: This Machine: Configure Ethernet: Default Gateway	0 - 255	—	Yes
System Tab: Network: This Machine: Configure Serial: Baud Rate	4800, 9600, 57600, 115200	9600	Yes
System Tab: Network: This Machine: Configure Serial: Parity	Odd, Even, None	None	Yes
System Tab: Network: This Machine: Configure Serial: Data Bits	8, 7, 6, 5	8	Yes

PARAMETER	RANGE	DEFAULT	Current selection saved when powered off
System Tab: Network: This Machine: Configure Serial: Protocol	None, HL7, MR-WATO, Philips	None	Yes
System Tab: Network: This Machine: Configure Serial: Interval	10 sec, 30 sec, 1 min, 5 min, 30 min, 1 hour, 2 hour, 6 hour, 12 hour, 24 hour	1 min	Yes
System Tab: Network: This Machine: Configure Serial: Stop Bits	2, 1.	1	Yes
System Tab: Network: Network Protocol: Configure HL7: Interval	10 sec, 30 sec, 1 min, 5 min, 30 min, 1 hr, 2 hr, 6 hr, 12 hr, 24 hr	1 min	Yes
System Tab: Network: Network Protocol: Configure HL7: Destination IP	—	192.168.23.200	Yes
System Tab: Network: Network Protocol: Configure HL7: Port	0 - 65535	1550	Yes
System Tab: Network: Network Protocol: Configure HL7: Set HL7 Compatibility	Most Recent, 02.02.01 to 02.10.00, 02.00.00, 01.05.02, 01.00.00 to 01.05.01, None	Most Recent	Yes
System Tab: Network: Network Protocol: Configure HL7: Send Waveforms	On, Off	Off	Yes
System Tab: Network: Network Protocol: Configure HL7: Send Alarms	On, Off	Off	Yes
System Tab: Network: Network Protocol: Configure HL7: Send Alarms Ack.	On, Off	Off	Yes
System Tab: Network: Network Protocol: MD2	On, Off	Off	Yes
System Tab: Network: Network Protocol: Configure MD2: Destination IP	—	192.168.23.99	Yes
System Tab: Network: Network Protocol: Configure MD2: Port	—	6678	Yes
System Tab: Network: SNTP Protocol: Interval	10 sec, 30 sec, 1 min, 5 min, 30 min, 1 hr, 2 hr, 6 hr, 12 hr, 24 hr	Off	Yes

PARAMETER	RANGE	DEFAULT	Current selection saved when powered off
System Tab: Network: SNTP Protocol: Primary Server IP	0 - 255	132.163.4.103	Yes
System Tab: Network: SNTP Protocol: Secondary Server IP	0 - 255	210.72.145.44	Yes

C.4 Alarm Volume and History

PARAMETER	RANGE	DEFAULT	Current selection saved when powered off
Alarm Volume	level 1-10	3	Yes
System Alerts Volume	level 1-10	3	Yes
Event Log: Filter	High, Medium, Low, All, Informational	All	Yes
Display Interval	1 min, 5 min, 10 min, 1 min, 30 min, 1 hr, 2 hrs	1 min	Yes
Display Group	Fresh Gas, Gas, Ventilation, All	All	Yes

C.5 Date and Time

PARAMETER	RANGE	DEFAULT	Current selection saved when powered off
Day	1-31	1	Yes
Month	1-12	1	Yes
Year	1900-2099	2009	Yes
Hour	—	00 (24 hr) 12 AM(12 hr)	Yes
Minute	00-60	00	Yes
AM/PM	AM/PM	AM	Yes
12/24 hour	12, 24	12	Yes
Date format	YYYY/MM/DD, MM/DD/YYYY, DD/MM/YYYY	YYYY/MM/DD	Yes
Daylight Savings Time	On, Off	Off	Yes

C.6 Demographics

PARAMETER	RANGE	DEFAULT
Patient ID	—	—
Bed	—	—
First Name	—	—
Room	—	—
Last Name	—	—
Point of Care	—	—
DOB	—	—
Age	—	—
Weight (Lbs.)	—	—
Facility	—	—

C.7 Ventilation Modes

OBJECT	RANGE	DEFAULT	Current selection saved when powered off
Ventilation Mode Tab	VCV, SIMV-VC, PCV, SIMV-PC*, PS	VCV	Yes

* SIMV-PC available only on A5.

VENTILATION MODE	PARAMETERS
Manual	Bypass**, Alarms
VCV	Vt, Rate, I:E, Tpause, PEEP, Plimit
SIMV-VC	Vt, Rate, Tinsp, Tpause, PEEP, Plimit, PS (On/Off), ΔP, Trigger, Tslope
PCV	VtG**, PlimVG**, PInsp, Rate, I:E, PEEP, Tslope
SIMV-PC**	PInsp, Rate, Tinsp, PS (On/Off), ΔP, Trigger, PEEP, Tslope
PS	Min Rate, ΔP, Trigger, PEEP, Tslope, Apnea Ti

** SIMV-PC, VtG, PlimVG, and Bypass are available only on A5.

PARAMETER	VCV	SIMV-VC	PCV	SIMV-PC	PS	MANUAL
Vt	Range: 20 to 1500 ml Step: 1 Defaults: Adult: 600 ml Pediatric: 120 ml Infant: 20 ml	Range: 20 to 1500 ml Step: 1 Defaults: Adult: 600 ml Pediatric: 120 ml Infant: 20 ml	—	—	—	—
VtG (A5 only)	—	—	Range: 20 to 1500 ml Step: 1 Default: Off	—	—	—
VG (A5 only)	—	—	Default: Off	—	—	—
Rate	Range: 4 to 100 bpm Step: 1 bpm Defaults: Adult: 8 bpm Pediatric: 15 bpm Infant: 20 bpm	Range: 4 to 100 bpm Step: 1 bpm Defaults: Adult: 8 bpm Pediatric: 15 bpm Infant: 20 bpm	Range: 4 to 100 bpm Step: 1 bpm Defaults: Adult: 8 bpm Pediatric: 15 bpm Infant: 20 bpm	Range: 4 to 100 bpm Step: 1 bpm Defaults: Adult: 8 bpm Pediatric: 15 bpm Infant: 20 bpm	—	—
Min. Rate	—	—	—	—	Range: 2 to 60 bpm Step: 1 bpm Defaults: Adult: 4 bpm Pediatric: 6 bpm Infant: 12 bpm	—
I:E	Range: 1:8 to 4:1 Step: 0.5 Default: 1:2	—	Range: 1:8 to 4:1 Step: 0.5 Default: 1:2	—	—	—

PARAMETER	VCV	SIMV-VC	PCV	SIMV-PC	PS	MANUAL
T_{insp}	—	Range: 0.2 to 5 sec Step: 0.1 sec Defaults: Adult: 2.0 sec Pediatric: 1.0 sec Infant: 1.0 sec	—	Range: 0.2 to 5 sec Step: 0.1 sec Defaults: Adult: 2.0 sec Pediatric: 1.0 sec Infant: 1.0 sec	—	—
P_{insp}	—	—	Range: PEEP+5 to 70 cmH ₂ O Step: 1 cmH ₂ O Defaults: Adult: 15 cmH ₂ O Pediatric: 10 cmH ₂ O Infant: 10 cmH ₂ O	Range: PEEP+5 to 70 cmH ₂ O Step: 1 cmH ₂ O Defaults: Adult: 15 cmH ₂ O Pediatric: 10 cmH ₂ O Infant: 10 cmH ₂ O	—	—
T_{pause}	Range: Off, 5% to 60% Step: 1% Default: 10%	Range: Off, 5% to 60% Step: 1% Default: 10%	—	—	—	—
P_{limit}	Range: 10 to 100 cmH ₂ O Step: 1 cmH ₂ O Defaults: Adult: 50 cmH ₂ O Pediatric: 40 cmH ₂ O Infant: 20 cmH ₂ O	Range: 10 to 100 cmH ₂ O Step: 1 cmH ₂ O Defaults: Adult: 50 cmH ₂ O Pediatric: 40 cmH ₂ O Infant: 20 cmH ₂ O	—	—	—	—
P_{limVG} (A5 only)	—	—	Range: 5 - 100 cmH ₂ O Step: 1 cmH ₂ O Default: P _{insp}	—	—	—
PEEP	Range: Off, 3 to 30 cmH ₂ O Step: 1 cmH ₂ O Default: Off	Range: Off, 3 to 30 cmH ₂ O Step: 1 cmH ₂ O Default: Off	Range: Off, 3 to 30 cmH ₂ O Step: 1 cmH ₂ O Default: Off	Range: Off, 3 to 30 cmH ₂ O Step: 1 cmH ₂ O Default: Off	Range: Off, 3 to 30 cmH ₂ O Step: 1 cmH ₂ O Default: Off	—

PARAMETER	VCV	SIMV-VC	PCV	SIMV-PC	PS	MANUAL
P	—	Range: 3 to 50 cmH ₂ O Step: 1 Defaults: Adult: 8 cmH ₂ O Pediatric: 5 cmH ₂ O Infant: 5 cmH ₂ O	—	Range: 3 to 50 cmH ₂ O Step: 1 Defaults: Adult: 8 cmH ₂ O Pediatric: 5 cmH ₂ O Infant: 5 cmH ₂ O	Range: 3 to 50 cmH ₂ O Step: 1 Defaults: Adult: 8 cmH ₂ O Pediatric: 5 cmH ₂ O Infant: 5 cmH ₂ O	—
Trigger	—	Range: 1 to 15 L/min Step: 1 Defaults: Adult: 3 L/min Pediatric: 2 L/min Infant: 2 L/min	—	Range: 1 to 15 L/min Step: 1 Defaults: Adult: 3 L/min Pediatric: 2 L/min Infant: 2 L/min	Range: 1 to 15 L/min Step: 1 Defaults: Adult: 3 L/min Pediatric: 2 L/min Infant: 2 L/min	—
Tslope *	—	Range: 0.0 to 2.0 sec Step: 0.1 sec Default: 0.2 sec	Range: 0.0 to 2.0 sec Step: 0.1 sec Default: 0.2 sec	Range: 0.0 to 2.0 sec Step: 0.1 sec Default: 0.2 sec	Range: 0.0 to 2.0 sec Step: 0.1 sec Default: 0.2 sec	—
PS	—	Range: On, Off Step: — Default: Off	—	Range: On, Off Step: — Default: Off	—	—
Bypass (A5 only)	—	—	—	—	—	Range: On, Off Step: — Default: Off
Alarm	—	—	—	—	—	Range: On, Off Step: — Default: On
Apnea Ti	—	—	—	—	Range: 0.2 to 5.0 sec Step: 0.1 sec Default: 5.0 sec (adult) 3.0 sec (Pediatric) 2.0 sec (Infant)	—

* The Tslope setting is an approximation. The exact waveform shape may not be realized under certain clinical scenarios.

C.8 Linked Ventilation Parameter

The table below lists how parameter values are affected when changing ventilation modes. For example, ventilation modes that share the same parameters may also share the same parameter values when changing from one ventilation mode to the other. Other parameters may have their values set differently when changing ventilation modes.

CURRENT VENTILATION MODE & PARAMETERS AFFECTED		PREVIOUS VENTILATION MODE				
		VCV	SIMV-VC	PCV	SIMV-PC	PS
VCV	Vt	—	*	Measured Vt or last value	*	*
	Rate	—	*	*	*	*
	I:E	—	*	*	*	*
	Tpause	—	*	*	*	*
	PEEP	—	*	*	*	*
	Plimit	—	*	*	*	*
SIMV-VC	Vt	*	—	Measured Vt or last value	*	*
	Rate	*	—	*	*	*
	Tinsp	*	—	*	*	*
	Tpause	*	—	*	*	*
	PEEP	*	—	*	*	*
	Plimit	*	—	*	*	*
	PS	*	—	*	*	PS = On
	ΔP	*	—	*	*	*
	Trigger	*	—	*	*	*
	Tslope	*	—	*	*	*
PCV	VtG***	*	*	—	*	*
	Pinsp	PLAT or 80% PEAK or last value	*	—	*	*
	Rate	*	*	—	*	*
	I:E	*	*	—	*	*
	PEEP	*	*	—	*	*
	PlimVG***	If VtG=OFF, then Pinsp. If VtG is a value, then last value of PlimVG.	If VtG=OFF, then Pinsp. If VtG is a value, then last value of PlimVG.	—	If VtG=OFF, then Pinsp. If VtG is a value, then last value of PlimVG.	If VtG=OFF, then Pinsp. If VtG is a value, then last value of PlimVG.
	Tslope	*	*	—	*	*

* The parameter value is shared between the previous and current ventilation modes.

*** Available on A5 only.

CURRENT VENTILATION MODE & PARAMETERS AFFECTED		PREVIOUS VENTILATION MODE				
		VCV	SIMV-VC	PCV	SIMV-PC	PS
SIMV-PC***	P _{insp}	PLAT or 80% PEAK or last value	*	*	—	*
	Rate		*	*	—	*
	T _{insp}		*	*	—	*
	PS		*	*	—	PS = On
	P		*	*	—	*
	Trigger		*	*	—	*
	PEEP		*	*	—	*
	T _{slope}		*	*	—	*
PS	Min Rate		*	*	*	—
	P		*	*	*	—
	Trigger		*	*	*	—
	Peep		*	*	*	—
	T _{slope}		*	*	*	—
	Apnea Ti		*	*	*	—

* The parameter value is shared between the previous and current ventilation modes.

*** Available on A5 only.

C.9 Ventilation Parameter Relationships

VENTILATION MODE	Parameter	Parameter Relationship Equation (s)
VCV	Rate	$Rate \leq 300 \times \frac{I : E}{1 + I : E}$
		$Rate \leq 150 \times \frac{1}{1 + I : E}$
		$4 \leq Rate \leq 100$
	Vt	$Vt \leq 1833 \times \frac{60 \times \left(\frac{I : E}{1 + I : E} \right) * (1 - TP)}{Rate}$
$Vt \geq 20 \times \frac{60 \times \left(\frac{I : E}{1 + I : E} \right) (1 - TP)}{Rate}$		
	$20 \leq Vt \leq 1500$	
	Plimit	Plimit \geq PEEP+5 $10 \leq$ Plimit \leq 100
SIMV-VC	Rate	$Rate \leq \frac{60}{T_{insp} + 0.4}$
		$4 \leq Rate \leq 100$
	Vt	$20 \times T_{insp} (1 - TP) \leq Vt \leq 1833 \times T_{insp} (1 - TP)$
		$20 \leq Vt \leq 1500$
P	P \leq Plimit-PEEP $3 \leq$ P \leq 50	
	Plimit	Plimit \geq PEEP+5 Plimit \geq P+PEEP $10 \leq$ Plimit \leq 100

VENTILATION MODE	Parameter	Parameter Relationship Equation (s)
PCV	Rate	$Rate \leq 300 \times \frac{I:E}{1+I:E}$
		$Rate \leq 150 \times \frac{1}{1+I:E}$
		$4 \leq Rate \leq 100$
	VtG	If VtG is not Off.
		$VtG \geq 20 \times \frac{60 \times \left(\frac{I:E}{1+I:E} \right)}{Rate}$
	$VtG \leq 1833 \times \frac{60 \times \left(\frac{I:E}{1+I:E} \right)}{Rate}$	
	$20 \leq Vt \leq 1500$	
	Pinsp (A5 only)	Pinsp \geq PEEP+5 $5 \leq$ Pinsp \leq 70
	PlimVG (A5 only)	PlimVG \geq PEEP+5 $5 \leq$ PlimVG \leq 100
SIMV-PC (A5 ONLY)	Rate	$Rate \leq \frac{60}{T_{insp} + 0.4}$
		$4 \leq Rate \leq 100$
	Pinsp	Pinsp \geq PEEP+5 $5 \leq$ Pinsp \leq 70

NOTE: Even when the PlimVG, Pinsp, or P parameters are inactive, they are restricted to the parameter relationship equations.

D.0

Pneumatic Diagram

Pneumatic Diagram of the A5/A3 SystemD-2

D.1 Pneumatic Diagram of the A5/A3 System

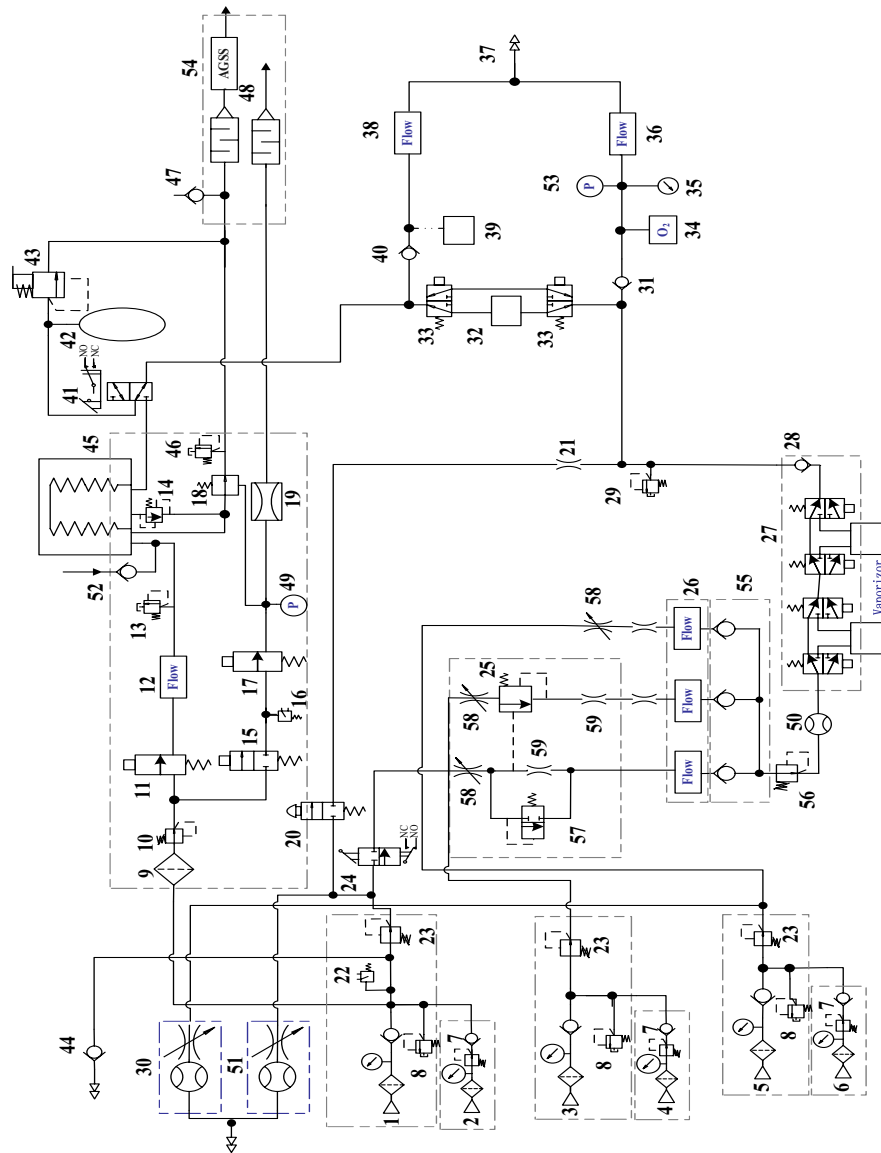

FIGURE D-1 Pneumatic Diagram of the A5/A3 System

NO.	DESCRIPTION	NO.	DESCRIPTION
1.	O ₂ Gas Pipeline Connection	33.	Bypass Valve
2.	O ₂ Gas Cylinder Connection	34.	O ₂ Sensor
3.	N ₂ O Gas Pipeline Connection	35.	Airway Pressure Gauge
4.	N ₂ O Gas Cylinder Connection	36.	Inspiratory Flow Sensor
5.	Air Gas Pipeline Connection	37.	Patient Connector
6.	Air Gas Cylinder Connection	38.	Expiratory Flow Sensor
7.	Gas Cylinder Pressure Regulator (360 kPa)	39.	Watertrap
8.	Pressure Relief Valve (758 kPa)	40.	Expiratory Check Valve
9.	Drive Gas Inlet Filter	41.	Auto/Manual Bag Switch
10.	Pressure Regulator (200 kPa)	42.	Breathing Bag
11.	Inspiratory Flow Control Valve	43.	APL Valve
12.	Inspiratory Flow Sensor	44.	Auxiliary O ₂ Gas Power Outlet
13.	Safety Valve (110 cmH ₂ O)	45.	Bellows
14.	Pop-off Valve	46.	Pressure Relief Valve (1kPa, 10 cmH ₂ O)
15.	PEEP Safety Valve	47.	Negative Pressure Check Valve (1 cmH ₂ O)
16.	Drive Gas Pressure Switch (140 kPa)	48.	Gas Container
17.	PEEP Proportional Valve	49.	Pressure Sensor
18.	Exhaust Valve	50.	Total Flowmeter
19.	Flow Restrictor	51.	Auxiliary Oxygen Flowmeter
20.	O ₂ Flush Valve	52.	Negative Pressure Check Valve
21.	Flow Restrictor	53.	Pressure Sensor
22.	O ₂ Pressure Switch (220 kPa)	54.	AGSS
23.	Pressure Regulating Valve (200 kPa)	55.	Check Valve
24.	System Switch	56.	Back Pressure Valve
25.	Oxygen Ratio Controller (ORC)	57.	Flow Compensation Valve
26.	Flow Control and Electronic Display Module	58.	Venturi Generator
27.	Dual Vaporizer Block	59.	Muffler
28.	Check Valve	60.	Negative Pressure Regulator
29.	Pressure Relief Valve (37.9 kPa)	61.	Negative Pressure Gauge
30.	Auxiliary Air Flowmeter	62.	Floating Overfill Protection Valve
31.	Inspiratory Check Valve	63.	Filter
32.	Sodalime Absorber Canister	64.	AG Watertrap

This page intentionally left blank.

E.0

Abbreviations, Symbols, and Units of Measure

Abbreviations, Symbols, and Units of Measure.....	E-2
Symbols	E-4
Units of Measure	E-4
Attention Symbols	E-5

E.1 Abbreviations

ABBREVIATION	DESCRIPTION
AA	anesthetic agent
AG	anesthetic gas
AGSS	anesthetic gas scavenging system
APL	airway pressure limit
Apnea Ti	inspiratory time for apnea backup breaths
BTPS	body temperature and pressure, saturated
C	compliance (C_{dyn})
CO ₂	carbon dioxide
Des	desflurane
ENF	enflurane
Et	end-tidal
EtAA	end-tidal anesthetic agent
EtCO ₂	end-tidal carbon dioxide concentration at expiration
EtDES	end-tidal desflurane concentration at expiration
EtENF	end-tidal enflurane concentration at expiration
EtHAL	end-tidal halothane concentration at expiration
EtISO	end-tidal isoflurane concentration at expiration
EtN ₂ O	end-tidal nitrous oxide concentration at expiration
EtO ₂	end-tidal oxygen concentration at expiration
EtSEV	end-tidal sevoflurane concentration at expiration
EUI	extended unique identifier
Fi	fractional concentration
FiAA	fractional concentration of anesthetic agent in inspired gas
FiCO ₂	fractional concentration of carbon dioxide in inspired gas
FiDES	fractional concentration of desflurane in inspired gas
FiENF	fractional concentration of enflurane in inspired gas
FiHAL	fractional concentration of halothane in inspired gas
FiISO	fractional concentration of isoflurane in inspired gas
FiN ₂ O	fractional concentration of nitrous oxide in inspired gas
FiO ₂	fractional concentration of oxygen in inspired gas
FiSEV	fractional concentration of sevoflurane in inspired gas
Flow	flow
HAL	halothane
I:E	ratio of inspiration time to expiration time
ISO	isoflurane
MAC	mean alveolar concentration
MEAN	mean pressure
Min Rate	minimum breath rate
MV	minute volume
N ₂ O	nitrous oxide
O ₂	oxygen

ABBREVIATION	DESCRIPTION
P_{insp}	pressure control level of inspiration
P_{limit}	pressure limit level
P_{limVG}	pressure limit level of volume guarantee
PAW	airway pressure
PCV	pressure control ventilation
PEAK	peak pressure
PEEP	positive end-expiratory pressure
PLAT	plateau pressure
PS	pressure support
ΔP	pressure support level added to PEEP
R	resistance
Rate	breath rate
SEV	sevoflurane
SIMV-PC	synchronized intermittent mandatory ventilation - pressure control
SIMV-VC	synchronized intermittent mandatory ventilation - volume control
SP	Spontaneous breathing
T_{insp}	time of inspiration
T_{pause}	percentage of inspiratory plateau time in inspiratory time
T_{slope}	time for the pressure to rise to target pressure
Trigger	trigger sensitivity
V_t	tidal volume
V_tG	tidal volume guarantee
VCV	volume control ventilation
VG	volume guarantee control

E.2 Symbols

SYMBOL	DESCRIPTION	SYMBOL	DESCRIPTION
-	minus	>	greater than
%	percent	≤	less than or equal to
/	per, divide, or	≥	greater than or equal to
≈	approximately	±	plus or minus
^	power	×	multiply
+	plus	©	copyright
=	equal to	™	trademark
<	less than	®	registered trademark

E.3 Units of Measure

UNIT OF MEASURE	DESCRIPTION	UNIT OF MEASURE	DESCRIPTION
A	Ampere, Amp	m	meter
Ah	Amp hour	mAh	microAmp hour
bpm	breath per minute	mbar	mbar
°C	degree Celsius	mg	milligram
cc	cubic centimeter	min	minute
cm	centimeter	ml, mL	milliliter
cmH ₂ O	centimeter of water	mm	millimeter
dB	decibel	mmHg	millimeter of mercury
°F	Fahrenheit	ms	millisecond
g	gram	mV	milliVolt
hr	hour	mW	milliWatt
Hz	Hertz	ppm	part per million
hPa	hectoPascal	s, sec	second
inch	inch	V	Volt
k	kilo	VA	Volt Amp
kg	kilogram	VAC	Volts alternating current
kPa	kiloPascal		Ohm
psi	pound-force per square inch	μA	microAmp
L, l	liter	μV	microVolt
lb	pound	W	Watt
nm	nanometer		

E.4 Attention Symbols

The following figures provide descriptions of symbols of Attention that are used on the device and/or within this manual.

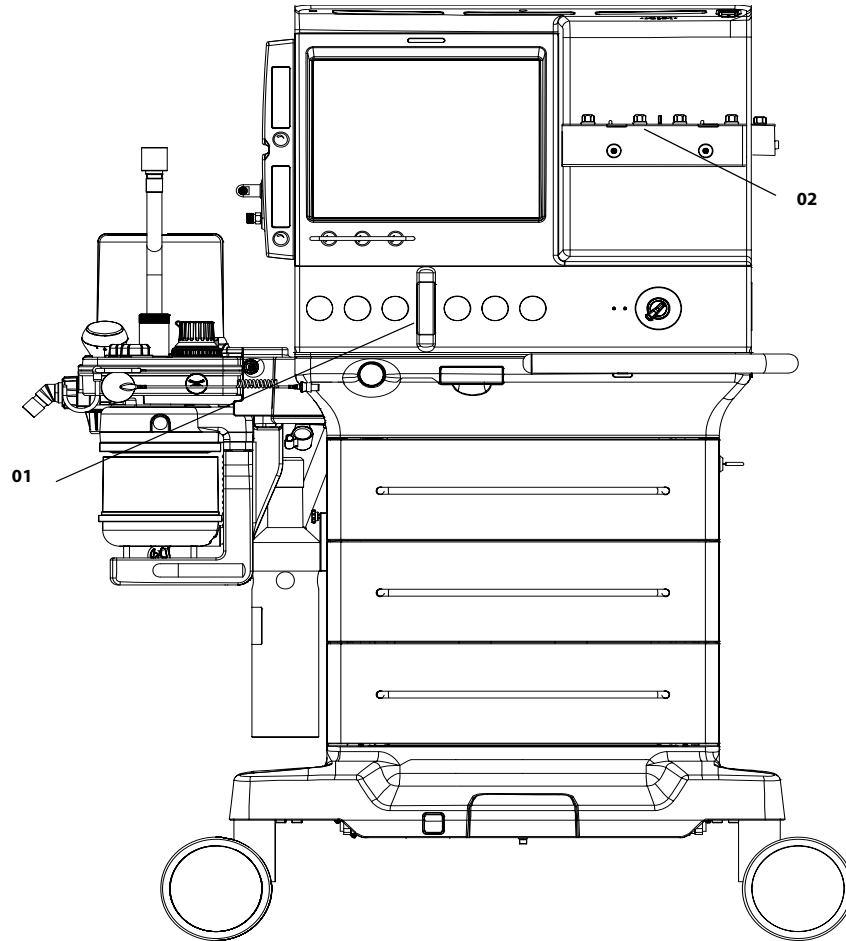

FIGURE E-1 Main Unit (Front View)

ATTENTION! NUMBER	DESCRIPTION
01	<p>Total Flowmeter: The total flowmeter is calibrated based on 100 % O₂. The accuracy of the flowmeter may degrade with other gas or mixed gas.</p> <p>When viewing the readings on the total flowmeter, keep your visual angle at the same level of the float. The reading of the scale may vary when viewed at a different angle.</p> <p>If the readings shown on the electronic flowmeters differ from that on the total flowmeter, the electronic flowmeter will prevail and the total flowmeter is an approximate value.</p>
02	<p>Only vaporizers with Selectatec Interlock-Systems may be used with the A5/A3 unit.</p> <p>Use vaporizers compliant to ISO 80601-2-13. See section A.9 (page A-5) "Vaporizers". Refer to the vaporizer manufacturer's Instructions For Use for filling or draining the vaporizer and other information.</p> <p>Use care in lifting and manipulating vaporizers during the mounting process as their weight may be greater than expected, based on their size and shape.</p>

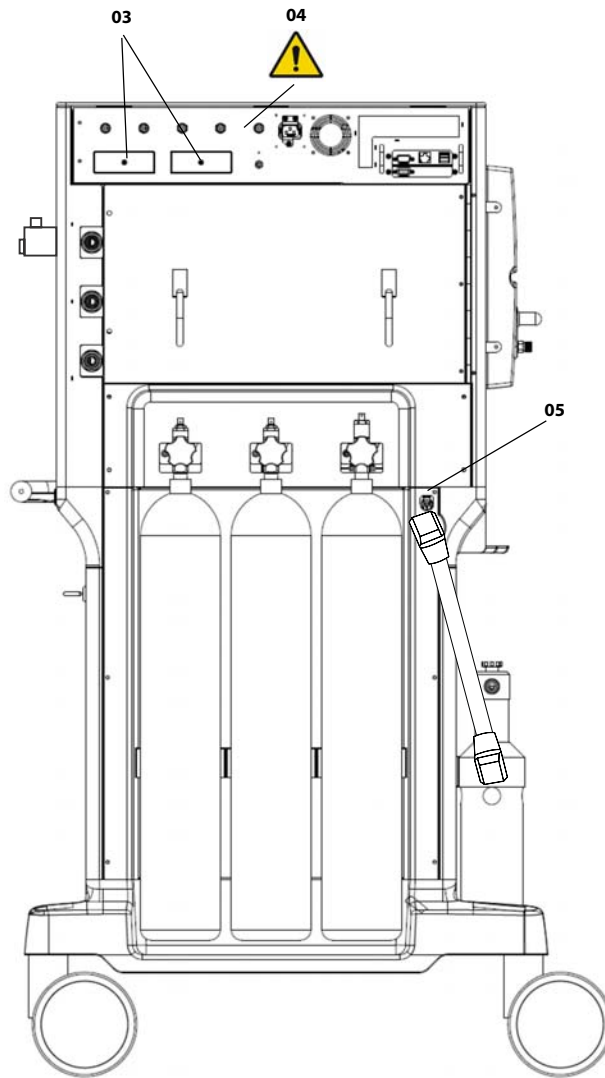

FIGURE E-2 Main Unit (Rear View)

ATTENTION! NUMBER	DESCRIPTION
03	Each auxiliary outlet is rated at 100 to 120 VAC @ 60 Hz.
04	Individual outlet current is limited to 3 A. Total mains output current is limited to 10 A.
05	Sample Line Exhaust Gas Inlet: Inlet for waste gas from an optionally attached gas module. Merges with the AGSS connector that connects to the AGSS.

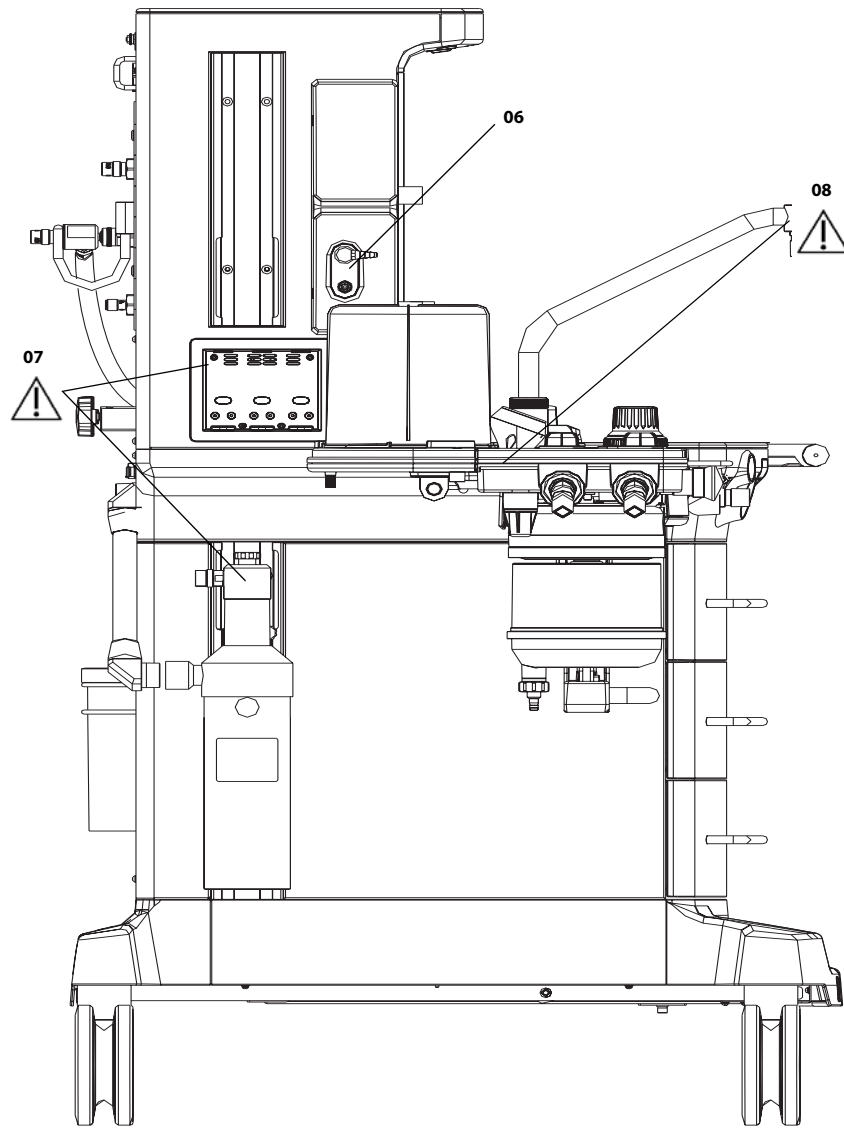

FIGURE E-3 Main Unit (Left View)

ATTENTION! NUMBER	DESCRIPTION
06	Auxiliary O ₂ /Air Gas Outlet: Nozzle (barbed connector) for auxiliary O ₂ /Air output. Combines the auxiliary O ₂ /Air flowmeters into a single output.
07	Maximum supporting weight: 25 kg at a maximum distance of 0.31 m.
08	Warning: Hot

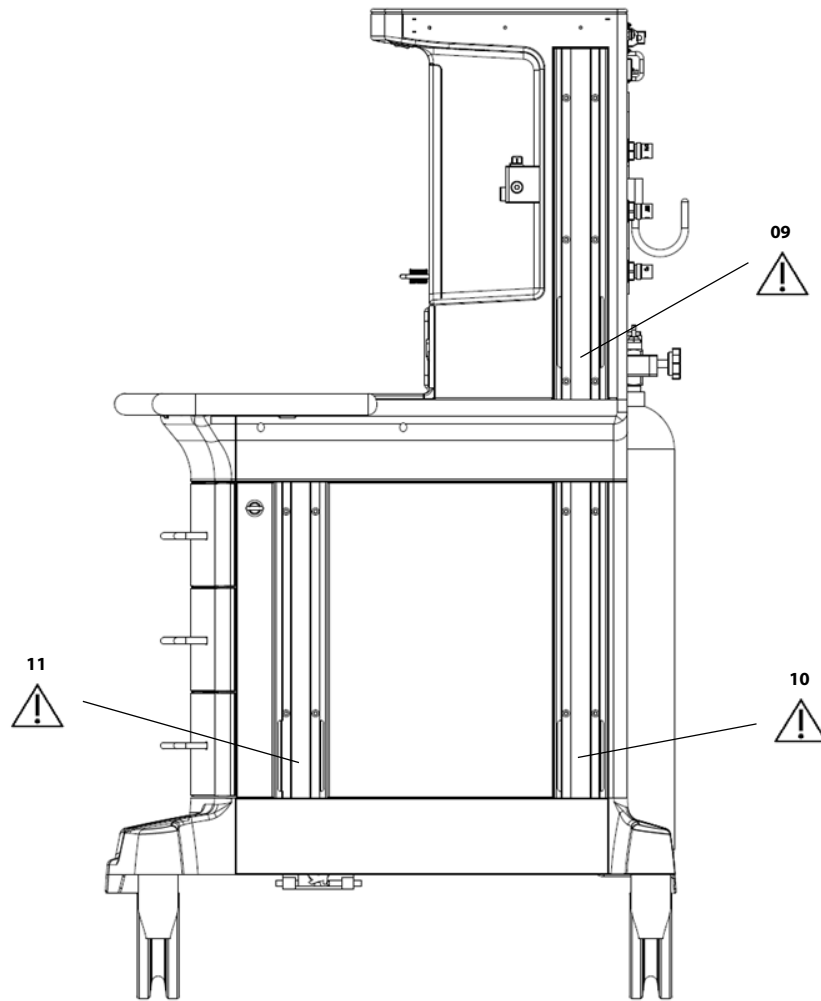

FIGURE E-4 Main Unit (Right View)

ATTENTION! NUMBER	DESCRIPTION
09	Maximum supporting weight: 25 kg at a maximum distance of 0.31 m.
10	Maximum supporting weight: 25 kg at a maximum distance of 0.31 m.
11	Maximum supporting weight: 25 kg at a maximum distance of 0.31 m.

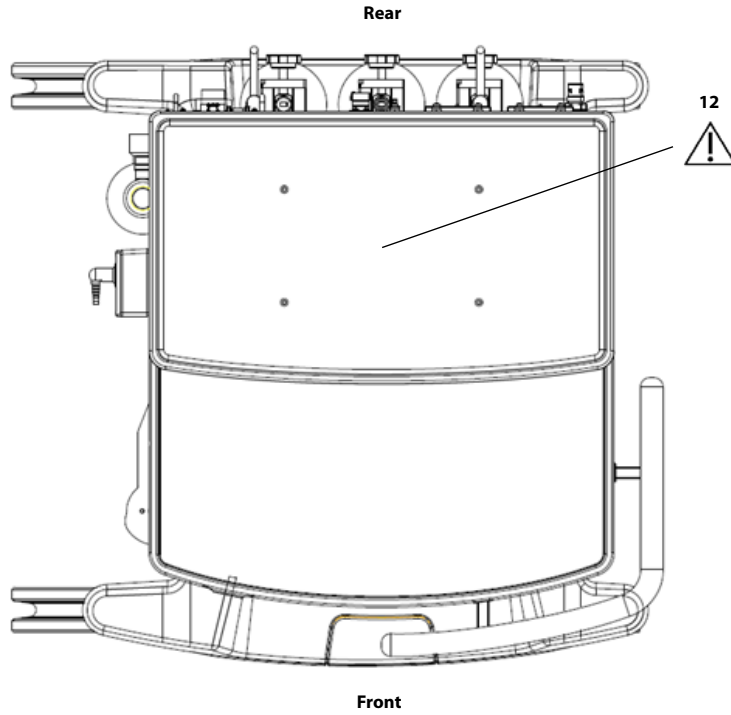

FIGURE E-5 Main Unit (Top View)

ATTENTION! NUMBER	DESCRIPTION
12	Top Shelf: 40 kg MAX. 88 lbs MAX.

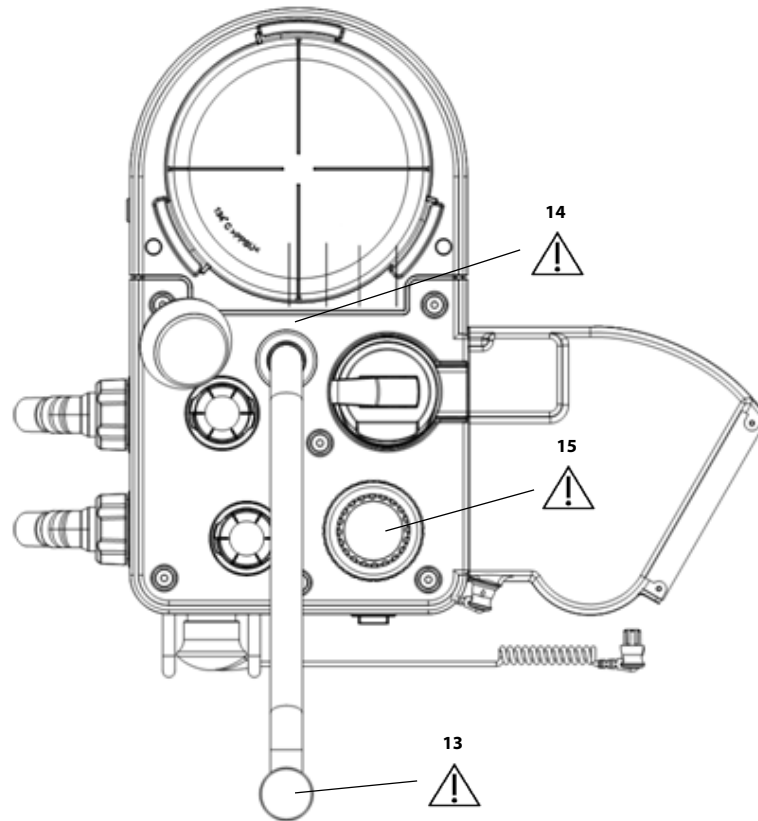

FIGURE E-6 Breathing System (Top View)

ATTENTION! NUMBER	DESCRIPTION
13	Do not push down on the bag arm forcefully or hang heavy objects onto it. Excessive weight may bend and damage the bag arm.
14	Autoclavable up to 134°C. Polyphenylsulfone (PPSU).
15	APL Valve: The APL valve and PAW gauge numerics are for reference only. Calibrated patient airway pressure is displayed on the user interface.

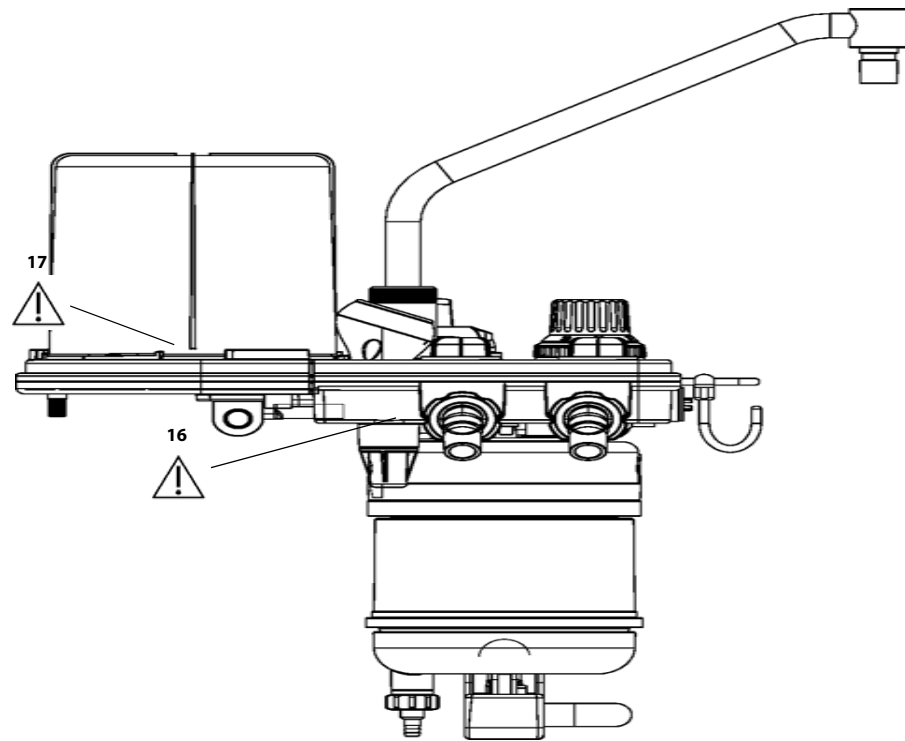

FIGURE E-7 Breathing System (Left View)

ATTENTION! NUMBER	DESCRIPTION
16	<p>134°C >PPSU<. Autoclavable up to 134°C.</p> <p>Operating the A5/A3 with a full water trap in the breathing system block does not allow the water to condense appropriately. The trap should be removed and emptied when filled with water.</p> <p>Operating without a water trap will cause the leak test to fail.</p>
17	<p>Bellows Dome: The bellows dome is a transparent cover with graduation marks from 300 to 1500. These marks are for qualitative purposes only. Tidal volume (VT) should be read exclusively from the display of the user interface. Delivered tidal volume (VT) is a combination of bellows displacement and fresh gas flow.</p>

F.0

Preparation for Malignant Hyperthermia Susceptible Patients

Malignant Hyperthermia Causes, Effects and Treatment	F-2
Malignant Hyperthermia Washout	F-2
Washout Procedure for Malignant Hyperthermia Susceptible Patients with A5 Anesthesia Delivery Systems	F-2
References	F-4

F.1 Malignant Hyperthermia Causes, Effects and Treatment

Malignant Hyperthermia (MH) is an uncommon inherited, life-threatening pharmacokinetic skeletal muscle disorder involving the dysregulated myoplasmic Ca^{2+} , hypercontracture, and hypermetabolism. Triggering factors include exposure to potent volatile anesthetic gases and depolarizing muscle relaxants.¹⁻⁴

The disorder is characterized by skeletal muscle hypermetabolism, which is related to an uncontrolled release of calcium from skeletal muscle sarcoplasmic reticulum. These results in increased carbon dioxide production, increased core temperature, and generalized muscle rigidity with resultant rhabdomyolysis, acidosis, and hyperkalemia. If untreated, MH may lead to cardiac arrhythmia, multiorgan system failure, and death.^{2,3}

MH has had a reported mortality rate decrease from 70%-80% to less than 5% if preventive measures and effective management are adopted.² The early therapy requires immediate discontinuation of all the triggering agents, adequate oxygenation and ventilation, institution of aggressive cooling measures, administration of dantrolene sodium, and appropriate treatment for hyperkalemia. Ultimately, the only effective treatment for an MH crisis is the intravenous administration of dantrolene sodium and supportive therapy to combat the symptoms.^{1,2}

F.2 Malignant Hyperthermia Washout

To prevent MH in susceptible patients or to treat MH occurring during inhalational anesthesia, all inhalational anesthetics should be removed from the anesthesia machine. Avoidance of potent vapor anesthetics, such as Sevoflurane, Isoflurane or Desflurane,⁴ in patient cases is more challenging, based on the complex newer generation anesthesia machines and breathing circuits which retain anesthetic vapors long after discontinuation. The ultimate goal is to eliminate the residual anesthetic vapor concentration within the breathing system. The recommended instructions for clearing residual anesthetic gases include removal or disabling of vaporizers, flushing the machine using the ventilator with a fresh gas flow rate more than 10 L/min, replacement of the carbon dioxide absorbent and anesthesia circuit.^{1,3}

F.3 Washout Procedure for Malignant Hyperthermia Susceptible Patients with A5 Anesthesia Delivery Systems

The minimum inhaled concentration for triggering an episode of MH is unknown. Studies assumed a trace concentration of inhalational anesthetics below 5 ppm to be safe.⁵⁻⁸ the following steps are recommended to prepare a A5 anesthesia system for an MH-susceptible patient.

1. Turn off and remove all the vaporizers from the anesthesia system to prevent their inadvertent use.
2. Remove the carbon dioxide absorbent, breathing bag and the entire patient breathing circuit, filters, sampling line, water trap, and airway adapter and replace with new circuit and parts, connect a new breathing bag or test lung to the patient Y-piece.
3. Ventilate for a minimum of 40 minutes using mechanical ventilation with the following settings, 700 ml tidal volume, I:E ratio of 1:2, 12 breaths/minute, PEEP Off, and oxygen fresh gas flow rate of 15 L/min.

4. Upon completion of the 40 minute flush, remove the patient breathing circuit. Allow the bellows to deflate completely. Replace with a new patient breathing circuit, including bag and new carbon dioxide absorbent. Perform the pre-operative checkout.
5. Maintain the oxygen fresh gas flow rate of 15 L/min throughout the case to functionally create a non-rebreathing system and minimize rebound of volatile concentration at low fresh gas flow rates.

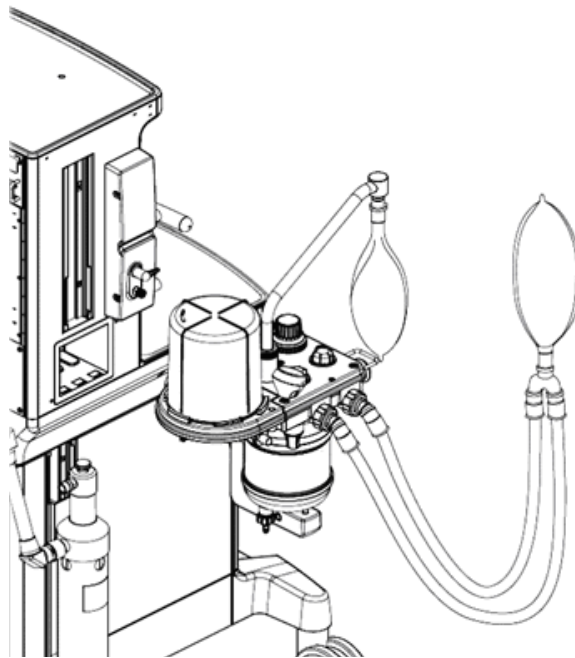
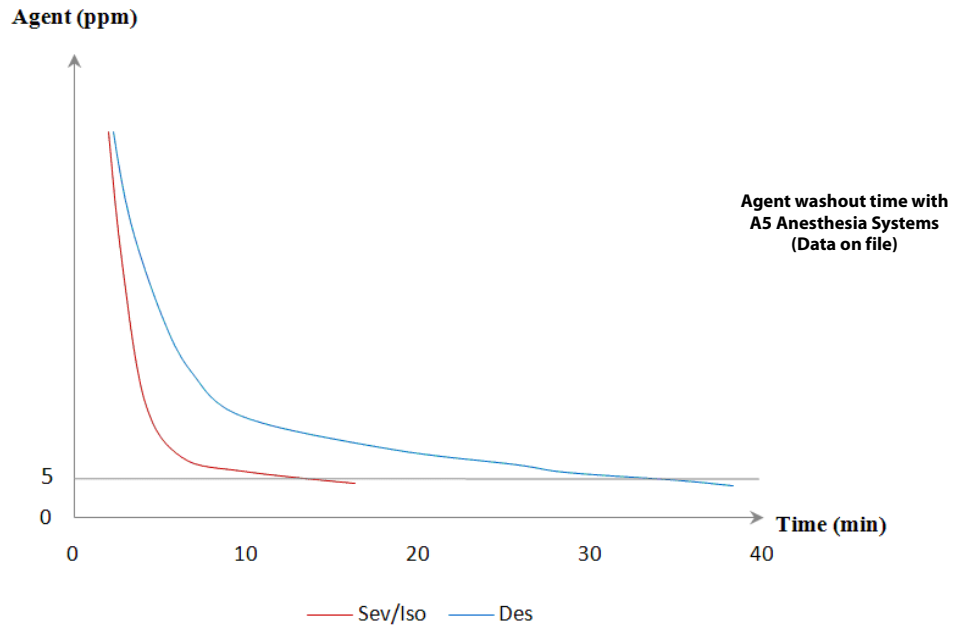

FIGURE F-1 Washout Procedure for Malignant Hyperthermia Susceptible Patients

The following guidelines are recommended by the Malignant Hyperthermia Association of the United States (MHAUS)*

Preparation of Anesthesia Workstations to Anesthetize MH Susceptible Patients

Recommendations (4 alternatives):

- 1.** Flush and prepare workstation according to manufacturer's recommendations or published studies; this may take 10 to >90 minutes. Most studies also physically disconnect vaporizers from the workstation; use a new, disposable breathing circuit; and replace the carbon dioxide absorbent. During the case, fresh gas flow should be kept at 10 liters per minute to avoid "rebound phenomenon" (increased release of residual volatile anesthetic agent when fresh gas flow is reduced after a set period of flushing). or
- 2.** Use commercially available charcoal filters that have been shown to remove trace levels of volatile anesthetic agents within 10 minutes of application, without additional preparation. These filters may have to be regularly replaced during the anesthetic.⁺⁺ or
- 3.** If available, use a dedicated "vapor free" machine for MH-susceptible patients. The machine must be regularly maintained and safety-checked. or
- 4.** If appropriate to the institution, use an ICU ventilator that has never been exposed to volatile anesthetic agents.

For further information contact the Malignant Hyperthermia Association of the United States at <http://www.mhaus.org/>

*: Guidelines are excerpted from the MHAUS website and do not replace the indicated instructions for preparation of the A5.

⁺⁺: This method has not been tested with A5.

F.4 References

- 1.** Hopkins PM. Malignant hyperthermia: pharmacology of triggering. *Br J Anaesth.* 2011 Jul; 107 (1): 48-56.
- 2.** Kim DC. Malignant hyperthermia. *Korean J Anesthesiol.* 2012 Nov; 63 (5): 391-401.
- 3.** Kim TW, Nemergut ME. Preparation of modern anesthesia workstations for malignant hyperthermia-susceptible patients: a review of past and present practice. *Anesthesiology.* 2011 Jan;114 (1):205-212.
- 4.** Schuster F, Johannsen S, Schneiderbanger D, Roewer N. Evaluation of suspected malignant hyperthermia events during anesthesia. *BMC Anesthesiology* 2013, 13: 24.
- 5.** Gunter JB, Ball S, Tan-Win S. Preparation of the Dräger Fabjus anesthesia machine for the malignant -hyperthermia susceptible patient. *Anesth Analg* 2008; 107: 1936-45.
- 6.** Reber A, Schumacher P, Urwyler A. Effects of three different types of management on the elimination kinetics of volatile anaesthetics. Implications for malignant hyperthermia treatment. *Anaesthesia* 1993; 48: 862-5.
- 7.** Crawford MW, Prinzhausen H, Petroz GC. Accelerating the washout of inhalational anesthetics from the Dräger Primus anesthetic workstation. *Anesthesiology* 2007; 106:289-94.
- 8.** Prinzhausen H, Crawford MW, O'Rourke J, Petroz GC. Preparation of the Dräger Primus anesthetic machine for malignant hyperthermia-susceptible patients. *Can J Anesth* 2006; 53: 885-90.

