

TECHNICAL PRODUCT GUIDE 2021



— BRITANNIA —

Cast Iron Gutters



Plain Half Round



Beaded Half Round



Victorian Ogee

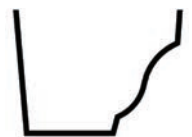

Moulded No 46 Ogee

	4"	4.5"	5"	6"	5" x 4"	6" x 4"
Plain Half Round	✓	✓	✓	✓		
Beaded Half Round		✓	✓			
Victorian Ogee		✓	✓			
Moulded No 46 Ogee					✓	✓

Cast Iron gutters are the traditional choice for durable and aesthetically pleasing systems. Ideal for replacing existing cast iron products on Heritage and Listed building projects.

- Traditional sand cast iron.
- Mimics traditional cast iron styles.
- Manufactured to BS 460:1964.
- Complies to all Listed building, Heritage and Conservation requirements.
- Supplied transit primed or factory applied wet paint finish in semi gloss black.
- Can be painted to a specific RAL/BS colour on request.
- Life expectancy - over 100 years.
- Can be recycled at the end of its useful life.
- Gutters are wet sealed with bolted joints and a range of fixing options.





System Overview

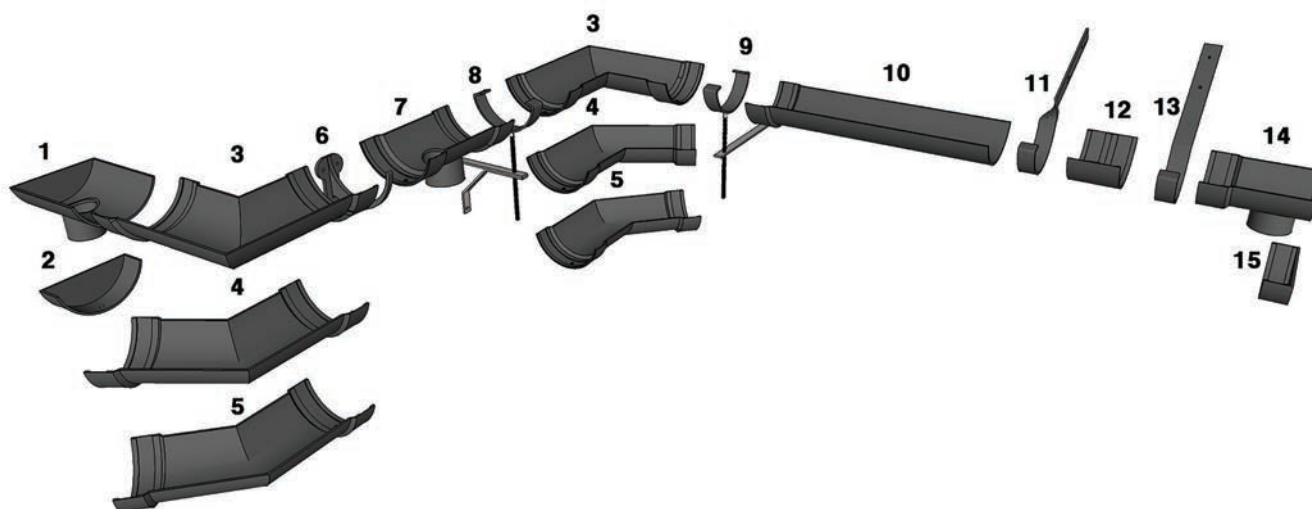

Number	Item	Number	Item
1	Internal Stopend	8	Side Fix Rafter Bracket
2	90° Universal Angle	9	Gutter Length
3	120° Universal Angle	10	Top Fix Rafter Bracket
4	135° Universal Angle	11	Union Connector
5	Fascia Bracket	12	Rise and Fall Bracket
6	Running Outlet	13	External Stopend
7	Rise and Fall Bracket with Stay		

Gutter Lengths

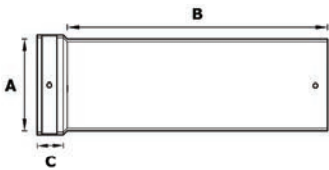

GUTTER SIZE A	B	C	DEPTH	PRODUCT CODE
100 (4")	1830	45	50	BI/HR40/6FT
114 (4½")	1830	45	55	BI/HR45/6FT
125 (5")	1830	45	60	BI/HR50/6FT
150 (6")	1830	45	65	BI/HR60/6FT



90° Universal Angle

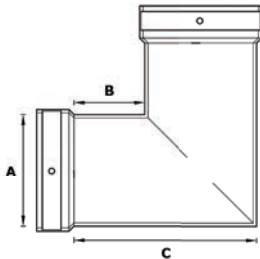

GUTTER SIZE A	B	C	PRODUCT CODE
100 (4")	60	180	BI/HR40/A/90
114 (4½")	65	184	BI/HR45/A/90
125 (5")	56	189	BI/HR50/A/90
150 (6")	71	235	BI/HR60/A/90



120° Universal Angle

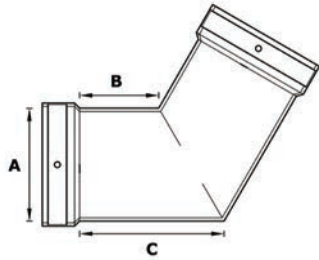

GUTTER SIZE A	B	C	PRODUCT CODE
100 (4")	60	129	BI/HR40/A/120
114 (4½")	60	129	BI/HR45/A/120
125 (5")	60	137	BI/HR50/A/120
150 (6")	72	235	BI/HR60/A/120



135° Universal Angle

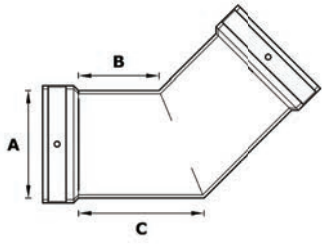

GUTTER SIZE A	B	C	PRODUCT CODE
100 (4")	62	113	BI/HR40/A/135
114 (4½")	62	113	BI/HR45/A/135
125 (5")	67	121	BI/HR50/A/135
150 (6")	72	140	BI/HR60/A/135



Running Outlet

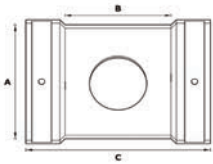

GUTTER SIZE A	OUTLET SIZE	B	C	PRODUCT CODE
100 (4")	Ø2.5"	125	234	BI/HR40/RO/25
100 (4")	Ø3"	125	234	BI/HR40/RO/30
114 (4½")	Ø2.5"	125	234	BI/HR45/RO/25
114 (4½")	Ø3"	125	234	BI/HR45/RO/30
125 (5")	Ø2.5"	125	234	BI/HR50/RO/25
125 (5")	Ø3"	125	234	BI/HR50/RO/30
125 (5")	Ø4"	125	234	BI/HR50/RO/40
150 (6")	Ø2.5"	142	251	BI/HR60/RO/25
150 (6")	Ø3"	142	251	BI/HR60/RO/30
150 (6")	Ø4"	142	251	BI/HR60/RO/40



Dropend Outlet External

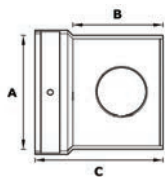

GUTTER SIZE A	OUTLET SIZE	B	C	PRODUCT CODE
100 (4")	Ø2.5"	125	234	BI/HR40/DE/25/E
100 (4")	Ø3"	125	234	BI/HR40/DE/30E
114 (4½")	Ø2.5"	125	234	BI/HR45/DE/25/E
114 (4½")	Ø3"	125	234	BI/HR45/DE/30E
125 (5")	Ø2.5"	125	234	BI/HR50/DE/30E
125 (5")	Ø3"	125	234	BI/HR50/DE/30E



Dropend Outlet Internal

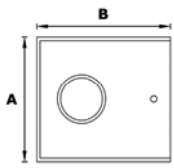

GUTTER SIZE A	OUTLET SIZE	B	PRODUCT CODE
100 (4")	Ø2.5"	172	BI/HR40/DE/25/I
100 (4")	Ø3"	172	BI/HR40/DE/30I
114 (4½")	Ø2.5"	172	BI/HR45/DE/25/I
114 (4½")	Ø3"	172	BI/HR45/DE/30I
125 (5")	Ø2.5"	172	BI/HR50/DE/30I
125 (5")	Ø3"	172	BI/HR50/DE/30I

Stopends Internal/External

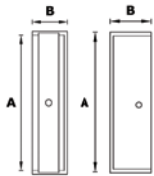

GUTTER SIZE A	B	PRODUCT CODE EXT	PRODUCT CODE INT
100 (4")	50	BI/HR40/SE/EX	BI/HR40/SE/IN
114 (4½")	50	BI/HR45/SE/EX	BI/HR45/SE/IN
125 (5")	50	BI/HR50/SE/EX	BI/HR50/SE/IN
150 (6")	50	BI/HR60/SE/EX	BI/HR60/SE/IN

Union Connector

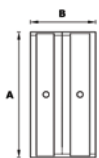

GUTTER SIZE A	B	PRODUCT CODE
100 (4")	98	BI/HR40/UC
114 (4½")	98	BI/HR45/UC
125 (5")	98	BI/HR50/UC
150 (6")	100	BI/HR60/UC

Fascia Bracket

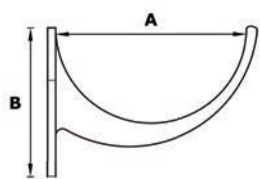

GUTTER SIZE A	B	PRODUCT CODE
100 (4")	90	BI/HR40/FB/CI
114 (4½")	90	BI/HR45/FB/CI
125 (5")	110	BI/HR50/FB/CI
150 (6")	112	BI/HR60/FB/CI



Top Fix Rafter Bracket

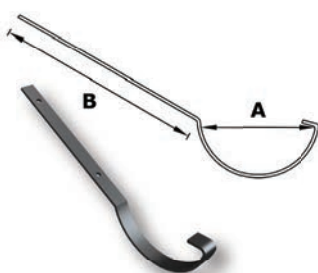

GUTTER SIZE A	B	PRODUCT CODE
100 (4")	250	BI/HR40/RB/TF
114 (4½")	250	BI/HR45/RB/TF
125 (5")	250	BI/HR50/RB/TF
150 (6")	250	BI/HR60/RB/TF

Side Fix Rafter Bracket

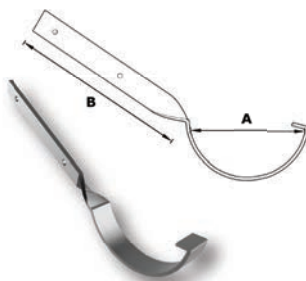

GUTTER SIZE A	B	PRODUCT CODE
100 (4")	200	BI/HR40/RB/SF
114 (4½")	200	BI/HR45/RB/SF
125 (5")	200	BI/HR50/RB/SF
150 (6")	200	BI/HR60/RB/SF

Trueline, for all your aluminium roofline requirements - fascia, soffit, cappings, copings and bespoke pressings.

Call us today on
0116 289 4400



Rise and Fall Bracket

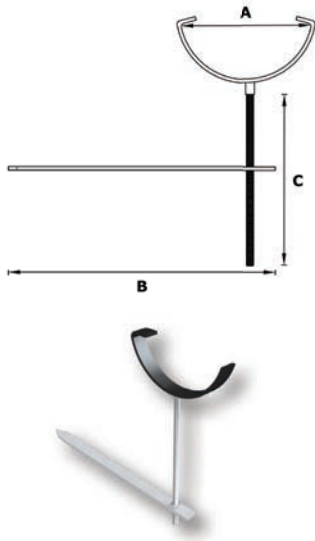

GUTTER SIZE A	B	C	PRODUCT CODE
100 (4")	300	140	BI/HR40/R&F/GS
114 (4½")	300	140	BI/HR45/R&F/GS
125 (5")	300	140	BI/HR50/R&F/GS
150 (6")	300	140	BI/HR60/R&F/GS

Rise & Fall Bracket with Stay

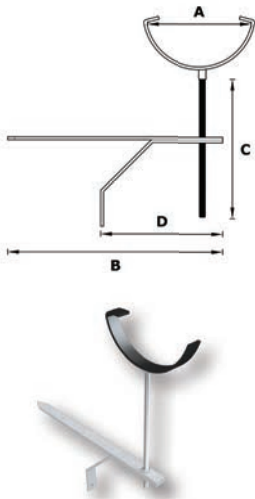

GUTTER SIZE A	B	C	D	PRODUCT CODE
100 (4")	300	140	220	BI/HR40/R&F/WS
114 (4½")	300	140	220	BI/HR45/R&F/WS
125 (5")	300	140	220	BI/HR50/R&F/WS
150 (6")	300	140	220	BI/HR60/R&F/WS

Our national team of account managers, can assist with drawing take offs, quotations and on-site advice.

Call us today on **0116 289 4400**



System Overview

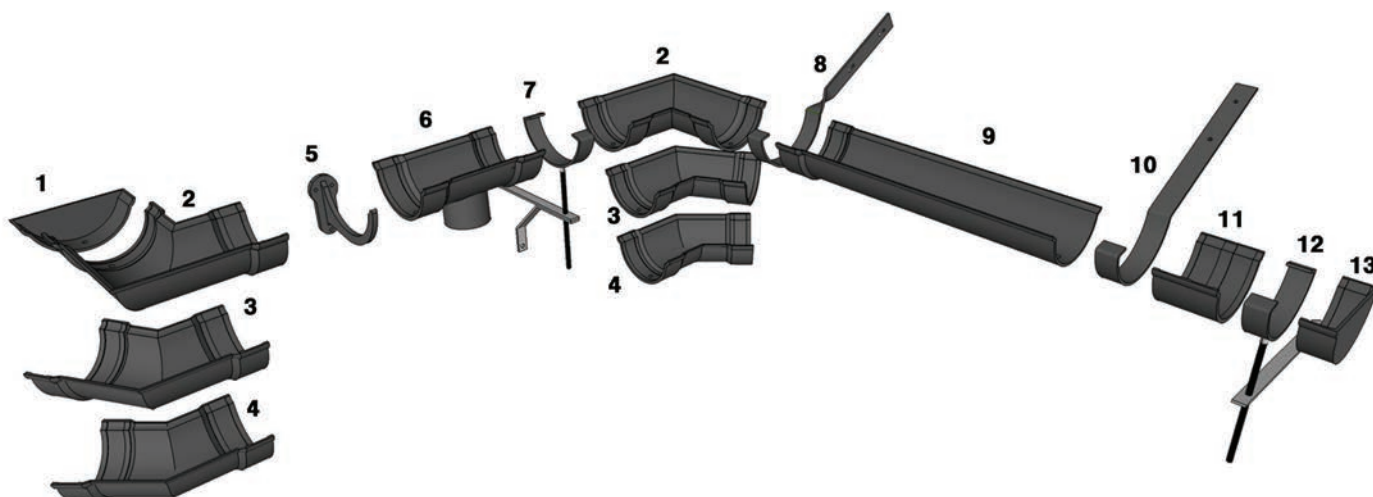

Number	Item	Number	Item
1	Internal Stopend	8	Side Fix Rafter Bracket
2	90° Universal Angle	9	Gutter Length
3	120° Universal Angle	10	Top Fix Rafter Bracket
4	135° Universal Angle	11	Union Connector
5	Fascia Bracket	12	Rise and Fall Bracket
6	Running Outlet	13	External Stopend
7	Rise and Fall Bracket with Stay		

Gutter Lengths

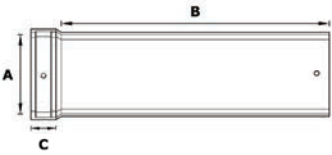

GUTTER SIZE A	B	C	DEPTH	PRODUCT CODE
114 (4½")	1880	48	60	BI/BHR45/6FT
125 (5")	1880	48	65	BI/BHR50/6FT



90° Universal Angle

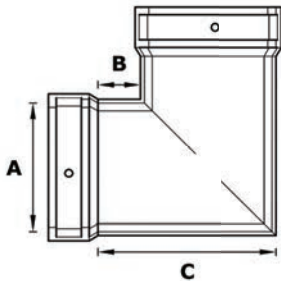

GUTTER SIZE A	B	C	PRODUCT CODE
114 (4½")	60	192	BI/BHR45/A/90
125 (5")	50	192	BI/BHR50/A/90



120° Universal Angle

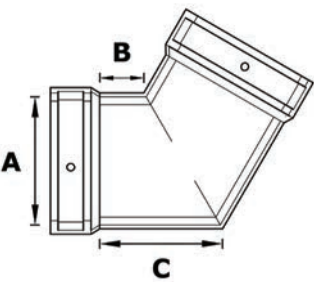

GUTTER SIZE A	B	C	PRODUCT CODE
114 (4½")	65	140	BI/BHR45/A/120
125 (5")	60	140	BI/BHR50/A/120



135° Universal Angle

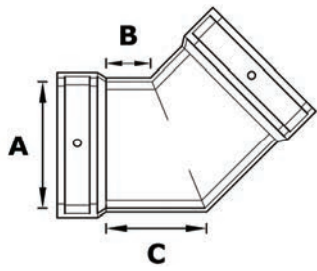

GUTTER SIZE A	B	C	PRODUCT CODE
114 (4½")	60	113	BI/BHR45/A/135
125 (5")	56	116	BI/BHR50/A/135



Running Outlet

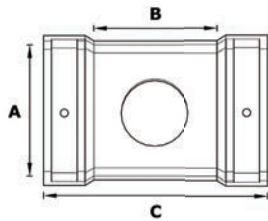

GUTTER SIZE A	OUTLET SIZE	B	C	PRODUCT CODE
114 (4½")	Ø2.5"	125	240	BI/BHR45/RO/25
114 (4½")	Ø3"	125	240	BI/BHR45/RO/30
125 (5")	Ø2.5"	125	240	BI/BHR50/RO/25
125 (5")	Ø3"	125	240	BI/BHR50/RO/30
125 (5")	Ø4"	125	240	BI/BHR50/RO/40



Stopend Internal/External

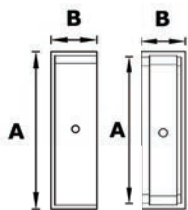

GUTTER SIZE A	B	INT/EXT	PRODUCT CODE
114 (4½")	50	EXTERNAL	BI/BHR45/SE/EX
114 (4½")	50	INTERNAL	BI/BHR45/SE/IN
125 (5")	50	EXTERNAL	BI/BHR50/SE/EX
125 (5")	50	INTERNAL	BI/BHR50/SE/IN



Union Connector

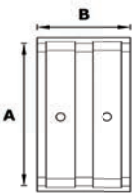

GUTTER SIZE A	B	PRODUCT CODE
114 (4½")	102	BI/BHR45/UC
125 (5")	102	BI/BHR50/UC

Fascia Bracket

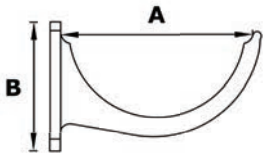

GUTTER SIZE A	B	PRODUCT CODE INT
114 (4½")	93	BI/BHR45/FB/CI
125 (5")	98	BI/BHR50/FB/CI

Top Fix Rafter Bracket

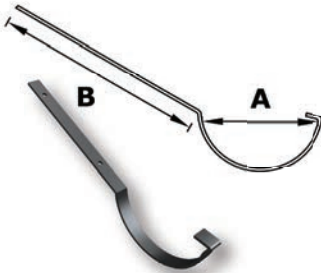

GUTTER SIZE A	B	PRODUCT CODE
114 (4½")	250	BI/BHR45/RB/TF
125 (5")	250	BI/BHR50/RB/TF

Side Fix Rafter Bracket

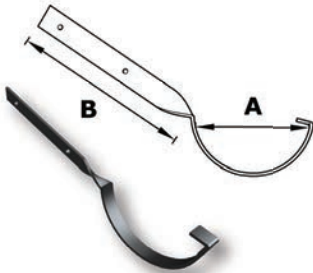

GUTTER SIZE A	B	PRODUCT CODE
114 (4½")	200	BI/BHR45/RB/SF
125 (5")	200	BI/BHR50/RB/SF

Rise and Fall Bracket

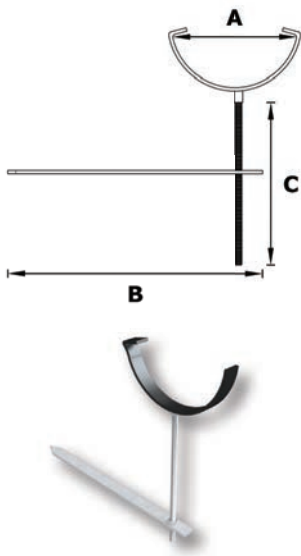

GUTTER SIZE A	B	C	PRODUCT CODE
114 (4½")	300	140	BI/BHR45/R&F/GS
125 (5")	300	140	BI/BHR50/R&F/GS

Rise and Fall Bracket with Spike and Stay

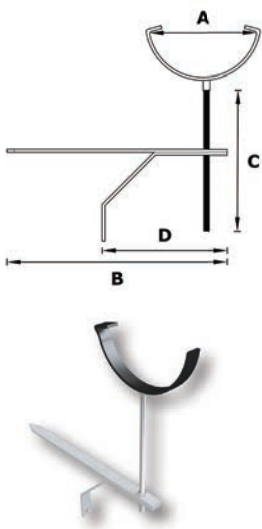

GUTTER SIZE A	B	C	D	PRODUCT CODE
114 (4½")	300	140	220	BI/BHR45/R&F/WS
125 (5")	300	140	220	BI/BHR50/R&F/WS

Need help with rainfall calculations?

We can help.

Simply provide us with a few dimensions and we will do the rest for you.

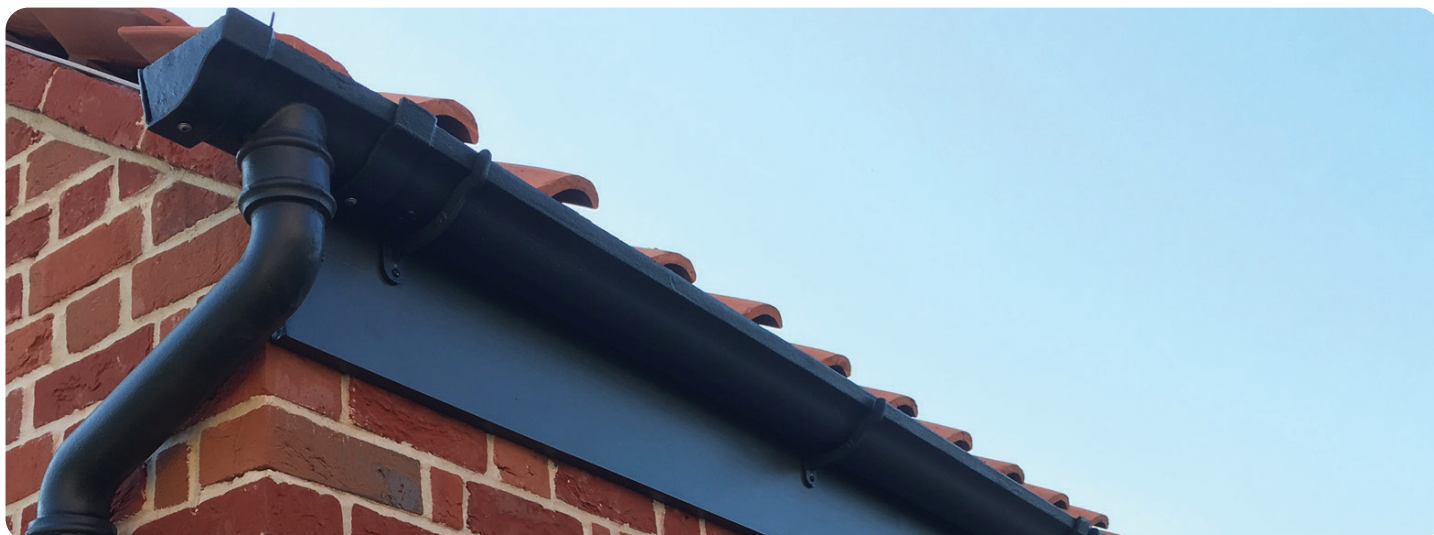

System Overview

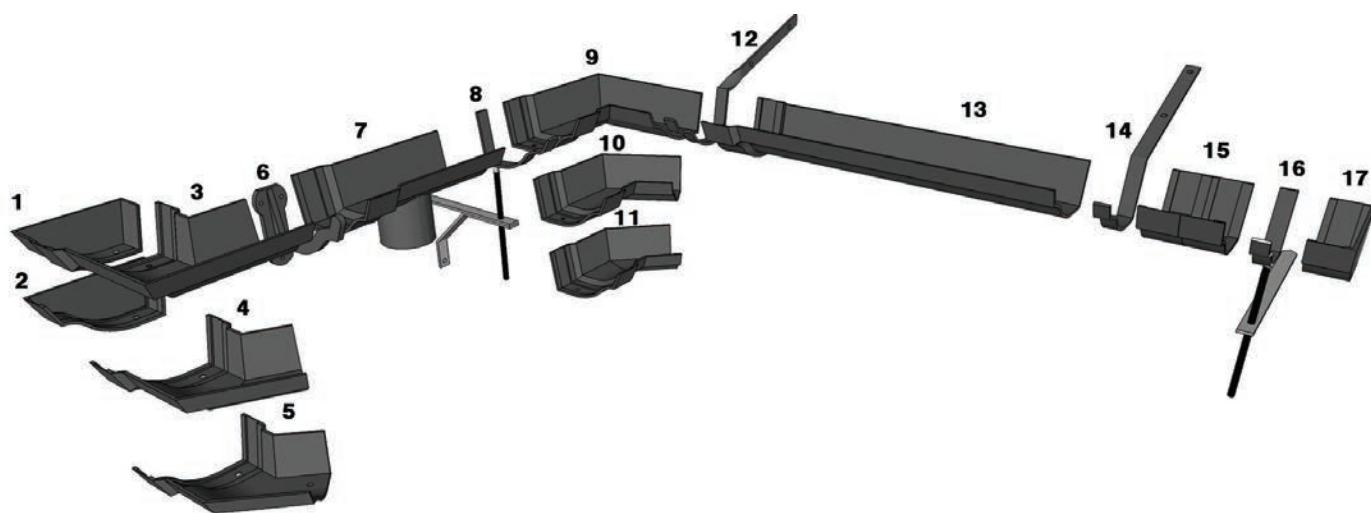

Number	Item	Number	Item
1	Internal Left Hand Stopend	10	120° Internal Corner
2	External Left Hand Stopend	11	135° Internal Corner
3	90° External Corner	12	Side Fix Rafter Bracket
4	120° External Corner	13	Gutter Length
5	135° External Corner	14	Top Fix Rafter Bracket
6	Fascia Bracket	15	Union Connector
7	Running Outlet	16	Rise and Fall Bracket
8	Rise and Fall Bracket with Stay	17	External Right Hand Stopend
9	90° Internal Corner		

Gutter Lengths

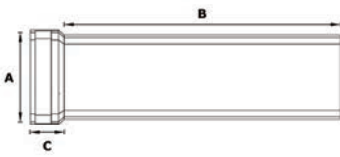

GUTTER SIZE A	B	C	DEPTH	PRODUCT CODE
114 (4½")	1830	45	68.5	BI/OG45/6FT
125 (5")	1830	45	73.5	BI/OG50/6FT



90° External Angle

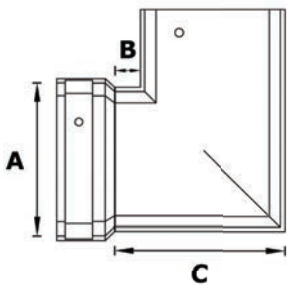

GUTTER SIZE A	B	C	PRODUCT CODE
114 (4½")	136	184	BI/OG45/EA/90
125 (5")	160	211	BI/OG50/EA/90

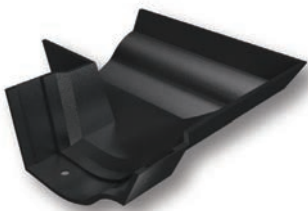

90° Internal Angle

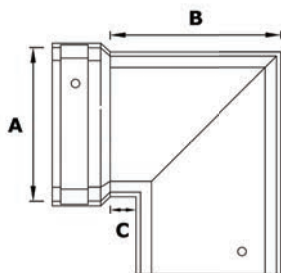

GUTTER SIZE A	B	C	PRODUCT CODE
114 (4½")	136	184	BI/OG45/IA/90
125 (5")	160	140	BI/OG50/IA/90

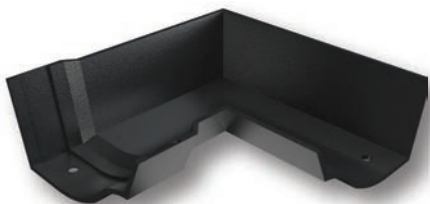

120° External Angle

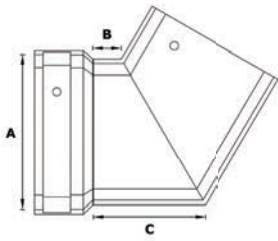

GUTTER SIZE A	B	C	PRODUCT CODE
114 (4½")	27	74	BI/OG45/EA/120
125 (5")	27	57	BI/OG50/EA/120



120° Internal Angle

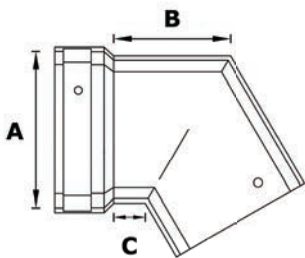

GUTTER SIZE A	B	C	PRODUCT CODE
114 (4½")	94	145	BI/OG5/EA/120
125 (5")	106	136	BI/OG50/EA/120

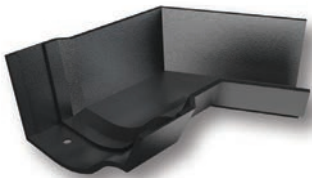

135° External Angle

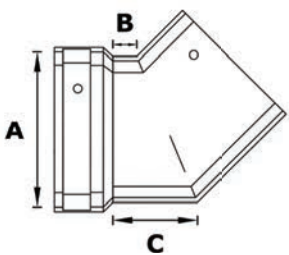

GUTTER SIZE A	B	C	PRODUCT CODE
114 (4½")	23	73	BI/OG45/EA/135
125 (5")	22	74	BI/OG50/EA/135



135° Internal Angle

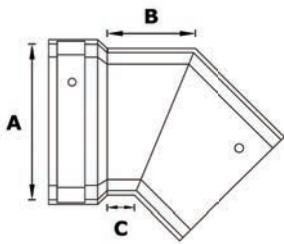

GUTTER SIZE A	B	C	PRODUCT CODE
114 (4½")	74	124	BI/OG45/EA/135
125 (5")	78	130	BI/OG50/EA/135



Running Outlet

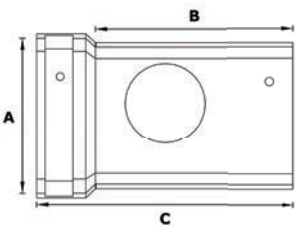

GUTTER SIZE A	OUTLET SIZE	B	C	PRODUCT CODE
114 (4½")	Ø2.5"	126	234	BI/OG45/RO/25
114 (4½")	Ø3"	126	234	BI/OG45/RO/30
125 (5")	Ø2.5"	125	234	BI/OG50/RO/25
125 (5")	Ø3"	125	234	BI/OG50/RO/30
125 (5")	Ø4"	125	230	BI/OG50/RO/40

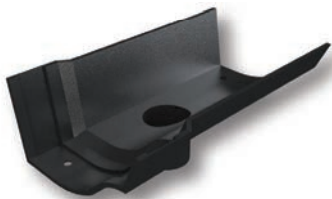

Stopend Right/Left Hand External

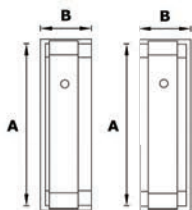

GUTTER SIZE A	B	PRODUCT CODE
114 (4½")	50.5	BI/OG45/SE/RE
114 (4½")	50.5	BI/OG45/SE/LE
125 (5")	50.5	BI/BHR50/SE/RE
114 (4½")	50.5	BI/OG45/SE/LE



Stopend Left Internal



GUTTER SIZE A	B	PRODUCT CODE
114 (4½")	50.5	BI/OG45/SE/LI
125 (5")	50.5	BI/OG50/SE/LI

Union Connector

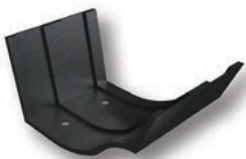
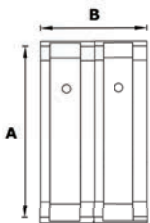

GUTTER SIZE A	B	PRODUCT CODE
114 (4½")	98	BI/OG5/UC
125 (5")	98	BI/OG50/UC

Fascia Bracket

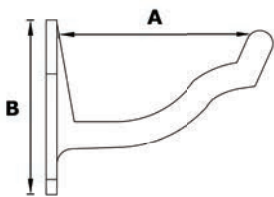

GUTTER SIZE A	B	PRODUCT CODE
114 (4½")	112	BI/OG45/FB/CI
125 (5")	117	BI/OG50/FB/CI

Top Fix Rafter Bracket

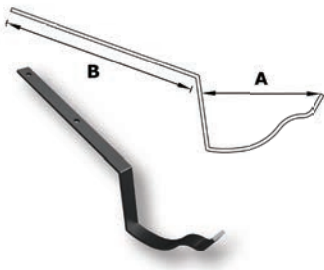

GUTTER SIZE A	B	PRODUCT CODE
114 (4½")	250	BI/OG45/RB/TF
125 (5")	250	BI/OG50/RB/TF

Side Fix Rafter Bracket

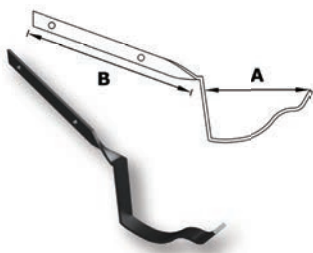

GUTTER SIZE A	B	PRODUCT CODE
114 (4½")	200	BI/OG45/RB/SF
125 (5")	200	BI/OG50/RB/SF

Rise and Fall Bracket

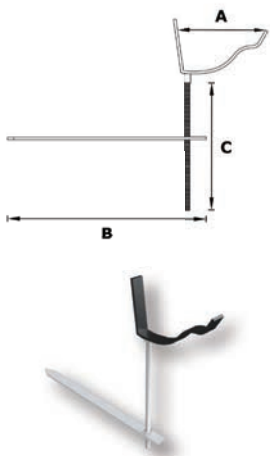

GUTTER SIZE A	B	C	PRODUCT CODE
114 (4½")	300	140	BI/OG45/R&F/GS
125 (5")	300	140	BI/OG50/R&F/GS

Rise and Fall Bracket with Stay

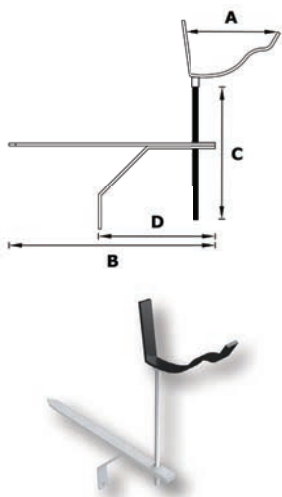

GUTTER SIZE A	B	C	D	PRODUCT CODE
114 (4½")	300	140	220	BI/HR45/R&F/WS
125 (5")	300	140	220	BI/HR50/R&F/WS



System Overview

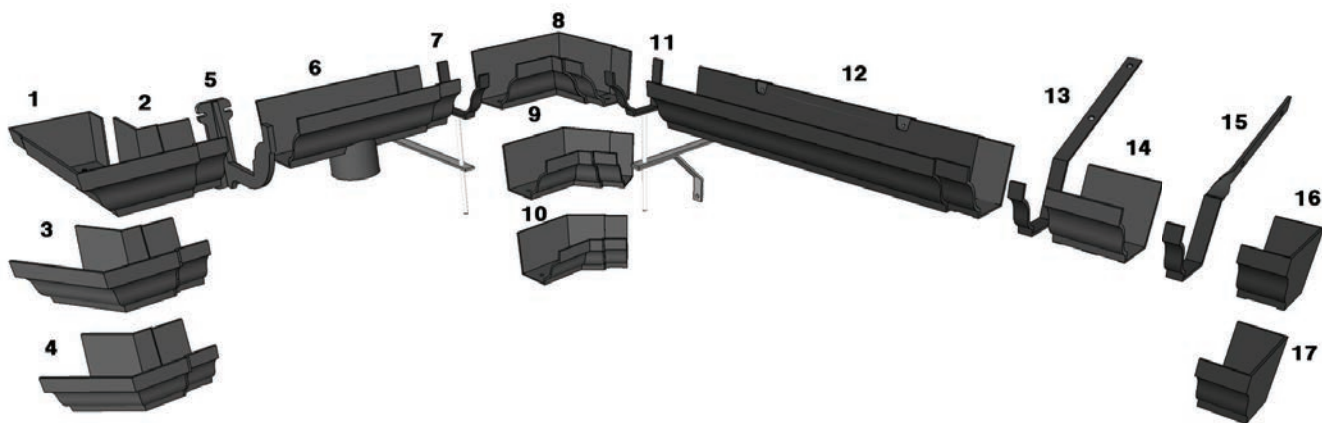

Number	Item	Number	Item
1	Internal Left Hand stopend	10	135° Internal Angle
2	90° External Angle	11	Rise and Fall Bracket with Stay
3	120° External Angle	12	Gutter Length
4	135° External Angle	13	Top Fix Rafter Bracket
5	Fascia Bracket	14	Union Connector
6	Running Outlet	15	Side Fix Rafter Bracket
7	Rise and Fall Bracket	16	Internal Right Hand Stopend
8	90° Internal Angle	17	External Right Hand Stopend
9	120° Internal Angle		

Gutter Lengths

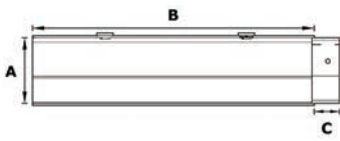

GUTTER SIZE A	B	C	DEPTH	PRODUCT CODE
125 (5")	1830	46	100	BI/MD54/6FT
150 (6")	1830	46	100	BI/MD64/6FT



90° External Angle

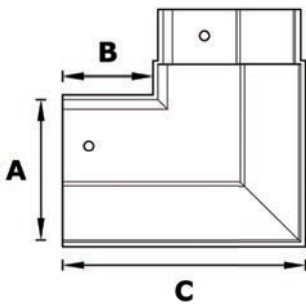

GUTTER SIZE A	B	C	PRODUCT CODE
125 (5")	76	28	BI/MD54/EA/90
150 (6")	76	25	BI/MD64/EA/90

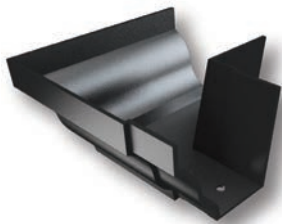

90° Internal Angle

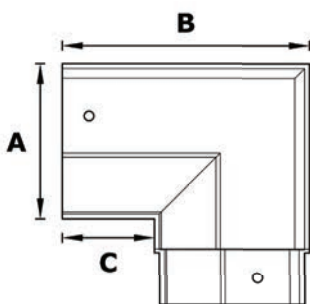

GUTTER SIZE A	B	C	PRODUCT CODE
125 (5")	212	164	BI/MD54/IA/90
150 (6")	210	160	BI/MD64/IA/90

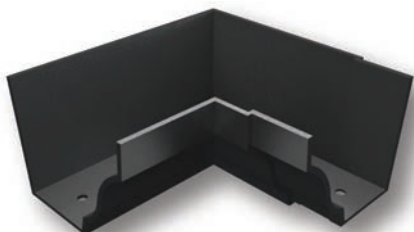

120° External Angle

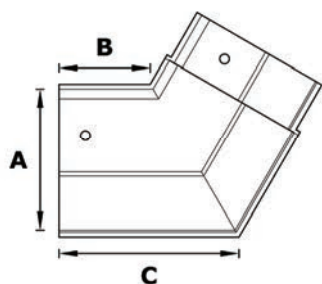

GUTTER SIZE A	B	C	PRODUCT CODE
125 (5")	28	76	BI/MD54/EA/120
150 (6")	25	76	BI/MD64/EA/120

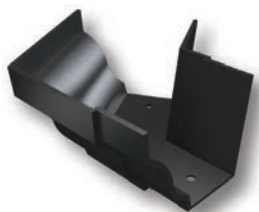

120° Internal Angle

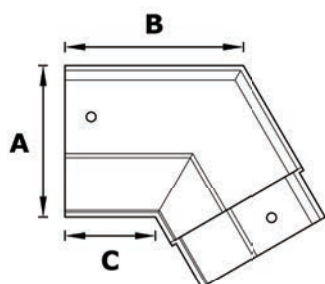

GUTTER SIZE A	B	C	PRODUCT CODE
125 (5")	154	106	BI/MD54/IA/120
150 (6")	155	105	BI/MD64/IA/120



135° External Angle

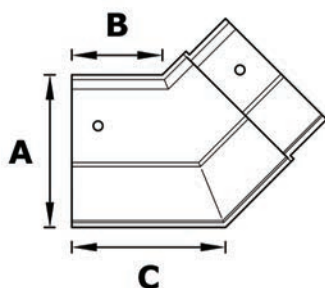

GUTTER SIZE A	B	C	PRODUCT CODE
125 (5")	28	76	BI/MD54/EA/135
150 (6")	25	76	BI/MD64/EA/135

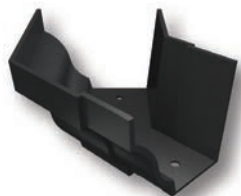

135° Internal Angle

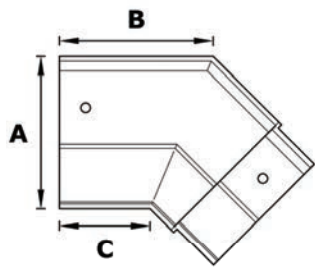

GUTTER SIZE A	B	C	PRODUCT CODE
125 (5")	132	84	BI/MD54/IA/120
150 (6")	132	85	BI/MD64/IA/120

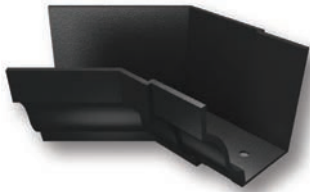

Running Outlet

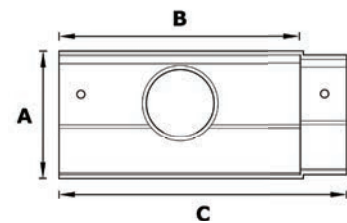

GUTTER SIZE A	OUTLET SIZE	B	C	PRODUCT CODE
125 (5")	Ø2.5"	246	292	BI/MD54/RO/25
125 (5")	Ø3"	246	292	BI/MD54/RO/30
125 (5")	Ø4"	246	292	BI/MD54/RO/40
125 (5")	4" x 3" Rect	246	292	BI/MD54/RO/43
150 (6")	Ø2.5"	250	296	BI/MD54/RO/25
150 (6")	Ø3"	250	296	BI/MD54/RO/30
150 (6")	Ø4"	250	296	BI/MD54/RO/40
150 (6")	4" x 3" Rect	250	296	BI/MD54/RO/43



Stopend - Right Hand External

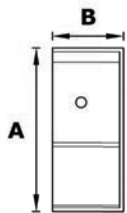

GUTTER SIZE A	B	PRODUCT CODE
125 (5")	50	BI/MD54/SE/RE
150 (6")	52	BI/MD64/SE/RE



Stopend Left/Right Hand Internal

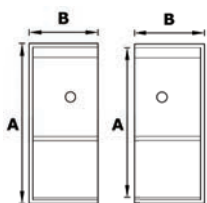

GUTTER SIZE A	B	PRODUCT CODE
125 (5")	50	BI/MD54/SE/RI
125 (5")	50	BI/MD54/SE/LI
150 (6")	52	BI/MD64/SE/RI
150 (6")	52	BI/MD64/SE/LI



Union Connector

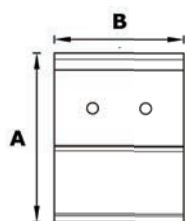

GUTTER SIZE A	B	PRODUCT CODE
125 (5")	100	BI/MD54/UC
150 (6")	100	BI/MD64/UC



Fascia Bracket

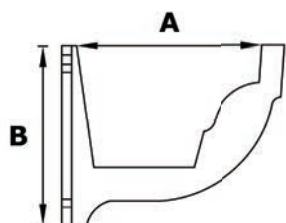

GUTTER SIZE A	B	PRODUCT CODE
125 (5")	146	BI/MD54/FB/CI
150 (6")	146	BI/MD64/FB/CI



Top Fix Rafter Bracket

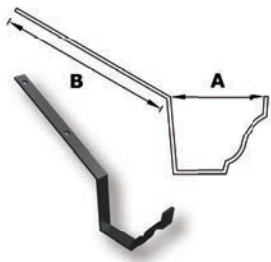

GUTTER SIZE A	B	PRODUCT CODE
125 (5")	250	BI/MD54/RB/TF
150 (6")	250	BI/MD64/RB/TF

Side Fix Rafter Bracket

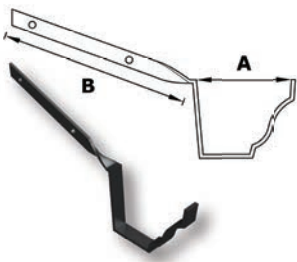

GUTTER SIZE A	B	PRODUCT CODE
125 (5")	200	BI/MD54/RB/SF
150 (6")	200	BI/MD64/RB/SF

Rise and Fall Bracket

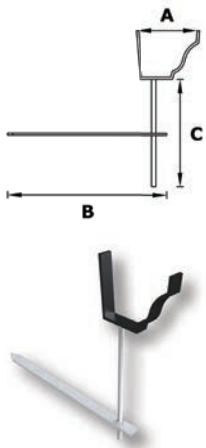

GUTTER SIZE A	B	C	PRODUCT CODE
125 (5")	300	140	BI/MD54/R&F/GS
150 (6")	300	140	BI/MD64/R&F/GS

Rise and Fall Bracket with Stay

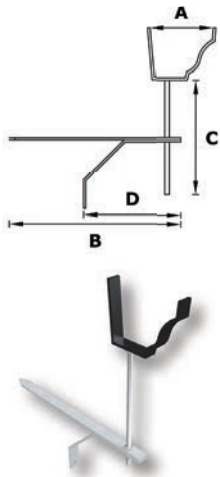

GUTTER SIZE A	B	C	D	PRODUCT CODE
125 (5")	300	140	220	BI/MD54/R&F/WS
150 (6")	300	140	220	BI/MD64/R&F/WS

— BRITANNIA —

Cast Iron Rainwater Pipes

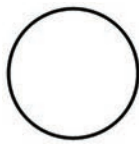

Circular



Rectangular

	2.5"	3"	4"	4" x 3"
Circular	✓	✓	✓	
Rectangular				✓

Cast Iron rainwater pipes are the traditional choice for durable and aesthetically pleasing systems. Ideal for replacing existing cast iron products on Heritage and Listed building projects.

- Traditional sand cast iron.
- Manufactured to BS 460:1964.
- Complies to all Listed building, Heritage and Conservation requirements.
- Supplied transit primed or factory applied wet paint finish in semi gloss black.
- Can be painted to a specific RAL/BS colour on request.
- Life expectancy - over 100 years.



System Overview



Number	Item	Number	Item
1	Pipe Length with Ears	10	Shoe without Ears
2	Pipe Length without Ears	11	Inspection Pipe with Ears
3	92.5° Bend	12	Inspection Pipe without Ears
4	112° Bend	13	1 Part Offsets
5	135° Bend	14	Loose Collar without Ears
6	92.5° Branch	15	Loose Collar with Ears
7	112° Branch	16	Earbelt Standard
8	135° Branch	17	Holderbat Standard
9	Shoe with Ears		

Pipe Lengths with Ears

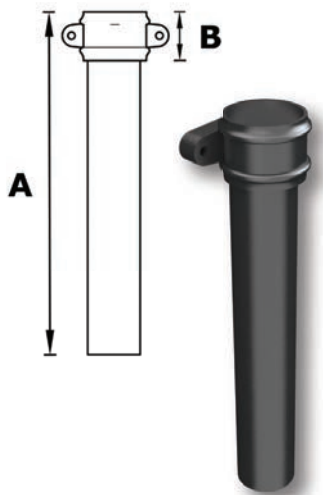

PIPE SIZE	A	B	PRODUCT CODE
63 (2½")	1830 (6')	75	BI/P25/6FT/E
76 (3")	1830 (6')	75	BI/P30/6FT/E
101 (4")	1830 (6')	75	BI/P40/6FT/E

Pipe Length no Ears

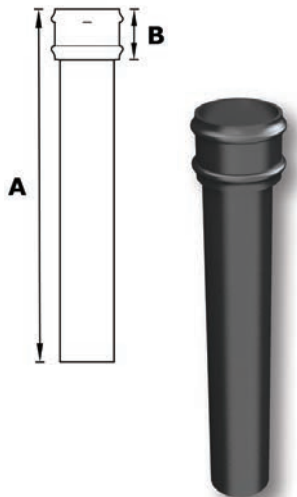

PIPE SIZE	A	B	PRODUCT CODE
63 (2½")	1830 (6')	75	BI/P25/6FT/NE
76 (3")	1830 (6')	75	BI/P30/6FT/NE
101 (4")	1830 (6')	75	BI/P40/6FT/NE

92.5° Bend

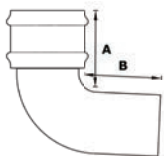

PIPE SIZE	A	B	PRODUCT CODE
63 (2½")	99	102	BI/P25/B/92
76 (3")	99	102	BI/P30/B/92
101 (4")	99	104	BI/P40/B/92



112° Bend

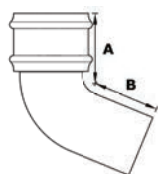

PIPE SIZE	A	B	PRODUCT CODE
63 (2½")	99	91	BI/P25/B/112
76 (3")	95	92	BI/P30/B/112
101 (4")	92	96	BI/P40/B/112



135° Bend

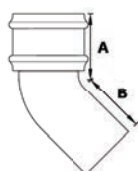

PIPE SIZE	A	B	PRODUCT CODE
63 (2½")	98	88	BI/P25/B/135
76 (3")	98	88	BI/P30/B/135
101 (4")	96	85	BI/P40/B/135



92.5° Branch

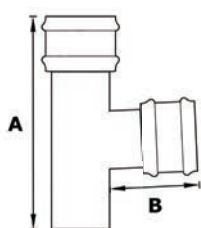

PIPE SIZE	A	B	PRODUCT CODE
63 (2½")	273	105	BI/P25/BR/92
76 (3")	292	105	BI/P30/BR/92
101 (4")	330	105	BI/P40/BR/92



112° Branch

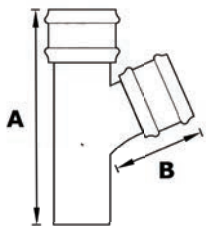

PIPE SIZE	A	B	PRODUCT CODE
63 (2½")	273	74	BI/P25/BR/112
76 (3")	292	74	BI/P30/BR/112
101 (4")	330	76	BI/P40/BR/112



135° Branch

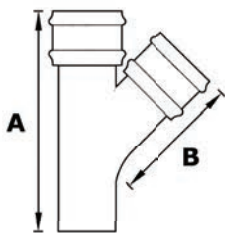

PIPE SIZE	A	B	PRODUCT CODE
63 (2½")	273	50	BI/P25/BR/135
76 (3")	292	50	BI/P30/BR/135
101 (4")	330	47	BI/P40/BR/135



Shoe with Ears

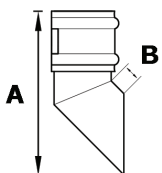

PIPE SIZE	A	B	PRODUCT CODE
63 (2½")	82	21	BI/P25/SH/E
76 (3")	88	13	BI/P30/SH/E
101 (4")	95	10	BI/P40/SH/E



Shoe without Ears

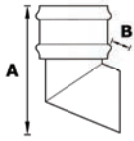

PIPE SIZE	A	B	PRODUCT CODE
63 (2½")	82	21	BI/P25/SH
76 (3")	88	13	BI/P30/SH
101 (4")	95	10	BI/P40/SH



Access Pipe with Ears

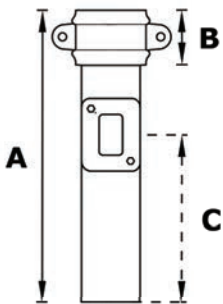

PIPE SIZE	A	B	C	PRODUCT CODE
63 (2½")	400	75	230	BI/P25/AP/E
76 (3")	400	75	230	BI/P30/AP/E
101 (4")	400	75	115	BI/P40/AP/E



Access Pipe without Ears

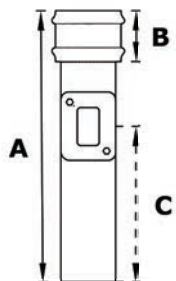

PIPE SIZE	A	B	C	PRODUCT CODE
63 (2½")	400	75	230	BI/P25/AP
76 (3")	400	75	230	BI/P30/AP
101 (4")	400	75	215	BI/P40/AP



Small Offset

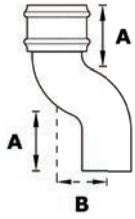

PIPE SIZE	A	B	PRODUCT CODE
63 (2½")	120	75 (3")	BI/P25/OS/03
63 (2½")	120	114 (4½")	BI/P25/OS/04
63 (2½")	120	150 (6")	BI/P25/OS/06
63 (2½")	120	224 (9")	BI/P25/OS/09
63 (2½")	120	300 (12")	BI/P25/OS/12
76 (3")	120	75 (3")	BI/P30/OS/03
76 (3")	120	114 (4½")	BI/P30/OS/04
76 (3")	120	150 (6")	BI/P30/OS/06
76 (3")	120	224 (9")	BI/P30/OS/09
76 (3")	120	300 (12")	BI/P30/OS/12
101 (4")	120	75 (3")	BI/P40/OS/03
101 (4")	120	114 (4½")	BI/P40/OS/04
101 (4")	120	150 (6")	BI/P40/OS/06
101 (4")	120	224 (9")	BI/P40/OS/09
101 (4")	120	300 (12")	BI/P40/OS/12

Large Offset

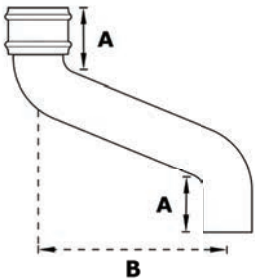

PIPE SIZE	A	B	PRODUCT CODE
63 (2½")	120	375 (15")	BI/P25/OS/15
63 (2½")	120	450 (18")	BI/P25/OS/18
63 (2½")	120	525 (21")	BI/P25/OS/21
63 (2½")	120	600 (24")	BI/P25/OS/24
63 (2½")	120	675 (27")	BI/P25/OS/27
63 (2½")	120	750 (30")	BI/P25/OS/30
76 (3")	120	375 (15")	BI/P30/OS/15
76 (3")	120	450 (18")	BI/P30/OS/18
76 (3")	120	525 (21")	BI/P30/OS/21
76 (3")	120	600 (24")	BI/P30/OS/24
76 (3")	120	675 (27")	BI/P30/OS/27
76 (3")	120	750 (30")	BI/P30/OS/30
101 (4")	120	375 (15")	BI/P40/OS/15
101 (4")	120	450 (18")	BI/P40/OS/18
101 (4")	120	525 (21")	BI/P40/OS/21
101 (4")	120	600 (24")	BI/P40/OS/24
101 (4")	120	675 (27")	BI/P40/OS/27
101 (4")	120	750 (30")	BI/P40/OS/30

Loose Collar with Ears



PIPE SIZE	A	PRODUCT CODE
63 (2½")	75	BI/P25/LS
76 (3")	75	BI/P30/LS
101 (4")	75	BI/P40/LS

Loose Collar without Ears

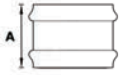

PIPE SIZE	A	PRODUCT CODE
63 (2½")	75	BI/P25/LS/E
76 (3")	75	BI/P30/LS/E
101 (4")	75	BI/P40/LS/E

Earbelt Standard

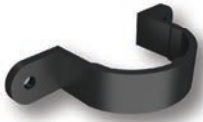
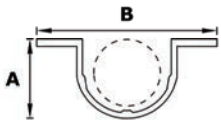

PIPE SIZE	A	B	PRODUCT CODE
63 (2½")	65	150	BI/P25/EB/ST
76 (3")	70	160	BI/P30/EB/ST
101 (4")	75	170	BI/P40/EB/ST

Holderbat Standard

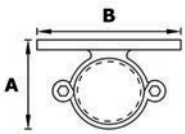

PIPE SIZE	A	B	PRODUCT CODE
63 (2½")	215	204	BI/P25/HB/ST
76 (3")	215	204	BI/P30/HB/ST
101 (4")	215	204	BI/P40/HB/ST

System Overview

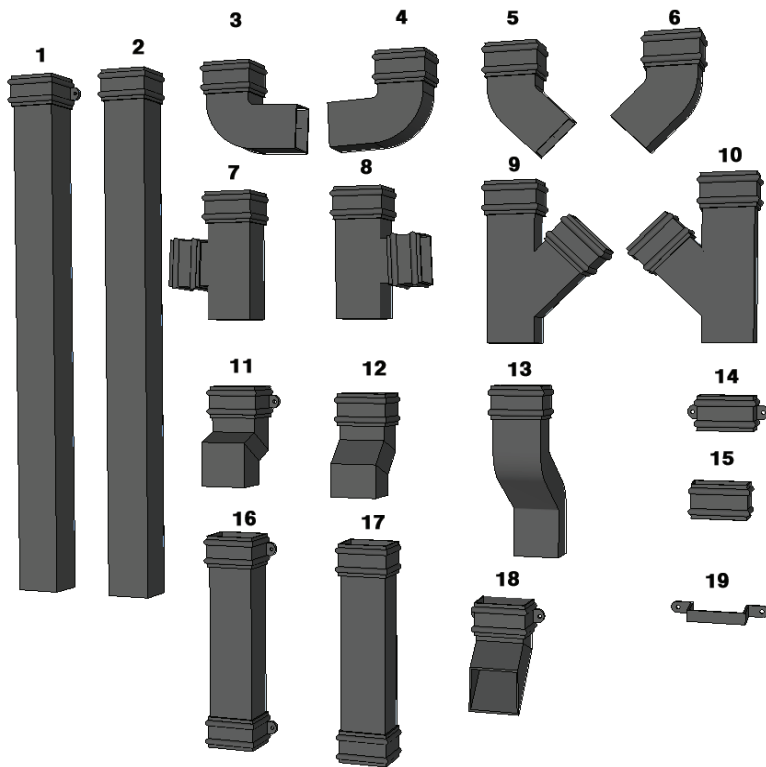

Number	Item	Number	Item
1	6ft Pipe Length with Ears	11	Eared 135° Offset
2	6ft Pipe Length without Ears	12	Non Eared 135° Offset
3	92.5° Right Hand Bend	13	1 Part 120° Offset
4	92.5° Left Hand Bend	14	Eared Collar Loose
5	135° Right Hand Bend	15	Non Eared Collar Loose
6	135° Left Hand Bend	16	3ft Pipe Length Double Eared Collars
7	92.5° Left Hand Branch	17	3ft Pipe Length Non Eared Collars
8	92.5° Right Hand Branch	18	Eared Shoe
9	135° Right Hand Branch	19	Earbelt Standard
10	135° Left Hand Branch		

Pipe Lengths with Ears

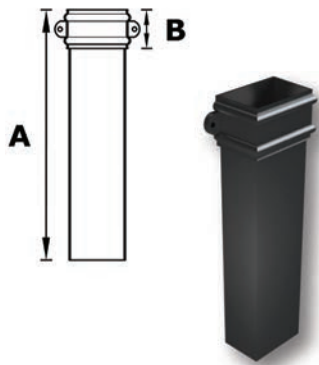

PIPE SIZE	A	B	PRODUCT CODE
100 x 75 (4" x 3")	1830 (6')	55	BI/P43/6FT/E
Double Collar Length			
100 x 75 (4" x 3")	915 (3')	55	BI/P43/DC/3FT/E

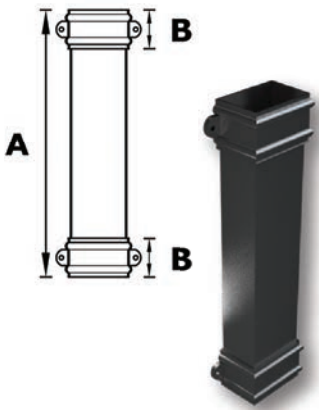

Pipe Length no Ears

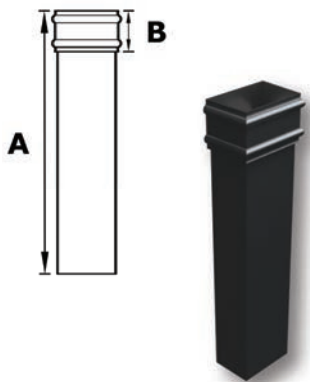

PIPE SIZE	A	B	PRODUCT CODE
100 x 75 (4" x 3")	1830 (6')	55	BI/P43/6FT/NE
Double Collar Length			
100 x 75 (4" x 3")	915 (3')	55	BI/P43/DC/3FT/NE

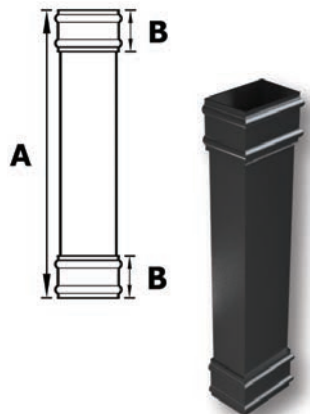

92.5° Right Hand Bend

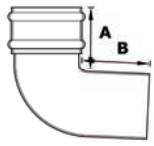

PIPE SIZE	A	B	PRODUCT CODE
100 x 75 (4" x 3")	75	90	BI/P43/B/92RH



92.5° Left Hand Bend

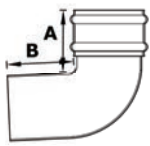

PIPE SIZE	A	B	PRODUCT CODE
100 x 75 (4" x 3")	75	90	BI/P43/B/92LH



135° Right Hand Bend

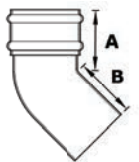

PIPE SIZE	A	B	PRODUCT CODE
100 x 75 (4" x 3")	75	90	BI/P43/B/135RH



135° Left Hand Bend

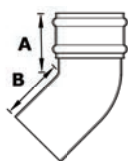

PIPE SIZE	A	B	PRODUCT CODE
100 x 75 (4" x 3")	75	90	BI/P43/B/135LH



92.5° Left Hand Branch

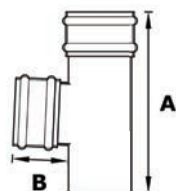

PIPE SIZE	A	B	PRODUCT CODE
100 x 75 (4" x 3")	300	90	BI/P43/BR/92LH



92.5° Right Hand Branch

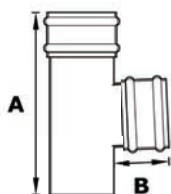

PIPE SIZE	A	B	PRODUCT CODE
100 x 75 (4" x 3")	300	90	BI/P43/BR/92RH



135° Left Hand Branch

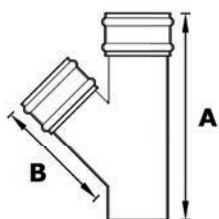

PIPE SIZE	A	B	PRODUCT CODE
100 x 75 (4" x 3")	300	90	BI/P43/BR/135LH



135° Right Hand Branch

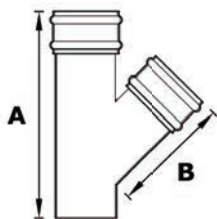

PIPE SIZE	A	B	PRODUCT CODE
100 x 75 (4" x 3")	300	90	BI/P43/BR/135RH



Eared 135° Plinth Offset

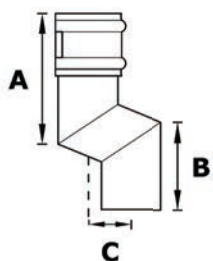

PIPE SIZE	A	B	C	PRODUCT CODE
100 x 75 (4" x 3")	120	63 (2½")	40	BI/P43/OS/02P/E
100 x 75 (4" x 3")	120	76 (3")	40	BI/P43/OS/03P/E



Non Eared 135° Plinth Offset

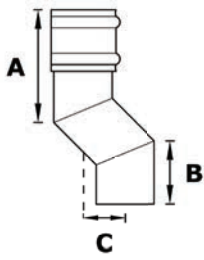

PIPE SIZE	A	B	C	PRODUCT CODE
100 x 75 (4" x 3")	120	63 (2½")	40	BI/P43/OS/02P
100 x 75 (4" x 3")	120	76 (3")	40	BI/P43/OS/03P



Eared Shoe

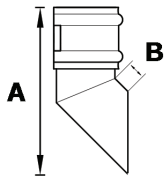

PIPE SIZE	A	B	PRODUCT CODE
100 x 75 (4" x 3")	75	15	BI/P43/BR/135LH



Need help with rainfall calculations?

We can help.

Simply provide us with a few dimensions and we will do the rest for you.

1 Part 120° Offset

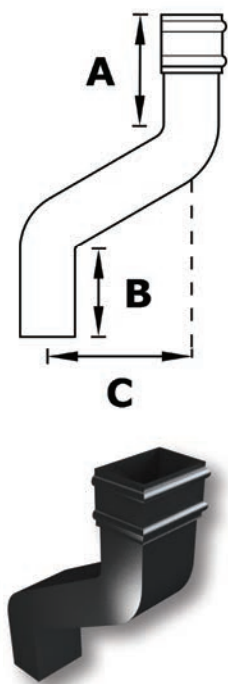

PIPE SIZE	A	B	C	PRODUCT CODE
100 x 75 (4" x 3")	300	150 (6")	40	BI/P43/OS/06
100 x 75 (4" x 3")	300	225 (9")	40	BI/P43/OS/09
100 x 75 (4" x 3")	300	300 (12")	40	BI/P43/OS/12

Earebelt Standard

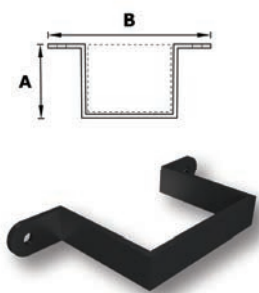

PIPE SIZE	A	PRODUCT CODE
100 x 75 (4" x 3")	120	BI/P43/BR/135RH



See our range of Colonnade Aluminium Downpipes and Hoppers to complement your aluminium gutters.

No 1 Flat Back

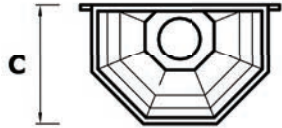
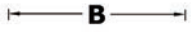
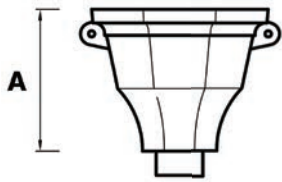

OUTLET SIZE	A	B	C	OUTLET	PRODUCT CODE
Ø63 (2½")	245	295	180	Circular	BI/RH/1/25F
Ø76 (3")	245	295	180	Circular	BI/RH/1/30F
Ø101 (4")	245	330	220	Circular	BI/RH/1/40F

No 1 Corner

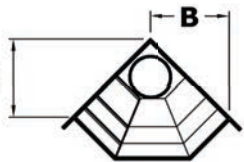
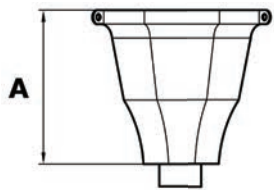

OUTLET SIZE	A	B	C	OUTLET	PRODUCT CODE
Ø63 (2½")	245	200	200	Circular	BI/RH/1/25C
Ø76 (3")	245	200	200	Circular	BI/RH/1/30C
Ø101 (4")	245	240	240	Circular	BI/RH/1/40C

No 2 Flat Back

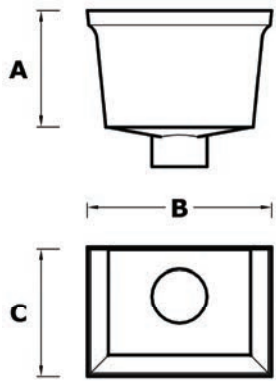

OUTLET SIZE	A	B	C	OUTLET	PRODUCT CODE
Ø63 (2½")	245	240	240	Circular	BI/RH/2/25
Ø76 (3")	245	240	240	Circular	BI/RH/2/30
Ø101 (4")	245	240	240	Circular	BI/RH/2/40
100 x 75 mm (4" x 3")	220	248	172	Rectangular	BI/RH/2/43



No 3 Flat Back

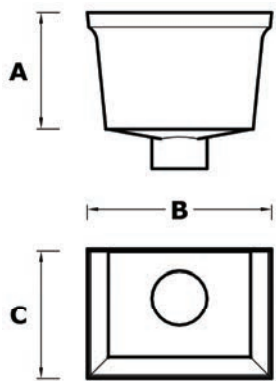

OUTLET SIZE	A	B	C	OUTLET	PRODUCT CODE
Ø63 (2½")	245	295	245	Circular	BI/RH/3/25
Ø76 (3")	245	295	245	Circular	BI/RH/3/30
Ø101 (4")	245	295	245	Circular	BI/RH/3/40
100 x 75 mm (4" x 3")	245	295	245	Rectangular	BI/RH/3/43



BEFORE YOU START

General Site Working

BS 8000 Workmanship on building sites, Parts 13 through to 16 with respect to above ground drainage and sanitaryware appliances are relevant in general terms.

Handling and Storage

Gutters, downpipes and fittings, particularly with painted finish should be handled with care and preferably stored under cover on racks to prevent scratching. Whilst it is not known to pose any health hazard, it is recommended that protective gloves be worn when handling cast iron material. All painted lengths are supplied in a protective polythene wrapping with components similarly wrapped and stored in cardboard boxes. If painted product is to be stored outside, cover with a tarpaulin to protect against rainfall and direct sunlight. Failure to do this may allow water to get trapped inside the protective wrapper and could lead to permanent watermarks on the paint finish. All primed products should have an additional primer coat, undercoat and top coat (in accordance with paint manufacturer's instructions) applied prior to being fitted.

Cutting and Drilling

Gutter sections may be cut on site using either an angle grinder or reciprocating saw fitted with appropriate meal diamond blade. Drilling should be done with diamond tipped drill bit. Where gutters or fittings are painted, then cut edges should be de-burred and then repainted with touch-up paint (available from ARP).

Setting Out

Cast Iron gutters must be installed a minimum fall of 1:600. When setting out for this fall it is imperative to identify the lowest and highest point. The lowest point needs to be the outlet, so mark this position first, followed by the highest point which will be the end of the run. A string line can then be used between these points to identify regular points of reference.

Materials Checklist

- Spirit level/straight edge
- Suitable screwdriver/attachment
- Sealant caulking gun
- Pencil or chalk
- String or laser line
- Hacksaw/electric jigsaw/chopsaw
- Tape measure
- Small wrench

Jointing

Any use of sealant must not be carried out in wet weather or in temperatures below 5°C or above 50°C. All Joint surfaces must be perfectly clean and dry. Only a low modulus sealant must be used to prevent early failure. Ensure that the gutter joint sockets/spigots are correctly aligned with each other to ensure free thermal movement (3-4mm) within the gutter joint.

Fixing

It is important that all fixings are suitable for both the substrate and the load. They must therefore be of the appropriate size and of a compatible material to ensure no electrolytic corrosion occurs. ARP recommends that stainless steel (preferably austenitic) screws must be used to fix gutters, whether direct, fascia or rafter bracket fixed.

Gutter Position

The current recommendations from the Metal Gutter Manufacturers Association (MGMA) is to position gutters as Fig 1.

Fig 1. As the line of the roof passes the gutter, a good proportion of debris sliding down the roof, such as leaves or snow will pass by without being collected. This position will also reduce potential snow build up back up the roof, which can put additional strain on brackets and fascia board adhesion.

There are certain conditions where a Fig 1 installation might allow water to over shoot the gutter in high wind conditions however this is deemed to be better than the above stated issues.

Fig 2. As the line of the roof sits inside the gutter profile, this encourages

debris, such as leaves or snow, to be collected and could cause an increase in debris clearing regularity and issues with bracket and fascia board adhesion strength in heavy snow conditions.



GUTTER FIXING

We advise that you ensure the fixing background (e.g. fascia board) is securely fixed, level and able to support the weight of the gutter at full capacity and that the roof overhang is correct (see gutter position).

Britannia cast iron gutters are fitted using fascia brackets. Buildings without fascias may need a different type of bracketry. ARP offers rise & fall brackets and rafter brackets as options, however due of the variety of installations these do not suit BS/EN levels regarding loading, so advice should be sought from ARP on parameters of use.

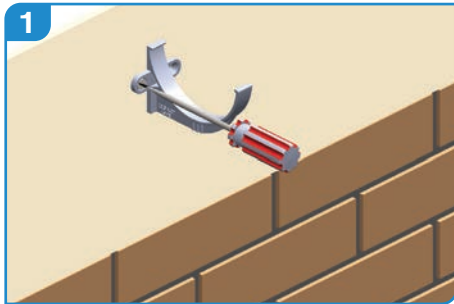

1 Identify the highest and lowest point of the gutter run and install brackets on each end ensuring a minimum fall of 1:600.

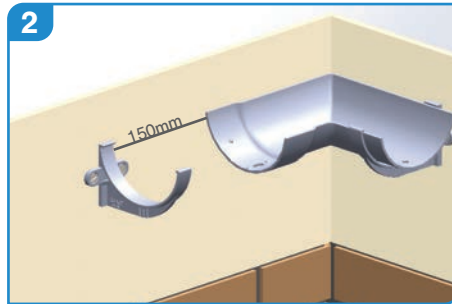

2 Image 2 shows the ideal bracket positioning for the angle and bracket to take the gutter length. (Max 150 mm from joint).

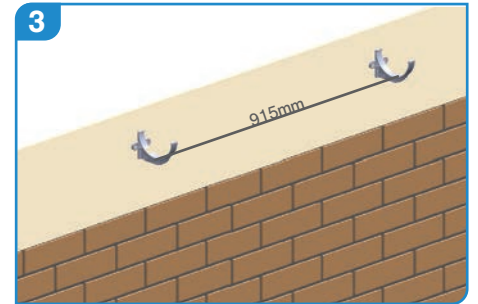

3 We recommend fixing brackets every 915mm and using an additional bracket for each outlet or angle.

Ideally using a string line or laser level between the two brackets, set out intermediate brackets at maximum centres of 915mm.



4 With the use of a plumb or laser line, position outlets over gullies and support with at least one bracket. Also include a bracket per angle (internal or external).

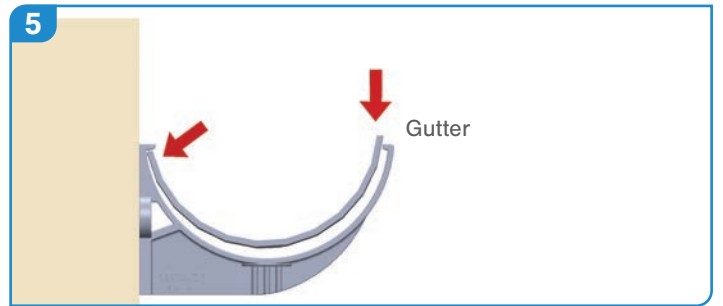

5 When fitting outlets and angles position the rear face of the gutter underneath the roof finish. Locate the gutter into the fascia bracket and then clip the front edge down into position.

After fitting outlets and angles, proceed with fitting the gutter lengths using the same method.



6 Ensure that all fixing surfaces are clean and dry. Apply 2 x 6mm beads of low modulus sealant into the socket end of gutter, place gutter length into sealant/socket.

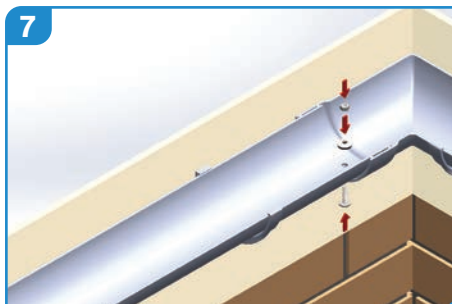

7 Push bolt through the sole of the gutter socket ensuring that the slot is filled with sealant before applying nut and washer, gently tighten. Do not overtighten as this may force the sealant out of the joint.

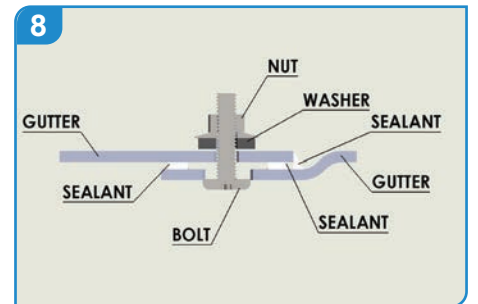

8 Clean off any excess sealant to either side of the joint. Apply additional sealant as required to the internal face only to create a smooth bead.

N.B. Union connectors are available to allow the use of cut lengths.



Any cut lengths should be de-burred and touched up with touch-up paint supplied prior to installation. For more information or further assistance, please contact us.

GUTTER FIXING

We advise that you ensure the fixing background (e.g. fascia board) is securely fixed, level and able to support the weight of the gutter at full capacity and that the roof overhang is correct (see gutter position).

Britannia cast iron gutters are fitted using fascia brackets. Buildings without fascias may need a different type of bracketry. ARP offers rise & fall brackets and rafter brackets as options, however due of the variety of installations these do not suit BS/EN levels regarding loading, so advice should be sought from ARP on parameters of use.

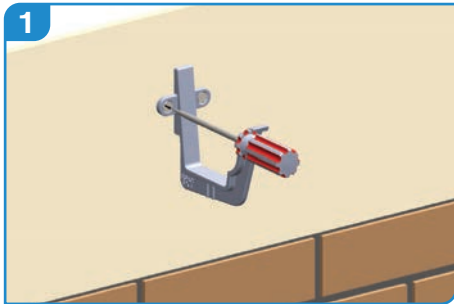

1 Identify the highest and lowest point of the gutter run and install brackets on each end ensuring a minimum fall of 1:600.

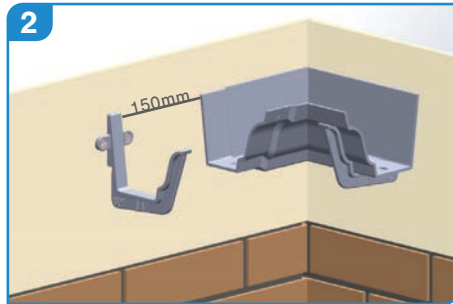

2 Image 2 shows the ideal bracket positioning for the angle and bracket to take the gutter length. (Max 150 mm from joint).

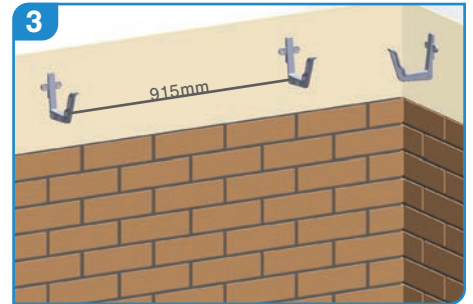

3 We recommend fixing brackets every 915mm and using an additional bracket for each outlet or angle.

Ideally using a string line or laser level between the two brackets, set out intermediate brackets at maximum centres of 915mm.



4 With the use of a plumb or laser line, position outlets over gullies and support with at least one bracket. Also include a bracket per angle (internal or external).

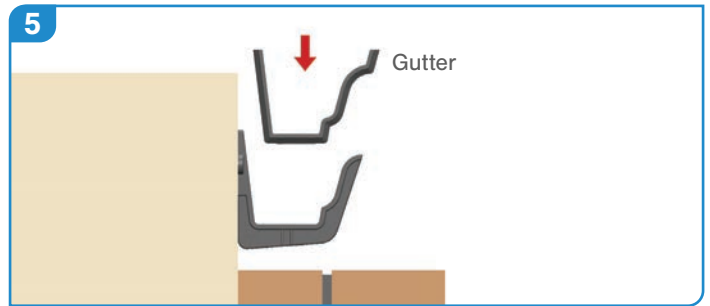

5 When fitting outlets and angles position the rear face of the gutter underneath the roof finish. Locate the gutter into the fascia bracket and then clip the front edge down into position.

After fitting outlets and angles, proceed with fitting the gutter lengths using the same method.

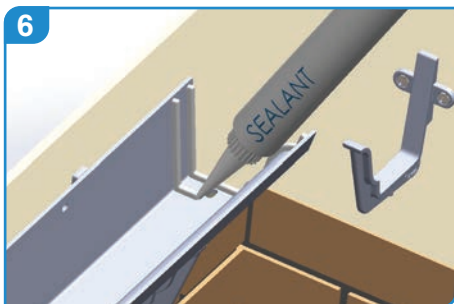

6 Ensure that all fixing surfaces are clean and dry. Apply 2 x 6mm beads of low modulus sealant into the plain end of the gutter, place the spigot end of the gutter length into sealant.

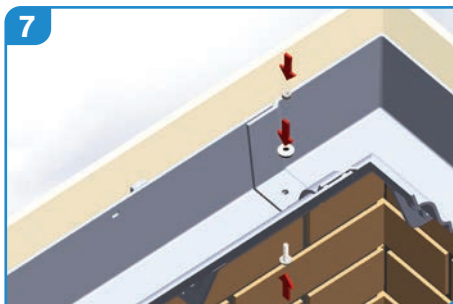

7 Push bolt through the sole of the plain end of the gutter from the underside and position spigot end of gutter directly over joint. Ensure that the slot is filled with sealant before applying nut and washer, gently tighten. **Do not overtighten as this may force the sealant out of the joint.**

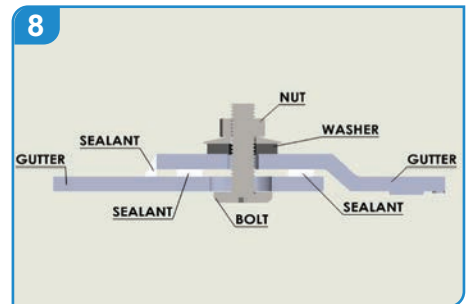

8 Clean off any excess sealant to either side of the joint. Apply additional sealant as required to the internal face only to create a smooth bead.

N.B. Union connectors are available to allow the use of cut lengths.



Any cut lengths should be de-burred and touched up with touch-up paint supplied prior to installation. For more information or further assistance, please contact us.

DOWNPIPE FIXING

We advise that you ensure the fixing background is in good condition and will support the downpipe and that there are sufficient clips/brackets in place to secure the load.

When fitting Britannia cast iron downpipes, start from the outlet and work towards the gully. Make sure you have the right combination of offsets/bends/branches and pipe to complete the installation.

Maximum fixing centres is 2 metres – using correct stainless-steel fixings and plugs for the substrate being fitted to.

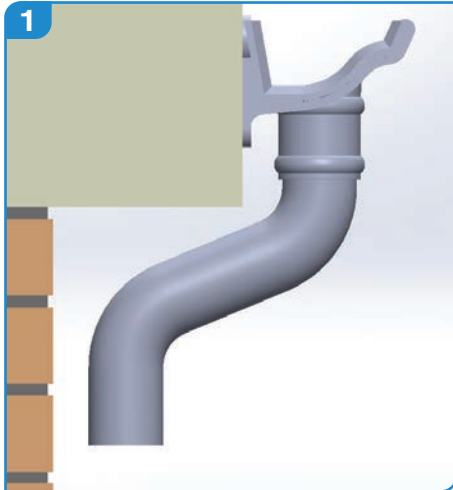

Ensure vertical alignment between drain and gutter outlet.

Adjust the offset to suit the projection. Place the offset in position from the outlet and fix the first pipe into place, thus holding the offset in position.

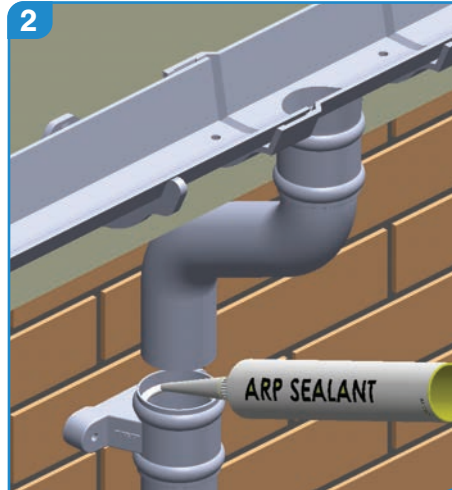

Sealant can be applied to the inside of the pipe socket prior to installation. When fitting flushjoint downpipe, sealant can also be applied to the inside of the clip to assist in supporting the pipe.

A pipe clip should be fixed directly beneath the pipe socket.

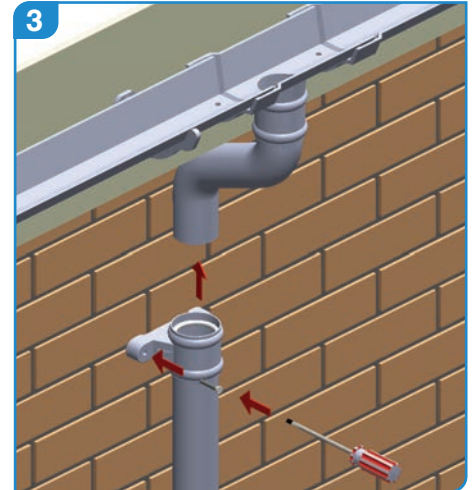

Additional pipe clips should be fitted at 2m maximum intervals.

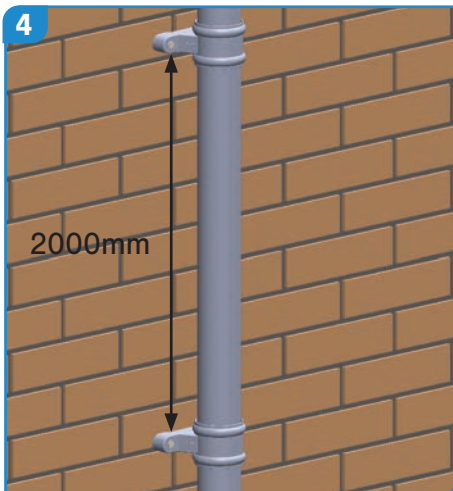

Carry on installing pipes in this fashion until reaching the drain. Clips to be fixed with plastic wall plugs and stainless steel screws of a size suitable for the substrate.



A shoe, drain adaptor or offset may be required to terminate the pipe work into the gully



As per local building regulations, if a shoe is not installed access pipes should be fitted and positioned to give suitable rodding access as required.

ACCESS FURTHER DOCUMENTS AND ARP'S LITERATURE

Visit arp-ltd.com/services/download-centre

ARP
Metal Rainwater and Roofline Products

Images showing various gutter and roofline installations on different building styles.

Logos: RHA, MGA, BBA

ARP
Metal Roofline and Rainwater Products

The sustainable and eco-friendly alternative to plastic.

Images showing a close-up of a gutter installation on a roof.

LEGACY	SENTINEL	LEGION	COLONNADE	TRUELINE	BRITANNIA
Cast Aluminium Gutters	Extruded Aluminium Gutters	Pressed Aluminium Gutters	Aluminium Rainwater Pipes	Fascia, Soffits, Copings, Cappings and Bespoke Pressings	Cast Iron Gutters and Downpipes
Examples of profiles available	Examples of profiles available	Examples of profiles available	Examples of profiles available	Examples of profiles available	Examples of profiles available
Product Comparison Table	Product Comparison Table	Product Comparison Table	Product Comparison Table	Product Comparison Table	Product Comparison Table

E: sales@arp-ltd.com | www.arp-ltd.com

ARP
Sectional Price List April 2020

Images showing various gutter and roofline products.

ALUMINIUM & CAST IRON RAINWATER & ROOFLINE PRODUCTS

COLONNADE Square/Rectangular Swaged Pipes

Pipe Size (A x B)	Maximum Length	Product Code
50 x 50mm	0.5, 1.0, 1.5, 2.0, 2.5, 3.0m	AD50
75 x 75mm	0.5, 1.0, 1.5, 2.0, 2.5, 3.0m	AD75
100 x 100mm	0.5, 1.0, 1.5, 2.0, 2.5, 3.0m	AD100
150 x 150mm	0.5, 1.0, 1.5, 2.0, 2.5, 3.0m	AD150

ARP Ltd. 0116 289 4400 | www.arp-ltd.com

MUSTANG Seamless 5" Gutter

Product Description: Mustang Seamless aluminium gutters are the perfect alternative to UPVC. Backed by a BBA certificate, this superior system provides 30+ years of maintenance free use.

Properties: Formed from 6061-T6 aluminium alloy - alloy 3102B HAS tested under BBA certificate no. 912825. Other sizes available. Coated with an Aluminium Resistant System (ARS) in a range of colours including: Black, White, Brown, Light and Dark Grey.

Installation: The main advantage of seamless gutters is that they do not have any joints, so the material is produced in lengths on site. When a corner or else end is required, leak free interlocking components are combined with the long lengths to create an endless length of up to 30 metres.

Functional Life Expectancy: When installed by an ARP Approved Installer, the BBA certificate states that the product will not require any maintenance for 30 years and has a life expectancy in excess of this period. Further information is available from the ARP website or BBA certificate no. 912825.

ARP Ltd. 0116 289 4400 | www.arp-ltd.com

TECHNICAL PRODUCT GUIDES

ARP SENTINEL
Technical Product Guide 2021

Images showing Sentinel gutter products.

ARP LEGACY
Technical Product Guide 2021

Images showing Legacy gutter products.

ARP BRITANNIA
Technical Product Guide 2021

Images showing Britannia gutter products.

ARP LEGION
Technical Product Guide 2021

Images showing Legion gutter products.

ARP COLONNADE
Technical Product Guide 2021

Images showing Colonnade gutter products.