



TechBook

in.touch 2

ultimate Wi-Fi remote control for your spa



Simplest of setups

Strong and long range communication signal

State-of-the-art apps with push notifications





Table of contents

Warning	2
Introduction	3
Overview	
- in.touch 2 overview	4
- in.touch 2 dimensions	4
Installation and connections	
- in.touch 2-CO (spa) installation	5
- Connection of the in.touch 2-CO (spa)	6
- in.touch 2-EN (home) installation	7
- Connection of the in.touch 2-EN (home)	7
Start up	
- Pairing in.touch 2-CO (spa) and in.touch 2-EN (home)	8
LED Status	9
Application	10
- Download application	10
- Using the app	10
- Setup your Wi-Fi on your iOS devices	11
- Start the in.touch 2 application	12
- Select a spa	13
- Home page	13
- Spa state	14
- Water Care	15
- Modifying schedules	16
- Settings	17
- Wi-Fi	17
- in.touch network	18
- Change channel	18
- Tips	19
- About	19
- Name	20
Troubleshooting	21
- in.touch 2-EN (home) status LED	21
- in.touch 2-CO (spa) status LED	22
Specifications	23



Warning



WARNING:

Before installing or connecting the unit, please read the following.

- * FOR OPTIMUM PERFORMANCE PLEASE CAREFULLY READ THE MANUAL BEFORE INSTALLATION.
- * INSTALL THE IN.TOUCH 2-CO MODULE AT LEAST 12" (30 CM) AWAY FROM ANY METAL PART OR ANY METAL FOIL.
- * THE IN.TOUCH 2-CO MODULE SHOULD BE INSTALLED SUCH AS IT CAN BE RELOCATED UNDER THE SPA IN ORDER TO OBTAIN OPTIMAL RECEPTION AFTER FINAL INSTALLATION OF THE SPA IN THE YARD.
- * TO SATISFY FCC RF EXPOSURE REQUIREMENTS FOR MOBILE AND BASE STATION TRANSMISSION DEVICES, A SEPARATION DISTANCE OF 8" (20 CM) OR MORE SHOULD BE MAINTAINED BETWEEN THE IN.TOUCH 2 MODULES AND PERSONS DURING OPERATION; TO ENSURE COMPLIANCE, OPERATION AT CLOSER THAN THIS DISTANCE IS NOT RECOMMENDED.
- * THE ANTENNAS USED FOR THESE MODULES MUST NOT BE CO-LOCATED OR OPERATING IN CONJUNCTION WITH ANY OTHER ANTENNA OR TRANSMITTER.

DISPOSAL OF THE PRODUCT

THE APPLIANCE (OR THE PRODUCT) MUST BE DISPOSED OF SEPARATELY IN ACCORDANCE WITH THE LOCAL WASTE DISPOSAL LEGISLATION IN FORCE.



COMPATIBILITY REQUIREMENTS

in.touch 2 modules for FCC (North America) models (915 MHz):

Home and spa transmitter kit: 0608-521020

in.touch 2 modules for ETSI (Europe) models (868 MHz):

Home and spa transmitter kit: 0608-521021

Compatible spa packs:

in.xm2, in.xe, in.ye, in.yj and in.yt spa systems manufactured in or after 2012.

in.touch 2 application:



Compatible with devices running:
iOS 8.0 or higher

ROUTER AND INSTALLATION REQUIREMENTS

Any standard router with an available 100 Mbps (wired LAN) RJ45 port can be used. The router must also have its Port 10022 open, which is normally a default setting. A 3-foot (0.9 m) Ethernet cable is included.

The home transmitter will need a main supply (120V in North America, 220V in Europe) nearby to allow connection of the transformer.

Aeware®, Gecko®, and their respective logos are Registered Trademarks of Gecko Alliance Group.
in.touch 2™, in.xm2™, in.xe™, in.yt™, in.ye™, in.therm™ and their respective logos are Trademarks of Gecko Alliance Group.

All other product or company names that may be mentioned in this publication are tradenames, trademarks or Registered Trademarks of their respective owners.



in.touch 2

Easily integrate your spa to the Internet of Things!

Simplest of setups

in.touch 2 eliminates all the complexities of connecting your spa to the Internet and transforms your smartphone or tablet into your ultimate Wi-Fi spa remote control. in.touch 2 comes with state-of-the-art apps and 2 pre-paired radio frequency transmitters, one being part of your spa system and the second one being connected to your Internet router. Both RF transmitters are pre-linked to one another, enabling an immediate and perfect communication between you and your spa.

Strong and long range communication signal

Through their proprietary RF technology, in.touch 2 transceivers emit a strong, stable and long range signal between your spa and your router (about 3 times longer than regular Wi-Fi signal). No need for repeaters or boosters: your spa will always remain within reach in typical backyard settings.

State-of-the-art app with push notifications

in.touch 2 streamlined application makes it very easy to control and program all the functions and features of your spa from your smartphone or your tablet. Even when you're away from home, you get full control of your water care settings, filtration cycles, water temperature, economy modes and a lot more. Push notifications will always keep you informed on the status of your spa, even when your app is not open.



Overview

in.touch 2 overview

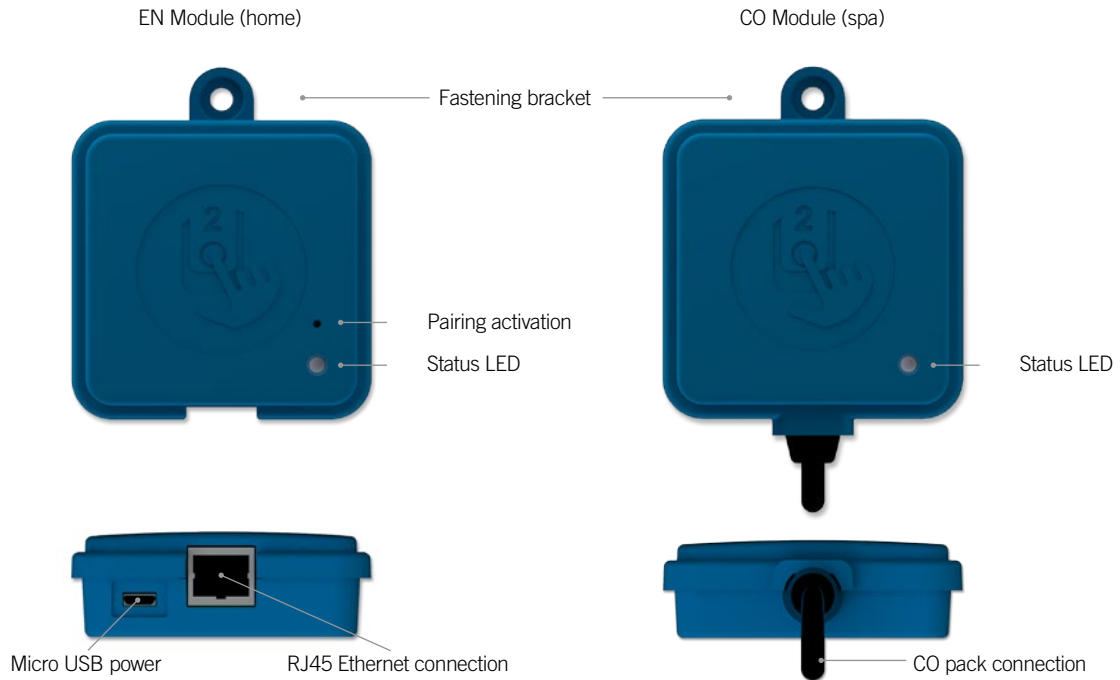

in.touch 2 dimensions

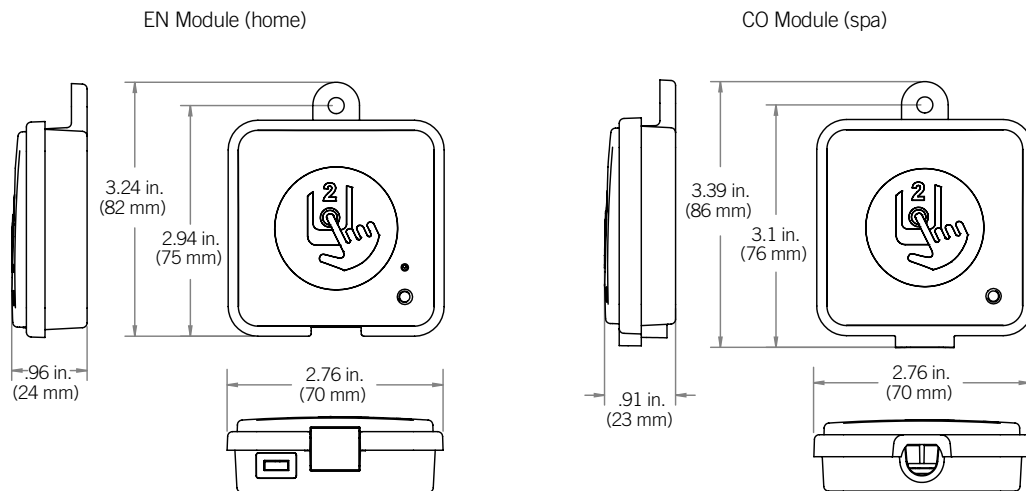



Installation and connections

in.touch 2-CO (spa) installation

Before proceeding with any installation, be sure to turn spa power off.

The in.touch 2-CO unit must be installed under the spa skirt, at least 12" (30 cm) away from any metal component or structure. This is necessary to ensure optimal transmission. In some cases, it may be necessary to relocate the unit once the spa is installed in the yard to ensure proper signal transmission and distance.

Install the in.touch 2-CO so the module can be repositioned to optimize the signal strength in the yard (it is possible to see the signal strength with the in.touch 2 application in the menu Setting -> in.touch network -> Signal strength). We recommend that you install the unit with a #8 pan head screw.

Here are some suggestions for a successful installation:

- Install the unit as high as possible within the spa skirt, but keep it away from the spa frame if it is metallic.
- Route the cable and leave some slack in the in.touch 2-CO cable so the in.touch 2-CO can be moved around in case of reception problems.
- Install the in.touch 2-CO in a corner of the spa to help avoid metallic components, accessories and piping close to the in.touch 2-CO.
- The in.touch 2-CO module should be installed as close as possible to the house to optimize signal strength. It is recommended to install the in.touch 2 module on the side of the spa facing the house to increase the signal. A body of water between the in.touch 2-CO module and the in.touch 2-EN will reduce the signal strength.

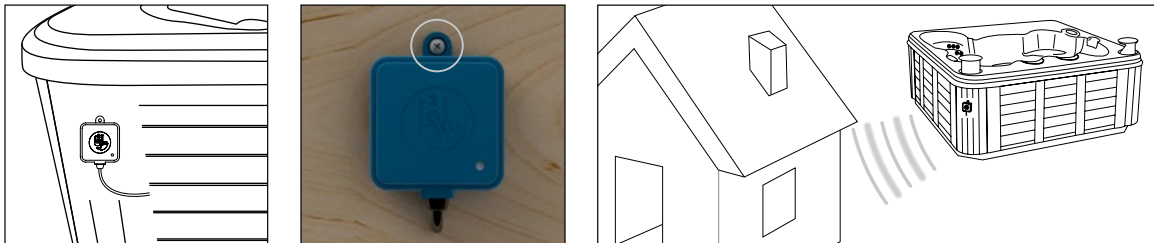



Installation and connections

Connection of the in.touch 2-CO (spa)

Simply connect the in.touch 2-CO module into an available CO port of the spa pack (or any other accessory with a free CO port, such as the in.stream 2 audio amplifier, or the in.clear spa sanitizing system).

Note that the in.touch 2-CO only has a single CO cable and thus must be installed at the end of the CO chain if more than a single accessory is installed on the same CO port of the spa pack.

Note: Before powering up the spa pack again, please go to the next step and install the in.touch2-EN module.

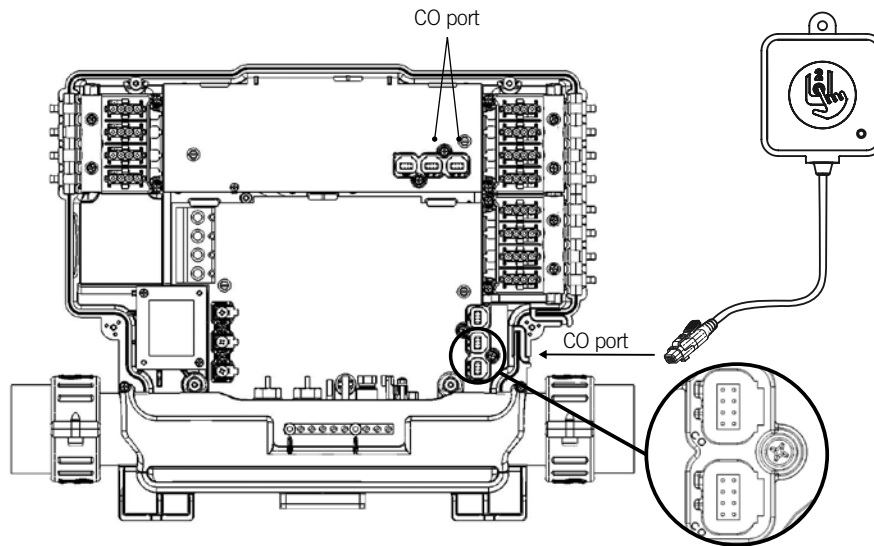

Installation and connections

in.touch 2-EN (home) installation

The in.touch 2-EN unit must be installed inside the house near the router as it needs to be connected to it. The in.touch 2-EN is provided with an Ethernet cable and a power supply. If required, a longer cable of good quality can be used by the installer (longer cable not provided) to install the in.touch 2-EN module closer to the spa within the home. The only requirement for installation location is that household current be available to power the in.touch 2-EN module using the provided wall transformer.

The in.touch 2-EN can be fixed in the house to optimize the signal strength. We recommend that you install the unit with a #8 pan head screw.

Here are some suggestions for a successful installation:

- If possible, install device on the first floor of your house.
- If installing in a basement, place at highest level possible and closest to a window.
- Try to install as far as possible from materials that may interfere with signal (ie. metal structures, thick cement walls).

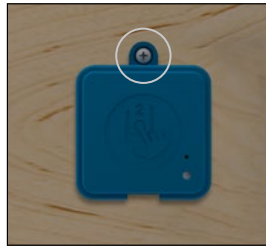
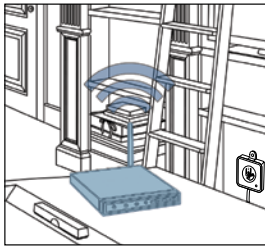

Connection of the in.touch 2-EN (home)

Simply connect Ethernet cable into the RJ45 port of the in.touch 2-EN module and in one of the available LAN ports on the router.

Finally, to power up the in.touch 2-EN, connect the provided transformer to a 120V (North American model) or 220V (European model) household supply and connect the USB cable between the transformer and the in.touch 2-EN.

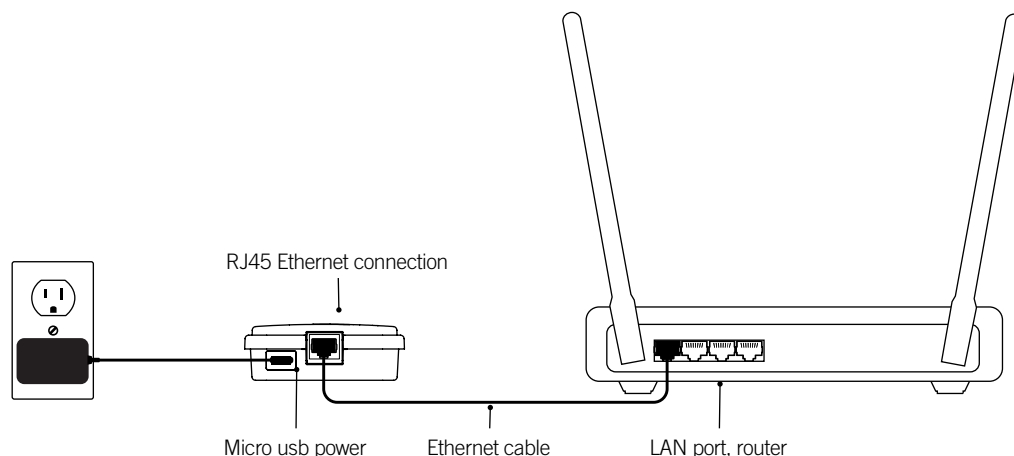



Start up

Pairing in.touch 2-CO (spa) and in.touch 2-EN (home)

The pairing process is used when you need to replace one module of the in.touch 2 kit. Otherwise, the in.touch 2 arrives pre-paired from the factory.

1. Power up the in.touch 2-EN module

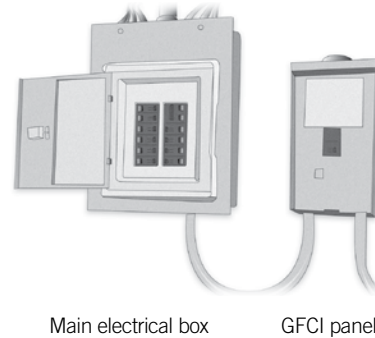
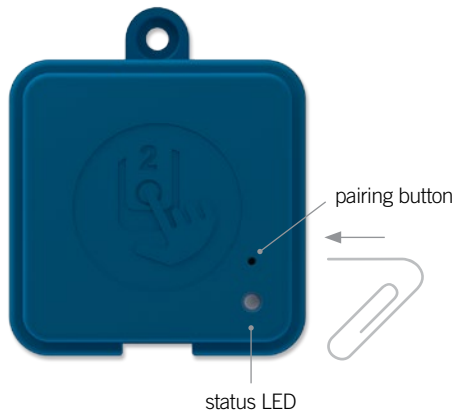

2. Press on the pairing button with a paper clip or some similar tool. When the pairing mode is active the status LED flashes YELLOW in a rapid pattern. The in.touch 2-EN is then in pairing mode and will remain in this mode until it pairs with an in.touch 2-CO module, or until it is reset (power cycled).
3. Shut off the spa's breaker (thus turning off the in.touch 2-CO module), wait a few seconds, and then flip the breaker back on. Within a few seconds, the pairing operation should complete and the in.touch 2-EN status LED will no longer be YELLOW.

Note: in.touch 2 modules can be paired as often as necessary, but can only be paired with a single counterpart module at a time. Once paired, the modules store this information permanently until the next pairing operation. Pairing information is stored in non-volatile memory, so pairing is not required after a power failure. Only an in.touch 2-EN module can initiate a pairing, so it is important that the pairing begin with putting the in.touch 2-EN module in pairing mode.

If several spas are powered up at the same time with an in.touch 2-EN module in pairing mode (for instance, in a dealer showroom), only the 1st spa to successfully connect to the in.touch 2-EN will pair. As this can be random, it is recommended that only 1 spa be powered up at a time during the pairing process.



LED Status

LED

Each in.touch 2 module has a status LED that can be used for troubleshooting purposes. The LED is located on the top of both enclosures.

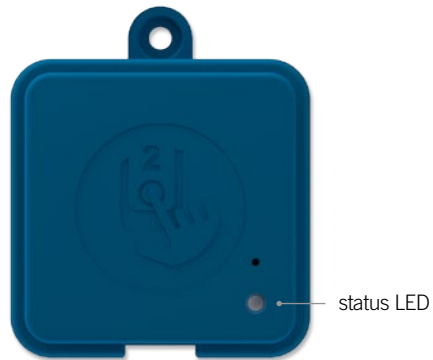

EN Module (home)

Pairing mode	Yellow (Blinking)
Router not detected	Red
Router detected	Green
in.touch 2 server detected	Blue
Module is fully functional	

CO Module (spa)

Pairing mode	Yellow (Blinking)
Spa controller not detected	Red
in.touch 2 server detected	Blue
Module is fully functional	

* When the LED status is blinking (blue, green or red) this indicates that the communication between the EN module and the CO module is not established.



Application

Download application



The in.touch app allows you to control your spa using your home network or an Internet connection anywhere in the world. The in.touch 2 app is waiting for you in the App Store for iOS devices— search for «in.touch 2» then click on it to install.

Using the app

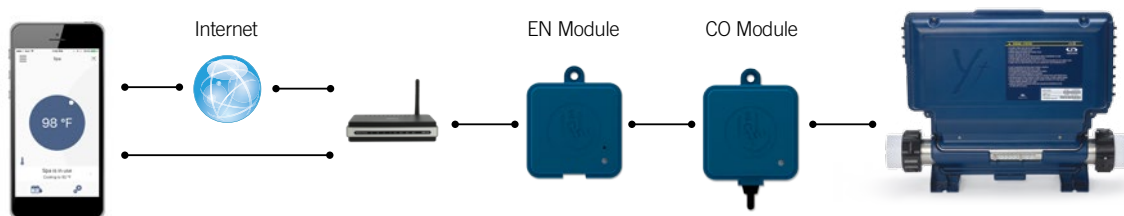

On your home network

It is possible to access your spa with the in.touch 2 app through your home network. To be able to see your in.touch 2 in the application you need to connect your device to the same router (WiFi network) than the one used to connect your in.touch 2-EN module.

Go to the WiFi settings section of your mobile device and choose the same network that your spa is connected to (i.e. Home). Once you've selected it, wait until your device confirms the connection.

On the Internet

The in.touch 2 allows you to use the Internet to control your spa from anywhere in the world. In order for them to communicate, both the in.touch 2 module and your device must be connected to a network that allows access to the Internet.

Once your in.touch 2-EN module is connected to the Internet (the LED status is blue), you can use your in.touch 2 app any time your device is also connected to the Internet (wireless or cellular network), even if you are away from home. To have access to your spa away from home, you will need to have previously linked your mobile device to your spa on your home network.



Application

Setup your Wi-Fi on your iOS devices

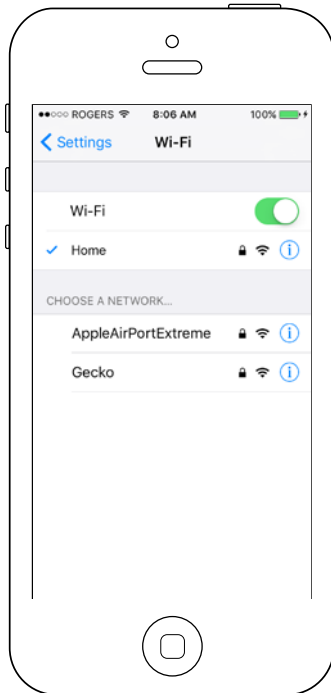

Before using your application, go to the WiFi section of your device's settings. Make sure you are connected to your home network. This needs to be the same WiFi provided by the router to which you connected your in.touch 2-EN module.



Application

Start the in.touch 2 application

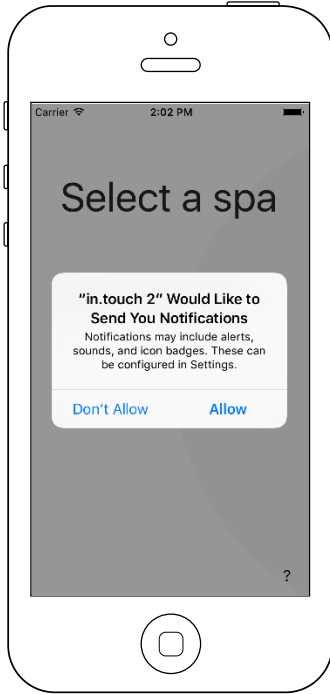

Find the icon for the in.touch 2 application, then tap on it to open it.

The first time you use the application a message will ask you: “in.touch 2” Would like to send you notifications. If you choose *Allow*, the application will send you notifications about the status of your spa. If you choose *Don't Allow*, the application will not send you notifications.

If you change your mind later concerning notifications, you may add or remove notifications for the in.touch 2 application. Go in your settings menu in your iOS device and choose in.touch 2. Select the notifications menu, you can turn notifications on or off from this page.

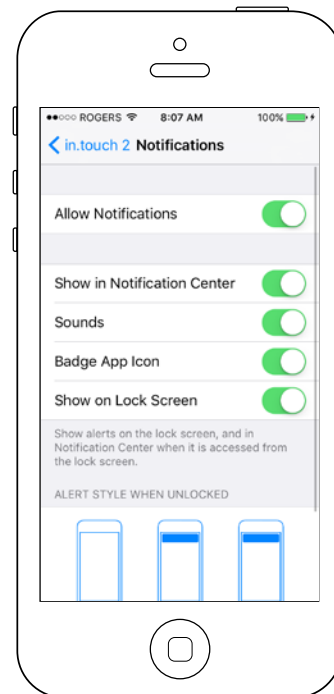
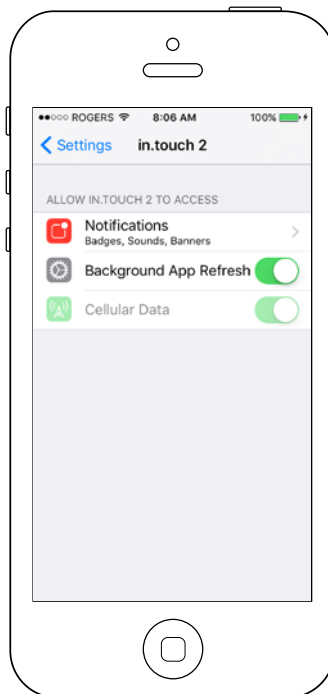
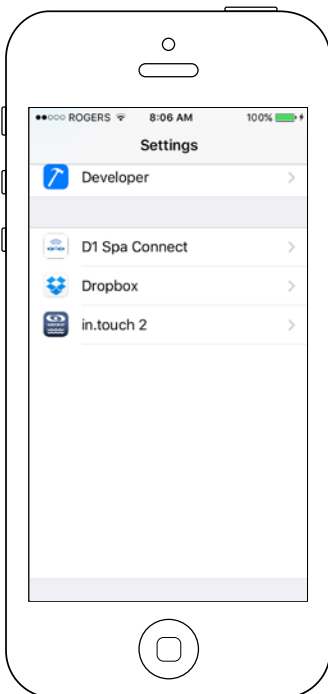

Application

Select a spa

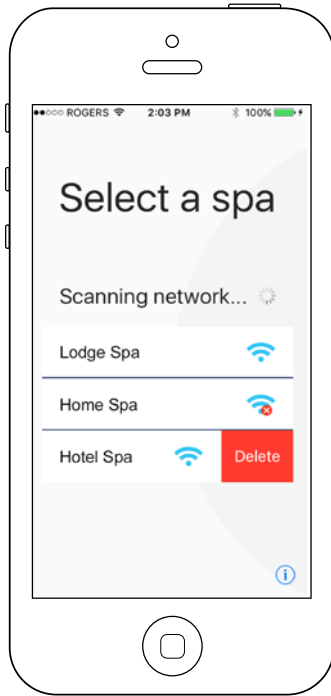

This page displays all the spas detected by your application. To detect your spa, you need to connect your mobile device to the same network to which you connected your in.touch 2-EN module.

Once you have done a connection with the spa its name will be saved on this page to allow you to connect to this spa from anywhere.



- Indicates that the in.touch 2 is available for connection.



- A red cross indicates that the in.touch 2 module is not detected.

To delete a spa from this list, slide the spa name to the left and tap on *Delete*.

Note: If you are currently connected on the same local network as your spa and try to delete it, this one will reappear as soon as the menu refreshes.

Home page

The main screen gives you access to your accessories, water temperature, water care and settings.

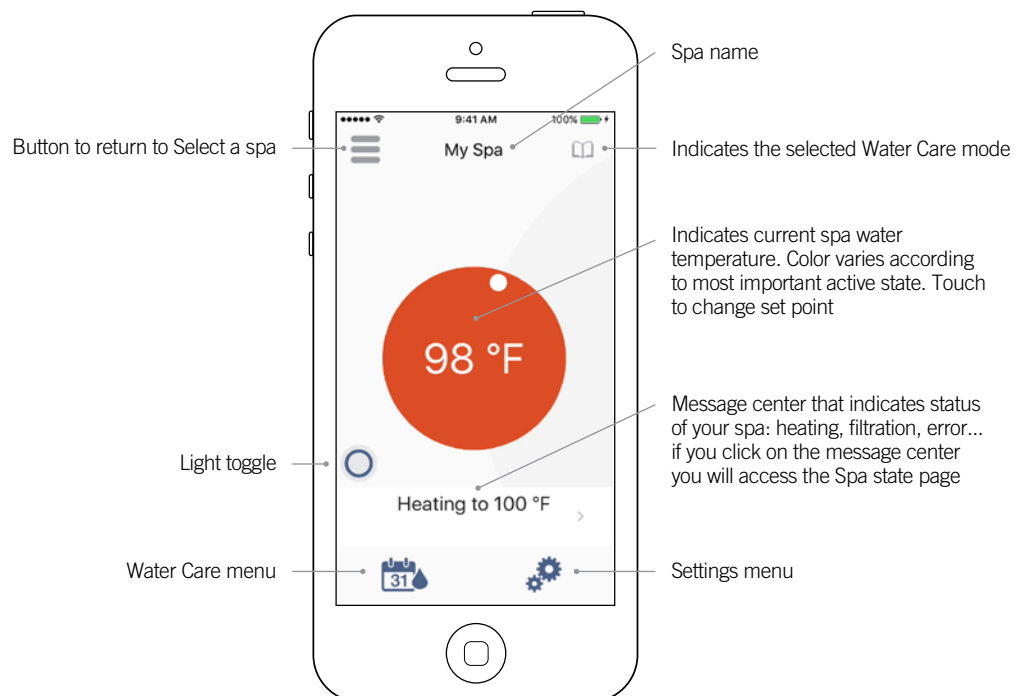







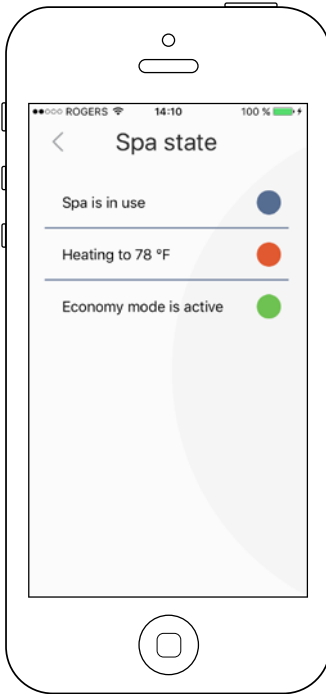

Application

Spa state



This page displays all the active states of your spa. Below is a quick description of each state you may encounter on your spa. Each state is associated to a priority and color that determines the color of the circle on the home page.

-  Indicates that there is an error on your spa.
-  Indicates that there is presently an active user demand on your spa (ie. pump, blower or light is on).
-  Indicates that your spa is now heating to your set point.
-  Indicates that your spa is now in a filtering cycle.
-  Indicates that your spa is now in economy mode.
-  Indicates that your spa is running normally (there is no user demand, heating, no filtration or economy active).

The circle on the home page displays a single color at a time. The color displayed is decided by priority of state. The established priority is as listed above.

Application

Water Care

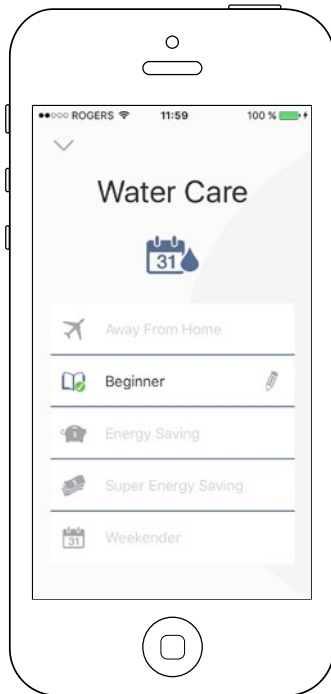

The Water Care page will help you set up your ideal filtration and heating settings. Choose between *Away from Home*, *Beginner*, *Energy Savings*, *Super Energy* and *Weekender*, depending on your need. Touch the Water Care name you would like to activate, a green checkmark will appear on the icon, indicating you have selected it.

By default, each Water Care mode has pre-configured schedules of economy and filtration. To modify Water Care options, touch the pencil icon at the right end of the desired Water Care to open its menu.

Below you have a short description of each Water Care at default state:



Away From Home:

In this mode the spa will always be in economy; the set point will be reduced by 20° F.



Beginner / Standard:

The spa will never be in economy mode and will be filtering according to the pack's low level configuration.



Energy Savings:

The spa will be in economy mode during the peak hours of the day and resume normal mode on the weekend.



Super Energy Savings:

The spa will always be in economy mode during peak hours, every day of the week.



Weekender:

The spa will be in economy mode from Monday to Friday, and will run normally on the weekend.



Application

Modifying schedules

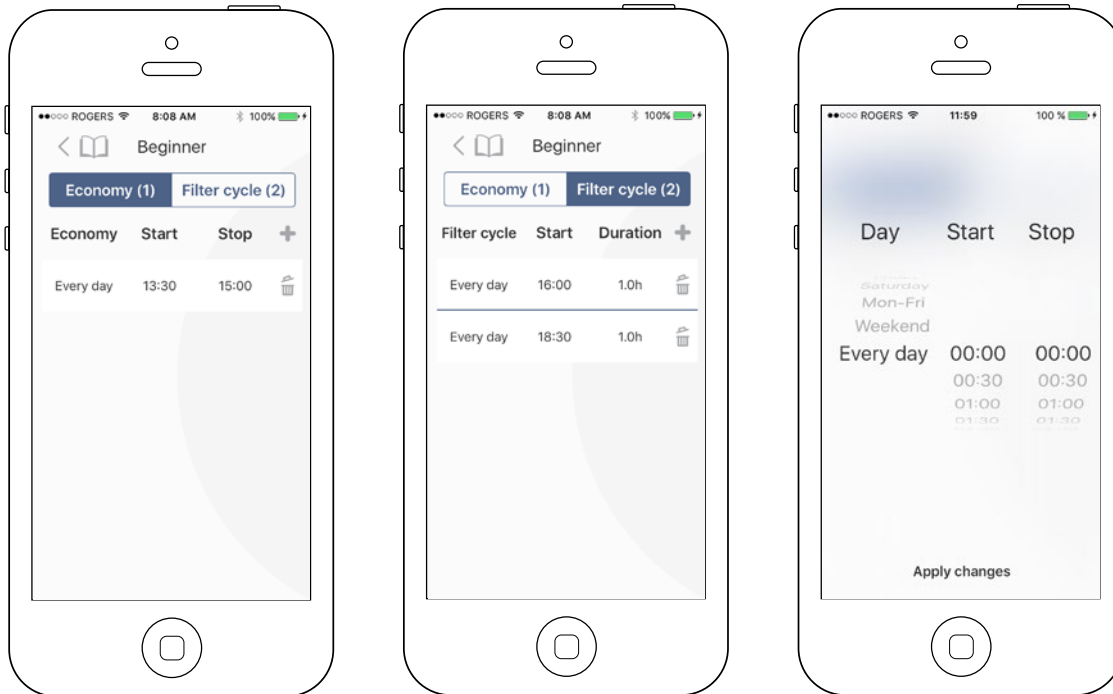

In this menu it is possible to add, remove or edit schedules of economy or filtration.

Touch the Economy tab to modify the economy schedules and Filter cycle tab for the filtration schedules. You can add economy or filtration schedules by touching the « + » symbol.

To delete a schedule, touch the garbage can icon at the right end of the desired line.

You can modify the programmed schedules by selecting one and adjusting the schedule.

You have several possibilities for the schedule (Mon-Fri, weekend, every day, or single days). The schedules will be repeated weekly. The time and duration are set in 30 minute increments. Once you have set the schedule, use the arrow at the top of the page to go back. Ensure that you have selected the desired Water Care mode in the main Water Care menu.

When an economy schedule is active, the set point will be reduced by 20°F, which means that the heating system will not be engaged unless the temperature falls to 20°F below the spa's set temperature.

The filtration schedule is applied to the main filtration pump, most likely pump 1. If your spa uses a circulation pump configured to run 24 hours, the screen will show purge schedules instead of filtration. The purges are pre-programmed for a fixed number of minutes, therefore the duration will be set to N/A on the screen and only the start time can be modified.



Application

Settings

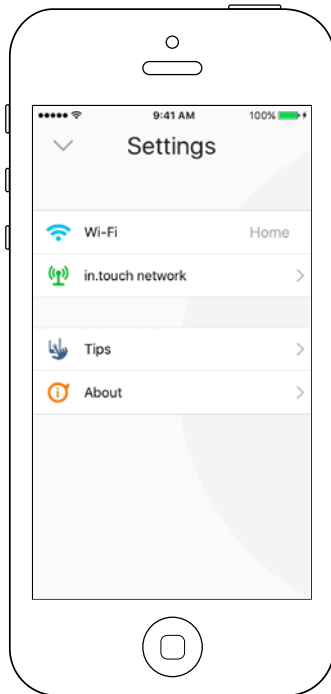

In the Settings page you can access the following:

- *Wi-Fi*
- *in.touch network*
- *Tips*
- *About*

To select an item, tap on the arrow next to it. It will open the selected menu.

Wi-Fi

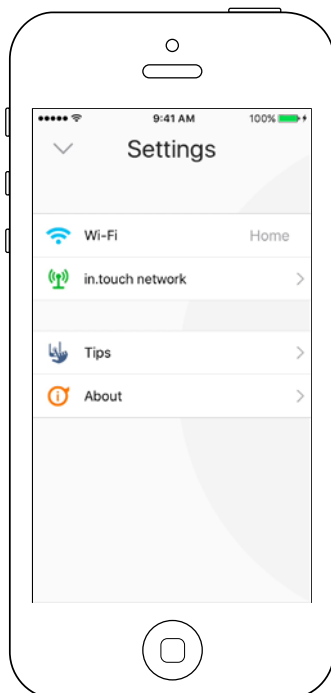

In the settings menu the Wi-Fi line indicates to which network your mobile device is actually connected.



Application

in.touch network

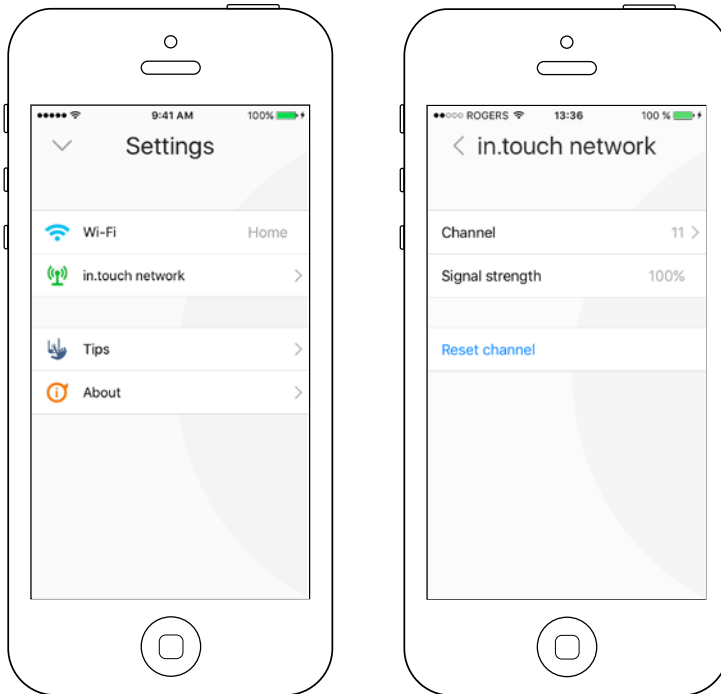

The in.touch network menu allows you to have access to information concerning the RF connection parameters between the in.touch 2-EN and in.touch 2-CO modules. This menu gives you access to:

- *Channel*
- *Signal strength*
- *Reset channel (resets channel to ... default)*

To change channels, press on the Channel line.

Change channel



The Change channel page allows you to change the channel used by the two in.touch 2 modules.

In some cases it is possible this will help you to have a stronger signal.



Application

Tips

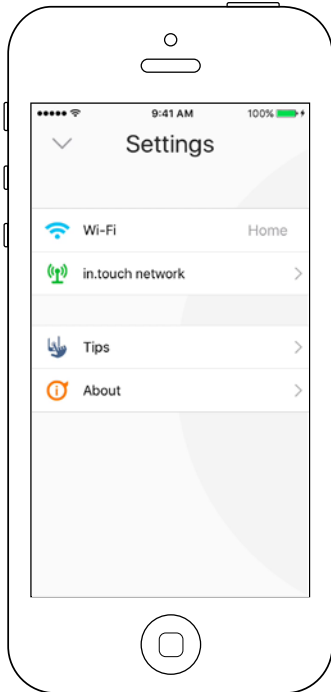

This section gives you a quick overview of your in.touch 2 application's functions.

About

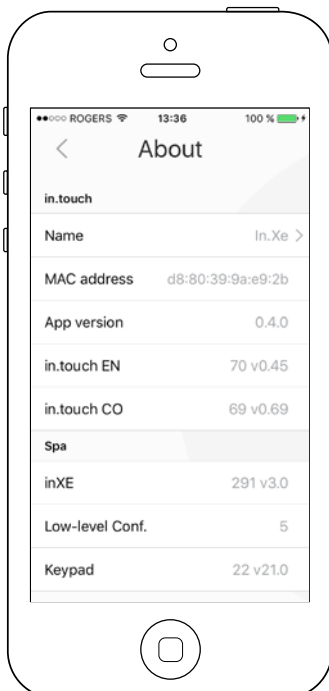

This section shows information about the in.touch 2 software number and the revision numbers of the different components of your system.

To modify your spa's name, you may press on the Name menu.



Application

Name

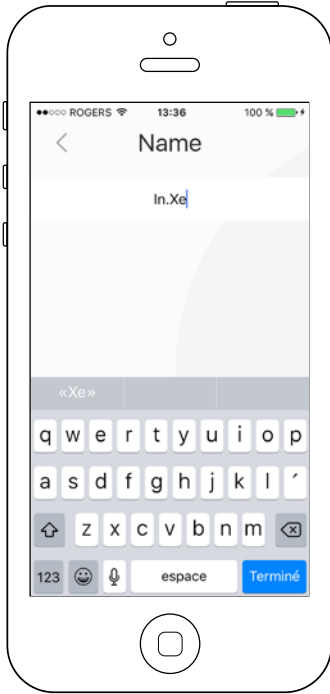

This section allows you to edit the name of the spa.



Troubleshooting

Both in.touch 2 modules have a status LED to help diagnose problems, if any occur.

Troubleshooting

There are 2 different modules in the in.touch 2 kit: the in.touch 2-EN for the home transmitter and the in.touch 2-CO for the spa transmitter. They communicate together via an RF link. The in.touch 2-EN is responsible for the Ethernet communications and the in.touch 2-CO is responsible for the spa communications.

in.touch 2-EN (home) status LED

This module's LED can show various status conditions, as indicated below.

Rapidly flashing YELLOW color:

The in.touch 2-EN is in pairing mode when this color is shown (the pairing switch was pressed). Until a pairing successfully completes, the application cannot connect to the spa. To complete the pairing, you must turn off the spa (using its breaker), wait a few seconds and then flip back the breaker to on. The pairing will then occur within a few seconds. If not, then the in.touch 2-CO on the spa is either incorrectly connected, out of range, or defective.

If the in.touch 2 modules were previously paired and the pairing switch is accidentally pressed, simply unplug the in.touch 2-EN USB power cord and re-plug it (thereby resetting the in.touch 2-EN module). The modules should then normally reconnect together.

Once out of pairing mode, the in.touch 2-EN will display another color.

For each of the following colors, the information applies whether the LED is blinking or not. If the LED is blinking, please also refer to the Blinking LED section below.

RED color:

Reason?

The in.touch 2-EN is not detecting a router. Until this is resolved, the application cannot connect to the spa.

What to do?

Make sure the router is powered and working correctly (i.e. test it using another computer or device connected to the same LAN port you intend to use).

Make sure the Ethernet cable is correctly connected at each end (LAN port on router end, and in.touch2-EN.) If the problem still occurs, try connecting with another cable. If a computer (or other device) works fine on the LAN port, and the cable is fine, then the in.touch 2-EN is likely defective.

GREEN color:

Reason?

The in.touch 2-EN is connected to a router (an IP address was assigned), but the in.touch 2 server is not reachable.

What to do?

This is very likely a router configuration issue, so refer to your router's User Manual.

It may be due to Port 10022 being closed. Normally, this port is open by default in commercial routers, but different routers may have different behaviors.

If Port 10022 is confirmed as open, then some other internal configuration is preventing the router from accessing Internet. In this case, the application will still have access to the spa if connected to the same network.

The server may also simply be temporarily "offline" for servicing/maintenance, so try again later. The application can still connect with the spa, but only from within the same network.

If the application can connect to a local spa, the problem is likely the Internet connection (WAN), a router mis-configuration, or your Internet Service Provider (ISP) has issues with its network connection.

BLUE color:

Reason?

This is the normal state of the in.touch2-EN LED. It has a full Internet connection, with access to the in.touch 2 server. As long as your device and application have access to the Internet (either via WiFi or cellular data such as 3G, 4G, or LTE), then you're good to go!

What to do?

Enjoy your spa!



Troubleshooting

in.touch 2-CO (spa) status LED

This module's LED can show various status conditions, as shown below.

Rapidly flashing YELLOW color:

The in.touch 2-CO is in pairing mode when this color is shown. This normally briefly occurs automatically during power-up of the spa (i.e. right after the breaker is flipped on). This could also occur if the in.touch 2-CO was never paired (which is very unlikely, as they are shipped paired from factory). Refer to the pairing section if your unit has not been paired, so you may complete the process.

BLUE color:

Reason?

This is the normal state of the in.touch2-CO LED. If the in.touch 2-EN module also shows solid blue, you are all set! If this LED is blinking, refer to the Blinking LED section below.

What to do?

Enjoy your spa!

Blinking LED:

On both modules, if the LED is blinking about once per second, it means that the RF link is not established between them (i.e. each in.touch 2 module cannot communicate with its counterpart). This can occur for several reasons.

Review the following and perform the tests in the order given below.

Unpaired:

As the modules are shipped paired from the factory, this is not a likely cause, but it is the easiest test to perform in the field. Simply attempt to pair them again. Please refer to the Pairing section for instructions on pairing.

Modules out of range:

If the pairing test above does not resolve the problem, then the modules may be too far from each other for an effective RF link. To test this, simply connect the in.touch 2-EN outside, close to the spa (via an extension cord for power).

A router connection is not needed for this test. If the module LEDs no longer blink, an RF link was established which confirms the hypothesis that the modules were too far apart. Getting the modules closer together somehow is the only solution.

If moving the modules closer together does not stop the LEDs from blinking, attempt to pair them again. If this pairing fails even though the RF modules are near each other, then one or both of the modules are defective, replace them.



Specifications

Environmental

Humidity:	Up to 85% non condensing
Operating temperature:	-4°F (-20°C) to 140°F (60°C)
Storage temperature:	-22°F (-30°C) to 185°F (85°C)
Water ingress protection:	IPX5 for CO module

Compatibility

in.yt, in.ye, in.yj, in.xe, or in.xm2 spa systems manufactured in or after 2012.

Regulatory Compliance Information

United States

Contains FCC ID: OA3MRF89XAM9A

This device complies with Part 15 of the FCC Rules.

Operation is subject to the following two conditions:

(1) this device may not cause harmful interference, and (2) this device must accept any interference received, including interference that may cause undesired operation.

This equipment has been tested and found to comply with the limits for a Class B digital device, pursuant to part 15 of the FCC Rules. These limits are designed to provide reasonable protection against harmful interference in a residential installation. This equipment generates, uses and can radiate radio frequency energy, and if not installed and used in accordance with the instructions, may cause harmful interference to radio communications. However, there is no guarantee that interference will not occur in a particular installation. If this equipment does cause harmful interference to radio or television reception, which can be determined by turning the equipment off and on, the user is encouraged to try to correct the interference by one or more of the following measures:

- Reorient or relocate the receiving antenna.
- Increase the separation between the equipment and receiver.
- Connect the equipment into an outlet on a circuit different from that to which the receiver is connected.
- Consult the dealer or an experienced radio/TV technician for help.

To satisfy FCC RF Exposure requirements for mobile and base station transmission devices, a separation distance of 20 cm or more should be maintained between the antenna of this device and persons during operation. To ensure compliance, operation at closer than this distance is not recommended. The antenna(s) used for this transmitter must not be co-located or operating in conjunction with any other antenna or transmitter.

Canada

Contains IC: 7693A-89XAM9A

Europe

The module has been certified for use in European countries.

The following tests have been completed, and passed:

Test standard ETSI EN 300 220-2 V2.3.1 (2010-02):

- Frequency error & drift
- Effective radiated power
- Transient power
- Modulation bandwidth
- Unwanted emissions in the spurious domain
- Receiver spurious radiation



Specifications

Test standard ETSI EN 301 489-3 V1.4.1 (2002-08):

- Conducted emissions
- Radiated emissions
- Radiated immunity

The in.touch 2-EN and in.touch 2-CO modules are fully compliant with:

- Radiated emissions (EN 55022)
- Electrostatic discharge (EN 61000-4-2)
- EN 60950-1
- CE mark
- RoHS



Class 2 low-voltage Interface Box,
Model in.TR, Option IT, File E182156.



The product must be disposed of separately in accordance with the local waste disposal legislation in force.



9919-101517-A
Rev. 11-2016

© Groupe Gecko Alliance inc., 2016
All trademarks or registered trademarks
are the property of their respective owners.

Gecko Alliance
450 des Canetons, Québec (Qc), G2E 5W6 Canada, 1.800.78.GECKO
www.geckoalliance.com

Printed in Canada