



in.xm2™



Mid-range spa pack platform

TechBook

Featuring in.therm™ remote heater



Aeware  [®]
by GECKO



Table of contents

introduction	3	spa pack error codes	
warnings	4	- spa pack error codes	31
features	5	- spa pack corrective actions	33
overview		heater error codes	
- in.xm2™ overview	8	- RH error codes	37
- in.xm2™ dimensions	9	- RH corrective actions	39
installation		error codes	
- floor installation.....	10	- error codes	43
- wall installation	11	- corrective actions	45
connections		- accessories corrective actions	49
- electrical wiring	12	testing the ozonator.....	50
- in.link™ connectors	16	gfc trips	51
in.scan	17	in.k600™ keypad function description	52
firmware upload	18	viewing current management data	
configuration upload.....	19	- tech menu	53
installer options.....	20	in.therm™	
in.xm2™ configuration		overview	59
- boot up displayed sequence	22	installation.....	60
- learning mode	23	connecting in.therm™ to in.xm2™	61
- current check	23	specifications	62
troubleshooting section			
interface	30		



Aewarei 3
by GECKO .[®]



in.xm2

inventive spa pack platform

Our innovative in.xm spa pack platform includes all the features and functions the spa and hot tub industry expects in a stunning power box design that breaks all rules and standards with its superb combination of looks and functionality.

Like the in.xe, its little brother, the in.xm is sturdy, compact and thin. Its small footprint makes it a perfect fit in any crowded spa equipment compartment, while still providing options for multiple pumps and accessories.

The in.xm2 can be wall-mounted or installed on its mounting base and comes with a perfect companion, our in.therm intelligent remote water heating system.

Ground-breaking features for unsurpassed innovation, reliability and safety.

**WARNINGS:**

Before installing or connecting the unit, please read the following.

- * FOR UNITS FOR USE IN OTHER THAN SINGLE-FAMILY DWELLINGS, A CLEARLY LABELED EMERGENCY SWITCH SHALL BE PROVIDED AS PART OF THE INSTALLATION. THE SWITCH SHALL BE READILY ACCESSIBLE TO THE OCCUPANTS AND SHALL BE INSTALLED AT LEAST 5' (1.52 M) AWAY, ADJACENT TO, AND WITHIN SIGHT OF THE UNIT.
- * ANY DAMAGED CABLE MUST BE IMMEDIATELY REPLACED.
- * TURN POWER OFF BEFORE SERVICING OR MODIFYING ANY CABLE CONNECTIONS IN THIS UNIT.
- * TO PREVENT ELECTRIC SHOCK HAZARD AND/OR WATER DAMAGE TO THIS PACK, ALL UNUSED RECEPTACLES MUST HAVE A DUMMY PLUG.
- * THIS PACK MUST NOT BE INSTALLED IN PROXIMITY OF HIGHLY FLAMMABLE MATERIALS.



The in.xm2 boasts a long list of technical features. Each of them contributes to bringing the most advanced solutions available to in.xm2 equipped spa owners:



in.put
input terminal block

In.put was designed to ease wire insertion (up to # 4 AWG) and connections. Tighter input connection reduces heat generated for increased component lifetime.



in.seal
watertight protection

In.seal provides extra level of protection against water infiltration. Connectors and power box are designed to be watertight and no water can be in direct contact with electrical components. (IPX5)



in.axess
board access prevention

Electronic components are placed into separate and inaccessible compartments. Only serviceable parts are made accessible to service technicians.



in.kin
kinetic heat monitoring

First ever UL approved kinetic heating protection manages water temp. increase generated by pump heat dissipation. Hardware protection shuts all accessories off if it senses water overheat.



in.flo
dry-fire protect

A heater safety system located in the in.therm power box with an all-electronic dry-fire protection.



in.t.cip
water temp. algorithm

In.t.cip is an intelligent water temp. refresh algorithm that calculates optimal time to start pumps and get water temp. readings. In.t.cip continuously readjusts heater start time.



in.link ingenious plugs and connectors

The in.xm2 is equipped with in.link professional cable technology to protect your pack and prevent mis-wiring. High-end connections for accessories are provided with color coding, snap locks, high-current contact and waterproof connections.

in.link output connectors:

Color	Output	Typical Device
Red	Rh	Remote Heater
Orange	P1	Pump 1
Purple	P2	Pump 2
Green	P3	Pump 3
Gray	O3	Ozone
Blue	BL	Blower
Green	CP	Circulation Pump
Orange	Di	Always on output (for in.play (audio/video accessories) or in.clear)

North
American
model



CE model





in.stick spa system configurator

The in.stik is a small in.link compatible memory stick, no bigger than a typical USB memory stick. It is used for uploading software and configuration information to spa packs, and as memory for data-logging during field testing.



The in.stik is used in the CO port of the in.xm2. It has an LED to show access status (LED blinks when memory is read from or written to). The in.stik also comes with a molded loop allowing tags to be attached to it. These tags can serve to identify various in.stik units (containing, different configuration options or different software revisions).

The in.stik is programmed at Gecko Alliance factories. It is typically used on OEM production lines to quickly set up packs, or by a dealer to update software if ever it is required.





In.xm2 overview

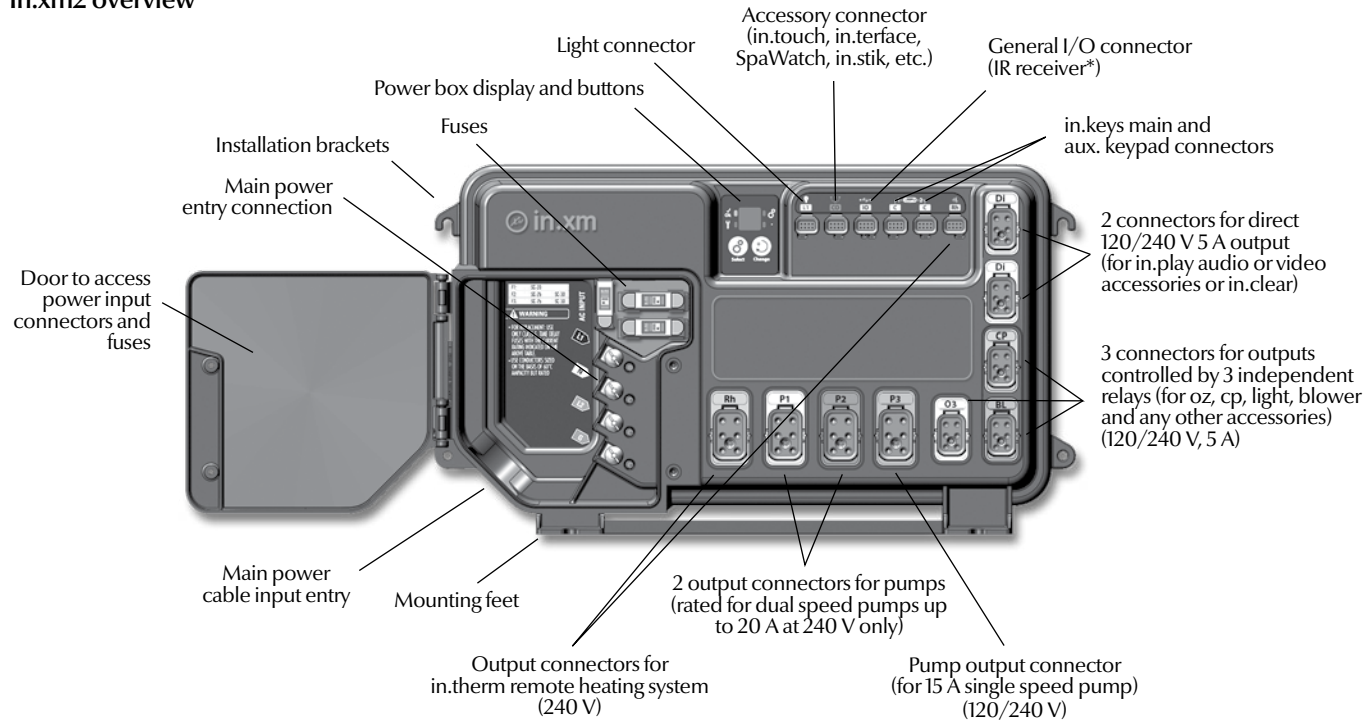

● Attention: output connector configuration is not the same in European models.

* IR receiver available on every LV connection except LI and RH



In.xm2 dimensions:

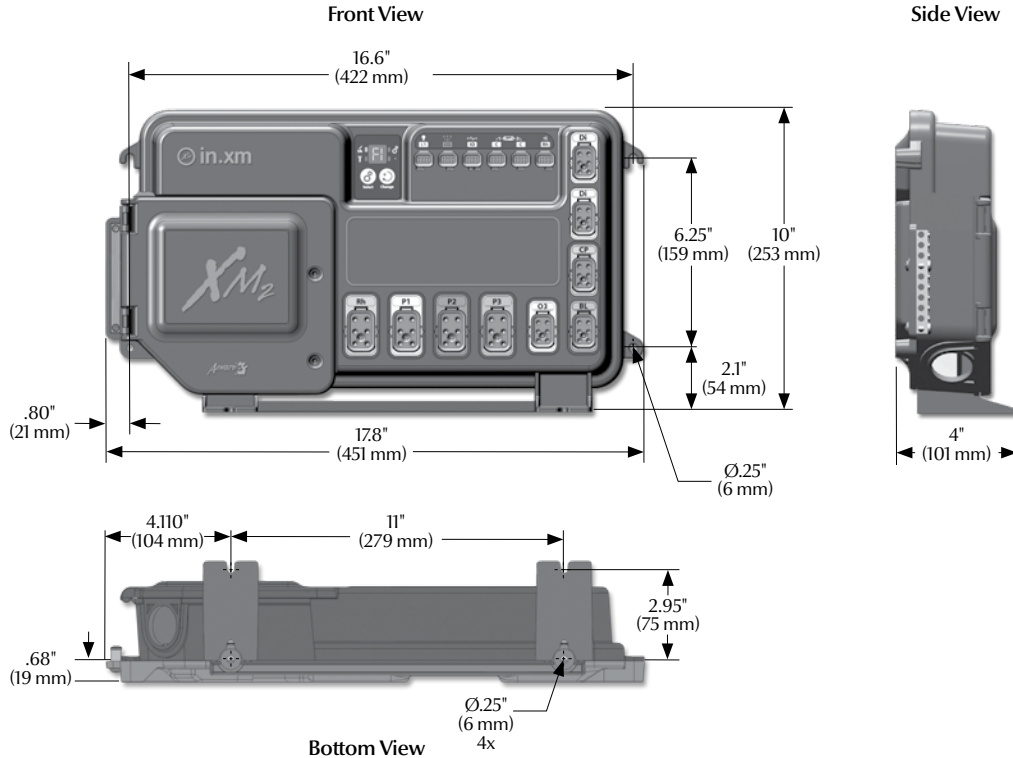



Floor installation procedure

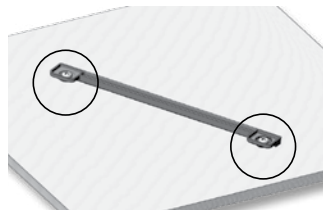

The following material is recommended:

4- # 10 screws of appropriate length with round, truss or pan head.

4- washers 1/2" OD x 1/16" thickness (12 mm OD x 1.5 mm)

Select the most appropriate location on the floor for spa pack and firmly attach guide plate to wooden base with 2 screws backed by 2 washers.

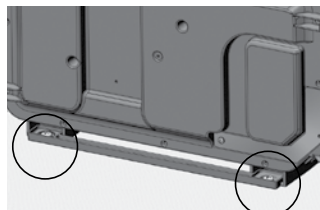

Slide back of the unit's feet into the guide plate. They should easily slide into place.

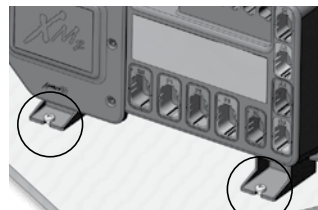

Now firmly attach unit to wooden base by using the remaining 2 screws backed by 2 washers to attach the front feet.

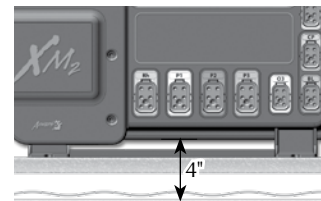

Note: The spa pack must be installed at least 4" (52 mm) above potential flood level. If floor is on ground level, pack should be raised at least 4" (52 mm).

Warning:

Beware the application of some products commonly used against corrosion (such as WD-40 family products) as they could damage the power box, due to a negative chemical reaction between some industrial oils and its plastic enclosure. Any other materials which may come in contact with the enclosure must be carefully evaluated under end use conditions for compatibility.

Important!

Please note that **countersunk** screws should **not** be used as they can damage the power box support.



Wall installation procedure

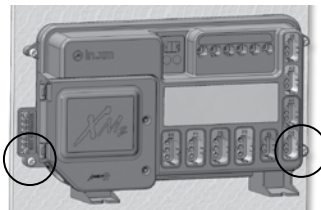
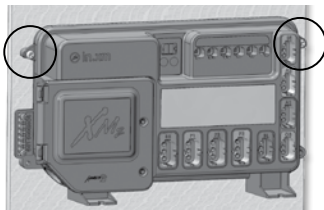
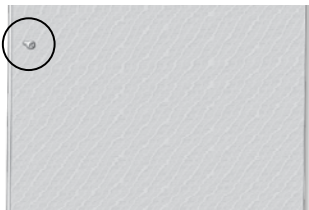

The following material is recommended:

4- # 10 screws of appropriate length with round, truss or pan head.

4- washers 1/2" OD x 1/16" thickness (12 mm OD x 1.5 mm)

Use two standard 2x4 or 2x6 wall studs, spaced on 17-inch centers to affix the spa pack.

Select the most appropriate location on wall for spa pack and firmly attach, one at the time, upper mounting holes on each side of the spa pack to wall with 2 screws backed by 2 washers.

Firmly attach lower mounting holes on each side of the pack with the 2 remaining screws and 2 washers.

Note: Make sure these 2 screws and 2 washers are installed. They will make the pack stable when input, outputs and accessories connectors will be manually inserted in their ports.



Electrical wiring

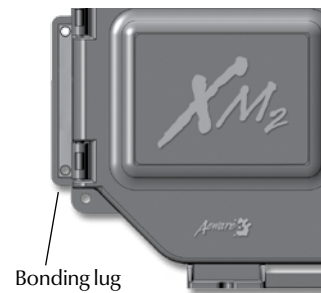
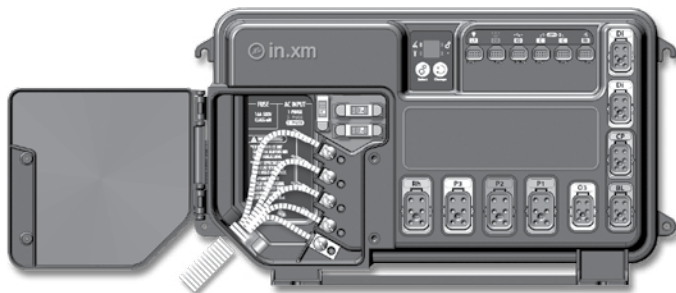

Bonding lug

To install the wiring for the in.xm.ce spa control, you'll need a Phillips screwdriver, a 14 mm (9/16") nut driver or a flat screw-driver. Loosen the 2 screws of the spa pack door and open it. Remove 200 mm (8") of cable insulation. Strip away 25 mm (1") of each wire insulation. Pull the cable through the cutout of the box (For CE use an IEC certified plastic bushing that will maintain the IPX5 rating). Also, the power cord must be in accordance with the national

electrical code of the country in which it's to be installed. Make sure that only the uncut wire sheathing is clamped at this opening. Push the color-coded wires into the terminals as indicated on the sticker, use the 14 mm (9/16") wrench or flat screwdriver to tighten the bolts on the terminals. After making sure wire connections are secure, push them back into the box and close the door. Tighten the 2 screws of the spa pack door.

Connect the bonding conductor to the bonding lug on the left side of the in.xm2 spa pack (a grounded electrode conductor shall be used to connect the equipment grounding conductors).

Important!

CE and UL /CSA parts are not interchangeable!



Electrical wiring

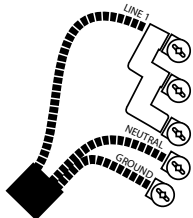

1 x 230 V (1 x 32A) Single-phase

See next page - Case 1

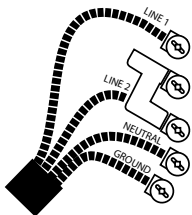

2 x 230 V (2 x 16A) Dual-phase*

See next page - Case 2

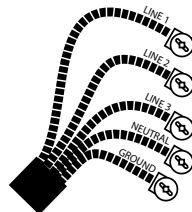

3 x 230 V (3 x 16A) Three-phase

See next page - Case 3

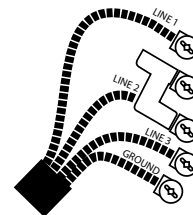

3 x 230 V (3 x 16A)
Three-phase (Delta)

See next page - Case 2

An IEC certified bushing that will maintain the IPX5 rating must be used. The power cord must be in accordance with the national electrical code of the country in which the in.xm2.ce is to be installed.

*Dual-phase system: two electrical phases out of a three-phase power system. It's important to note that on a polyphase power system, all electrical phases must share the same neutral.



Warning!

This product must always be connected to a circuit protected by a residual-current device (RCD) having a rated operating residual-current not exceeding 30 mA. Proper wiring of the electrical service box, RCD and in.xm2.ce terminal block is essential! Check your electrical code for local regulations. Only copper wire should be used, never aluminum.



Electrical wiring in.xm2.ce



Case 1

The installation of electrical circuit jumpers is needed in certain input supply configurations.

Use uncut jumper as supplied in the case of an input supply wiring, single-phase 1 x 230 V (40A max).

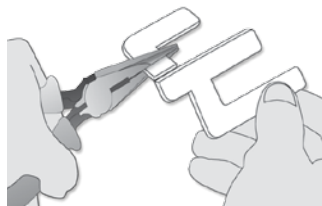

Case 2

In the case of an input supply wiring for a dual phase system 2 x 230 V (2 x 20A max), you'll need to cut off a portion of the jumper piece.

Proceed as follows:

Use a pair of pliers to firmly hold the upper half of the metal jumper, then break off the other half.

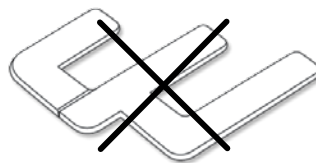

Case 3

Please note that in a 3-phase system 1 x 230 V (3 x 16A) No jumper installation is required.



Important!

Safely dispose of the discarded portion in accordance with the local waste disposal legislation in force.



Electrical wiring



Main electrical box GFCI panel

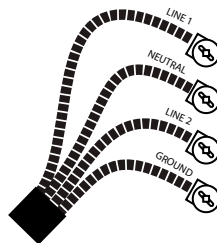

For 240 V (4 wires)

Correct wiring of the electrical service box, GFCI, and pack terminal block is essential. Call an electrician if necessary.

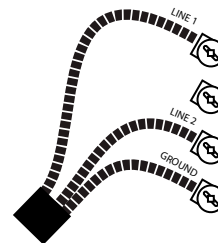

For 240 V (*3 wires)

*If connected to a 3 wire system (without neutral), all 120 V components will not work.



Warning!

"For units for use in other than single-family dwellings, a clearly labeled emergency switch shall be provided as part of the installation. The switch shall be readily accessible to the occupants and shall be installed at least 5 feet (1.52 m) away, adjacent to, and within sight of the unit".



Warning!

This product must always be connected to a circuit protected by a ground fault interrupter. Proper wiring of the electrical service box, GFCI and in.xm2 terminal block is essential! Check your electrical code for local regulations. Only copper wire should be used, never aluminum.

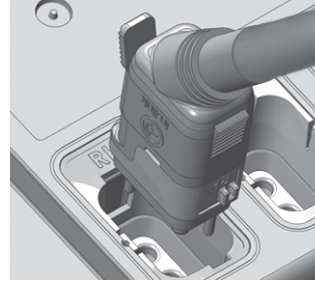
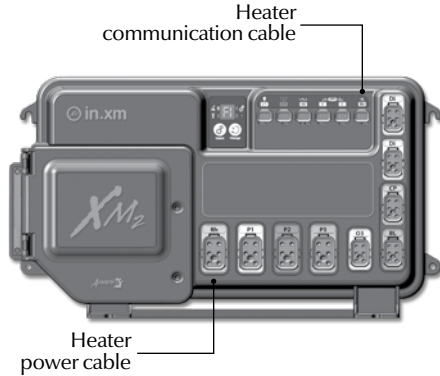

in.link connectors

In.xm2 features in.link connectors with colored and tagged polarizers. This new plug and connector technology has been specifically designed for easy and safe assembly. The tags are interchangeable depending on the output; the polarizers are designed to avoid misconnections.

In.link connectors are easily and conveniently accessible from the front of the pack offering a wide range of possible connection configurations. In.link connectors come in 3 sizes (HC, LC and low voltage) for all types of inputs and output devices.

They all include an integrated latch that keeps them safely in place and provides audible and tactile feedback when properly connected.

Finally, colored and tagged polarizers provide a definite advantage in reducing SKU numbers and inventory levels thus giving OEMs and dealers total flexibility to easily configure output devices.

All receptacles will match the corresponding female connection on the spa pack. No connectors should remain unplugged. Use blank plugs to fill unused connectors.

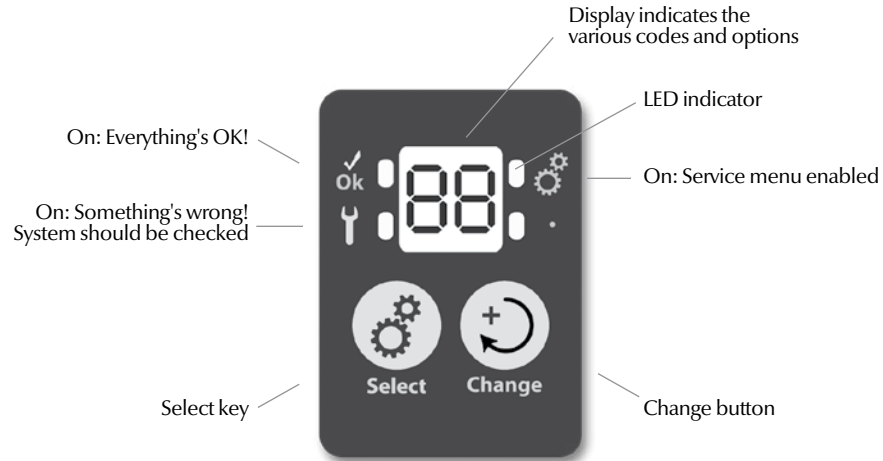

In.scan is an integrated tool for easy diagnostics and setup of the spa pack. It includes a small 2-character display with 2 keys, as well as 4 LED indicators (1 green and 3 red).

Select and Change keys are used in the Service Menu; this menu is used for several purposes:

- Setting input current ratings
- Setting dealer and other advanced options





Warning!

The in.stik must not be inserted or removed while the in.xm2 is powered. This may otherwise damage either the in.stik or the in.xm2; this will not be covered by the warranty. To insert or remove the in.stik first make sure the breaker supplying the in.xm2 is off.

Firmware upload

The in.xm2 firmware can be easily reprogrammed using an in.stik. If an in.stik (preprogrammed with valid firmware) is detected when the in.xm2 is powered up, the in.xm2 firmware will be automatically reprogrammed within a few seconds. Note that when the firmware is reprogrammed, the configuration is lost as well. It will have to be reprogrammed using the in.stik too (using the same in.stik as the one used for updating the firmware.) This implies that if some changes were brought to the previous configuration (i.e. using the Low-level programming feature), these changes will be lost when the new configuration is loaded.

While a firmware is being downloaded, the in.xm2 display will toggle the dash bar  then  will be displayed. To confirm that the firmware was downloaded successfully, the in.xm2 pack and keypad will display .





Configuration upload

Note: In order to choose the proper low level please refer to the low level configuration chart of your specification.

All of the in.xm2 programmable options (Installer options, Dealer options, and OEM options) can be easily reprogrammed using an in.stik. If an in.stik is detected when the in.xm2 is powered up, the in.xm2 will download all the different configuration sets into its memory. The in.xm2 will then enter the Low-Level Configuration menu. This menu shows LL01, where 01 is the configuration number. Use the Change key on the in.xm2 pack or Up/Down key on the keypad to choose the desired configuration number and press the Select key on the in.xm2 pack or Program key on the keypad to confirm the selected configuration. The system will remain in this menu until the Select key (pack) or Program key (keypad) is pressed.

To re-enter the low level programming menu (without having to use an in.stik) simply press and hold the Select key on the in.xm2 pack for 5 seconds or press and hold Pump #1 key (15 seconds) until "LL" is displayed on the keypad and quickly press on the Program key. Your previous chosen configuration (ex: LL03) will be displayed on the pack and keypad. Use the Change key on the in.xm2 pack or Up/Down key on the keypad to choose the desired configuration number and press the Select key on the in.xm2 pack or Program key on the keypad to confirm the selected configuration. If the Select key (pack) or Program key (keypad) is

not pressed within 30 seconds, the unit will exit this menu without changing any options.

Note: If the keypad used does not have a Program key, all programming functions are performed via the Light key. The low level programming is not compatible with the in.k600 graphic LCD keypad. You must use the Select and Change keys on the in.xm2. Once it is done, the next step will be to set the Installer option (phases and breaker size).

Parameter code	Display	Possible values
LL --	Low-level configuration (presets)	01 to XX (depending on available configurations) (01)

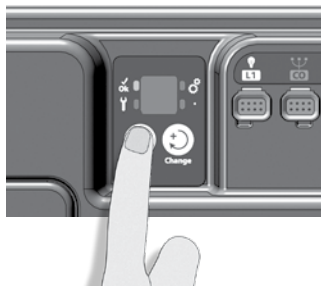

Installer options

The Installer options can be accessed via a short press of Select key on the in.xm2. When using Select key, the modified by using Change key. Use the Select key again to validate a setting, and move on to the next one or confirm change. If no key is pressed for 30 seconds, the in.xm2 will exit the menu without saving. The in.scan display will show the breaker setting menu.

Parameter	Display	Options	Description
Nb of phases	Ph --	1P, 2P or 3P (only on CE pack)	Available household supply current
Input current	br --	As programmed, up to 5 different values available	Available household supply current

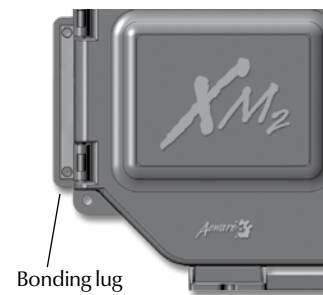

Bonding lug

Make sure all accessories are linked to the bonding connector and connected to pack.

Make sure the spa pack door is closed.

Turn on the breaker.

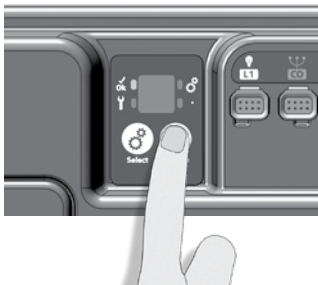

First parameter

Ph values displayed by the system correspond to number of phase.

This option is available only on the CE pack.

Ph 1	1 phase
Ph 2	2 phase
Ph 3	3 phase

Second parameter

Br values displayed by the system correspond to 0.8 of the maximum amperage capacity of the GFCI (for North America only).

It is important to specify the current rating of the GFCI used to insure safe and efficient current management (and no GFCI trippings).

GFCI	Br
60 Amp	48 Amp
50 Amp	40 Amp
40 Amp	32 Amp
30 Amp	20 Amp
20 Amp	16 Amp

Note: Every OEM has its own preset configurations. Some rating may not be available for some phase setting.



Description



Select

Select button is used to access the breaker setting menu (short press) as well as the low level programming menu (Press and hold for 5 seconds). Subsequent presses will save changes and display the next option available or exit automatically if it was the last one.



Change

Use Change button to change the parameters displayed.

Selecting Breaker (Br) settings



br

Press Select button once to activate the breaker setting menu. Once activated, the display shows "br" and, in succession, the maximum current rating of the breaker.



Press Change button to change setting.



Press Select to confirm. You will exit menu automatically (in.xm2 will also reset).

Boot up display sequence (for streamlined keypad)

Each parameter is displayed for 2 seconds

SP

Spa Pack

44

Low level software number

100

Low level software revision

rH

Remote heater

501

Remote heater software number

500

Remote heater software revision



Learning mode

Note: Selected Software's version do not offer learning mode. Do not read this section if you do not have this feature.

The in.xm2 pack has the ability to verify and "learn" the current consumption of every output connected to it.

After breaker setting is done, if the low level configuration has been changed, the system will start learning the current of each output and keep the values in memory.

This values will be used for the power management. This mechanism makes sure the system will not over load the capacity of the breaker setting.

If there are values written in the low level configuration or if there are values entered in the Dealer's option (see nominal current page 26), those values becomes the one used for the power management.

Current check

After the learning, the display will show the first accessory "P1" and the current learned "XX" (xx represents the current value read during the learning mode) the display will alternate between the two. By pressing Up or Down key you will see the next accessory and its learned current and so on.

The system will return back to normal mode either by pressing the Light or Prog. key or after 1 minute if no keys are pressed.

Note: if unusual current readings e.g.: 4 to 6 amps are detected on the high speed of any pump, all pumps must be primed and the learning mode should be restarted.

If an output is replaced, a new learning must be done. Follow these simple steps:



LL

Press and hold **Select** button for 5 seconds to activate low level programming. Once activated, the display shows "LL" and, in succession, the current preset low level configuration selected.



Press **Change** button repeatedly to select the same preset low level configuration again.



Press **Select** to confirm. You will exit menu automatically. The in.xm2 will then reset. After resetting, the system starts a "learning sequence" in which each individual output is activated and its peak current displayed and saved.

Note: Every OEM has its own preset configurations.



Dealer options

The Dealer options can be accessed via a long press of the Pump #1 key on the keypad (except in.k600 with graphic LCD) and does not require the in.stik. To enter the menu, press and hold Pump #1 key (25 seconds) until “LLPr” displayed on the keypad and quickly press on the Program key. The different parameters can be modified by using the Up/Down key. Use the Program key again to validate a setting, and move on to the next one. All parameters must be validated with the Program key. If no key is pressed for 1 minute, the in.xm2 will exit the options menu without saving and will reset the pack.

At the last parameter (d.--), pressing the Program key again exits the menu and saves your settings. Then, the pack will reset and the Installer options menu (Number of phases Ph- on CE model and Input current br- selection) will display. At this time, the selection can be made by the in.xm2 pack keys or the keypad keys.

Note: If the keypad used does not have a Program key, all programming functions are via the Light key.

In all tables, a dash in the parameter display (i.e. Ph--) indicates a placeholder, which is normally an option value, as shown in the tables.

WARNING: Improper configuration of these options may produce erratic spa operation. Only qualified spa technicians should be allowed to change these settings at any time.

In the event that the spa does not function correctly due to incorrectly field-programmed options, the spa technician can always retrieve the Low Level configuration values.



Dealer options (Some settings do not show, depending on which micro software is installed.)

Parameter	Display	Options	Description
OUT1A	<input type="text" value="1"/>	See devices configuration table below.	Output #1A configuration
OUT1B	<input type="text" value="2"/>	See devices configuration chart below.	Output #1B configuration
OUT2A	<input type="text" value="3"/>	See devices configuration chart below.	Output #2A configuration
OUT2B	<input type="text" value="4"/>	See devices configuration chart below.	Output #2B configuration
OUT3A	<input type="text" value="5"/>	See devices configuration chart below.	Output #3A configuration
OUT4A	<input type="text" value="6"/>	See devices configuration chart below.	Output #4A configuration
OUT5A	<input type="text" value="7"/>	See devices configuration chart below.	Output #5A configuration
OUT6A	<input type="text" value="8"/>	See devices configuration chart below.	Output #6A configuration
OUT7A	<input type="text" value="9"/>	See devices configuration chart below.	Output #7A configuration
Direct Accessory	<input type="text" value="d"/>	Not installed = nA Circulation pump = CP	Circulation pump is installed on the direct output (not controllable by a relay)
CP Usage	<input type="text" value="CU"/>	Standard = 0 Always ON = 1	Usage of the circulation pump



Parameter	Display	Options	Description
Ozone Usage		During filter = 0 Follow the associated pump = 1	Usage of the ozone generator
Ozone Pump		Circulation pump = 0 Pump #1 = 1	Pump associated to ozone generator
Heater Pump		Circulation pump = 0 Pump #1 = 1	Pump associated with the heater
Water Clean CP		No action = 0 Filtration cycle with Circ. Pump = 1	Circulation Pump action during filtration cycle
CP Always ON		No action = 0 Always on = 1	Circulation Pump configuration
Filter Interface		Purge only = 0 With Circulation Pump = 1 With Pump #1 = 2	Filter interface configuration
Ozone Pump		Not follow the associated pump = 0 Follow the associated pump = 1	Ozone generator action with associated pump
Ozone During Filtration		No action during clean step = 0 During clean step = 1	Ozone generator action during clean step
Nominal Current OUTIA		0.0 to 20.0 amperes on UL pack * 0.0 to 16.0 amperes on CE pack *	Output #1A current



Parameter	Display	Options	Description
Nominal Current OUT1B	<input type="text" value="2.--"/>	0.0 to 15.0 amperes on UL pack * 0.0 to 16.0 amperes on CE pack *	Output #1B current
Nominal Current OUT2A	<input type="text" value="3.--"/>	0.0 to 20.0 amperes on UL pack * 0.0 to 16.0 amperes on CE pack *	Output #2A current
Nominal Current OUT2B	<input type="text" value="4.--"/>	0.0 to 15.0 amperes on UL pack * 0.0 to 16.0 amperes on CE pack *	Output #2B current
Nominal Current OUT3A	<input type="text" value="5.--"/>	0.0 to 15.0 amperes on UL pack * 0.0 to 16.0 amperes on CE pack *	Output #3A current
Nominal Current OUT4A	<input type="text" value="6.--"/>	0.0 to 10.0 amperes *	Output #4A current
Nominal Current OUT5A	<input type="text" value="7.--"/>	0.0 to 10.0 amperes *	Output #5A current
Nominal Current OUT6A	<input type="text" value="8.--"/>	0.0 to 10.0 amperes *	Output #6A current
Nominal Current OUT7A	<input type="text" value="9.--"/>	0.0 to 10.0 amperes *	Direct accessory output current
Direct Current	<input type="text" value="d.--"/>	0.0 to 10.0 amperes *	Direct accessory output current

* If 0.0 ampere is configured for output(s) current, the learned value(s) will be use.



Devices configuration table

Devices	Display	Devices	Display
Not installed	nA	Ozone Generator	03
Pump #1 High Speed	P1H	120/230 V Light	L2
Pump #1 Low Speed	P1L	Heater ** (Not allowed)	H
Pump #2 High Speed	P2H	12V Light ** (Not allowed)	L1
Pump #2 Low Speed	P2L	Fan	FAn
Pump #3 High Speed	P3H	Fiber box Motor	Fbr
Pump #3 Low Speed * (Not Supported)	P3L	Fiber box Light	FbL
Pump #4 High Speed	P4H	Direct (Always ON)	dLr
Pump #4 Low Speed * (Not supported)	P4L	TV Lifter (Screen)	Scr
Pump #5	P5	Speaker Lifter (Sound)	Snd
Blower	bLo	Sanitation	SAAn
Circulation Pump	CP	Onzen	OEn
		Rotary Valve	rot

Note: The possibility to chose the number of phases and the input current with the keypad, is only available after a low level programming or Dealer options modification.

* These devices are not supported.

** These values are not allowed. If you select one of these devices, the pack may produce erratic spa operation.



in.xm2

Mid-range spa pack platform



Troubleshooting section



Aeware  [®]
by GECKO



In.xm2 troubleshooting advantage

In.xm2 unique troubleshooting features are called in.scan because in.xm2 has the capacity to scan itself and read the status of all exterior connected devices.

All errors codes will be displayed on the keypad and on the in.xm2 display, making reading codes easier and more convenient.

Error codes

Error codes indicate a failure condition or a problem which needs to be corrected to ensure proper functioning of the system. Both the error code and device identification are alternatively displayed.

Note: Every OEM has its own preset configurations.

**FR - ER**

The input frequency (50/60 Hz) is out of range.

**SP - IN**

The input voltage is too low.

Either there is a problem with the terminal connections or with the power lines.

**F1**

in.xm2 Fuse F1 is blown.

Fan, blower, circulation pump, fiber optic

**F2**

in.xm2 Fuse F2 is blown.

Pump 2, Pump 3 or blower that is more than 5 amp

**F3**

In.xm2 Fuse F3 is blown.
Pump 1

**SP - OT**

Temperature inside the spa skirt is too high, causing the internal temperature in the in.xm2 to increase above normal limits (overheat condition).

**SP - OH & blinking temperature higher than 112°F on the keypad display**

The system detects spa water temperature exceeding 112°F (overheat condition).



Fr - Er

Input frequency (50/60 Hz) is out of range

- Was this error present since 1st power-up of the in.xm2?
If so, have a certified electrician to verify the power line quality.

SP - IN

Input voltage issue

- Check input terminal connections to make sure they are correctly wired & tighten (see connection section).
- Have a certified electrician verify the quality of the power lines.
You should have 240v between L1 & L2 and 120v between each line and neutral.



SP - F1

In.xm2 Fuse F1 is blown

- Replace the blown fuse F1 with an identically rated replacement (SC-20, SC-25, etc.)
- If new fuse blows, disconnect fan, blower, circulation pump & fiber optic.
- Replace fuse and reconnect all components, one at a time, until fuse blows.
- Replace component that caused fuse to blow.

SP - F2

In.xm2 Fuse F2 is blown

- Replace the blown fuse F2 with an identically rated replacement (SC-20, SC-25, etc.)
- If new fuse blows, disconnect pump 2, pump 3 or blower.
- Replace fuse and reconnect all components, one at a time, until fuse blows.
- Replace component that caused fuse to blow.



SP - F3

In.xm2 fuse F3 is blown

- Replace the blown fuse F3 with an identically rated replacement (SC-20, SC-25, etc.)
- If new fuse blows, Replace pump 1.

SP - OT

Internal hardware temp. is too high

- Remove spa skirt and let system cool down.
- A breaker reset may be required to clear error.

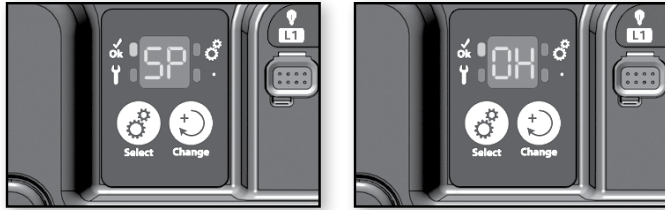

**SP - OH & blinking water temp. on the keypad display
water temperature exceeding 112°F is detected**

- Remove spa cover and let spa cool down.
- Add cold water and lower filter cycle.
- If the temperature cools down within normal limits the error will reset itself.
- If error persists, measure the temperature with a DIGITAL thermometer and compare its reading with temp. on the display. If temp. reading is different, replace in.therm™.
- If problem persists replace pack.

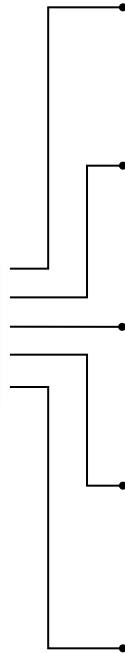

RH error codes

**RH - HR**

A hardware error was detected in in.therm (related to the electronic circuit only).

**RH - NH**

This error occurs if in.therm is trying to heat water but does not detect any increase in temperature.

**RH - NF**

This code is displayed when a “no flow” condition is detected by in.therm™.

**RH - NC**

Communication problem exists between in.xm2 and in.therm.

**RH - HL**

High Limit hardware circuit tripped.



RH error codes

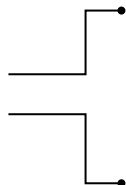

RH - PR

The system detects a problem with the regulation probe.
The system is constantly verifying if temperature probe readings are within normal limits.



RH - ID

The system detects a no match between the in.xm2 model and the in.therm model.



RH - HR

Internal hardware error detected in in.therm

- Reset main breaker; make sure the heater restarts by changing set point and turning every output On and Off (Pumps).
- If problem isn't corrected, replace in.therm.

RH - NH

A "no heat" issue is detected

- Verify if in.therm is properly connected. (You should hear a click!)
- Reset main breaker.
- Measure voltage directly on the Di connector (see illustration).
You should read:

240VAC at Di connector:
Pin 1 & Pin 2

120VAC at Di connector:
Pin 5 & Pin 6

120VAC at Di connector:
Pin 5 & Pin 2

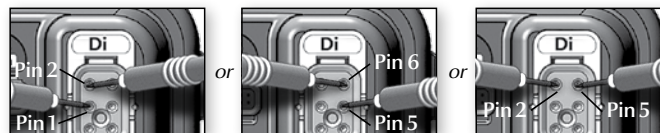

Note: 240VAC at Di connector will be the only reading possible if the installation doesn't have the neutral wire (3 wire 240VAC installation).

- If you don't get proper voltage readings, reset the main breaker.
- If you get an appropriate voltage reading, replace in.therm.

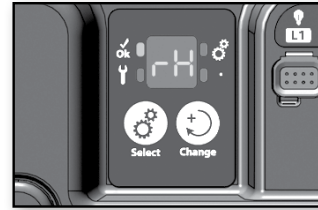

RH - NF "No flow" condition detected

- Make sure water valves are open and that water level is high enough.
- Check and clean filters.
- Make sure there are no air locks (or that no object obstructs the passage of water in the in.therm channel). Pumps may make strange noises and error messages such as "P1 ER" could appear. Follow air lock procedure to clear them.
- Make sure that the pump associated to the heater (Pump #1) is running by pressing P1 key.

If "P1 ER" appears on display, go to Pump 1 error section and follow procedure.

RH - HL High limit hardware circuit tripped.

There are 2 possible causes:

- The heater was previously stored in a very hot location prior to installation and there is no water yet in its tube to cool it down.
 - Use a hose to cool down the interior of the tube.
- External ambient temp. is high enough to heat the water, even though the pumps remain off.
 - Add cold water in spa and let heater cool down.
 - Reset spa pack using current breaker.



RH - NC

Communication problem between in.xm2 and in.therm

- Make sure remoter heater cable is correctly connected; then reset system; if condition persists, visually verify male connector pins to make sure they are not bent.

If the above does not solve problem, either in.xm or in.therm may need to be replaced.

RH - PR

A problem with the regulation probe is detected

- This error message clears itself when the condition that triggered the event is no longer present.
 - Reset the breaker.
- If problem persists, replace the in.therm.

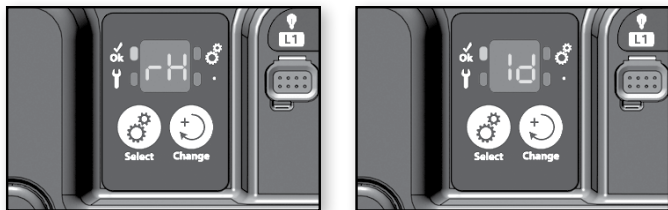

RH - ID

Incompatibility between the in.xm2 and in.therm models

The North American version of the in.xm2 pack can only be connected with the North American version of the in.therm heater. The same applies to the European version of both devices.

- The RH-ID message indicates that the European version of the in.therm heater (in.therm CE) has been connected to the North-American version of the in.xm2 pack (in.xm2 UL) or vice versa.

To correct the situation:

- Swap the in.therm or the in.xm2 for the appropriate version.



SC - ER

A scan error was detected.



AO - H

The in.xm2's internal temperature is $> 90^{\circ}\text{C}$ (194°F). At this stage, only the Light output is disable. However, if the in.xm2's internal temperature continues to rise above 100°C (212°F), nothing will work.



HR

A hardware error was detected in the in.therm or the in.xm2 pack.



FL - O

Occurs when a "no flow" condition is detected by the in.therm. At this stage, the check flow remains every 15 minutes.

**OH**

Spa water temperature is $> 44.5^{\circ}\text{C}$ (112.5°F). DO NOT ENTER WATER. At this stage, nothing works, except for Smart Winter Mode and the Light output.

**PR - R**

Temperature probe defective.

**HL**

The High Limit circuit has tripped. Usually, the Kinetic Heating protection shut down the heater and all accessories when this error occurs.

**SC**

This is not an error message. A solid Sc means the system is scanning all the output to learn the current draw of every accessory connected. This normally occurs at the 1st power-up.



SC - ER

System learning error

Every time a low-level option is changed, the system must “learn” the currents associated to each output/load. During this learning process, the device(s) connected to OUT8 (direct output, no relay) **must be disconnected (or off)**. If not, the system will report this error. Once the load is correctly disconnected, a press of any key reset the learning process again. Once the learning is finished, the accessories connected to OUT8 may be reconnected.



AO - H

The in.xm2's internal temperature is > 90°C (194°F)

At this stage, only the Light output is disable. However, if the in.xm2's internal temperature continues to rise above 100°C (212°F), nothing will work. This error clears itself when the error condition is no longer present. Open spa skirt and let system cool down.





HR

A hardware error was detected in the in.therm or the in.xm2 pack.

Add cold water to spa and let heater cool down. Disconnect the device(s) from the OUT8 (direct output, no relay) and reset the spa pack by shutting the breaker off than on again.

If problem still persists, replace in.xm pack. If not, reconnect the device(s) in OUT8 and reset the pack again. If the error comes back, replace the in.therm.



FL - O

Occurs when a “no flow” condition is detected by the in.therm. At this stage, the check flow remains every 15 minutes.

Make sure that the pump associated to the heater (Pump #1 or Circulation Pump) is running; check and clean filters; make sure water valves are open; make sure there is no air lock condition (or that any foreign object obstructs the passage of water within in.therm).



OH

Spa water temperature is $> 44.5^{\circ}\text{C}$ (112.5°F)

DO NOT ENTER WATER. At this stage, nothing works, except for Smart Winter Mode and the Light output.

This error messages clears itself when the condition that triggered the event is no longer present. Reset the breaker. If problem persists, replace the in.therm.



PR - R

Temperature probe defective

At this stage, only the Light output is disabled. However, if the in.xm2's internal temperature continues to rise above 38°C (100°F), nothing will work. This error clears itself when the error condition is no longer present. Open spa skirt and let system cool down.





HL High Limit circuit has tripped

The Kinetic Heating protection shuts down the heater and all accessories when this error occurs.

Add cold water to spa and let heater cool down; reset spa pack using current breaker.



SC This is not an error message

A solid Sc means the system is scanning all the outputs to learn the current draw of every accessory connected. This normally occurs at the 1st power-up.

Wait a few moments, and the message will clear itself.

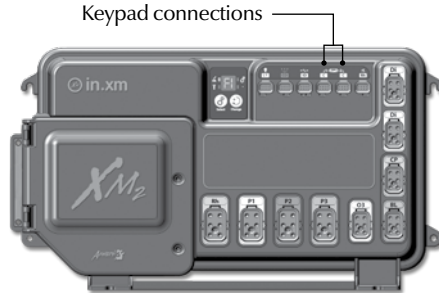

Keypad doesn't seem to work!

Note: Keypad connected to in.xm2 is only detected when main breaker is reset. Don't forget to reset breaker if you're changing keypad model (in.k400 for in.k600).

If a keypad doesn't seem to work:

- Verify keypad connections and try spare keypad.
- Replace keypad if problem is corrected.
- Replace in.xm2 if problem is not corrected.



Testing the ozonator

- Make sure ozonator is connected properly.
- Press and hold the change button until the message O3 flashes on display.
- Then, the system activates the pump associated to the ozonator (PI or CP) followed by the ozonator output.

Important: if the spa is equipped with the in.zone corona discharge ozonator, its LED indicator lights up to warn that the ozonator output has been activated.



Smart Winter Mode not a bug but a feature!

Our Smart Winter Mode protects your spa from water cold enough to freeze the pipes by automatically turning pumps on for one minute several times a day to prevent water from freezing in pipes.



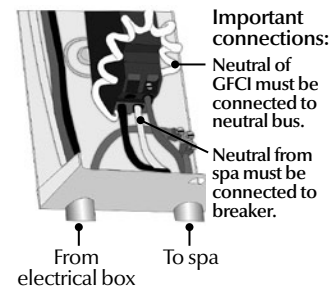
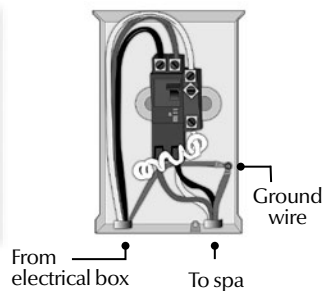
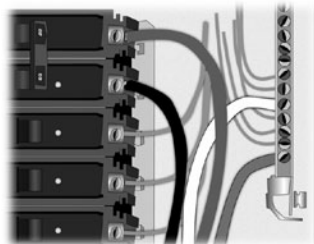
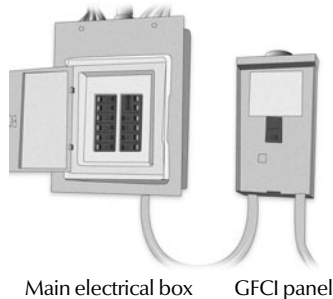

Warning!

There are different GFCI models used on the market. See manufacture's instructions that come with the GFCI for specific information. Note that all illustrations are examples only.

Verify if GFCI is properly connected.

If it's not, verify GFCI diagram and reconnect it.

Verify in.xm2 pack wiring (make sure that the neutral and the ground have not been inverted).

If the GFCI is properly connected but still tripping, unplug all outputs from the spa pack (pumps, heater, ozonator etc).

Reconnect one output at the time until the GFCI trips again.

Replace defective component.

Note: If the neutral of the GFCI is hooked up to the neutral bar, the in.xm2 spa control will only trip when the 120 V outputs are fired (e.g.: the ozonator)



In.k600 keypad menu driven interface

Multifunction Keys
1, 2, 3, 4

Each of these four keys helps you to select and/or execute the indicated function displayed on the screen in any given window. In this way, the task performed by a given multifunction key will vary depending on the menu or window.

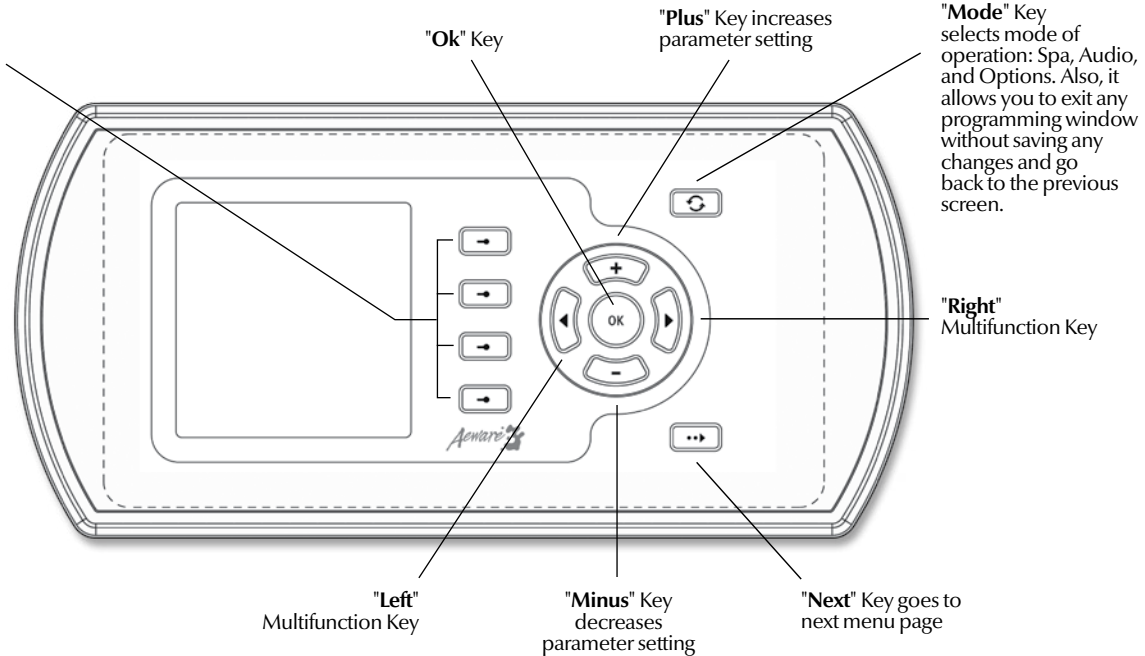

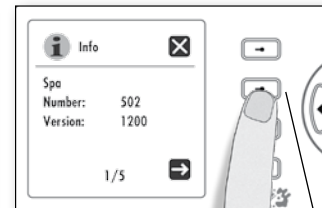
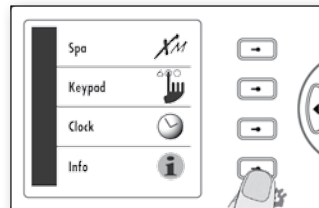
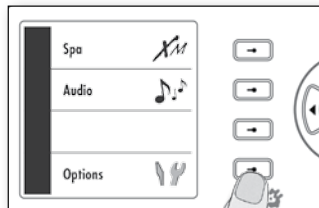

Multifunction key 2

Tech menu

- Press **Mode** key  to display the mode selection window.
- Select **Options** menu
- Select **Info** sub-menu

In the info sub-menu, you can find the information about the software number and revision of the spa pack, remote heater and keypad.

- Press and hold **Multifunction Key 2** for 5 seconds to access **Tech menu** (see next page).

** Option available with in.k600 menu driven keypad only.*

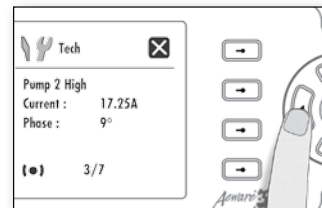
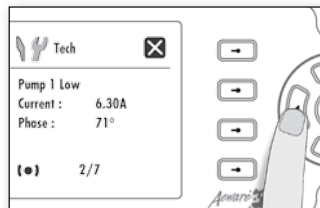
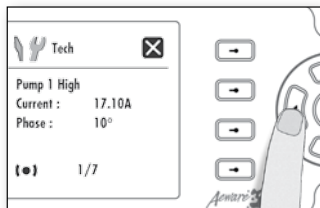

Tech menu

This menu allows you to view the speed (low or high in the case of the pumps), learned amperage data as well as the phase angle for each output.

Note:

If __ _ appears on any screen, it means that no significant current has been detected and "learned" by the system for that output.

Here Pump 1 high speed current and phase angle are displayed

- Use **Right** key to go to the next screen menu.

Here Pump 1 low speed current and phase angle are displayed

- Use **Right** key to go to the next screen menu.

Here Pump 2 high speed current and phase angle are displayed

- Use **Right** key to go to the next screen menu.



Note:

Use **Right** key to go to next screen menu.

Use **Left** key to go back to previous screen menu.

Use **Ok** key or Select the option to go back to the initial screen on the Tech menu.

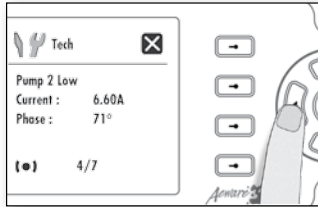

Tech menu

Here Pump 2 low speed current and phase angle are displayed

- Use **Right** key to go to the next screen menu.

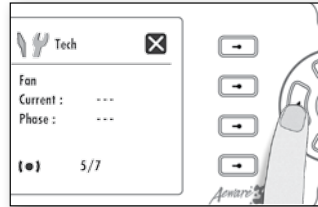

Here Fan current and phase angle are displayed

- Use **Right** key to go to the next screen menu.

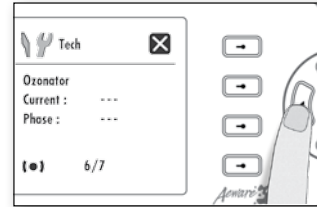

Here Ozonator current and phase angle are displayed

- Use **Right** key to go to the next screen menu.

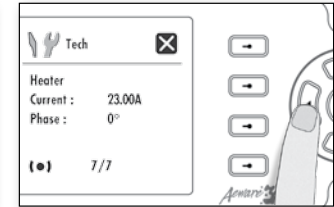

Here Heater current and phase angle (0°) are displayed

- Use **Right** key one last time to go back to keypad main menu.



in.therm

intelligent remote water heating systems

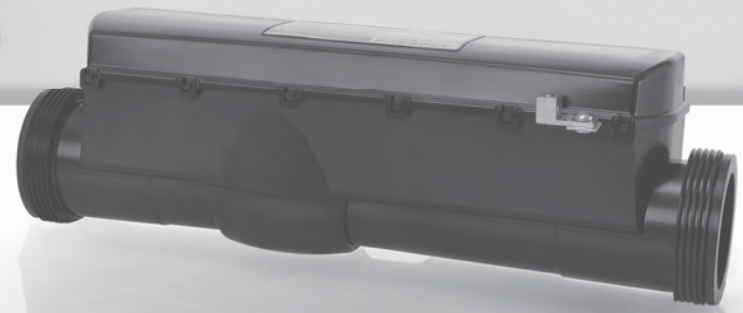

Designed to be totally
maintenance free!

Aeware
by gecko ®





in.therm

Intelligent remote water heating system designed to be totally maintenance free.

Separated from pack, in.therm is an intelligent 4kw remote heater that integrates electronics in its power box. It includes a built-in temperature probe and a new water flow detection feature that eliminates the need of a pressure switch. In.therm controls multiple power levels on a single element extending its lifetime by heating at high power only when needed. With no moving parts and no adjustments, in.therm is hassle free and defines new levels of reliability.

In.therm was designed to be easily and quickly installed. Threads and in.link cables make it easy to connect to pack system & spa pipes.



Totally sealed enclosure
(box & heat channel)

Nominal dimensions: 14,5" x 5" X 4"



Heater installation

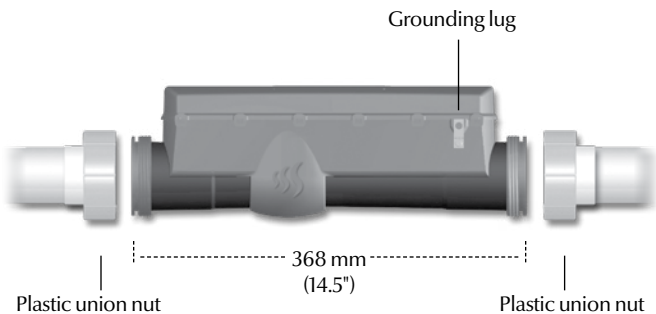

For an optimal connection to spa plumbing, please note that we recommend the following 2" compression fittings & nuts.



Waterway
#400-5570
www.waterwayplastics.com



Aquatemp
86-02335
www.aquatemp.com

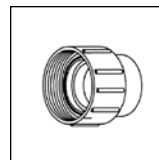

Aqua-Flo
52202000
www.aqua-flo.com

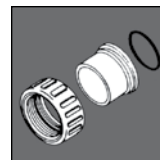

Magic Plastics
#0602-20
www.magicplastics.com



Install heater in the upright position as illustrated above.

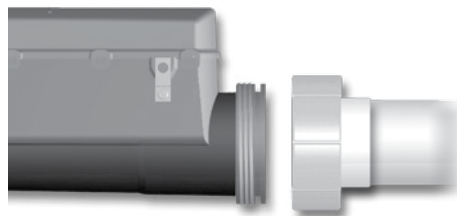

Slide the two 50 mm (2") plastic union nuts over the heater threaded ends and tighten the nuts.

Note: a minimum flow rate of 18 GPM is required.



Connecting in.therm to in.xm2

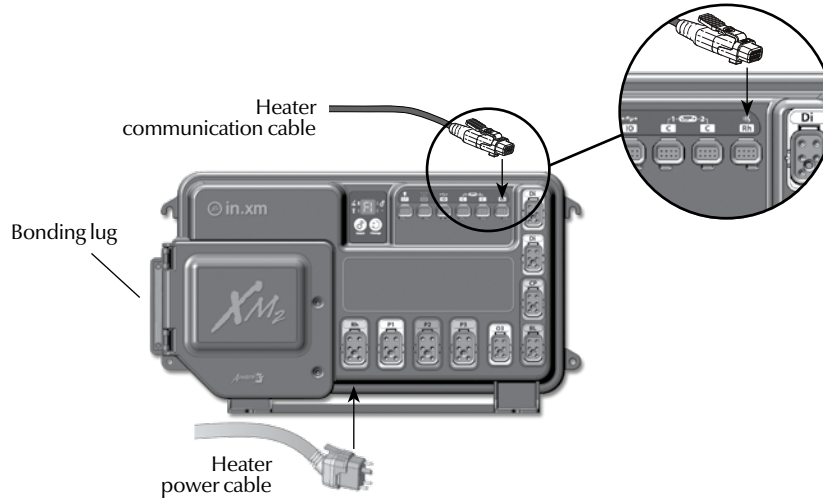

Connect the heater power cable to the in.link output connector indicated Rh on the spa pack.

Connect the heater communication cable to the low voltage connector indicated Rh on the spa pack.

Connect the bonding conductor to the bonding lug on the face of the in.therm.

Important! CE and UL/CSA parts are not interchangeable!



In.xm2 North American electrical specifications:

Input rating: 120/240 VAC (2-phase required, with or without neutral) 48 A maximum, 60Hz.

Input operation specification: 240 VAC (-10% / +5%)

Output ratings:

Output	Voltage	Current	Device
Out 1	240 V	20FLA	Pump 1
Out 2	240 V	15 FLA	Pump 2
Out 3	120/240V	15 FLA	Pump 3 or large Blower
Out 4	120/240V	6 FLA	Aux 1
Out 5	120/240V	6 FLA	Blower
Out 6	120/240V	6 FLA	Circulation Pump (CP)
Out 7	120/240V	6 FLA	Ozone Generator
Out 8	120/240V	6 FLA	Audio/Video device

Important:

- 48 A absolute maximum, distributed on all outputs
- 25 A maximum total for all 120 VAC loads
- 20 A maximum total for OUT2 and OUT3 combined
- 11 A maximum total for OUT4 to OUT8 combined
- Maximum loads are determined by fusing restrictions and ambient temperature. In all output configurations, the total current output must never exceed input ratings.

L1	Light, 1 A / 10 VAC (-5%/+10%) @ 240 VAC / 60Hz
CO	Communications port *
C1	Top side controller *
C2	Top side controller **
IO	General purpose I/O port **

* C1 and CO: 125 mA max on 5 Volts.

** C2 and IO: 125 mA max on 5 Volts.

Important:

- All low voltage accessories use +5Vdc and/or on +12 Vdc.
- All low voltage accessories combined: 300 mA max, on +12 Vdc.



General specifications:

Environmental:

Operating temperature: 0°C (-32°F) to 50°C (122°F)

Storage temperature: -25°C (-13°F) to 85°C (185°F)

Humidity: up to 80% RH, non condensing

Mechanical:

Weight: 3.4 kg (7.6 lbs)

Dimensions (W x H x D):

Chassis: 185mm x 52mm x 275mm (7-1/4" x 2" x 10-3/4")

Standards:

UL 1563 Fifth Ed.

CSA No. 22.2 - 218.1-M89



In.therm supply ratings:

Voltage: 2-phase, 240VAC

Current: 17 A maximum (4 kW heater)

Frequency: 60 Hz

In.therm output ratings:

Heater element: 17A resistive (240 VAC only)

In.therm flow rates:

Minimum of 18 GPM is required



in.xm2.ce electrical specifications:

Input ratings :	1-phase 230-240 VAC (all loads line to neutral)
	2-phase 230-240 VAC (all loads line to neutral)
	3-phase 230-240 VAC (all loads line to neutral)
	1 x 40 A maximum (Single-phase)
	2 x 20A maximum (Dual-phase)
	3 x 16A maximum (Three-phase)
	Frequency: 50HZ

Input operation specification: 230 VAC nominal (-10% / + 6%)

Output ratings:

Output	Voltage	Current	Device
Out 1	230 VAC	15 FLA	Pump 3
Out 2	230 VAC	15 FLA	Pump 2
Out 3	230 VAC	15 FLA	Pump 1
Out 4	230 VAC	6 FLA	General Purpose
Out 5	230 VAC	6 FLA	Blower
Out 6	230 VAC	6 FLA	Circulation Pump
Out 7	230 VAC	6 FLA	Ozone
Out 8	230 VAC	6 FLA	Audio/Video device

Important:

- 48 A (3 x 16 A) absolute maximum, distributed on all outputs
- 16 A maximum total for heater and OUT 1 combined
- 16 A maximum total for OUT 2 and OUT 4 & OUT 5 combined
- 16 A maximum total for OUT 3 to OUT 6 & OUT 8 combined
- Maximum loads are determined by fusing restrictions and ambient temperature. In all output configurations, the total current output must never exceed input ratings.

L1	Light, 1 A / 9.5 VAC (-5%/+10%) @ 230 VAC / 50 Hz
CO	Communications port *
CI	Top side controller *
C2	Top side controller **
IO	General purpose I/O port **

* CI and CO: 125 mA max on 5 Volts.

** C2 and IO: 125 mA max on 5 Volts.

Important:

- All low voltage accessories use + 5Vdc and/or + 12 Vdc.
- All low voltage accessories combined: 300 mA max, on + 12 Vdc.



General specifications:

Environmental:

Operating temperature: 0°C (-32°F) to 50°C (122°F)

Storage temperature: -25°C (-13°F) to 85°C (185°F)

Humidity: up to 80% RH, non condensing

Mechanical:

Weight: 3.4 kg (7.6 lbs)

Dimensions (W x H x D):

Chassis: 185mm x 52mm x 275mm (7-1/4" x 2" x 10-3/4")

Standards:

EN/IEC 60335 - 2 - 60: 2003/2002 - EN/IEC 60335 - 1: 2002/2001
(incl. Corr. & Am. up to 2008)

EN55014-1

EN55014-2

EN61000-3-2

EN61000-3-3

AS/NZS 3136:2001 +A1 +A2

AS/NZS 3100:2002 + A1+A2+A3

in.therm.ce ratings:

Voltage: 230-240 VAC

Power output: 3.8 kW (16 A maximum @ 240 VAC)

Also available: 2.0 kW (8.3 A maximum @ 240VAC)

Frequency: 50 Hz

in.therm.ce flow rates:

Minimum of 18 GPM required



Advanced electronics! Water resistance!



Gecko Alliance

450 des Canetons, Quebec City (QC) G2E 5W6 Canada, 1.800.78.GECKO
9225 Stellar Court, Corona, CA 92883 USA, 951.667.2000

www.geckoalliance.com

9919-101164-E
Rev.12/2014

© Groupe Gecko Alliance Inc., 2014
All trademarks or registered trademarks
are the property of their respective owners.

